

OWNER'S MANUAL



TSC P-12

TSC G-12

TSC G-12c

DIGITAL SPEED CONTROLS
with VARITORQUE™ and
NEW **QuickTUNE**™ Setup

TEKIN



- QuickTUNE™ Electronic Tuning
 - Gives precise setup in seconds
- TCP Throttle Priority Circuit
 - Guarantees full bottom-end power
- Replaceable wires
- High Frequency Linear Current Motordrive
 - Makes your motor's commutator last 2 to 5 times longer,
while also extending run time by 15-25%
- CoolSwitch high efficiency operation - now on all models.
- Uses TEKIN's Universal Connector System
- Built-In 32 Amp Schottky Diode

Congratulations on the purchase of your TEKIN speed control. The TEKIN TSC P-12, G-12 and G-12c use a patented ultra-efficient design based on the 1994 World Champion 411-G2. They combine TEKIN'S exclusive Throttle Priority Circuitry (TPC) which guarantees full bottom-end power under the most severe of conditions, and QuickTUNE™ automated electronic setup, along with super-smooth operation and extremely high power handing to deliver the best in-the-car performance. The G-12c also features shunted MosFETs for vanishingly low resistance and further boosted power output.

<u>Specifications:</u>	<u>TSC G-12, 12c</u>	<u>TSC P-12</u>
ON Resistance	.00125 ohm	.0025 ohm
Current Rating (min)	350 Amps	300 Amps
Braking Current (min)	120 Amps	100 Amps
Input Power	4 -12 Cells	
BEC Volts/Amps	6.0V / 5.0A High Power	
Limiter Current	20 -120 Amps and bypass (MAX)	
Dimensions	1.7 x 1.4 x .6 inch	
Weight	1.7 Ounces	
Power Wires	(3) 12 Gauge Silicone	
Fuse	Zeo-Loss Solder Link	
Plugs (user installed)	Aitronics/Sanwa, Futaba J, JR, KO Propo and Kyosho Pulsar	

Specifications are subject to change without notice.

Install Large Heatsinks Here

Install Small

****Do not let the two heatsinks touch****

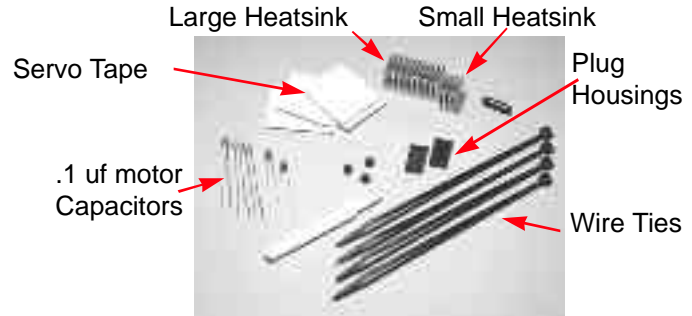
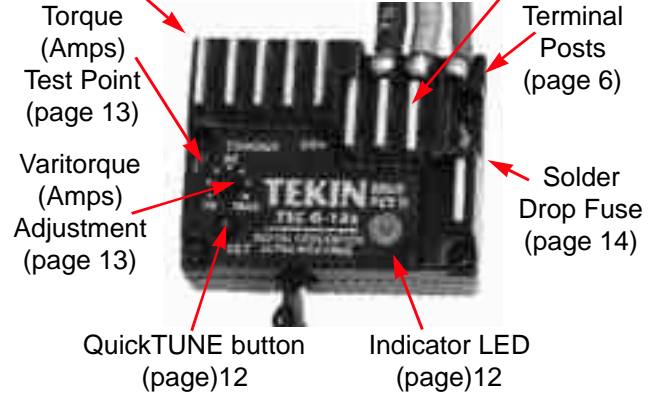

4 Step 1 - CONNECTOR SELECTION

This speed control features the Tekin Universal Radio Connector System. This allows you to use it with Tekin, Airtronics/Sanwa, Futaba J, JR, KO Propo, and Kyosho Pulsar R/C receivers.

The standard connector on this unit is the Tekin / Futaba J. If your receiver is a Tekin or a Futaba, then the standard plug will fit without modification.

When using this speed control with Airtronics, JR, KO Propo, or Kyosho receivers, follow the steps below:

****NOTE:** Kyosho Receivers use the “JR” plug housing**

- 1) First, disconnect the battery from the speed control. Using a small hobby knife or jeweler’s screwdriver, press in the three metal tabs only far enough that each of the wires can be removed from the black plastic plug housing. (figure 1, step A)
- 2) After removing the wires from the receiver plug, use a hobby knife or jeweler’s screwdriver to lift the metal tabs on each of the wires back up. (Figure 1, step B.)
- 3) Select the plug housing that matches your radio system and insert the wires into the housing. Make sure that you put the wires in according to the lettering on the plastic housing. The red wire goes into “RED”, the black wire goes into “BLK”, and the white wire goes into “WHT” (figure 1, step C). Wires will snap into place when inserted into the plug housing correctly.

Figure 1 - CHANGING PLUG TYPES 5

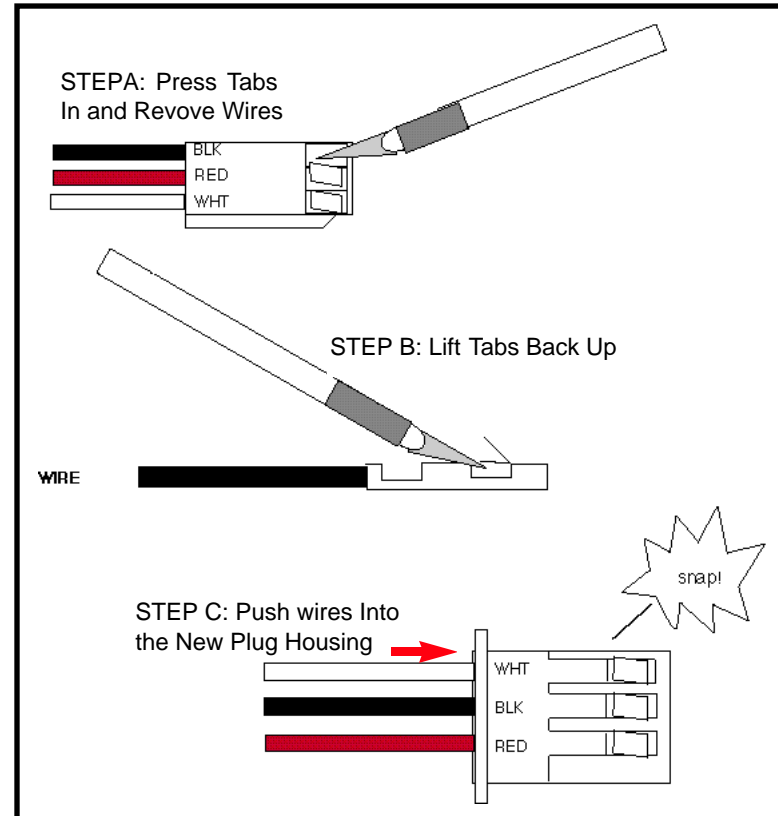

IMPORTANT: As long as the instructions are followed correctly, and proper polarity is observed, changing the motor and battery plugs will not void warranty. **Wiring the plug incorrectly may damage the speed control or radio receiver, and void the warranty.**

- A) Mount the speed control using the provided double-sided tape. Position unit for maximum air-flow over heatsinks. Install the heatsinks by pressing them in place. On the P-12, heatsinks are MANDATORY for all races less than 8 minutes, and for any model which pulls more than 15 amps average current. On the G series they are optional, but do provide slightly better performance. If running dual motors or over 7 cells they are required at all times. DO NOT USE SUPER GLUE or any other type of glue to secure the heatsinks, or damage can result. If heatsinks are fit loose, press the end fins slightly inward to increase tension. Make sure the heatsinks are away from any metal where a short circuit could occur.
- B) Mount the switch with servo tape, supplied screws, or silicone glue. Again, DO NOT USE SUPER GLUE.
- C) On RC10 cars, mount the TSC in the pan and the receiver and antenna on the shock tower to avoid radio interference.

Step 3 - SOLDERING

The wire terminal posts featured on this speed control allow you to run wires of just the right length for any installation without worrying about them becoming too short. The posts are 10GA gold-plated copper for the lowest resistance. If you need to ever change a wire on the speed control, follow the steps below. You will need a very hot soldering iron (750°F to 850°F), and ordinary 60/40 electronic grade solder. **IMPORTANT: Use extreme care and observe proper safety precautions when soldering. Always wear eye protection.** Be sure that both wires are disconnected from the battery before soldering to the posts.

REMOVING A WIRE FROM A POST:

- 1) Have the iron very hot and the speed control secured in place. Clean the tip of the iron and apply a small amount of solder. While the tip is still smoking from the flux in the solder, touch the tip of the iron to the top of the post.

- 2) As the solder on the post melts, pull on the wire you wish to remove. The wire will pull off easily.
- 3) If there is excess solder remaining on the post, you may remove it by heating the post until the solder just starts to melt, then quickly tapping the speed control firmly against the workbench to knock off the excess solder.

ATTACHING A WIRE TO A POST:

Note: Disconnect wires from battery before soldering. Refer to markings on the speed control for proper wire locations.

- 1) Strip back the insulation of the wire by about 3/32 to 1/8" (2 to 3mm) and "pre-tin" the wire by heating the end and applying solder until it is thoroughly covered. You may shake off any excess while it is still hot. Be very careful to not splash yourself with hot solder.
 - 2) If there is no solder on the post, touch the tip of the iron to the top of the post and apply a small amount of solder to the post. Wipe the tip clean and apply a small amount of fresh solder to it.
 - 3) Secure the speed control in place. Hold the wire so the tinned end is in contact with the flat side of the post. Now touch the iron tip to the wire pressing toward the post. Wait about 2 seconds for the solder to flow, then remove the iron while still holding the wire. You may let go after a second or two when the solder sets.
- Note:** It should only take a few seconds to solder a wire to a post. If you do not complete the solder joint in approximately 3 seconds, remove the iron, clean and tin the tip, and start over.
- 4) Inspect the solder joints for shorts or solder bridges between wires, and repair where necessary.

8 Step 4 - MOTOR & BATTERY HOOK-UP

Please exercise extreme care when installing your speed control, as damage can be easily done. Check with your dealer if you think you may need assistance.

NOTES: The speed control supplies power to the receiver and servo. No additional power supply should be used for the receiver (see page 13; "Receiver Packs"). Make sure the battery plug of the receiver is disconnected. Avoid turning on the radio when the batteries are charging.

A) Plug the wire harness from the speed control into the throttle channel of the receiver. The speed control supplies a regulated 5.8 volts to the receiver and servo when running on 4 to 8 cells. The regulator puts out enough current for up to 4 micro servos or 1 high power servo.

B) Wires should be connected as follows:

<u>SPEED CONTROL</u>	<u>BATTERY</u>	<u>MOTOR</u>
Black Wire	(-) Negative	
Light Blue Wire		(-) Negative
Red Wire	(+) Positive	
(Second Red Wire)	(+) Positive	(+) Positive

For maximum motor power, keep the wires as short as practical. If plugs are used be sure there are no exposed pins from the speed control when the motor is unplugged.

Step 5 - TRANSMITTER ADJUSTMENT

Although most any transmitter setting will work with QuickTune, recommended transmitter settings are provided. Check especially the THR EXPO (Throttle Exponential) and REV SW (Servo Reverse Switch) settings for optimum results. (Some transmitter settings can cause more radio interference than others) **Unlisted Transmitters:** All other transmitters are patterned after the ones listed in the chart. Find out which of the models is comparable to your transmitter, and use the adjustments listed for that model.

TRANSMITTER ADJUSTMENT CHART

TX TYPE	*THR EXPO	ATL	ATV HIGH	EPA LOW	THR TRIM	SUB TRIM	REV SW	MECH ADJ	COAST BRAKE
FUTABA									
FP-T2PKA	--	--	6	--	-5	--	Right	Pos. 2	ATVLow
FP-3PG	0	--	5	--	-5	--	NOR	Pos. 2	Brake Trim
FP-T2P	--	--	10	--	-5	--	Rev.	1/2	None
FP-T2PB	--	--	--	--	-5	--	Rev.	Left	None
FP-T2TD	--	--	--	6	Low 5	0	Rev.	1/2	ATL
FP-T2PBKA	--	5	10	10	Low 5	--	Rev.	Left	ATV Low Pot
FP-T2NCS	--	--	10	--	Down	--	--	--	None
FP-T2NBR	--	--	--	--	Down	--	Rev.	Up	None
PCM 1024	-4	--	--	5	N	8	Rev.	1/3	Throttle Trim

AIRTRONICS / SANWA

	--				CW	--	NOR	--	Throttle Trim
3P-FM	--	10	5	CCW	Mid.	--	NOR	--	Throttle Trim
XL-2P	NOR	--	140%	Max.	Mid.	--	NOR	--	Throttle Trim
CS-2P	--	--	Max.	CW	Low	--		Down	None

JR PROPO

VT-2P	--	--	CW	--	Mid.	--	Left	--	Throttle Trim
ALPINA-2	--	--	--	10	CCW	--	NOR	1	None

KO PROPO

PCM	0	--	10	--	Up	0	NOR	--	Trim Tab, Knob
R756	Min.	--	--	B100	Mid.	--	Left	--	CH 2 Trim
EX-1	Min.	--	H100	--	B	--	Left	--	Brake Dial
EX-1 FM	--	--	Max.	--	Mid.	--	Down	--	Brake Trim
EX-II	--	--	CW	--	Mid	--	Up	--	Brake Trim

KYOSHO / PULSAR

EX-5	--	--	Max.	--	CCW	--	Right	Pos. B	None
EX-7	Min.	--	Max.	--	Mid.	--	Down	--	CH 2 Trim
EX-9	--	--	Max.	--			Left		

CCW = Counter Clockwise CW=Clockwise

* Adjust Throttle Exponential control for best balance of low speed and high speed driving power.

BATTERY PACK (4-12 cells)

ALTERNATE CONNECTORS

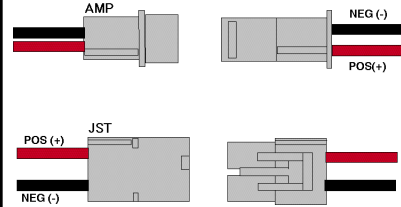

BLUE

MOTOR

Install two .1uf(104) capacitors as shown, from motor terminals to can or center screw. (2.2uf cap is no longer used)

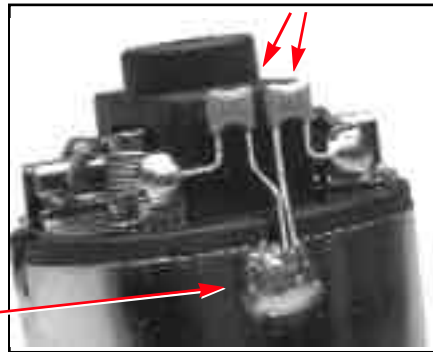

RED

Antenna

RECEIVER

Plug Speed Control into Receiver channel 2, (Throttle)

On/Off Switch. May be mounted using provided screws.

Secure excess wire with tie wraps.

"ON" TAB

SPEED CONTROL

RED

Disconnect battery before soldering to terminal posts.

Scrape away finish for proper solder connection on stock motors.

Once you have completed wiring and hooking up your speed control, it must be calibrated to your transmitter. Tekin's QuickTUNE electronic setup feature allows this to be done quickly, easily and accurately. For optimum performance, first adjust the transmitter according to the chart on page 9, then proceed with the following steps.

- 1) Turn on the transmitter, then the speed control, and leave the transmitter in the neutral position.
- 2) Press and hold the **SET** button for about 5 seconds until the red light starts blinking. Then pull full throttle on the transmitter, then push forward to full brake. Release the trigger. (You have about 5 seconds to do all this). After the light stops blinking, the calibration is complete, and you are ready to drive.
- 3) To adjust the brakes, use the brake trim or EPA / ATL / ATV low adjustment on the transmitter. You may need to do this to reduce the braking somewhat. Whenever you re-set the speed control, be sure to put the transmitter brake trim or EPA / ATL / ATV back to maximum first.

Note: If you do not apply brakes during the calibration procedure, the brakes will be disabled.

HAIRPIN TRIGGER:

If you wish to have a very short trigger range, then only squeeze the throttle trigger partially during the set-up procedure. Throttle response will not be quite as smooth, but you can pull full throttle very quickly.

Race all of TEKIN's expert gear!

Team

BC series Battery
Chargers



TEKIN



Micro
Receivers

Racing

This speed control uses a zero-loss solder-link fuse for the highest performance and coolest operation. This special fuse eliminates the need to replace a fuse or Schottky diode due to an overload or accidental reverse voltage hookup. Instead, you need only replace the solder on the fuse link.

To repair the fuse, use a small-tipped soldering iron, and always wipe the tip off before starting. Touch the tip of the iron to the metal pins on the fuse, then apply a small amount of solder as close to the pins as possible. Hold the iron upright so the solder can drip down the iron onto the pins.

If you apply too much solder, hold the speed control upside down and touch the iron to the solder allowing it to melt and drip down onto the iron tip. Wipe the solder off the tip and start over.

This speed control has its own exclusive circuit with the Schottky diode built in for maximum performance. There is no need to use an external Schottky diode on the motor, although one may be used if desired.

If you follow these simple instructions, your speed control will have a long life of great performance and trouble-free operation.

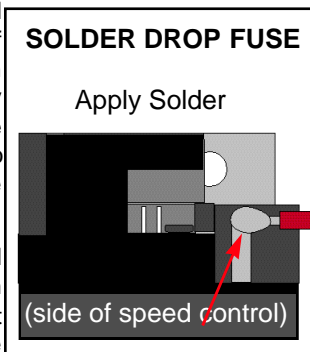

To connect a receiver pack you first need to **turn the speed control OFF**. Then simply plug the battery into the "B" or "BAT" socket on the receiver. **If the Speed Control should get switched on accidentally, it can be damaged and will void the warranty.** A small switch should be used on the receiver pack to operate the radio. The receiver pack should have no more than 5 cells and should be charged on a TEKIN 'BC series' digital charger for best results. A receiver pack is recommended only if you are running your car on 4 cells, or if your car is under weight.

RECEIVER BATTERY PACKS

The TORQUE knob is used to adjust the maximum torque of the motor. On a DC electric motor, torque is proportional to current flow.

This speed control is equipped with an exclusive Tekin test point to accurately check the torque setting. To use the test point you need a digital voltmeter. First, set the meter to the 20V range. Then connect one lead of the meter to the black speed control wire where it connects to the battery (neg), and the other meter lead to the test point. Now turn on the speed control. You may also turn on the transmitter, although it is not necessary. If you are in the pits and cannot turn your transmitter on, you may want to unplug the speed control from the receiver to prevent the car from going crazy. The reading will vary from about 0 to 1.20 volts as you turn the TORQUE knob. The voltage reading directly corresponds to the speed control amperage, (ie. 0 - 1.20 volts equals 0 - 120 amps). 75 amps is a good starting point and is the recommended setting for most applications. If you are in a hurry, the dial on the speed control housing may be used to set the current.

High Torque Applications: Motors intended for such uses as drag racing and pulling, can draw more than 120 amps. If there is good traction and you need maximum amperage, set the torque control to "MAX" by turning the TORQUE knob all the way clockwise. This enables the speed control to supply the peak battery power by bypassing the current limiter.

If you have any sign of radio glitching (the throttle or steering does not always seem to respond to the transmitter correctly), perform this test. To test for radio glitches, turn the car on with fully charged batteries, and hold the rear wheels so the motor is stalled. Apply PARTIAL throttle, and check the steering servo for any movement or jittering. If the servo remains still, the installation is fine, otherwise you will need to move the receiver and/or the battery wires to a different location. Do not run the large battery wires or strap near the receiver.

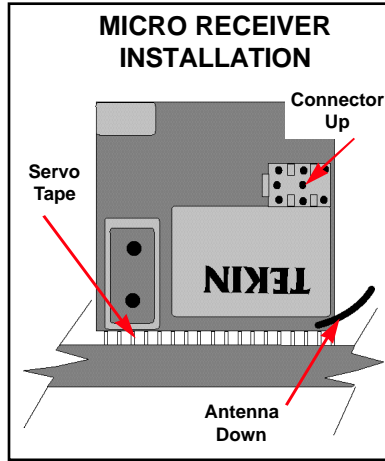

A Tekin Micro Receiver is highly recommended. They are designed to operate down to 2.2 volts, for strong acceleration. It should be mounted on its side as shown in the above illustration. Keep the receiver at least 1/2" away from the batteries and any power wires.

NOTE: If the receiver must be mounted close to the battery or wires, then wrap a small piece of aluminum foil around the receiver to provide additional shielding from radio noise. Also see item 5 on page 16 & 17 for more information on interference.

5) ...continued

Tips: This speed control radiates very low noise and you should have no trouble with interference. If you do have interference, mount the speed control in the pan, and mount the receiver and antenna at the top of the shock tower. Try to keep the receiver away from the batteries or power wires. Also try to space the receiver away from any metal or graphite. Using a double or more thick layer of servo tape helps. Do not run the antenna along a metal or graphite chassis; it should go straight up from where it exits the receiver. It is always a good idea to keep the receiver and antenna away from the motor, batteries, and power wires. Also see page 15.

6) AUTOCOUNT NOT WORKING

Capacitors required on motor. (see pages entitled "Wiring Diagram")
Mount transponder at front of car away from batteries and wires. Move autocount pickup to a place on the track where throttle is wide open (not accelerating). If these do not fix the problem, go to new autocount system.

7) MOTOR WILL NOT SHUT OFF OR RUNS SLOWLY

Moisture in speed control: Unhook batteries and let the speed control dry.

8) SPEED CONTROL SHUTS DOWN

Motor or capacitor shorted, or motor stalled. Motor diode shorted. Gears or transmission are binding.
Speed control overheating: Heatsinks and/or more airflow needed.

9) BRAKES DO NOT WORK AT ALL

Speed control improperly adjusted: Recalibrate (see page 12).

This electronic Speed Control is the most advanced unit available and we believe also the most reliable. As long as it is not abused it will give years of frequent service. In the rare event you do have a problem, fill out the Service Return Card that is included with your unit and proceed as follows.

WARRANTY: Hobby dealers and distributors are not authorized to replace units thought to be defective. Repairs must be returned directly to the factory. A sales receipt must be enclosed. If unit is working properly and you just want it checked over there will be a small inspection charge.

NON WARRANTY: Repairs may be sent directly to the factory. We are not responsible for independent service stations. No estimate is provided. Customer assumes responsibility for charges, which will never exceed 50% of the list price of the unit. Repairs are returned via UPS COD CASH or billed to a Credit Card. **All addresses outside the US require a credit card.** You must enclose a return card or note stating the problem, a legible return address and any special shipping instructions. We cannot return units to a P.O. Box unless payment is sent with the speed control. Hobby Dealers will not replace units thought to be defective, these units must be returned directly to TEKIN ELECTRONICS, Inc. for repair. Estimated repair prices are as follows: Flat rate labor \$8.00, Replace wires \$4.00, Replace switch \$5.00, Replace plug \$5.00, Repair brakes \$6.00, COD \$4.50, 2-Day return shipping \$6.00, Next day return shipping \$15.00, Handling \$3.00. Most repairs are shipped back out within 3 working days. Average total is \$20.00-\$25.00. Please allow sufficient delivery time (up to 2 weeks). Rates subject to change. Sorry, we do not repair non-TEKIN items.

TEKIN SERVICE

940 Calle Negocio
San Clemente, CA 92673
USA

TEKIN ELECTRONICS, INC. guarantees this speed control to be free from factory defects in materials and workmanship for a period of 120 days from date of purchase, when verified by sales receipt. This warranty does not cover: suitability for specific application, components worn by use, application of reverse or improper voltage (fuse provides protection in most cases), tampering, misuse, or shipping. Our warranty liability shall be limited to repairing unit to our original specifications. Because we have no control over the installation or use of this product, in no case shall we be liable for damages.

Additionally, these items void the warranty:

1. Using the same polarity connectors on the battery and motor wires from the Speed Control.
2. Allowing water or moisture into the unit.
3. Incorrect wiring.
4. Not using the heatsink.
5. Use inconsistent with the instructions.

By the act of using this Speed Control, the user accepts all resulting liability.

Copyright 1996 TEKIN ELECTRONICS, INC. Printed in the U.S.A.
QuickTUNE and Varitorque are trademarks of Tekin Electronics

