

# Piper J-3 Cub

## Assembly Manual



### Specifications:

Wingspan: 82.7" (2100mm)  
Length: 48" (1215mm)  
Wing area: 850 in<sup>2</sup> (55dm<sup>2</sup>)  
Weight: 6.5-7.5lbs (3-3.5kg)  
Engine: .46-.61 2 Cycle  
.50-.91 4 Cycle  
Radio: 4 Channel (5 Servos)

### Thunder Tiger Piper J-3 Cub ARF Airplane (TTR4532)

Distributed in North America by Ace Hobby Distributors, Inc. • 116 W 19th ST, Higginsville, MO 64037  
Phone: 660-584-7121 • www.acehobby.com • E-mail: acehobby@ctcis.net

### Warranty

This kit is guaranteed to be free from defects in material and workmanship at the date of purchase. It does not cover any damage caused by use or modification. The warranty does not extend beyond the product itself and is limited only to the original cost of the kit. By the act of building this user-assembled kit, the user accepts all resulting liability for damage caused by the final product. If the buyer is not prepared to accept this liability, it can be returned new and unused to the place of purchase for a refund.

### Notice: Adult Supervision Required

This is not a toy. Assembly and flying of this product requires adult supervision.

Read through this book completely and become familiar with the assembly and flight of this airplane. Inspect all parts for completeness and damage. If you encounter any problems, call 660-584-6724 for help.



# INTRODUCTION



One of the most recognized names in aviation history is the Piper J-3 Cub. A child of the Depression, Mr. Piper's Cub began production in the early '30s, evolving into the 65 HP J-3 version in 1939. Proliferating in the years before and during WWII, the Cub has introduced more young men to the joys of flight than any other airplane ever.

Now you can own a part of aviation's history and enjoy the relaxing and realistic flight characteristics of the venerable J-3 Cub. Thunder Tiger's ARF J-3 has been meticulously built from the finest material and covered with UltraCote® in the classic Cub Yellow color scheme. Scale details such as wing struts, landing gear bungees, Cub wheels, accurately contoured fuselage, and dummy engine cylinder heads create a head-turning beauty. Only a few hours of enjoyable assembly and you are ready to step back in time and be a part of history by flying the classic, IMAA legal J-3 Cub.

## PRE-ASSEMBLY NOTES

Before beginning the assembly read the instructions thoroughly to give an understanding of the sequence of steps and a general awareness of the recommended assembly procedures.

By following these instructions carefully and referring to the corresponding pictures, the assembly of your model will be both enjoyable and rewarding. The result will be a well built, easy to assemble A.R.F. model, which you will be proud to display and also provide you flying excitement not unlike its full-scale counterpart.

If you are not an experienced R/C pilot, plan to have a fully competent pilot check your completed model and help you with your first flights. Even though we have tried to provide you with a very thorough instruction manual, R/C models are rather complicated and an experienced modeler can quickly check over your model to help make sure your first flights are successful. Your J-3 Cub is designed for intermediate to advanced pilots.

Before you begin, check the entire contents of your kit against the parts list and photos to make sure that no parts are missing or damaged. This will also help you to become familiar with each component of your plane. If you find that any of the parts are either missing or damaged, please contact Ace Hobby Distributors, Inc., Customer Service (660-584-6704) immediately for replacements.

**Note: Neither your dealer nor Ace Hobby Distributors, Inc., can accept kits for return if construction has begun.**

Trial fit each part before gluing it in place. Make sure you are using the correct part and that it fits well before assembling. No amount of glue can make up for a poor-fitting part.

### TABLE OF CONTENTS

Introduction . . . . .	2
Other Items Required . . . . .	2
Items Needed Check List . . . . .	3
Parts Sketches . . . . .	4-5
Wing Assembly . . . . .	6-9
Fuselage Assembly . . . . .	10-12
Stabilizer Assembly . . . . .	12-14
Engine & Fuel Tank Installation . . . . .	14-15
Radio Installation . . . . .	16-18
Cowl Installation . . . . .	19
Windshield Installation . . . . .	20
Wing Strut Attachment . . . . .	20-21
Balance . . . . .	21
Control Throws . . . . .	21
Flying Hints . . . . .	22
Pre-Flight Checks . . . . .	22
Safety Precautions . . . . .	22
Post-Flight Check List . . . . .	22

## Adhesives:

Instant setting Cyanoacrylate adhesive (thin CA)  
 Slow setting Cyanoacrylate adhesive (thick CA)  
 10 Minute Epoxy (fast)  
 20-30 Minute Epoxy (slow)  
 R/C 56 Glue

## Tools:

Model knife, T-Pins, 1/2" vinyl tape  
 Small screwdrivers, Medium screwdrivers  
 Scissors  
 Steel straight edge  
 Long nose pliers and diagonal cutting pliers  
 Drill and drill bits  
 Sanding block  
 Fine felt tip pen and soft lead pencil  
 Straight building board

## R/C System:

4 Channel radio with 5 servos

## Engine:

2 cycle: .40 to .61 CID  
 4 cycle: .50 to .91 CID

Propeller (appropriate for engine type and preferred performance)



**Adhesives** - You will need two types of adhesives for the Fun Tiger - Epoxy and Instant (cyanoacrylate) adhesives. We recommend that you purchase both 5-minute and 30-minute epoxy to cut down on assembly time, but you can get by with only 30-minute epoxy if time is not important. You will also need a small bottle of both "Thick" and "Thin" instant adhesive.





**Tools** - Model assembly can be much easier if the proper tools are used. Therefore, we have included in our checklist to the left, a complete listing of all the tools we used to assemble our prototype models. As you will notice, many household tools can be utilized during construction.

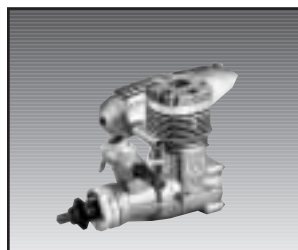

**Radio** - A 4-channel radio with five standard servos is required.

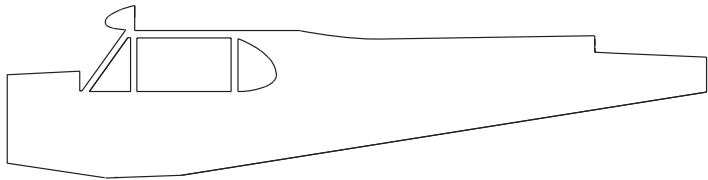
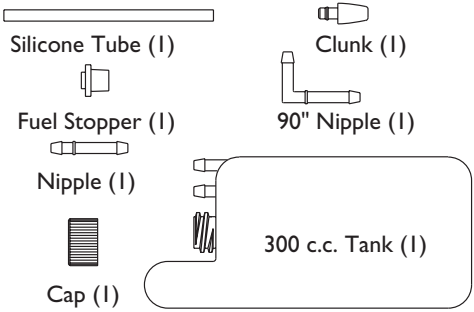
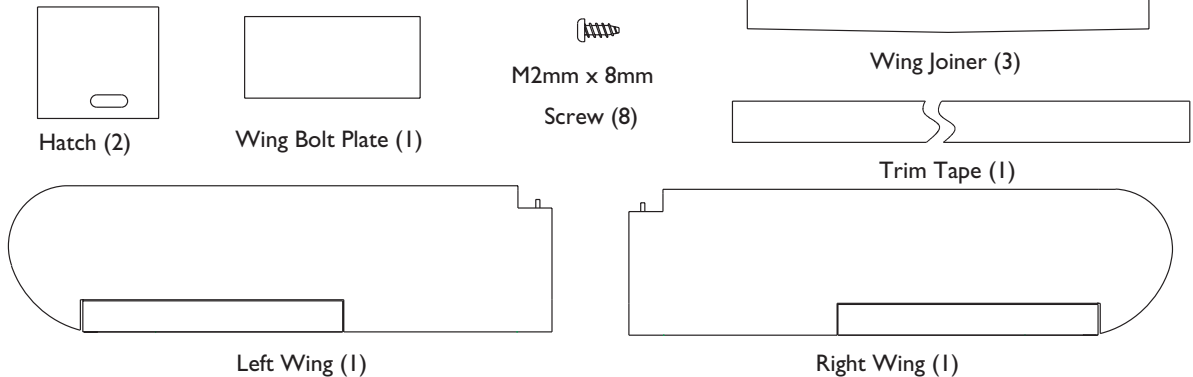
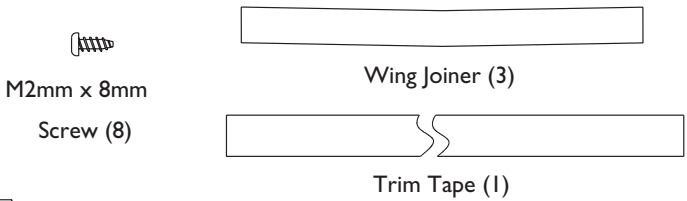
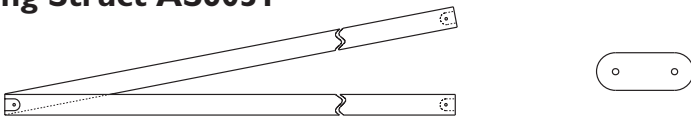
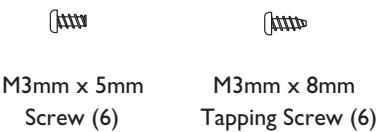
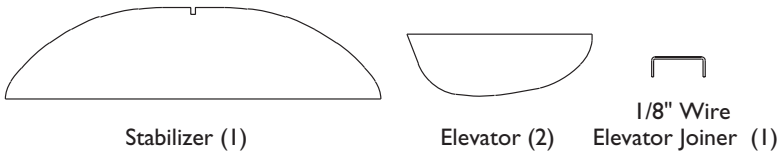
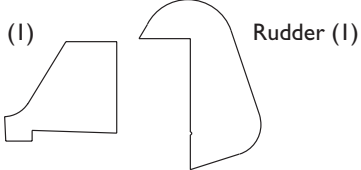

**Engine** - The Thunder Tiger PRO-46 and F-54S are the ideal engines for this airplane. These quiet-running engines are easy to start, require no special break-in periods, are very easy to maintain and will last for years.

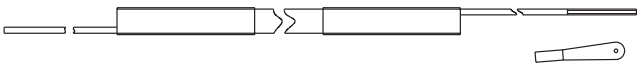
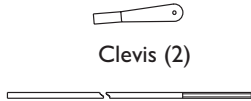
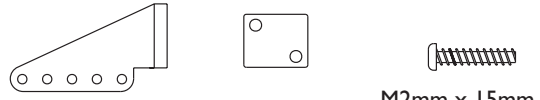
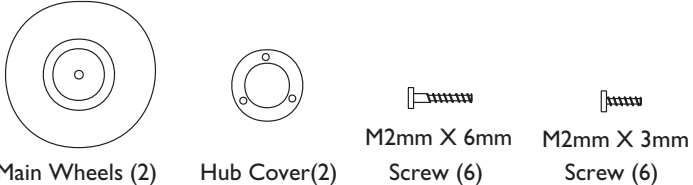
<h3>Fuselage AS6029</h3>  <p>Fuselage(1)</p>		<h3>Fuel Tank Set #3263</h3>  <p>Silicone Tube (1)          Fuel Stopper (1)          Nipple (1)          Cap (1)          Clunk (1)          90° Nipple (1)          300 c.c. Tank (1)</p>	
<h3>Wing AS6030</h3>  <p>Hatch (2)          Wing Bolt Plate (1)          Left Wing (1)          Right Wing (1)</p>		 <p>M2mm x 8mm Screw (8)          Wing Joiner (3)          Trim Tape (1)</p>	
<h3>Wing Struct AS6031</h3>  <p>Wing Struct (2)          Mounting Plate (6)</p>		 <p>M3mm x 5mm Screw (6)          M3mm x 8mm Tapping Screw (6)</p>	
<h3>Horizontal Tail AS6032</h3>  <p>Stabilizer (1)          Elevator (2)          1/8" Wire Elevator Joiner (1)</p>		<h3>Vertical Tail AS6033</h3>  <p>Vertical Fin (1)          Rudder (1)</p>	
<h3>Shrink tube AS6034</h3>  <p>Shrink tube (4)</p>	<h3>Aft Pushrods AS6035</h3>  <p>Stab/Rudder Pushrods(2)          Clevis (2)</p>		<h3>Aileron Pushrods #3152</h3>  <p>Clevis (2)          Threaded Rod (2)</p>
<h3>Control Horn Set #3151</h3>  <p>Control Horn (2)          Back Plate (2)          M2mm x 15mm Screw (4)</p>		<h3>Main wheel #3101</h3>  <p>Main Wheels (2)          Hub Cover(2)          M2mm X 6mm Screw (6)          M2mm X 3mm Screw (6)</p>	

## Main Landing Gear AS6036

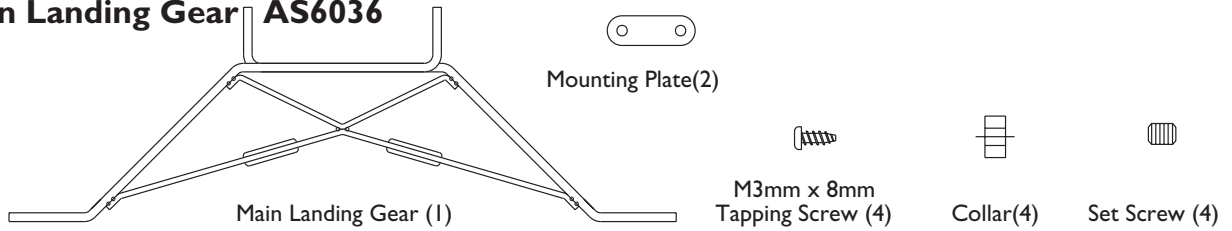

## Tail Wheel AS6037

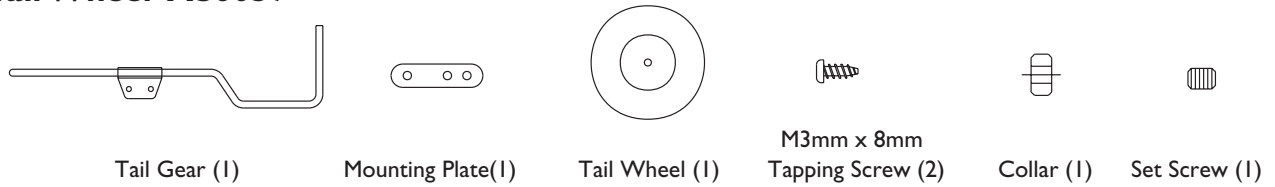

## Landing Gear Fairing AS6038

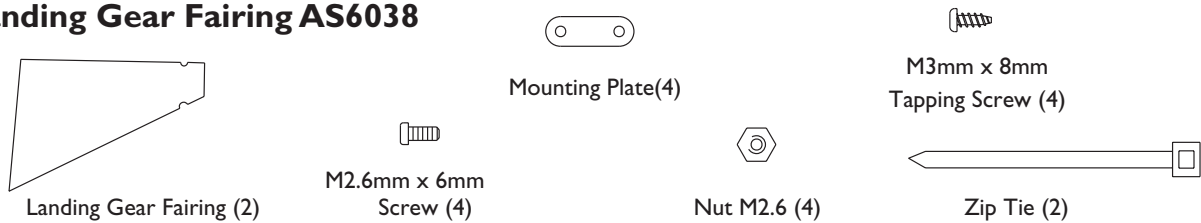

## Engine Mount #3103

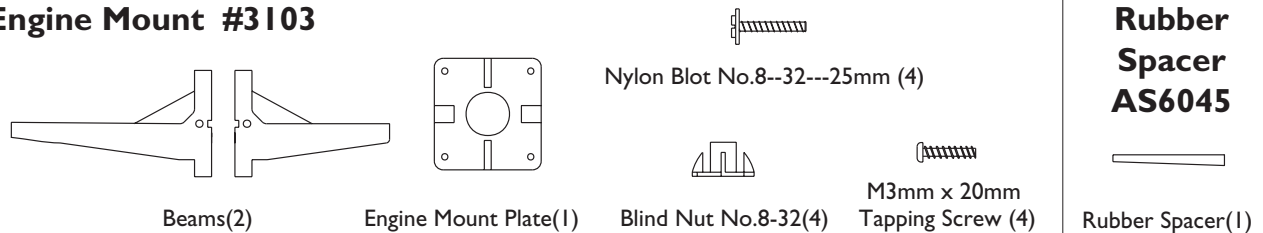

## Canopy AS6039

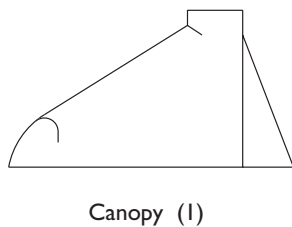

## Cowling AS6040

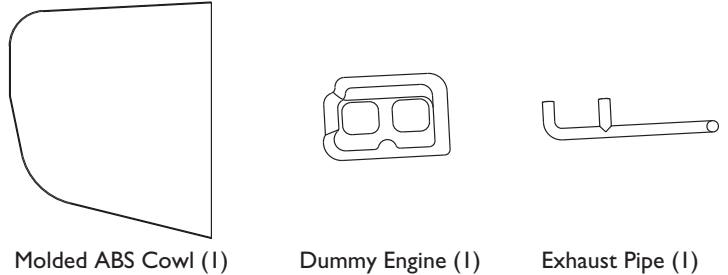

## Decal AS6041



Registered Number Decal (1)



Cub Decal (1)

## Forward Pushrods AS6042

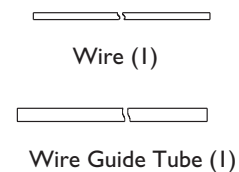

## Control Horn Set AS6043

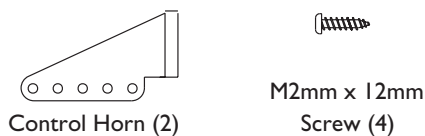

## Nylon Blot Set AS6044



# WING ASSEMBLY

☐ Identify the right and left wing panels. Carefully remove the tape that temporarily secures the ailerons to each wing panel.

☐ Carefully remove all hinges from the ailerons and apply a small drop of oil to each hinge on the hinge pin. (Photo 1)

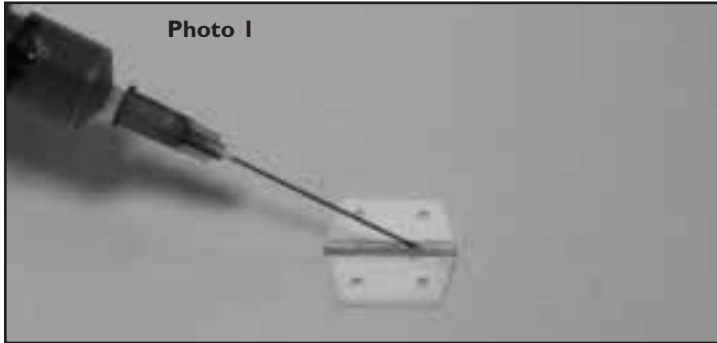

☐ Apply 20-30 Minute Epoxy to one half of each hinge and insert into the right aileron. Set aside to cure and repeat procedure for the left aileron. (Photo 2)



☐ Apply 20-30 Minute Epoxy to the exposed portion of the hinges on the right aileron. Carefully fit the aileron into the right wing panel. Wipe off any excess epoxy using denatured (rubbing) alcohol. Set aside to cure. Repeat the same procedure for the left wing aileron and wing panel. (Photo 3)

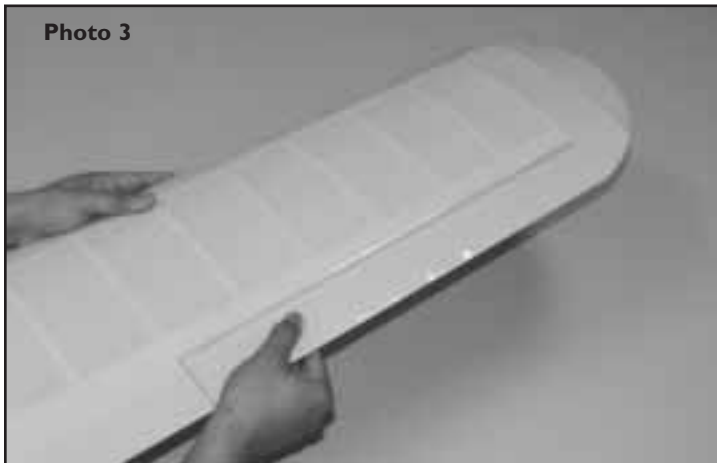

☐ Place the right wing panel upside down on the building board. Locate the exit hole for the aileron extension. Using a model knife, carefully cut and remove the covering material covering the exit hole. Repeat the procedure for the left wing panel. (Photo 4)

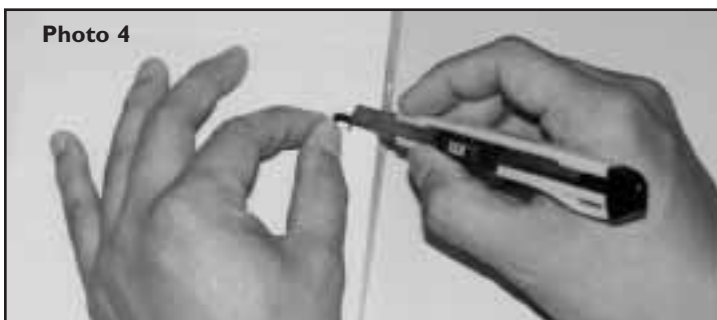

☐ With the right wing panel once again upside down on the building board, determine the aileron servo location (2nd wing bay in from the inboard edge of the aileron). Using a felt tip pen, draw a cutting line 3/16" inside the bay. Carefully cut away the covering and seal the edges using a heating iron. (Photos 5, 6 & 7)

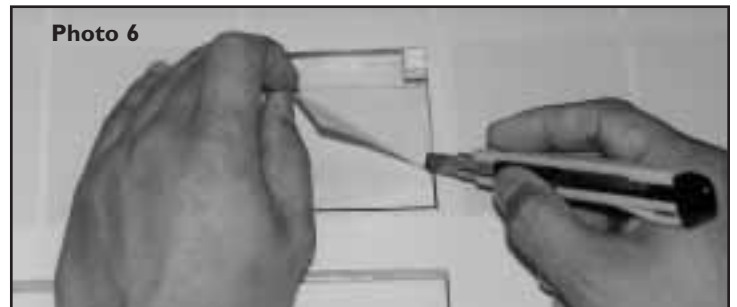
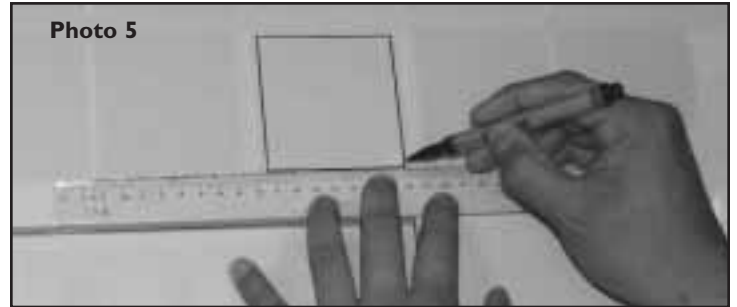

☐ Obtain two servo extensions that give you the necessary lead length for your aileron servos (12" or so). Join the aileron servo and servo extension. Cover the connection with heat shrink tubing provided and using a heat gun shrink the tubing over the connectors. (Photo 8).

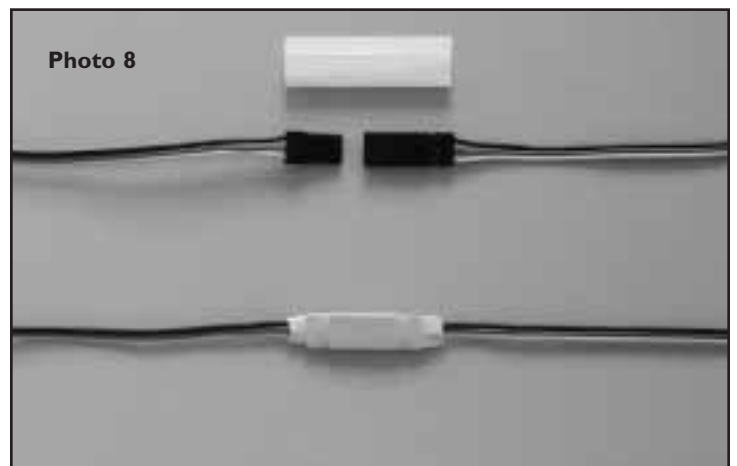

- Insert a piece of piano wire through the root rib of the wing panel and “fish” the aileron servo lead through the wing. (Photos 9 & 10)

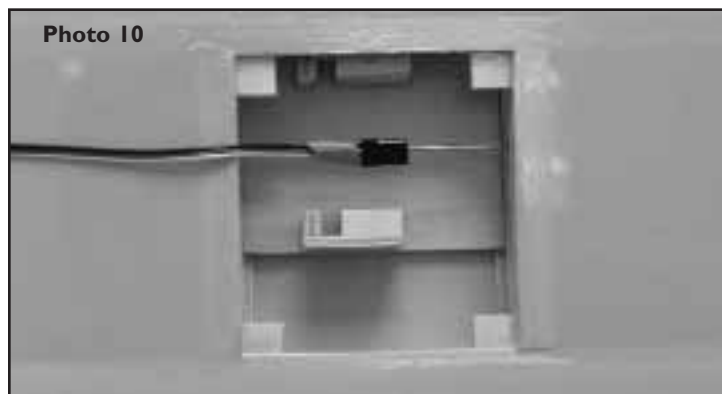
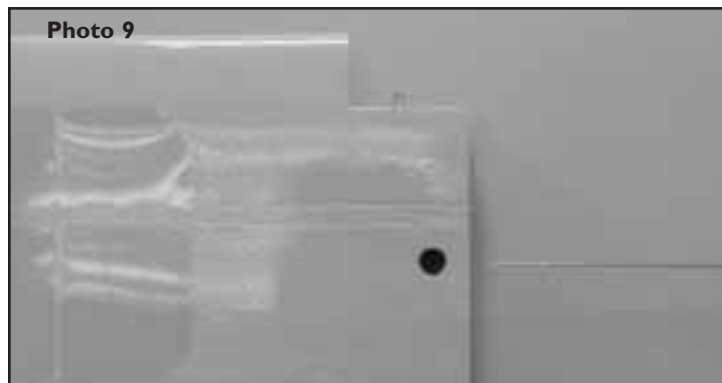

- Use a pair of tweezers to pull the servo lead through the exit hole in the wing panel (Photo 11).

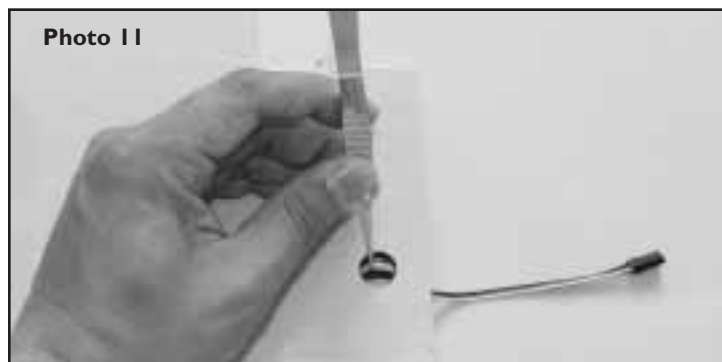

- Place the servo in the wing panel in the servo mount. (Photo 12)

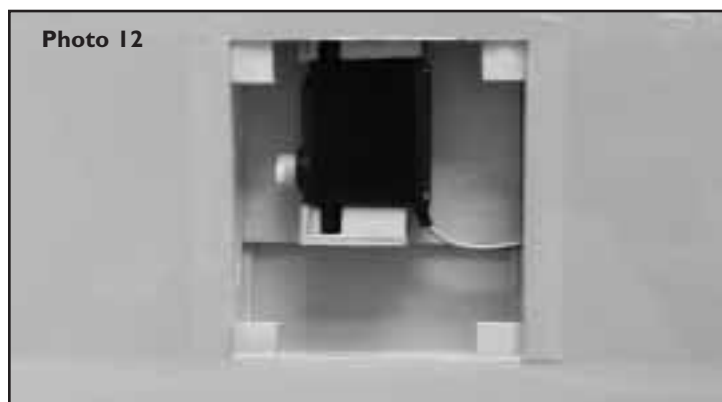

- Place the servo hold down plate over the servo and drill through the plate into the servo mount taking caution not to drill through the wing. (Photo 13)

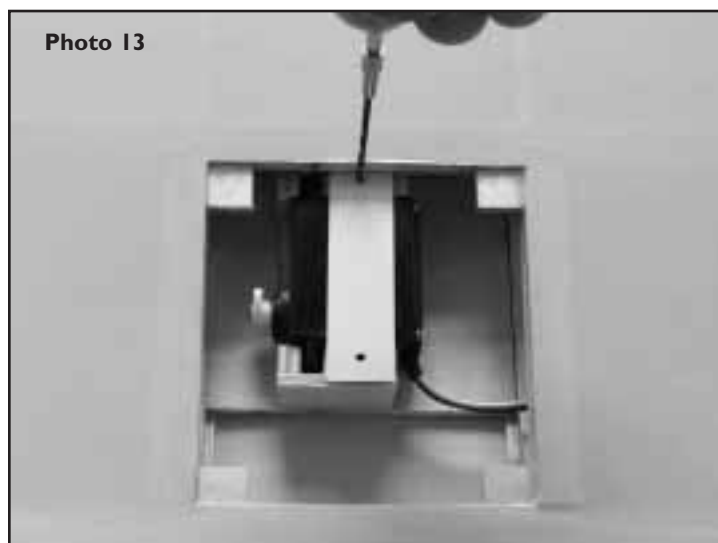

- Using M2.5X8 wood screws, screw the servo hold down plate in place (Photo 14)

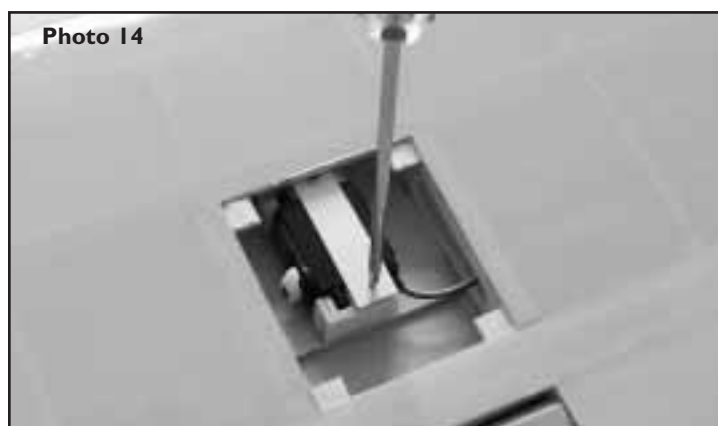

- Locate the correct servo cover and install in the right wing panel.
- Drill 4 3/64” holes at the four corners. (Photo 15)

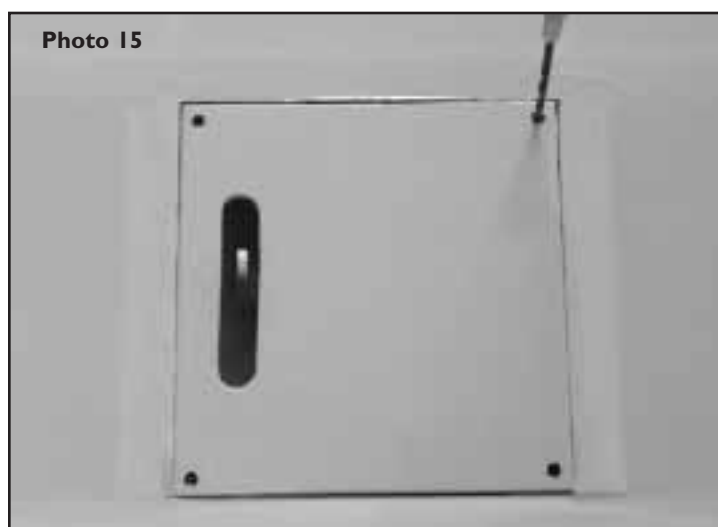

# WING ASSEMBLY

□ Place the control horn on the aileron and align with the servo horn slot in the hatch cover. Drill holes using the control horn as a template. Secure the control horn with two M2x12 screws and the backer plate. (Photo 16)

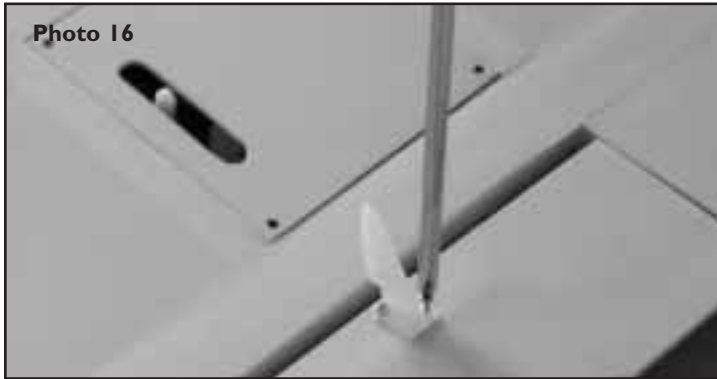

□ Locate the control clevis and thread onto the push rod. Snap the clevis onto the control with the servo at the neutral position. Mark the clevis for the "Z" bend. (Photo 17)



□ Remove the clevis, cut off the excess wire and insert the "Z" bend through the hatch cover then into the servo horn. Snap the clevis onto the control horn. Secure the hatch cover with 4 M2x8 wood screws. (Photos 18 & 19)

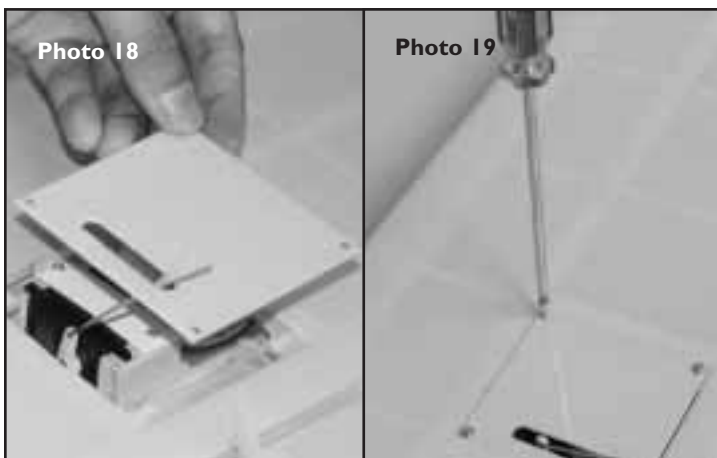

□ Repeat the above procedures for the left wing panel.

SUGGESTION: Secure any clevis/control horn connection with a piece of medium fuel tubing about 1/4" long. (Not Shown)

□ Locate the three wing joiners (2 plywood and 1 aluminum). Apply a coat of 5-10 Minute Epoxy to each side of the aluminum joiner and mate the 2 plywood joiner to it. Clamp the assembly together and set aside to cure. (Photos 20 & 21)

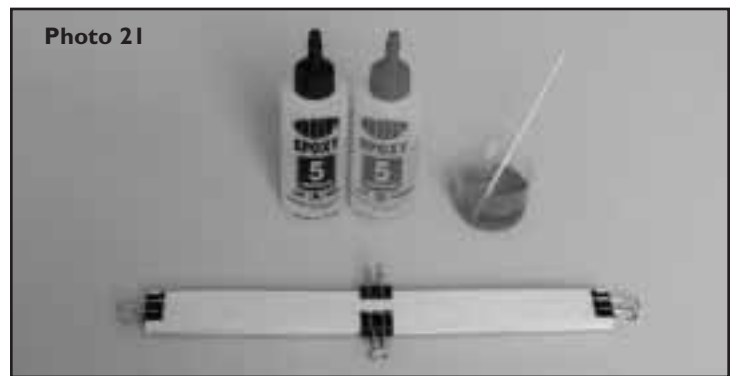

□ Draw a center line on the wing joiner and trial fit into the spar box on each wing panel. Sand to fit as necessary. (Photo 22)



□ When the two wing panels match up perfectly, apply 30-45 Minute Epoxy to the wing joiner on one half only. Liberally apply 30-45 Minute Epoxy to the spar box in the right wing panel. Insert the joiner into the spar box wiping off any excess epoxy. Set aside to cure. (Photo 23)





□ Apply 30-45 Minute Epoxy to the left wing panel spar box as well as the entire root rib. Carefully join the two wing panels together. Wipe off any excess epoxy. Block up each wing tip 5/8" and allow to cure. It may be necessary to use masking tape to hold the wing panels in position until cured. (Photo 24)



□ Use the hardwood wing bolt plate as a template. Draw a reference line on the top of the wing at the trailing edge. Using a hobby knife carefully cut the covering and remove from the wing. Use caution not to cut into the wing skin. (Photo 25)

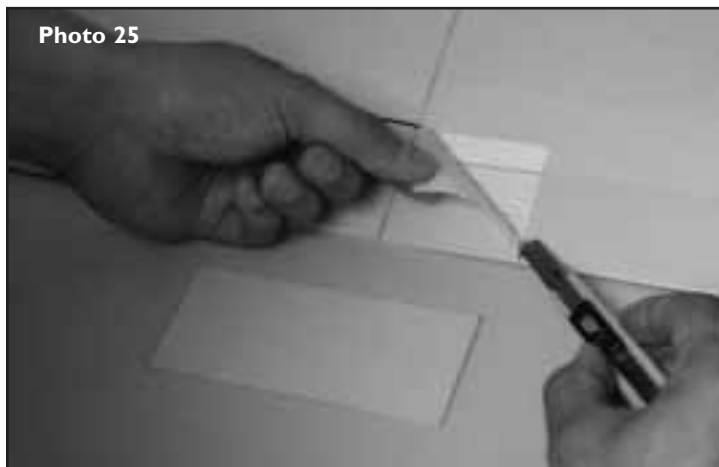

□ Using 5-10 Minute Epoxy, glue the hardwood wing bolt plate into place. Locate and mark a reference point 5/8" in from each side and 1-3/8" up from the trailing edge of the wing. Using a 9/32" (7mm) drill, drill a hole through the wing at each reference mark. (Photo 26)



□ Place the wing on the fuselage. Carefully align the wing ensuring that it is centered on the fuselage. Using a 19/64" (7.4mm) drill bit, drill through the wing into the wing hold down plate in the fuselage using the previously drilled holes as a reference. (Photo 27)



□ Remove the wing from the fuselage. Install the blind nuts in the bottom of the wing hold down mounting plate. Install the wing hold screws in the blind nuts and pull up tightly ensuring that the blind nuts are secured in place. (Photo 28)



□ Remove the wing bolts and trial mount the wing to the fuselage. Adjust as necessary to ensure proper alignment. (Photo 29)

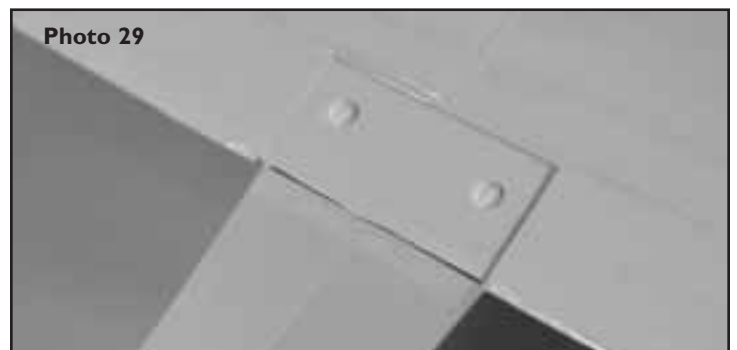

□ Remove the wing and cover the center joint with the trim covering provided.

# FUSELAGE ASSEMBLY

☐ Carefully cut away the covering over the landing gear slot on the bottom of the fuselage. (Photo 30)



☐ Position the preformed landing gear in place. Locate the landing gear retaining plates (2) and place them over the landing gear. Using a felt tip pen mark the location for the mounting screws. (Photo 31)

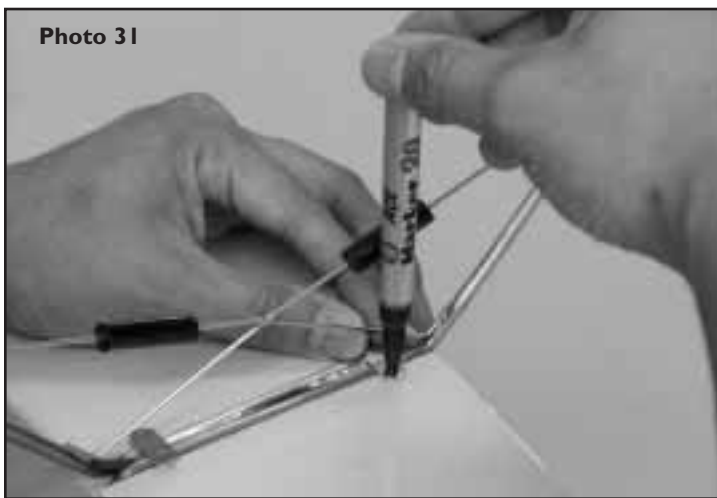

☐ Remove the landing gear and drill 4 5/64" (2mm) holes. (Photo 32)



☐ Reinstall the landing gear and secure it in place with 4 M3x8 wood screws. (Photo 33)

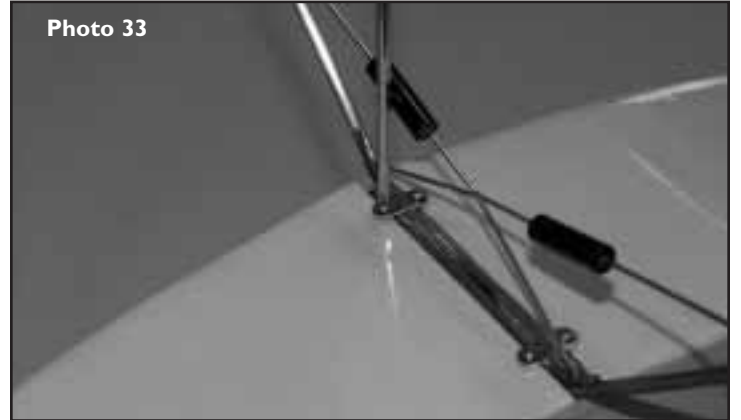

☐ Locate the Cub Wheels and secure the hub in place with the provided screws. (Photo 34)

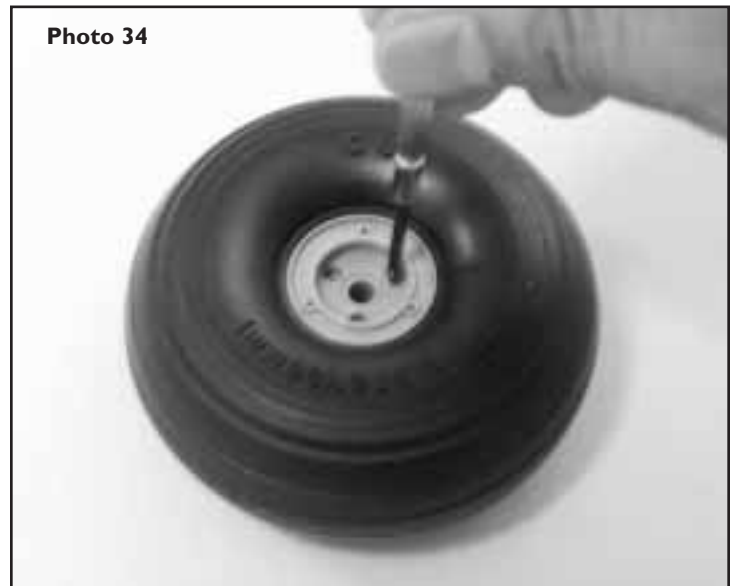

☐ Insert a 5mm-wheel collar (w/set screw) onto the landing gear. Do not tighten at this time (Photo 35)



# FUSELAGE ASSEMBLY

- Install the Cub Wheel followed by another 5mm-wheel collar. Ensure that the wheel collar is even with the edge of the landing gear axle and secure it in place with the “L” wrench provided. (Photo 36)



Photo 36

- Place the hubcap on the Cub Wheel and mount it in place with the small screws provided. Secure the original wheel collar against the back of the Cub Wheel allowing freedom of motion without being too loose. (Photo 37)



Photo 37

- Locate the pre-covered landing gear fairings. Drill 2 7/64” (2.6mm) holes as shown. (Photo 38)

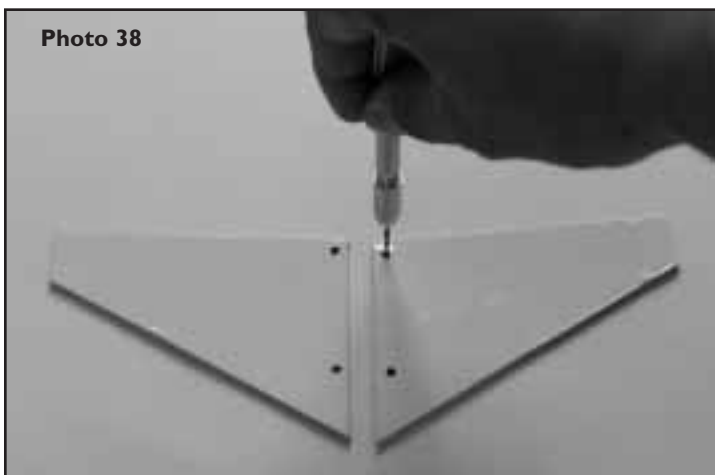

Photo 38

- Carefully bend the mounting plates to a 45-degree angle then secure to the fairings with M2.6x6 screws and M2.6 nuts. (Photo 39)



Photo 39

- Hold the landing gear fairing in place. Using a felt tip pen mark the location on the fuselage for the mounting screw. Ensure that the landing gear fairing is located underneath the bottom/corner of the fuselage. (Photo 40)



Photo 40

- Drill 5/64” (2mm) holes at the marked locations. (Photo 41)

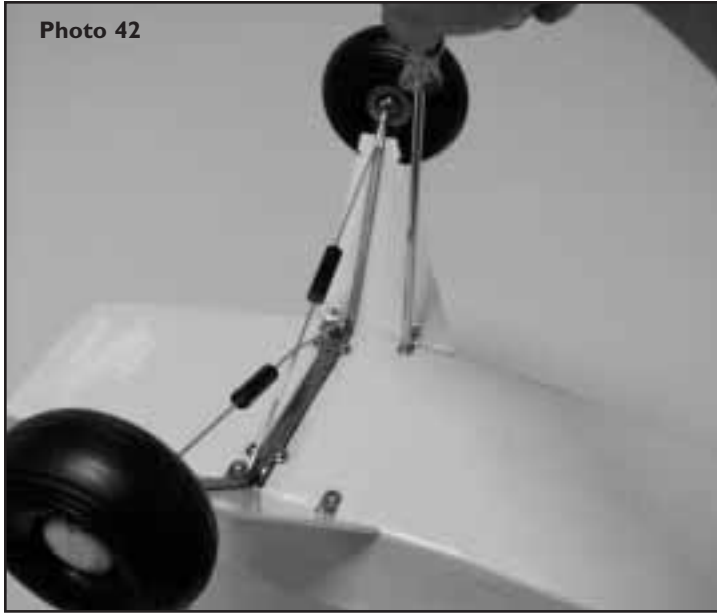

Photo 41

# FUSELAGE ASSEMBLY/STABILIZER ASSEMBLY



☐ Mount the landing gear fairings in place using 4 M3x8 wood screws. (Photo 42)



☐ Secure the lower portion of the landing gear fairings to the landing gear using the small nylon tie wraps provided. (Photo 43)



☐ Attach the elevator joiner wire to each elevator half with thick CA or 5 minute epoxy. (Photo 45)



☐ Remove the hinges from the horizontal stabilizer and apply a drop of oil to each hinge. Apply 10-20 minute epoxy to one side of each hinge and install in each elevator half. Set aside to cure. (Photo 46)



☐ Apply 10-20 minute epoxy to the hinges on the elevators and install them on the horizontal stabilizer. Allow curing then cut a notch in the covering at the center leading edge for the vertical stabilizer. (Photo 47)



## STABILIZER ASSEMBLY

☐ Locate both elevator halves. Carefully cut away the covering on the elevators where the wire elevator joiner is to be installed (Photo 44)



☐ At the rear of the fuselage locate the positions for the horizontal and vertical stabilizers. Using a hobby knife carefully cut away the covering over these areas. (Photo 48)



## STABILIZER ASSEMBLY

- Temporarily install the horizontal and vertical stabilizers (in that order). Using a felt tip pen mark the fuselage location on both the horizontal and vertical stabilizers. (Photo 49)



- Remove the horizontal and vertical stabilizers from the fuselage. Using a hobby knife cut the covering along the marked lines being careful not to cut in the wood which could result in structural failure. (Photo 50)

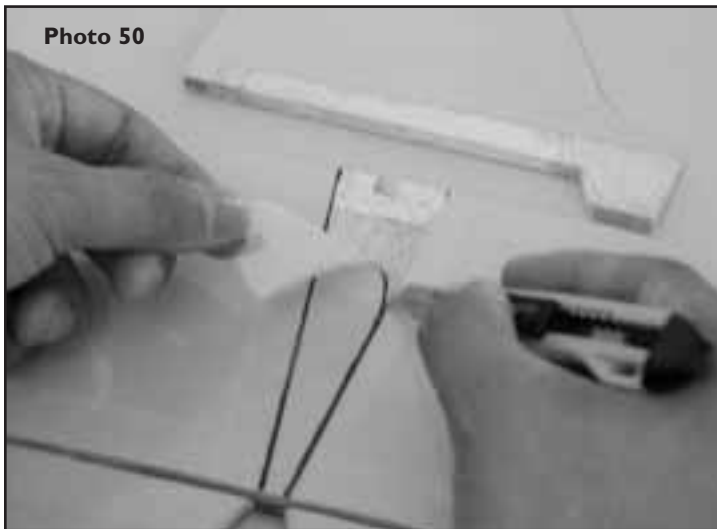

- Mount the wing to the fuselage. Using 30-45 minute epoxy, install the horizontal and vertical stabilizers in position. Ensure that the horizontal stabilizer is parallel with the wing and that the vertical stabilizer is 90-degrees to the horizontal stabilizer. Set aside until cured.

- Locate the tail wheel wire hole on the rudder. Cut a slot in the fuselage for the tail wheel gear wire hinge. (Photo 51)



- Cut a slot on the leading edge of the rudder. Trial fit the tail wheel gear wire to the rudder. Cut a notch in the leading edge of the rudder to allow clearance for the elevator joiner wire (Photo 52)



- Locate the hinges for the rudder and place a drop of oil on each hinge joint. Using 10-20 minute epoxy apply epoxy to one side of the hinges and install them into the rudder. Install the tail wheel gear wire into the rudder at this time also using epoxy. Set aside until cured. (Photo 53)

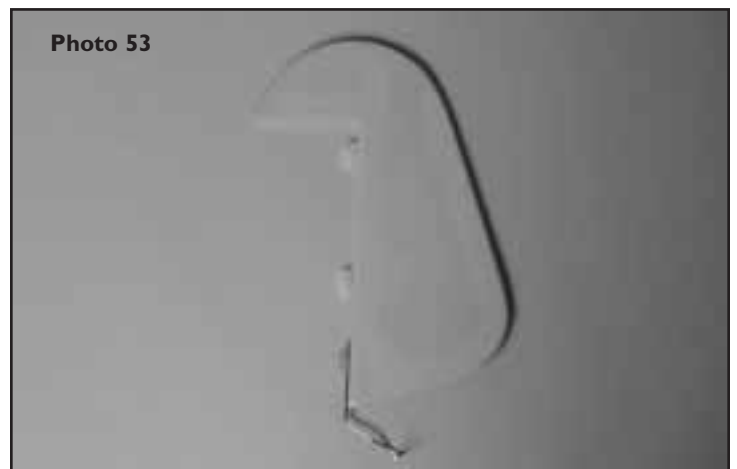

- Apply 10-20 minute epoxy to the hinges and install the rudder and tail wheel gear wire into the vertical stabilizer and fuselage respectively. Press together as tightly as possible to ensure minimal gap between the rudder and vertical stabilizer. Install the tail wheel mounting plate as shown with 2 M3x8 wood screws. (Photo 54).



## STABILIZER ASSEMBLY

- ❑ Install the tail wheel and secure in place with the provided wheel collar. (Photo 55)

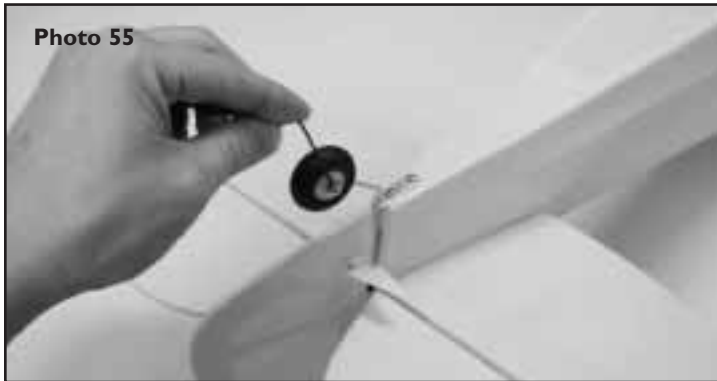

- ❑ Locate the elevator control horn on the right elevator with the clevis holes in line with the hinge line. Drill  $2\ 5/64"$  (2mm) holes using the control horn base as a template. Secure the elevator control horn to the elevator using 2 M2x15 screws and the control horn backplate. (Photo 56)



- ❑ Using the same procedure as for the elevator control horn, install the rudder control on the left side of the rudder. (Photo 57)



## ENGINE & FUEL TANK INST.

- ❑ Locate the adjustable engine mount. Hold in place on the fuselage firewall and verify fit. Mount the engine mount to the firewall but do not secure it in place at this time. (Photo 58)



- ❑ Assemble the fuel tank as shown taking care to insure that the fuel tank clunk is not restricted in motion. (Photo 59)



- ❑ Cut three 6-8" pieces of standard fuel tubing to length. Install them on the fuel tank nipples and install the fuel tank in the fuel tank compartment. Note that it is easier to feed the lines through the firewall if they are tied together with a piece of line and pulled through. (Photo 60)

- ❑ Secure the tank in place with small foam blocks or foam rubber. (Photo 61)

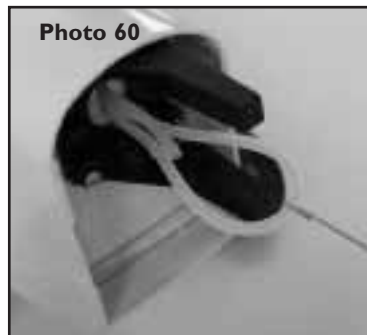

- ❑ Install the throttle push-rod tube through the firewall and into the radio compartment. (Photo 62)



- ❑ Leave approximately 1/4" of the push-rod tube extending into the engine compartment. Epoxy in place. (Photo 63)

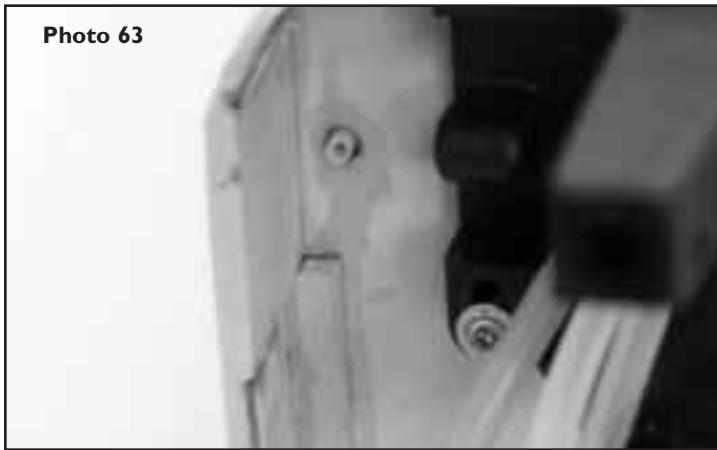

- ❑ Place the engine on the adjustable motor mount and locate the front drive hub 4-13/16" from the firewall. Mark the mounting hole locations on the motor mount. (Photo 64)



- ❑ Remove the engine and drill a 5/64" (2mm) hole at each of the marks. (Photo 65)

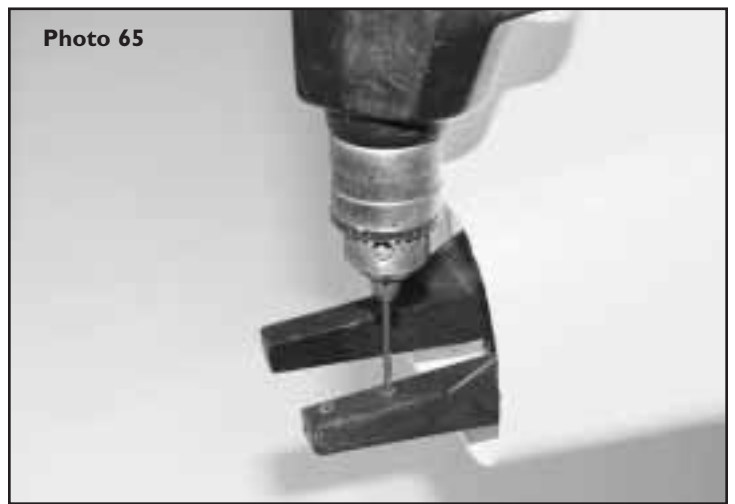

- ❑ Secure the engine to the motor mount using the 4 M3x20 self-tapping screws provided. (Photo 66)

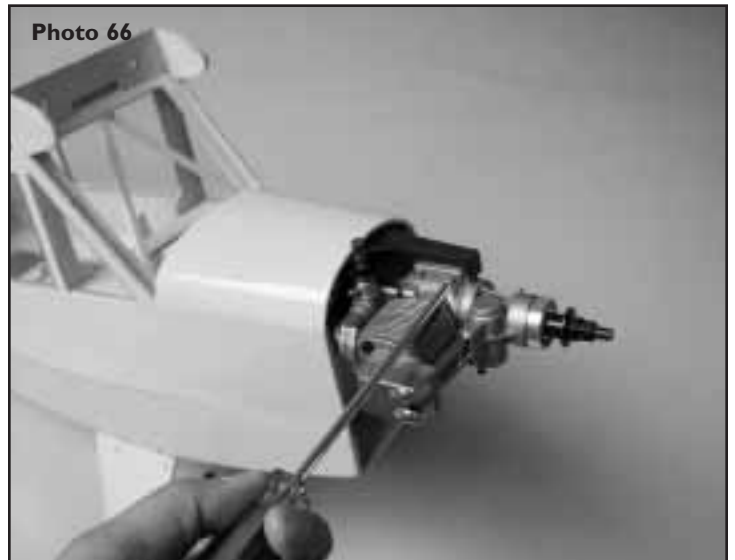

- ❑ If installing the recommended Thunder Tiger F-54S engine, extend the choke valve wire insuring that it is long enough to clear the cowling. (Photo 67)

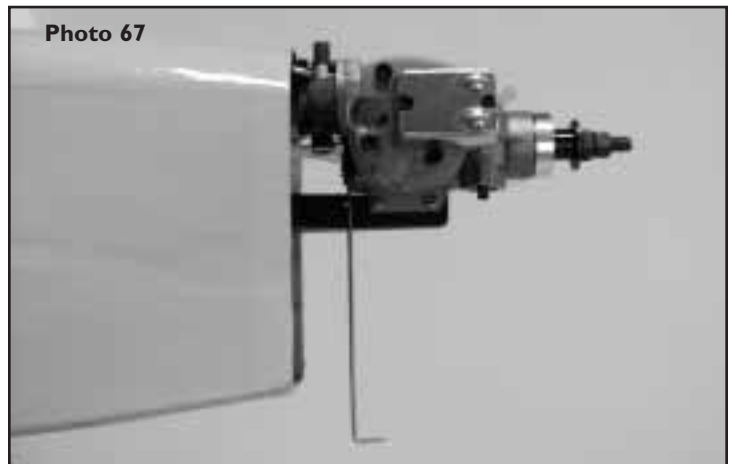

# RADIO INSTALLATION

- Install the switch harness as shown. Wrap the battery pack in foam and install underneath the fuel tank (Photo 68). You may have to adjust the battery location to obtain the proper CG.

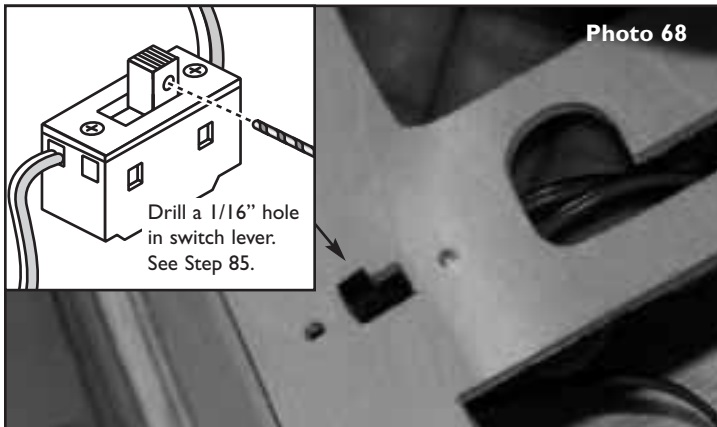

- Locate the antenna guide tube exit at the rear of the fuselage on the bottom and remove the covering around the exit hole using a hobby knife (Photo 69).



- Insert the receiver antenna through the guide tube located under the servo tray. Leave approximately 2" (5cm) of the antenna extending outside the exit (Photos 70 & 71).

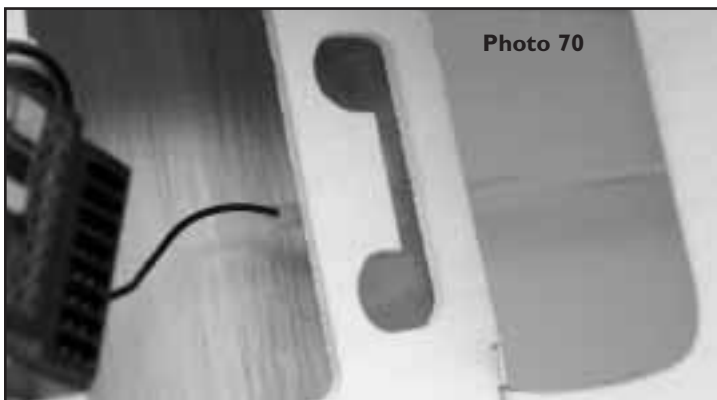

- Install the three servos in the radio compartment (throttle, rudder, and elevator). From the tail facing forward from right to left, the servos are throttle, rudder and elevator. Plug the servos into the receiver and set neutral. (Photo 72)



- Install the EZ connector on the throttle servo horn. Place the servo horn on the servo (Photo 73).

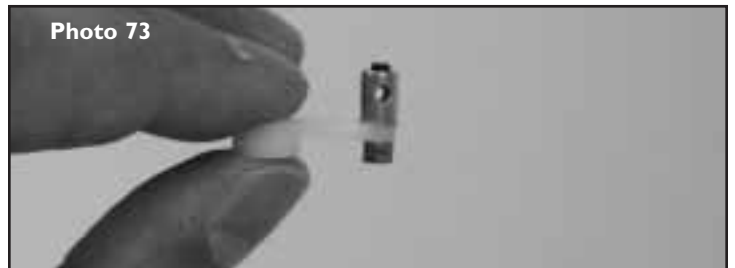

- Remove the throttle lever from the engine. Make a "Z" bend at one end of the push rod and install it on the throttle lever (Photo 74).

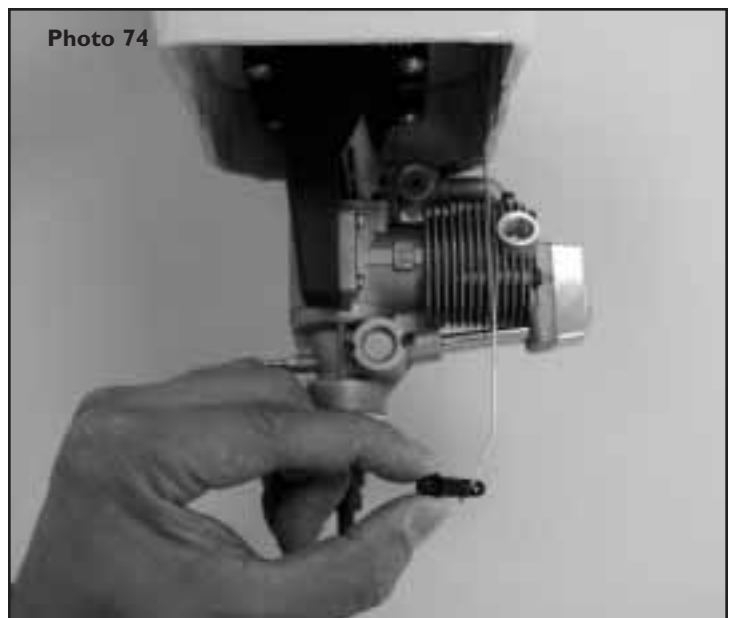



- ❑ Install the other end of the throttle push rod in the EZ connector. Trim off any excess wire (Photo 75).



- ❑ Using a hobby knife carefully cut away the covering over the elevator and rudder push-rod exits at the rear of the fuselage (Photo 76).



- ❑ Install one push rod with the threaded end first through the fuselage and exiting at the elevator exit slot. Locate a clevis and thread it onto the threaded end at least 20 turns. Snap the clevis onto the control horn at the 3rd hole from the bottom (Photo 77).



- ❑ Mark the other end of the push rod where the "Z" bend is to be located (Photo 78).

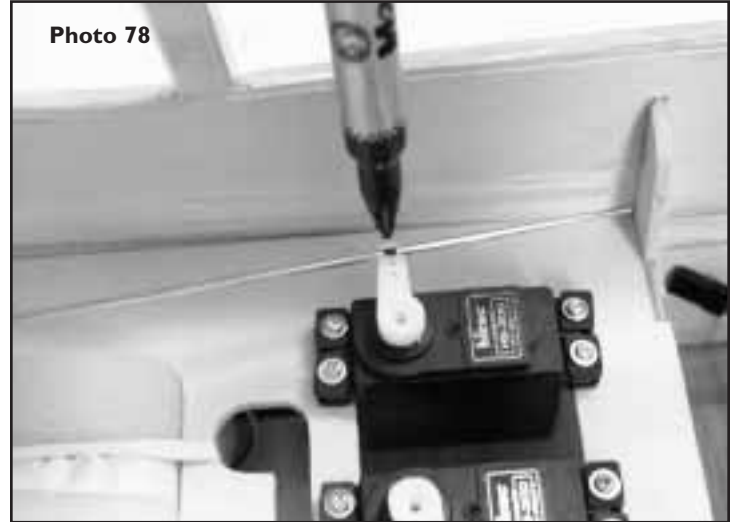

- ❑ Using "Z" Bend Pliers bend the push rod at the location marked (Photo 79).



- ❑ Insert the "Z" bend into the servo horn. Install the servo horn on the servo (Photo 80).



# RADIO INSTALLATION

□ Install the rudder push rod using the same steps as for the elevator. (Photos 81, 82, and 83)

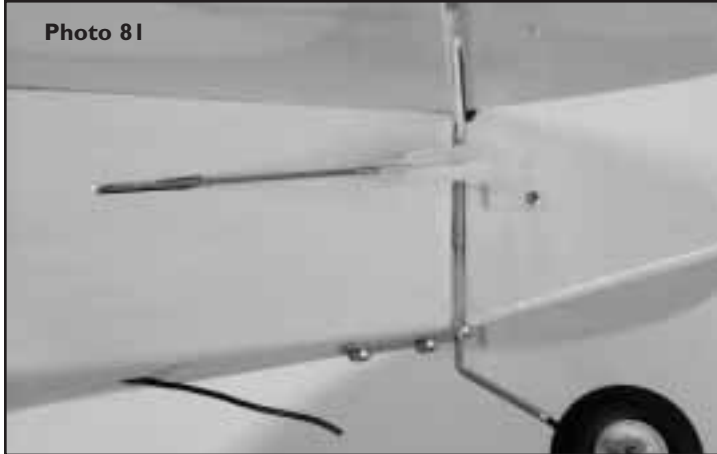

Photo 81

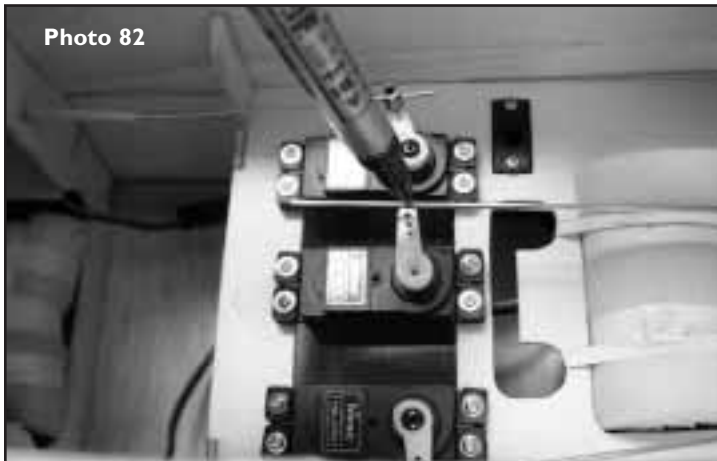

Photo 82



Photo 83

Using a piece of the excess wire bend an extension for the on-off switch. (Photo 84)



Photo 84

□ Drill a small hole through the fuselage in line with the switch. Insert the extension wire through the fuselage and place in the switch. Using needle nose pliers bend the wire to prevent it from coming loose. (Photos 85 & 86)

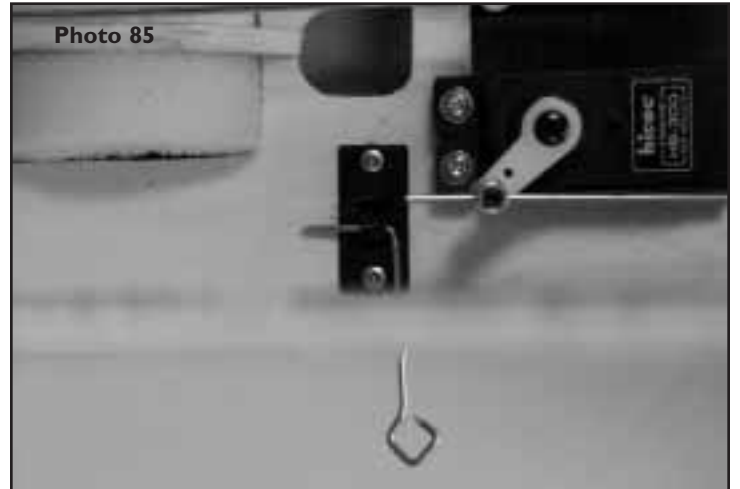

Photo 85

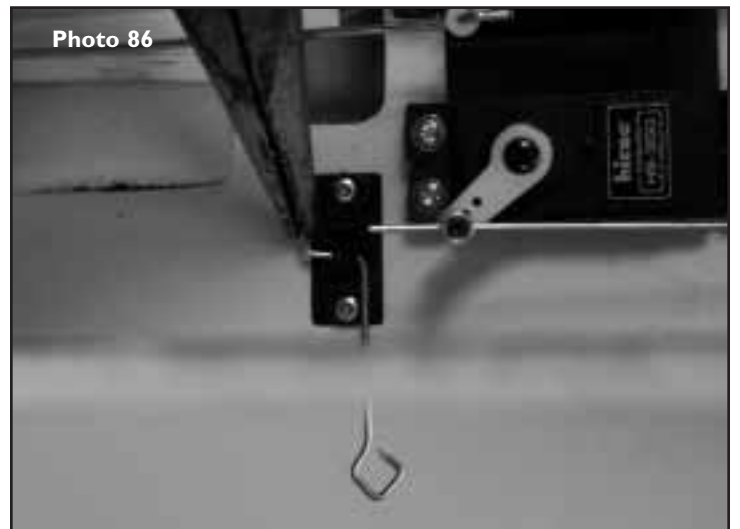

Photo 86

□ Cut the cowling along the molded cutting line. Measure the cowl for the engine to be used and cut the appropriate openings. (Photo 87)



Photo 87

# COWL INSTALLATION

- ☐ You may need to make a cut behind the engine cylinder head to allow the cowling to go into place with minimal effort. (Photo 88)

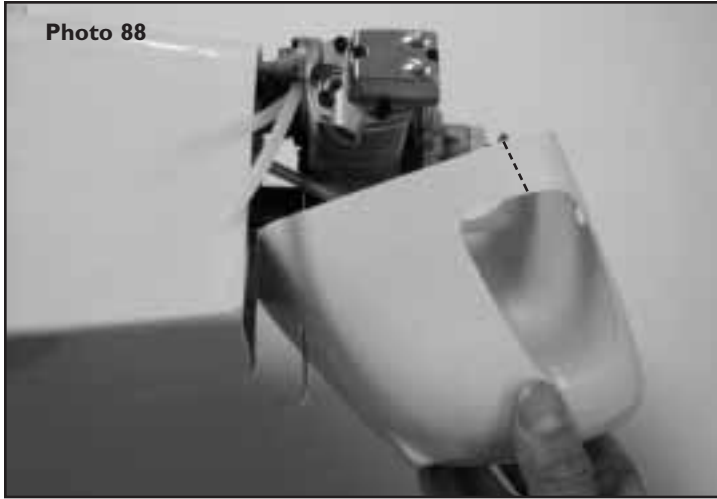

- ☐ With the cowl in position cut a hole for the needle valve and route the fuel line out of the cowling (Photo 89).

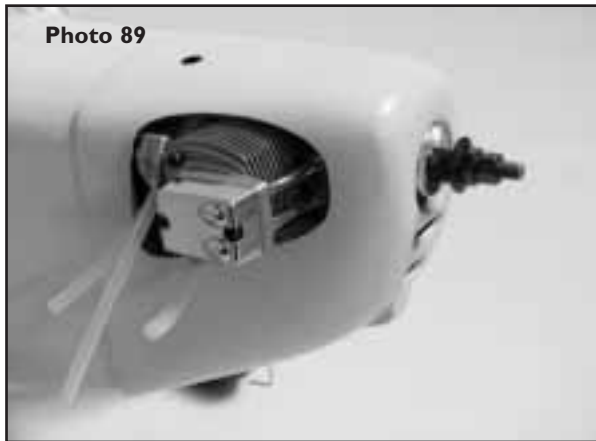

- ☐ Install the header pipe and muffler (Photo 90).

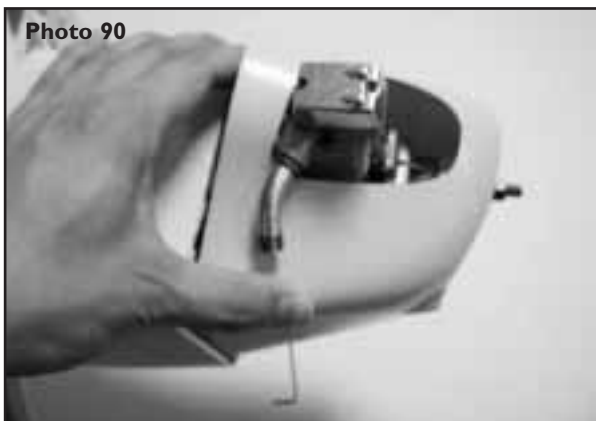

- ☐ Position the cowl and drill 3 1/16" (1.5mm) holes on both sides (Photo 91).



- ☐ Secure the cowl with 6 M2.5x8 wood screws. Route fuel lines from the cowl. One is the fuel filler line and the other goes to the muffler pressure fitting. The final line is from the engine breather fitting (4-cycle) and vents via a piece of aluminum tubing held in place on the muffler with small tie wraps (Photo 92).



- ☐ Install the dummy cylinders to the right side of the cowling using R/C 56 glue. Paint the valve covers silver (Photo 93).



# WINDSHIELD INSTALLATION

- Cut the windshield along the molded cutting line using a pair of scissors (Photo 94).

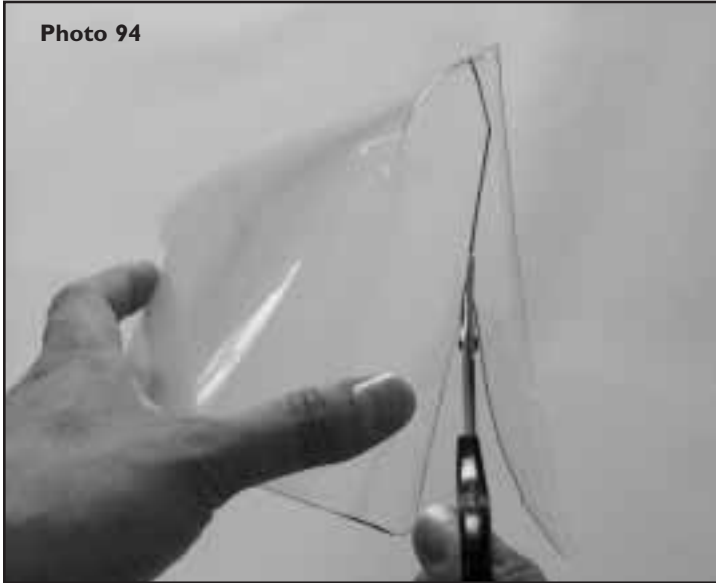

- Using black and yellow paint, paint the windshield as shown (Photo 95).

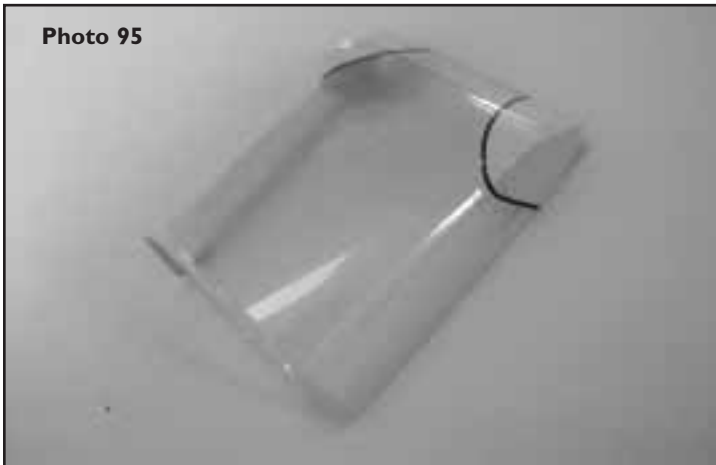

- Attach the windshield to the fuselage. Hold the windshield in place with masking tape. Apply R/C 56 glue along the area where the windshield meets the fuselage. Allow to cure over night (Photo 96).



# WING STRUT ATTACHMENT

- Cut a notch in the wing strut at each end. Drill a 5/64" (2mm) hole at the wing strut notch (Photo 97).



- Secure the mounting plate as shown with a M3x5 wood screw (Photo 98).



- Refer to Photo 99. The top strut is for the right wing and the lower strut is for the left wing.

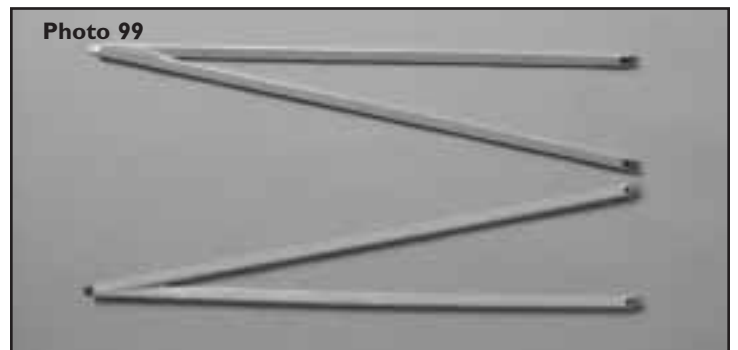

# WING STRUT ATTACHMENT

- Bend the mount plates that attach to the wing at a 25-degree angle so that they are flush with the surface of the wing (Photo 100).



- Place the strut on the wing locating the hardwood mounting blocks. Drill a 5/64" (2mm) hole at each mounting plate (Photo 101).



- Secure the wing strut with 2 M3x8 wood screws (Photo 102).



- Place the wing strut on the fuselage directly behind the landing gear fairing. Mark the position and drill a 5/64" (2mm) hole. Secure the strut using a M3x8 wood screw (Photo 103).



- Repeat the above sequence of steps for the other wing strut. Apply decals as desired to finish your model.

# BALANCE

Center of Gravity location should be between 4 and 4-1/2" back from the leading edge of the wing. Flying will determine the final balance point for your particular model.

# CONTROL THROWS

Make sure that all control surfaces move in the proper direction. Set the control surface throws as indicated for the initial flights. These may be altered later for personal preference.

Elevator:	Hi Rate:	1-1/4" up, 1-1/4" down
	Low Rate:	3/4" up, 3/4" down
Rudder:	Hi Rate:	Full deflection left and right not to interfere with elevators
	Low Rate:	1" left, 1" right
Aileron:	Hi Rate:	1" up, 3/4" down
	Low Rate:	3/4" up, 1/2" down

Prior to the first flight ensure that all batteries are properly charged, that controls all move in the proper direction, and that a thorough range check is made with and without the engine running.

# FLIGHT



The J-3 Cub is NOT a trainer. We assume you have mastered the basics of R/C flight. If not, we suggest you learn to fly with a trainer before attempting flight with the Cub. Thunder Tiger has a large selection of Trainers to choose from. Check with your hobby dealer for his recommendation.

Since your J-3 Cub is a faithful duplicate of its full scale counterpart, we highly recommend that you fly it just like the real thing. You will find yourself enjoying the airplane considerable more than if you simply bore holes in the sky. Energy management and minimum airframe stress should be utmost in your mind as you pilot the Cub. Put yourself in the cockpit and imagine yourself with your hands on the stick and your feet on the rudder pedals.

## TAKEOFF

You will find that your Cub is easy to taxi and the ground handling is predictable. If it doesn't track true, you may have to adjust the tail wheel by bending it a bit using two pairs of pliers.

Since the Cub is a high wing airplane, it is sensitive to crosswind ground loops. Be prepared with opposite aileron to counter-act crosswind taxiing.

For takeoff, point the plane directly into the wind and gradually advance throttle while neutralizing the elevator, letting the tail come up. Increase speed as much as possible before lifting off. Don't "horse" the plane off the ground. Remember, fly it like a real one! A gental climbout looks much more realistic than a 45 degree "aircraft carrier" takeoff.

## FLYING

Remember, fly your Cub like the real thing. Coordinate turns using rudder. Keep the maneuvers gentle, big, and graceful. Do your turnarounds with a gentle stall-turn. Remember, keep energy management and minimal airframe stress in mind at all time.

NEVER, NEVER do full throttle snap-rolls. Keep your Cub in one piece.

## LANDING

Since the Cub has a high lift and lightly loaded wing, it's a floater. There are times you will wish you had an anchor to throw out to get this plane down. Use the largest diameter, lowest pitch prop you can get as much prop disc drag as you can.

In wind, the safest way is to keep some power on and plant the main gear wheels in a two point landing; use the ground drag to slow the plane down and don't let the tail drop until you are below stall speed. Don't attempt a three pointer unless the wind is calm. Always be ready to advance the throttle and neutralize the elevator for a go-around.

To perfect your landings, practice is the best teacher. As a matter of fact, shooting touch and go's for a whole flight will give you as much fun as any other type flying with your Cub, plus you can fine-tune your landing skills.

## PRE-FLIGHT CHECK LIST

- 1. Check all control surfaces for possible looseness or deterioration.
- 2. Check all screws, clevises, nuts and all other connectors to make sure they are securely fastened.
- 3. Check which radio frequencies are being used. Do not turn on your radio until absolutely sure you are the only one operating on that frequency.
- 4. Check for proper operation of all control surfaces.
- 5. Check the level of charge in both the transmitter and receiver batteries before flying.
- 6. Range check the radio both with and without the engine running! Follow the radio manufacturers instructions for this.

## POST-FLIGHT CHECK LIST

- 1. Be sure that both the transmitter and receiver switches are turned off.
- 2. Drain all excess fuel from the tank. Fuel left in the tank for extended periods can "gunk up" the tank, fittings and carburetor.
- 3. Clean the plane with paper towels and a light-duty spray cleanser. Keeping your plane clean will make it last longer and keep it looking nice.
- 4. Put a few drops of after-run or light oil in the carburetor and turn the prop over a few times (without the glow plug ignited) to distribute the oil throughout the engine.
- 5. Inspect the prop and replace it if any chips or cracks are found.
- 6. Inspect the entire plane for covering tears, new dings and dents, loose screws and connectors and any other wear and tear.

## SAFETY PRECAUTIONS

- 1. Wear safety glasses when starting and running all model engines.
- 2. Model engine fuel is very flammable and the flame is very dangerous because it is almost invisible! Do not smoke or allow sparks, high heat or other flames near the fuel.
- 3. Do not run model engines inside a garage or other closed room as they give off large amounts of deadly carbon monoxide gas.
- 4. Do not run model engines around gravel, sand or other loose debris. These materials will be ingested through the carburetor and can also be kicked up by the prop.
- 5. Always stay behind the propeller when the engine is running. Make all engine adjustments from behind the engine.
- 6. Do not allow loose clothing or other loose objects close to the prop.
- 7. To stop an engine, cut off the fuel or air supply to the engine. Do not throw rags or other objects into the prop to stop the engine.
- 8. Do not touch the engine or muffler during or right after it has been running—it gets very hot!

## CHOOSE THESE OTHER FINE PRODUCTS:



### TTR2702 Thunder Tiger Power Monitor

The perfect device to distribute the power of a 12V field box battery: metered hi efficiency glow driver, fuel pump, and starter.

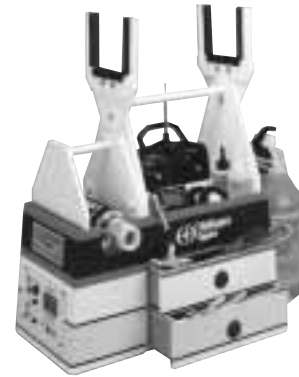

### TTR3302 Thunder Tiger Tiger Tote™

Keep all your stuff organized with a Tiger Tote, with a pre-cut power panel slot and available with or without Remote Starting System.



### TTR1658 Thunder Tiger Fuel Pump

Our most popular fuel pump; fuel and defuel from a 12V source; fuel filter and fuel line included.

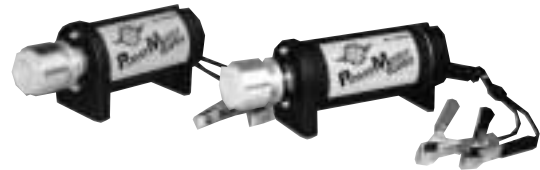

### ACE24020-24030 Ace PowerMaster Starters

Keep all those fingers on your hands with budget-priced Ace R/C starters, available in two sizes, starting engines from 1/2A to 1.20.



### TTR1102 Thunder Tiger 4-Way Wrench

Thunder Tiger's lightweight 4-way wrench fits all glow plugs and prop nuts, plus has room to store extras.



### Ace Electronics

Choose from any of Ace's battery maintenance electronics including our world-famous Digipace 3 to the revolutionary Smart Charge. Time proven usefulness for any R/Cer.

## THE PERFECT ENGINE FOR YOUR J-3 Cub!



### TTR9800 Thunder Tiger F-54S

The F-54S is the perfect engine for your Cub, with plenty of power and a great, realistic sound.

# Fun Tigers

## FUN TIGER G-200

Fun Tiger G-200

*Designed by Fred Reese*

### Fun Tigers

Now you can experience the breathtaking, adrenaline-pumping thrills of this HOT category of R/C planes without having to invest any building time. Do some simple assembly, strap on a high-performance .40 engine, such as our PRO-46, install your radio system, and you are ready to join in the fun.

These outrageously maneuverable 3-D Fun Fly planes will do just about anything imaginable, especially because of Thunder Tiger's super lightweight construction. Be a "hot dog". Go vertical from dead stop on the runway in about a fuselage-length of roll-out; do knife-edge loops, rolling circles, hovering flight, snaps, spins, and anything your blood pressure will allow.

Choose either the Fun Tiger Extra or the Fun Tiger Giles-200, replicas of two of the latest full-scale aerobatic airplanes. If you want to dress one up in your favorite color scheme, choose our Almost-Ready-To-Cover version.

- TTR4517 Fun Tiger G-200
- TTR4518 Fun Tiger Extra
- TTR4522 Fun Tiger ARC



**ARF**  
Almost Ready to Fly



F-54

#### Recommended Engines:



PRO-46



Fun Tiger ARC

**ARC**  
Almost Ready to Cover

## FUN TIGER EXTRA



Fun Tiger Extra

**ARF**  
Almost Ready to Fly

Fun Tigers	
Wing Span:	47" (1194mm)
Wing Area:	696 in <sup>2</sup> (44.9dm <sup>2</sup> )
Length:	43" (1092mm)
Weight:	4 lbs. (1.8kg)
Engine:	.40-.50 2-stroke .40-.65 4-stroke
Radio:	4 Channel