

# Byp Yak

Assembly Manual



**E-flite**<sup>TM</sup>



## Table of Contents

---

|  |    |
|--|----|
| Introduction .....   | 2  |
| Specifications .....   | 3  |
| Contents of Kit/Parts Layout .....                             | 3  |
| Quique Somenzini's Competition Radio Equipment .....           | 4  |
| Alternative Radio Equipment .....                              | 4  |
| Important Information About Motor Selection .....              | 5  |
| Quique Somenzini's Competition Outrunner Setup .....           | 5  |
| Required Tools and Adhesives .....                             | 5  |
| Optional Accessories .....                                     | 5  |
| Using the Manual .....   | 6  |
| Warning .....  | 6  |
| Before Starting Assembly .....                                 | 6  |
| Note on Lithium Polymer Batteries .....                        | 6  |
| Limited Warranty Period .....                                  | 6  |
| Wing Installation .....  | 10 |
| Stabilizer and Rudder Installation .....                       | 18 |
| Motor and Speed Control Installation .....                     | 22 |
| Radio Installation .....                                       | 24 |
| Landing Gear Installation .....                                | 32 |
| Center of Gravity / Battery Installation .....                 | 34 |
| Control Throws .....   | 36 |
| Quique Somenzini's Competition Radio Setup .....               | 36 |
| 2006 Official AMA<br>National Model Aircraft Safety Code ..... | 38 |

## Introduction

---

Thank you for purchasing the Quique Somenzini designed Byp Yak ARF Competition Indoor 3D/Precision Aerobatic model, which is based on his popular gas-powered competitive Yak aerobatic airplanes. Quique designed this model to compete at top-level events such as the E-TOC and for nationwide demos. Quique uses his own unique A-frame design on the fuselage shape, which reduces flex in the more rigid fuselage giving you more precision control.

From super slow to top airspeed, flying the Byp Yak features a great combination of smoothness and precision, helping make this foam Byp Yak an extreme 3D flying performer like no other foam airplanes of this caliber. The Byp Yak is capable of doing all the maneuvers that you have ever dreamt of and more.

### ***New Foam***

E-flite™ is introducing a new flat foam material with this aircraft. It is much more durable than other flat foams used in the past. We believe this will bring a higher level of success and enjoyment to your Byp Yak experience.

## Specifications

|                     |                          |
|---------------------|--------------------------|
| Wingspan:           | 32 in (815mm)            |
| Length:             | 31.25 in (795mm)         |
| Wing Area:          | 490 sq in (32 sq dm)     |
| Weight w/o Battery: | 9.5–10 oz (270–285 g)    |
| Weight w/Battery:   | 10.5–11.5 oz (300–325 g) |

## Contents of Kit/Parts Layout

### Large Replacement Parts:

|         |                                 |
|---------|---------------------------------|
| EFL2326 | Wing Set w/Struts               |
| EFL2327 | Fuselage                        |
| EFL2328 | Tail Assembly                   |
| EFL2331 | Wheel Pants/Landing Gear Covers |
| EFL2134 | Landing Gear                    |

### Small Replacement Parts:

|         |                                   |
|---------|-----------------------------------|
| EFL2329 | Carbon Fiber Supports             |
| EFL2330 | Aileron Rods                      |
| EFL2086 | Hook & Loop Tape, 1" x 1.375" (2) |
| EFLA200 | Micro Control Horns               |
| EFLA202 | Micro Tail Skid                   |
| EFLA203 | Micro Control Connectors          |
| EFLA213 | E-flite/JR/Horizon Decals         |
| EFLA214 | Micro Pull-Pull Set               |
| EFLA220 | Foam Park Wheels, 1.25"           |



## Quique Somenzini's Competition Radio Equipment

---

Listed below is the exact radio equipment that Quique Somenzini uses when flying the Byp Yak in competitions. In the back of the manual, we also provide you with his exact radio setup, listing his dual rates, exponential, and mixing programs.

### **Transmitter**

|         |   |
|---------|---|
| JR 9303 | XP9303 9-Channel, 30-Model Memory Transmitter |
|---------|---|

### **Purchase Separately**

|          |  |
|----------|--|
| JSP30610 | 6-Channel UltraLite Rx w/o Crystal, Positive Shift JR/Air (72 MHz) |
| JRPXFR** | FM Receiver Crystal  |
| JRPS281  | DS281 Sub-Micro Digital (3)  |

## Alternative Radio Equipment

---

You will need a minimum 6-channel transmitter (for proper mixing and dual rate capabilities), crystals, micro receiver, and three sub-micro servos. You can choose to purchase a complete radio system that includes all of these items or, if you are using an existing transmitter, just purchase the other required equipment separately.

We recommend the crystal-free, interference-free Spektrum™ DX6 2.4GHz DSM™ 6-channel system, which includes a micro receiver and 4 sub-micro servos.

### **Complete Radio System**

|         |                                |
|---------|--------------------------------|
| SPM2460 | DX6 DSM 6CH Park Flyer w/4-S75 |
|---------|--------------------------------|

### **Or Purchase Separately**

|          |  |
|----------|--|
| JSP30610 | 6-Channel UltraLite Rx w/o Crystal, Positive Shift JR/AIR (72MHz)  |
| JSP30615 | 6-Channel UltraLite Rx w/o Crystal, Negative Shift Fut/HRC (72MHz) |
| JRPXFR** | FM Receiver Crystal (JR only, not AR6000)                          |

### **Or**

|         |                                    |
|---------|------------------------------------|
| SPM6000 | AR6000 DSM 6CH Park Flyer Receiver |
|---------|------------------------------------|

### **And**

|         |  |
|---------|--|
| EFLRS75 | 7.5 Gram Sub-Micro Servo (3)                         |
| JRPA092 | Servo Extension, 3" Standard (may be needed for ESC) |

## Important Information About Motor Selection

---

We recommend you use the E-flite™ brushless outrunner motor Quique Somenzini uses on his Byp Yak. All of our flight tests were done using the motor listed below with the Li-Po battery listed below. Another alternative battery is to use the Thunder Power 730mAh 3-Cell 11.1V Li-Po Battery (THP7303SJPL) for extended flight time.

### Quique Somenzini's Competition Outrunner Setup

---

|            |  |
|------------|--|
| EFLM1200   | Park 370 Brushless Outrunner Motor, 1080Kv |
| CSEPHX10L  | 10-Amp Brushless ESC                       |
| APC10038SF | 10x3.8 Slow Flyer Prop                     |
| EFLC3005   | Celectra™ 1-3 Cell Li-Po Charger           |

#### **Recommended Battery (by E-Flite)**

THP4803SJPL 480mAh 3-Cell 11.1V Li-Po, JST

This setup is very light for slow precise indoor flying.

## Required Tools and Adhesives

---

### *Tools & Equipment*

|                     |   |
|---------------------|---|
| EFLA257             | Screwdriver, #0 Phillips (or included with EFLA250) |
| EFLA251             | Hex Wrench: 3/32" (or included with EFLA250)        |
| Hobby knife         |   |
| Square              |   |
| Ruler               |   |
| Felt-tipped pen     |   |
| String              |   |
| Paper Towels/Tissue |   |
| T-Pins              |   |
| Pliers              |   |
| Low-Tack tape       |   |

### *Adhesives*

|         |                                |
|---------|--------------------------------|
| EFLA208 | Foam CA 1oz/Activator 2oz Pack |
| EFLA209 | Foam Compatible Medium CA, 1oz |

### **Optional Accessories**

---

|             |   |
|-------------|---|
| EFLA110     | Power Meter   |
| THP7303SJPL | 730mAh 3-Cell 11.1V Li-Po Battery (for longer flight times) |

## Using the Manual

---

This manual is divided into sections to help make assembly easier to understand, and to provide breaks between each major section.

Remember to take your time and follow the directions.

## Warning

---

An RC aircraft is not a toy! If misused, it can cause serious bodily harm and damage to property. Fly only in open areas, preferably at AMA (Academy of Model Aeronautics) approved flying sites, following all instructions included with your radio.

Keep loose items that can get entangled in the propeller away from the prop, including loose clothing, or other objects such as pencils and screwdrivers. Especially keep your hands away from the propeller.

## Before Starting Assembly

---

Before beginning the assembly of your Byp Yak, remove each part from its bag for inspection. Closely inspect the fuselage, wing panels, rudder and stabilizer for damage. If you find any damaged or missing parts, contact the place of purchase.

## Note on Lithium Polymer Batteries

---



Lithium Polymer batteries are significantly more volatile than alkaline or Ni-Cd/Ni-MH batteries used in RC applications. All manufacturer's instructions and warnings must be followed closely. Mishandling of Li-Po batteries can result in fire. Always follow the manufacturer's instructions when disposing of Lithium Polymer batteries.

## Limited Warranty Period

---

Horizon Hobby, Inc. guarantees this product to be free from defects in both material and workmanship at the date of purchase.

## **Limited Warranty & Limits of Liability**

Pursuant to this Limited Warranty, Horizon Hobby, Inc. will, at its option, (i) repair or (ii) replace, any product determined by Horizon Hobby, Inc. to be defective. In the event of a defect, these are your exclusive remedies.

This warranty does not cover cosmetic damage or damage due to acts of God, accident, misuse, abuse, negligence, commercial use, or modification of or to any part of the product. This warranty does not cover damage due to improper installation, operation, maintenance, or attempted repair by anyone other than an authorized Horizon Hobby, Inc. service center. This warranty is limited to the original purchaser and is not transferable. In no case shall Horizon Hobby's liability exceed the original cost of the purchased product and will not cover consequential, incidental or collateral damage. Horizon Hobby, Inc. reserves the right to inspect any and all equipment involved in a warranty claim. Repair or replacement decisions are at the sole discretion of Horizon Hobby, Inc. Further, Horizon Hobby reserves the right to change or modify this warranty without notice.

REPAIR OR REPLACEMENT AS PROVIDED UNDER THIS WARRANTY IS THE EXCLUSIVE REMEDY OF THE CONSUMER. HORIZON HOBBY, INC. SHALL NOT BE LIABLE FOR ANY INCIDENTAL OR CONSEQUENTIAL DAMAGES.

As Horizon Hobby, Inc. has no control over use, setup, final assembly, modification or misuse, no liability shall be assumed nor accepted for any resulting damage or injury. By the act of use, setup or assembly, the user accepts all resulting liability.

If you as the purchaser or user are not prepared to accept the liability associated with the use of this product, you are advised to return this product immediately in new and unused condition to the place of purchase.

## **Safety Precautions**

This is a sophisticated hobby product and not a toy. It must be operated with caution and common sense and requires some basic mechanical ability. Failure to operate this product in a safe and responsible manner could result in injury or damage to the product or other property. This product is not intended for use by children without direct adult supervision.

The product manual contains instructions for safety, operation and maintenance. It is essential to read and follow all the instructions and warnings in the manual, prior to assembly, setup or use, in order to operate correctly and avoid damage or injury.

## **Questions, Assistance, and Repairs**

---

Your local hobby store and/or place of purchase cannot provide warranty support or repair. Once assembly, setup or use of the product has been started, you must contact Horizon Hobby, Inc. directly. This will enable Horizon to better answer your questions and service you in the event that you may need any assistance.

### **Questions or Assistance**

---

For questions or assistance, please direct your email to [productsupport@horizonhobby.com](mailto:productsupport@horizonhobby.com), or call 877.504.0233 toll free to speak to a service technician.

## **Inspection or Repairs**

---

If your product needs to be inspected or repaired, please call for a Return Merchandise Authorization (RMA). Pack the product securely using a shipping carton. Please note that original boxes may be included, but are not designed to withstand the rigors of shipping without additional protection. Ship via a carrier that provides tracking and insurance for lost or damaged parcels, as Horizon Hobby, Inc. is not responsible for merchandise until it arrives and is accepted at our facility. Include your complete name, address, phone number where you can be reached during business days, RMA number, and a brief summary of the problem. Be sure your name, address, and RMA number are clearly written on the shipping carton.

### **Warranty Inspection and Repairs**

---

To receive warranty service, you must include your original sales receipt verifying the proof-of-purchase date. Providing warranty conditions have been met, your product will be repaired or replaced free of charge. Repair or replacement decisions are at the sole discretion of Horizon Hobby.



## **Non-Warranty Repairs**

---

Should your repair not be covered by warranty and the expense exceeds 50% of the retail purchase cost, you will be provided with an estimate advising you of your options. You will be billed for any return freight for non-warranty repairs. Please advise us of your preferred method of payment. Horizon Hobby accepts money orders and cashiers checks, as well as Visa, MasterCard, American Express, and Discover cards. If you choose to pay by credit card, please include your credit card number and expiration date. Any repair left unpaid or unclaimed after 90 days will be considered abandoned and will be disposed of accordingly.

Electronics and engines requiring inspection or repair should be shipped to the following address (freight prepaid):

Horizon Service Center  
4105 Fieldstone Road  
Champaign, Illinois 61822

All other products requiring inspection or repair should be shipped to the following address (freight prepaid):

Horizon Product Support  
4105 Fieldstone Road  
Champaign, Illinois 61822

## Wing Installation

### Required Parts

- Fuselage
- Lower wing
- Strut reinforcement disk (14)
- .045" x 6" (1.15mm x 153mm) carbon rod (6)
- .045" x 13" (1.15mm x 330mm) carbon rod (2)
- .045" x 12<sup>5</sup>/<sub>8</sub>" (1.15mm x 320mm) carbon rod (2)
- Wing strut (2)
- Upper wing

### Required Tools and Adhesives

- Foam-safe CA
- Hobby knife
- Square

- 1. Place the fuselage on a flat surface. Use a square at the rudder to check that the fuse bottom and fin are square to each other. Lightly sand the bottom of the fuse where indicated if necessary.

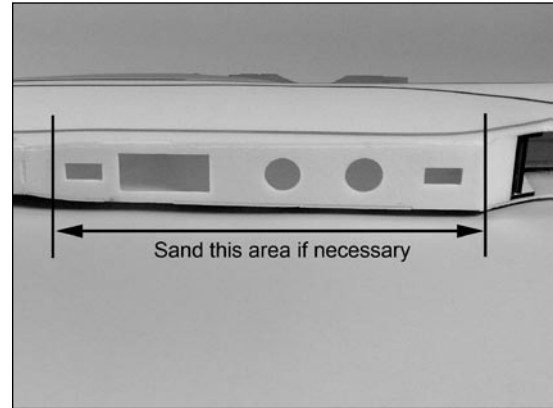

- 2. Test fit the lower wing to the fuselage. Place the wing onto the fuse bottom, aligning the servo holes in the wing with the servo holes in the fuselage. Carefully check to make sure the lower wing is square to the fuselage by measuring from the wing tip to the fin on both sides. Use foam-safe CA to glue the lower wing to the fuselage.

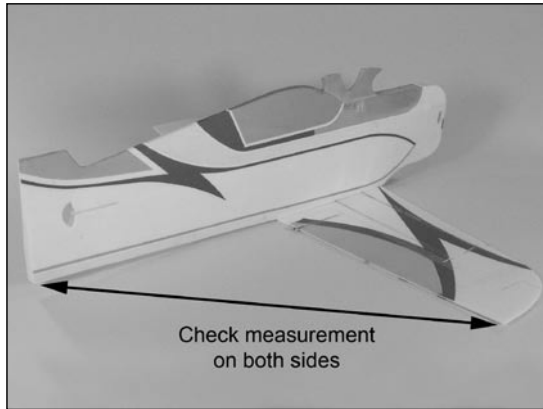

**Note:** You can use foam-safe activator to speed up the CA cure time.

- 3. Locate the wing struts. Use a sharp hobby knife to remove the lower sections from the main section.

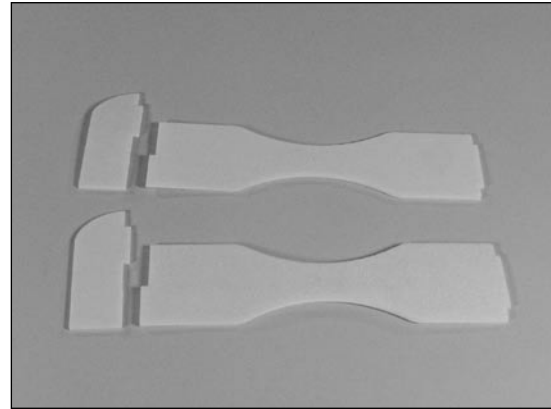

- 4. Position the wing strut in the hole closest to the aileron of the bottom wing. It may be necessary to trim the reinforcement tape from the hole before fitting the strut. Use a square and foam-safe CA to glue both the wing struts into position.

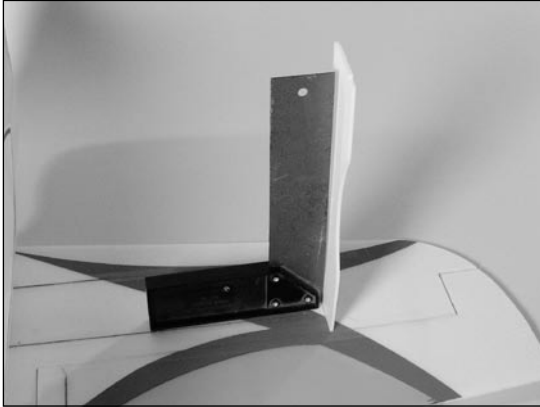

- 5. Place the top wing onto a flat surface. Position the wing struts and fuselage onto the wing. Hold the wing flat while gluing the fuselage and side force generators to the wing.

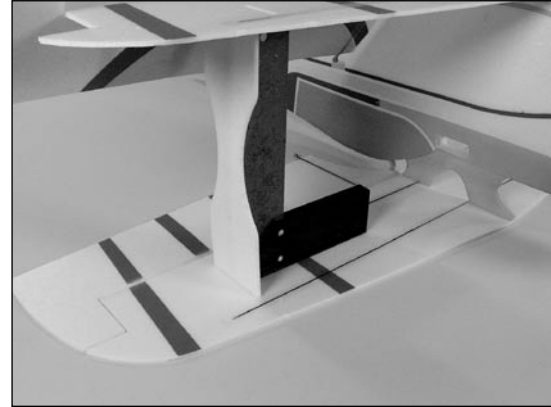

**Note:** It is recommended to use a square to check the wing strut alignment to the top wing.

**Note:** DO NOT glue the lower strut extension at this time.

**Note:** You may want to locate a thin piece of Depron or other foam for the next section. A thin board will work too. This is necessary to keep the wing as flat as possible to keep from inducing any twist in the wing, which will greatly affect the performance of your Byp Yak.

- 6. Glue the strut reinforcement disks to the bottom of the top and bottom wings. The positions have been marked at the factory. The slots in the disks will run parallel to the spars.

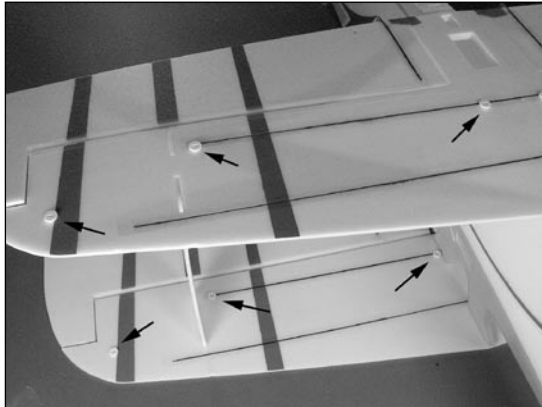

- 7. Once the CA has fully cured from Step 6, slide a hobby knife into each of the reinforcements to make a thin slot. Do not cut an official slot; just slip the knife in and out.

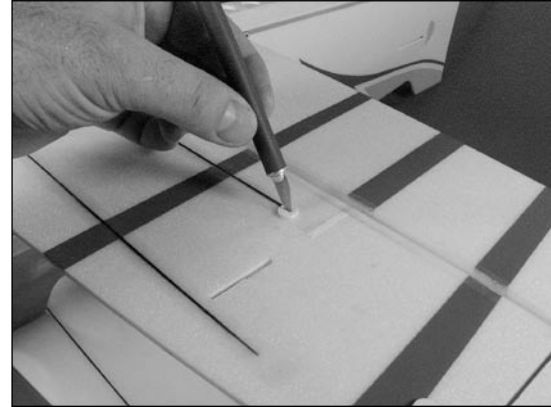

- ○ 8. Slide a  $.045" \times 12^{5/8}"$  (1.15mm x 320mm) carbon rod from the center of the bottom wing to the top wing near the strut. Leave at least  $1/16"$  (1.5mm) of the rod exposed at both ends. Glue the rod only at the fuselage. Apply foam-safe CA to the rod both at the inside and outside in order to capture the rod in position.

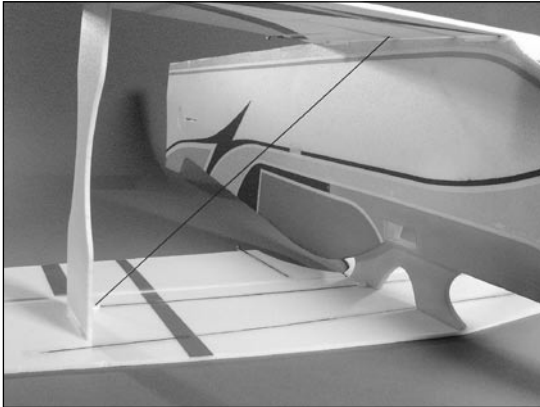

- ○ 9. Place the top wing on a surface that will allow the wing panel to lie perfectly flat. Apply glue to the inside edge of the rod. Once the glue fully cures, carefully lift the airframe and apply CA to the top of the rod.
- 10. Repeat Steps 8 and 9 for the opposite side.

- ○ 11. Slide a .045" x 13" (1.15mm x 330mm) carbon rod near the wing strut on the bottom wing to the center of the top wing near the fuselage. Leave at least 1/16" (1.5mm) of the rod exposed at both ends. Glue the rod only at the bottom wing. Apply foam-safe CA to the rod both at the inside and outside in order to capture the rod in position.

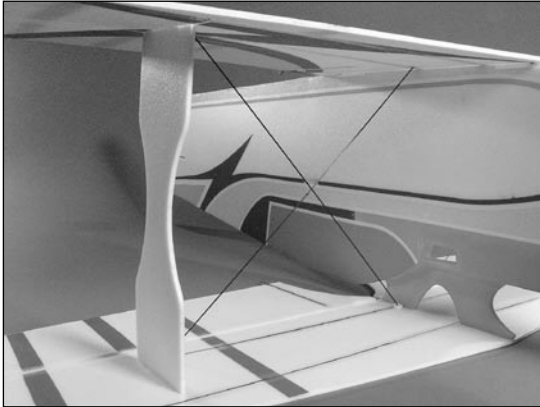

- ○ 12. Place the bottom wing on a surface that will allow the wing panel to lie perfectly flat. Apply glue to the inside edge of the rod. Once the glue fully cures, carefully lift the airframe and apply CA to the top of the rod.
- 13. Repeat Steps 11 and 12 to complete the cross bracing.

- ○ 14. Attach the remaining two strut reinforcement disks to the inside of the struts. Once the CA cures, slide one of the .045" x 6" (1.15mm x 153mm) carbon rods from the center of the cross brace through the reinforcement. Carefully wrap the intersection using string. Soak the thread at the intersection with thin CA to secure the joint.



**Note:** Do not glue the carbon rod at the strut at this time.

- ○ 15. Position two .045" x 6" (1.15mm x 153mm) carbon rods from the tips of the top and bottom wing to the center of the strut. Leave at least 1/16" (1.5mm) of the rod exposed on both ends. Apply CA to only the struts at the wing tips.

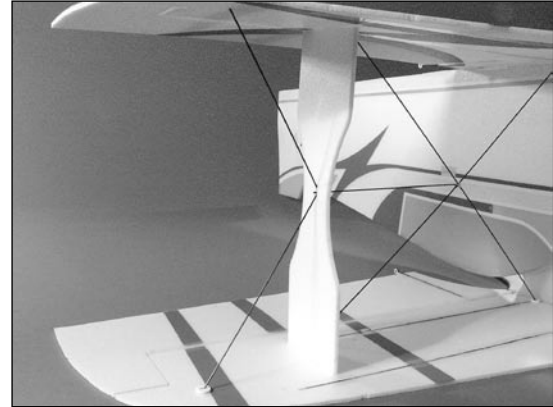



- ○ 16. Use a straight edge to make sure the wing strut is not bent in or out on the wing. Glue both sides of the rod to the wing strut.

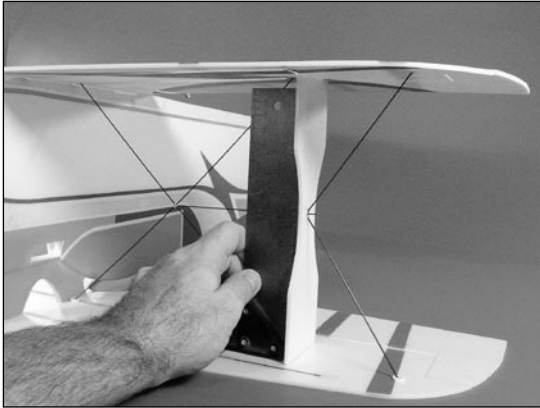

- 17. Repeat Steps 14 through 16 to complete the wing installation.

## Stabilizer and Rudder Installation

### Required Parts

- Fuselage
- Right elevator
- Rudder
- Hinge tape
- Stabilizer w/left elevator
- Carbon elevator joiner (2)
- Control horn (2)

### Required Tools and Adhesives

- Foam-safe CA
- Paper towel/tissue
- T-pins
- Ruler
- String
- Foam-safe activator

- 1. Use foam-safe CA to glue the plywood elevator horn into position.

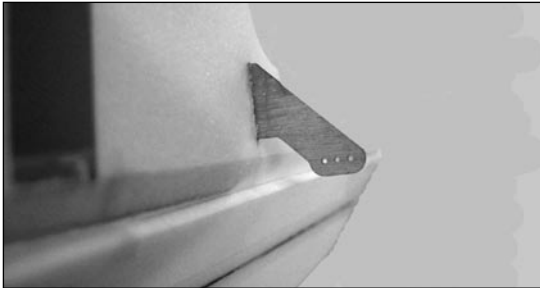

**Note:** Ensure that the holes in the control horn are in line with the hinge line.

- 2. Slide the stabilizer into position, centering it in the slot. Sight from the rear of the fuselage and check that the stabilizer is parallel to the wings. If not, lightly sand the opening in the fuselage.

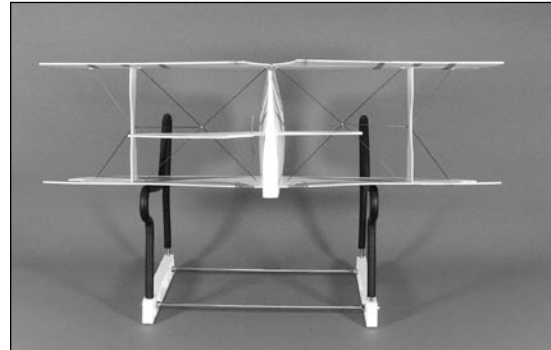

- 3. Hinge the elevator using the supplied tape. Apply tape to the hinge line on the top, and then deflect the elevator up to apply the tape on the bottom.

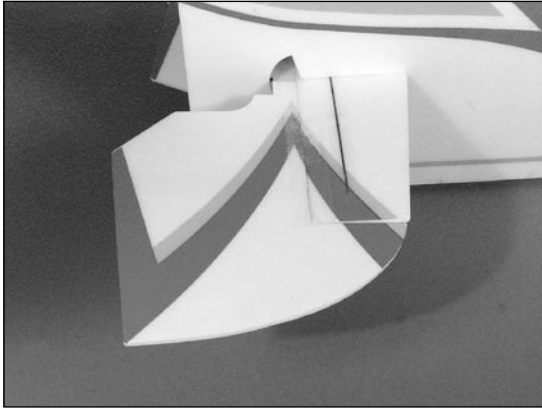

- 4. Use foam-safe CA to glue the carbon elevator joiner to the top and bottom of the elevators.

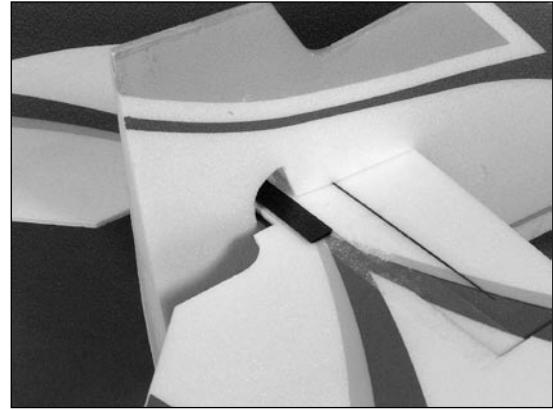

**Note:** Make sure you are gluing the joiner directly onto the foam and not onto the hinge tape.

- 5. Check the alignment of the stabilizer to the front of the fuselage. The distances between a point centered on the fuselage to either stabilizer tip should be the same.

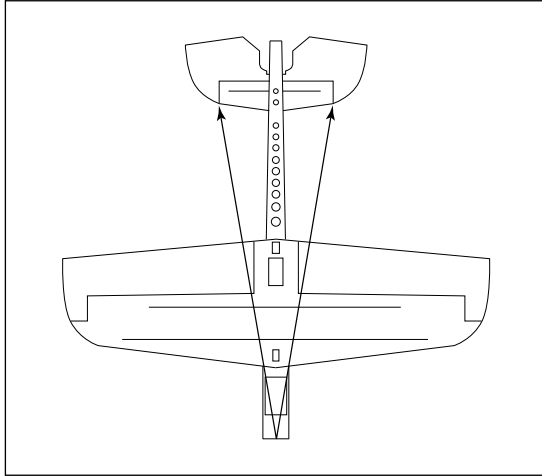

- 6. Once satisfied with the stabilizer alignment, use foam-safe CA to glue the stabilizer to the fuselage. Clean up excess glue with a tissue or paper towel.

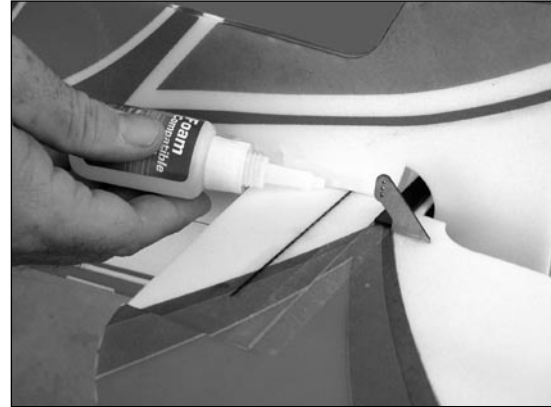

**Note:** You can use foam-safe Activator to speed up this CA cure time.

- 7. Use foam-safe CA to glue the plywood rudder horn into position

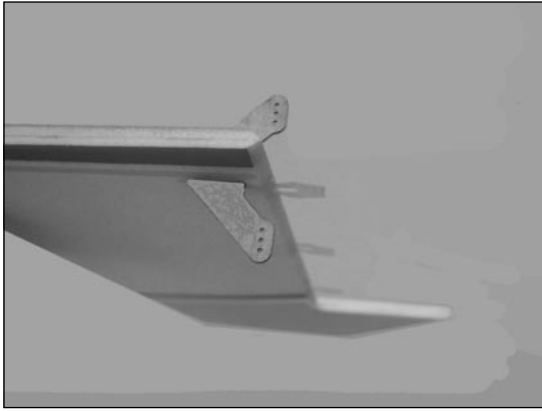

**Note:** Ensure that the holes in the control horn are in line with the hinge line.

**Note:** Do not use CA on the hinges until you are sure the fit of the rudder is correct.

- 8. Test fit the rudder to the fuselage. Check that when the hinge line of the rudder is against the fuselage, the balance tab does not interfere with the fin.

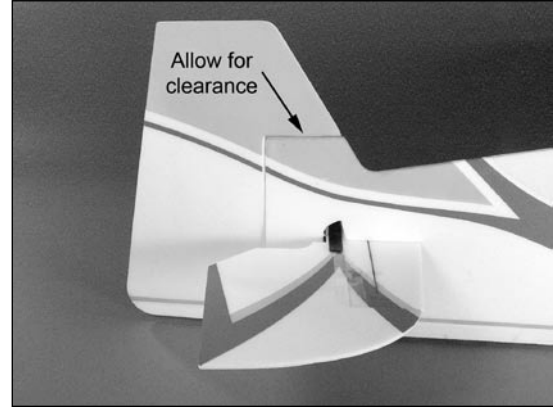

- 9. Once satisfied with the fit, apply 2–3 drops of foam-safe CA to each side of each rudder hinge. Work quickly to install the rudder before the CA has time to cure.

## Motor and Speed Control Installation

### Required Parts

- Airframe
- Receiver
- 3mm x 5mm screw (4)
- 3mm washer (2)
- Prop adapter
- Hook and loop material
- 10-amp electronic speed control
- Propeller (10 x 3.8 recommended)
- Brushless outrunner motor (EFLM1200 recommended)

### Required Tools and Adhesives

- Foam-safe CA
- Phillips screwdriver (small)
- Hex wrench, 3/32"

**Note:** It is very important to check to be sure the propeller is balanced before installing onto the shaft.

- 1. To use an E-flite™ Outrunner, the shaft of the motor must exit the fixed part of the motor instead of through the rotating portion. You will have to change this. Loosen the setscrew in the rotating part of the motor. Slide the shaft through the motor and tighten the setscrew.



**Note:** Please follow the instructions included with your E-flite Outrunner motor for repositioning of the propeller shaft.

- 2. Attach the ESC to the motor. It may be necessary to solder connectors on the ESC.

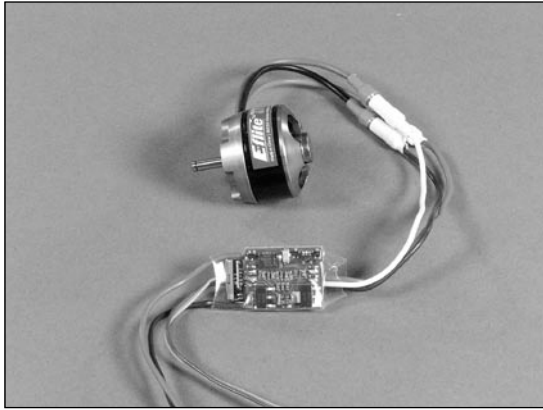

- 3. Check the direction of rotation of the motor using the radio system and motor. It should rotate counter-clockwise when viewed directly from the front. If it rotates clockwise, follow the instructions included with the ESC to correct the problem.

- 4. Mount the motor, using four 3mm x 8mm screws and two 3mm washers. 3mm washers must be installed between the firewall and the motor on the pilot's right side to provide the correct amount of right thrust.

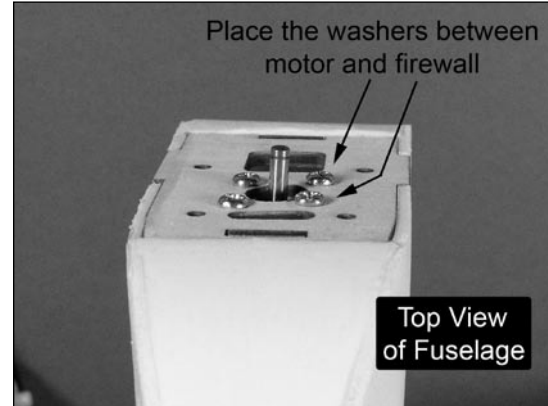

**Note:** Please be sure to use an ESC with the proper 9V cutoff when using 3-cell Li-Po packs. We also suggest this cutoff to be of the soft variety to prevent hard motor cutoffs during low level 3D flying.

- 5. Attach the propeller using the propeller adapter included with the motor.

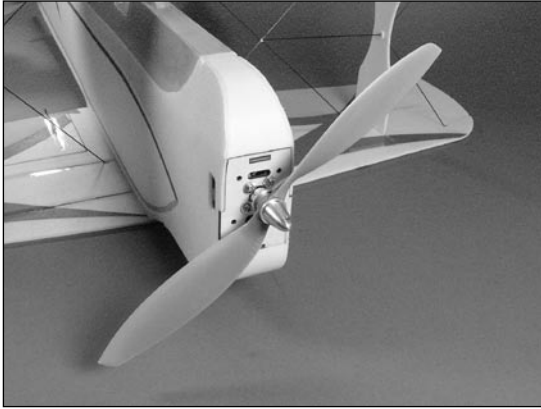

- 6. Secure the speed control location using double-sided tape or hook and loop. Exact speed control location may vary, depending on the brand used and the center of gravity.

## Radio Installation

---

### **Required Parts**

- Airframe
- Servo (3)
- Control cable
- Micro control horn w/backplate (2)
- Servo extension, 3" (76mm)
- Micro cable adjust connector (4)
- Aileron linkage, 5<sup>3</sup>/<sub>4</sub>" (146mm) (2)
- Aileron interconnect linkage, 9<sup>1</sup>/<sub>4</sub>" (235mm) (2)
- Micro control connector w/nylon backplate and 2mm x 3mm screw (8)
- Cable crimp (8)
- Long servo arm (3)
- Hook and loop material

### **Required Tools and Adhesives**

- Foam-safe CA
- Hot glue
- Phillips screwdriver (small)
- Pliers (for crimping)
- Low-tack tape



- 1. Use hot glue to install the rudder, elevator and aileron servos.

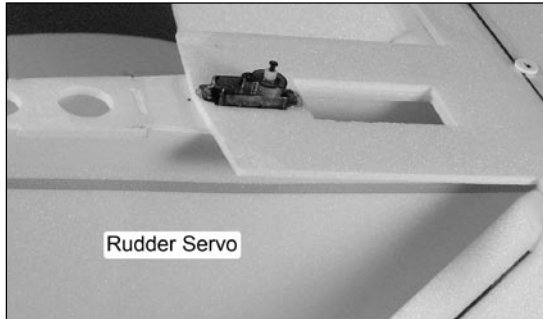

- 2. Plug the elevator, rudder, aileron and ESC into the receiver and check their operation. Use hook and loop to attach the receiver to the inside of the fuselage. Use a short 3" (76mm) extension for the speed control if needed.

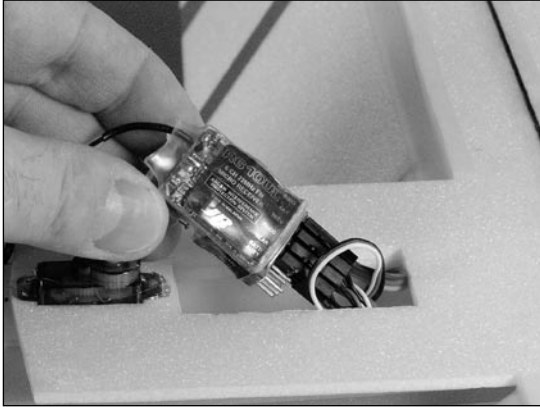

- 3. Route the antenna to the tail and then back up the opposite side of the fuselage. Do not cut the antenna as this will reduce the range of your radio system.
- 4. Install the six micro control connectors into each of the three long servo arms. Secure them using the control connector back plates.



- 5. With the radio system on, install the servo arms on the servos.

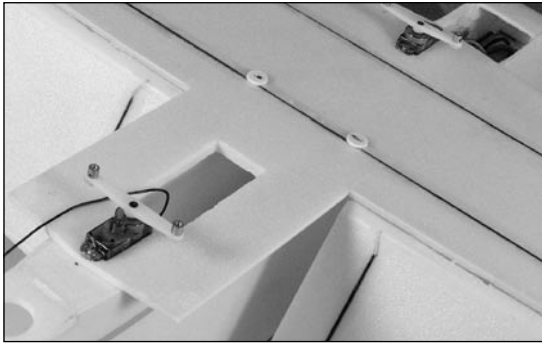

**Note:** If you use the ESC to power your radio, be absolutely sure to remove the propeller to avoid injury.

**Note:** Turn on radio system and verify all subtrims and flight trims are at zero or centered.

- 6. Locate the control cable and cut it into four equal sections.

- ○ 7. Use tape to hold the rudder in neutral. Slide a cable crimp onto the control cable. The cable then goes through the horn, and back through the crimp. Use pliers to secure the crimp.

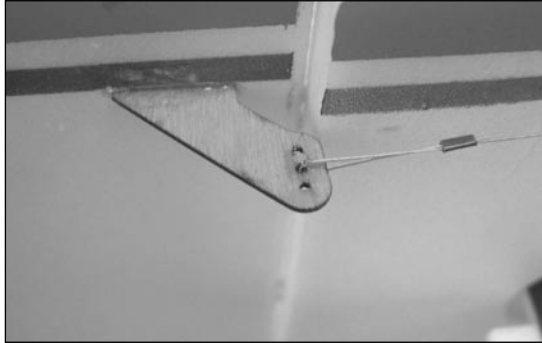

**Note:** We recommend connecting the cable to the middle hole for the rudder control linkage setup.

- ○ 8. Slide the micro cable adjust connector into the micro control connector and use a 2mm x 3mm screw to hold it in position. Repeat Step 7, installing the cable through the cable connector.

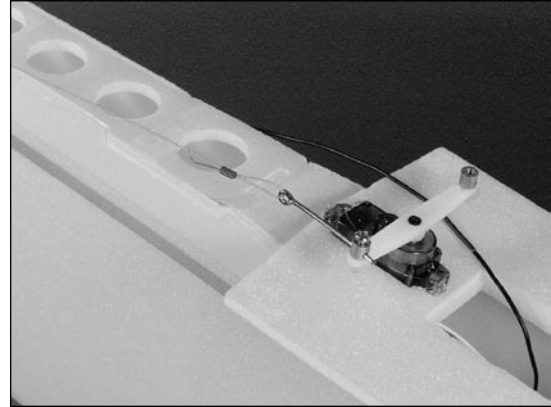

- ○ 9. Remove the tape from the control surface. Install the second cable following Steps 7 and 8. Tension the cables lightly using the cable connectors to pull the surface into neutral.

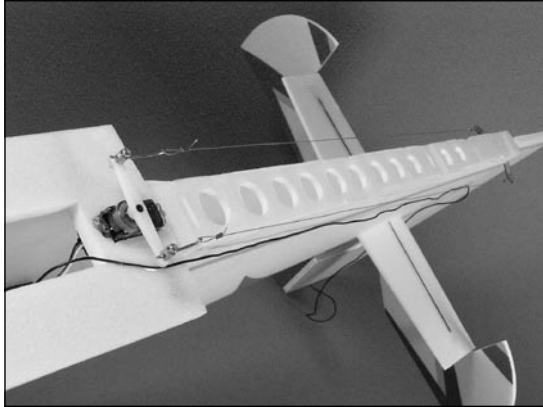

- 10. Repeat Steps 7 through 9 for the elevator cables.



**Note:** We recommend connecting the cable to the inner hole for the elevator control linkage setup.

- 11. Attach the micro control horn to the ailerons using the micro control horn back plates and foam-safe CA.

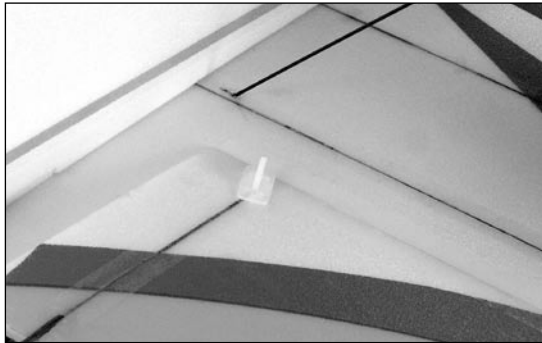
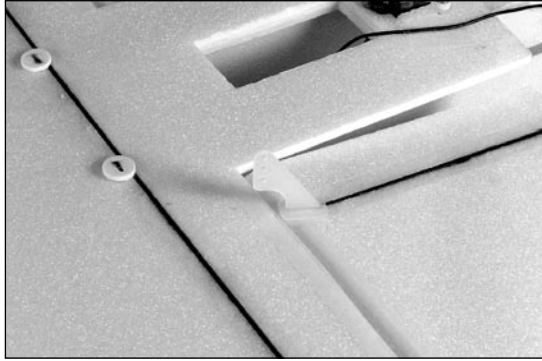

- 12. Pass the "Z" bend of the  $5\frac{3}{4}$ " (146mm) aileron linkages through the control horns. The opposite end goes through the micro control connector. With everything centered, secure the linkages using the 2mm x 3mm screws.

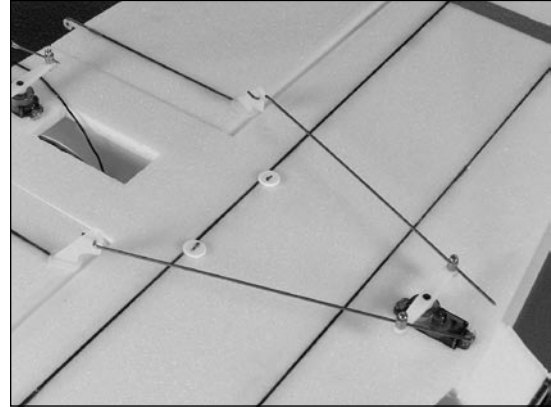

- ○ 13. Attach a micro control connector to the horn on the top aileron. Make sure the hole for the screw faces towards the wing tip.

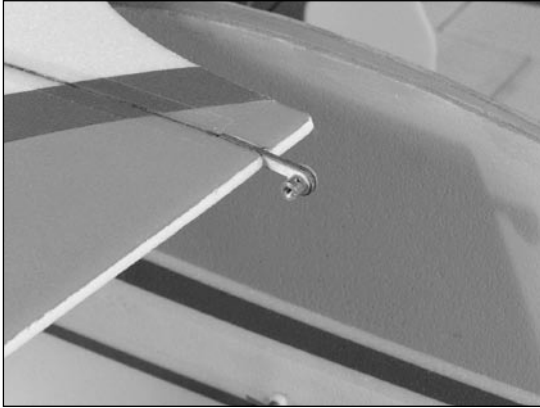

- ○ 14. Pass the "Z" bend of a 9 1/4" (235mm) aileron interconnect linkage into the horn on the bottom aileron. Slide the linkage through the micro control connector, center the ailerons, and tighten the 2mm x 3mm screw.



**Hint:** Lay a ruler from the leading edge to the trailing edge to check that the upper aileron is in neutral.

- ○ 15. Repeat Steps 13 and 14 for the remaining aileron.

## Landing Gear Installation

### Required Parts

- Airframe
- Tail skid
- Wheel retainer (2)
- Landing gear fairing (2)
- Landing gear
- Wheel pant (2)
- 1 1/4" (32mm) wheel (2)

### Required Tools and Adhesives

- Hot glue
- Foam-safe CA

- 1. Glue the tail skid using foam-safe CA

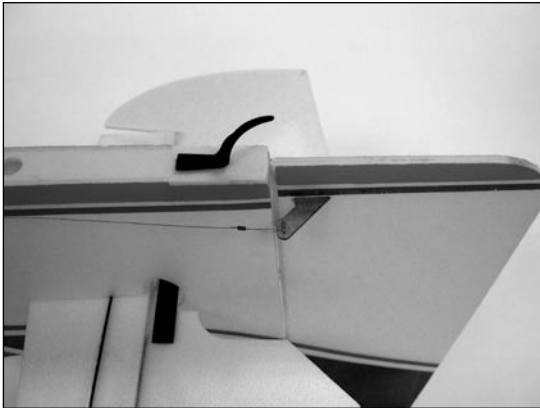

- 2. Install the landing gear into position by pressing up into the landing gear mount.



**Note:** Use a small amount of foam-safe CA if the landing gear is loose in the slot.



- 3. Install the landing gear fairings and wheel pants using hot glue. We recommend gluing the wire to the fairings only at the two ends.



- 4. Install the wheels using the wheel retainers and a drop of foam-safe CA on the end to secure the retainer.



- 5. Now that the landing gear has been installed, we can install the strut fences to the bottom of the bottom wing. They are angled 25 degrees towards the wing tip as shown.

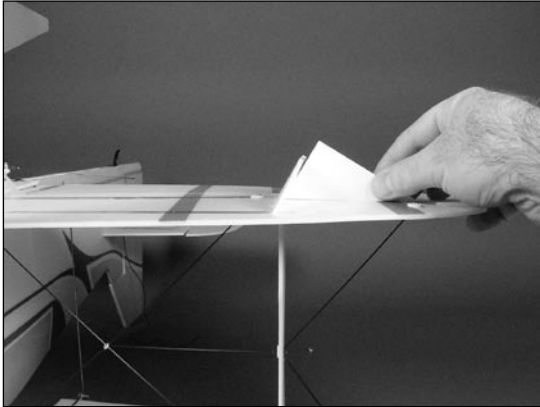

**Note:** A template has been provided to achieve this angle. It is located on page 37. Please cut this template out and use it for alignment.

## Center of Gravity / Battery Installation

### **Required Parts**

- Airframe
- Battery (480mAh, 3-cell, 11.1 V Li-Po, JST (THP4803SJ)
- Hook and loop

**Note:** A 730mAh 3-cell 11.1 V Li-Po (THP7303SJPL) battery can be used as an option to the 480mAh, 3-cell 11.1 V Li-Po battery. This battery will provide longer flight times.

An important part of preparing the aircraft for flight is properly balancing the model.

**Caution:** Do not inadvertently skip this step!

The recommended Center of Gravity (CG) location for the Byp Yak is  $3\frac{1}{4}$ " (82mm) behind the leading edge of the top wing.

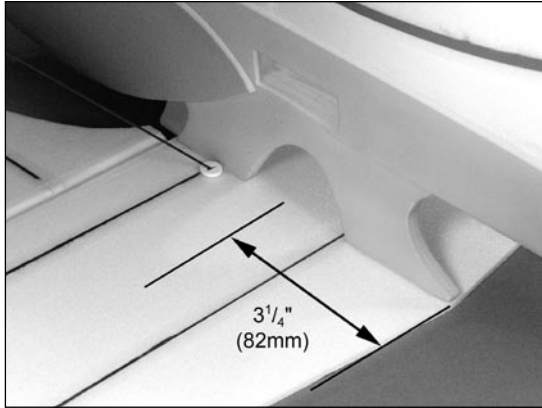

The battery is located as shown in the photo. Secure the battery using hook and loop material. It may be necessary to move either the ESC or receiver to achieve the correct Center of Gravity.

Weights can be used if necessary, but will add to the overall flying weight of your model. This would be a last resort to achieve the correct CG.

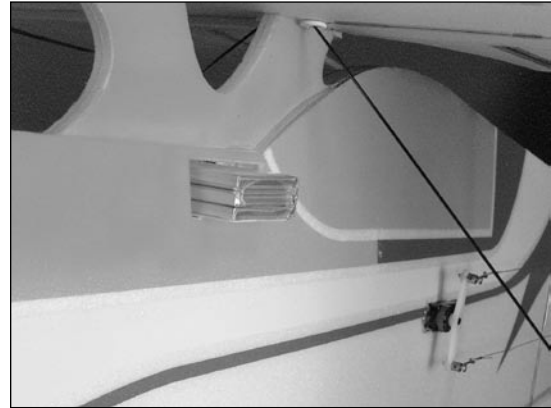

## Control Throws

---

You may set your control throws up for a less sensitive setup for your first flights. Pilots not used to extremely maneuverable 3D aircraft, and the use of large amounts of expo may also chose to program dual rates with significantly less throw.

|           |                  |                    |
|-----------|------------------|--------------------|
| Aileron:  | 2 1/2" (64mm) up | 2 1/2" (64mm) down |
| Elevator: | 3" (76mm) up     | 3" (76mm) down     |
| Rudder:   | 3" (76mm) left   | 3" (76mm) right    |

The throws below are the same as those used by Quique Somenzini (used with the expo values shown at the right).

|           |                 |                  |
|-----------|-----------------|------------------|
| Aileron:  | 3" (76mm) up    | 3" (76mm) down   |
| Elevator: | 4" (102mm) up   | 4" (102mm) down  |
| Rudder:   | 4" (102mm) left | 4" (102mm) right |

## Quique Somenzini's Competition Radio Setup

---

These numbers represent the exact radio setup programmed into Quique's personal 9303 transmitter to control his Byp Yak, using only 1 flight mode. Set the travel settings on all flight control channels (Aileron, Elevator, and Rudder) to approximately 140-150%. Make sure you do not overdrive the servos causing stalling of the servos and excess current draw.

### ***Dual Rates and Exponential Rates***

|           |                |          |
|-----------|----------------|----------|
| Rudder:   | Dual Rate 100% | Expo 50% |
| Aileron:  | Dual Rate 100% | Expo 78% |
| Elevator: | Dual Rate 100% | Expo 63% |

### ***Programmable Mix 1: Rudder to Elevator Mixing***

Select Rudd - Elev

SW Select

Thro Stk INH

Expo ON

Point 0 +2

Point 1 +2

Point 2 INH

Point 3 0

Point 4 +1

Point 5 0

Point 6 -1

### ***Programmable Mix 2: Aileron to Rudder Mixing***

Pos 0:

L +14%

R +9%

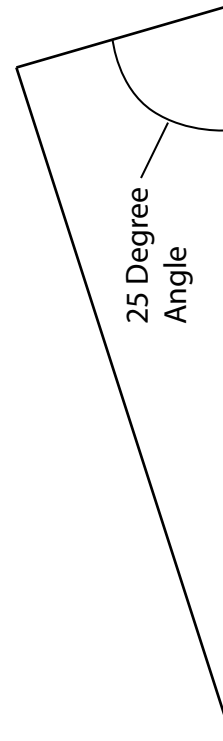

## 2006 Official AMA National Model Aircraft Safety Code

---

### GENERAL

- 1) I will not fly my model aircraft in sanctioned events, air shows or model flying demonstrations until it has been proven to be airworthy by having been previously, successfully flight tested.
- 2) I will not fly my model higher than approximately 400 feet within 3 miles of an airport without notifying the airport operator. I will give right-of-way and avoid flying in the proximity of full-scale aircraft. Where necessary, an observer shall be utilized to supervise flying to avoid having models fly in the proximity of full-scale aircraft.
- 3) Where established, I will abide by the safety rules for the flying site I use, and I will not willfully or deliberately fly my models in a careless, reckless and/or dangerous manner.
- 4) The maximum takeoff weight of a model is 55 pounds, except models flown under Experimental Aircraft rules.

5) I will not fly my model unless it is identified with my name and address or AMA number on or in the model. (This does not apply to models while being flown indoors.)

6) I will not operate models with metal-bladed propellers or with gaseous boosts, in which gases other than air enter their internal combustion engine(s); nor will I operate models with extremely hazardous fuels such as those containing tetranitromethane or hydrazine.

### RADIO CONTROL

- 1) I will have completed a successful radio equipment ground range check before the first flight of a new or repaired model.
- 2) I will not fly my model aircraft in the presence of spectators until I become a qualified flier, unless assisted by an experienced helper.

## 2006 Official AMA National Model Aircraft Safety Code

---

3) At all flying sites a straight or curved line(s) must be established in front of which all flying takes place with the other side for spectators. Only personnel involved with flying the aircraft are allowed at or in front of the flight line. Intentional flying behind the flight line is prohibited.

4) I will operate my model using only radio control frequencies currently allowed by the Federal Communications Commission. (Only properly licensed Amateurs are authorized to operate equipment on Amateur Band frequencies.)

5) Flying sites separated by three miles or more are considered safe from site-to-site interference, even when both sites use the same frequencies. Any circumstances under three miles separation require a frequency management arrangement, which may be either an allocation of specific frequencies for each site or testing to determine that freedom from interference exists. Allocation plans or interference test reports shall be signed by the parties involved and provided to AMA Headquarters.

Documents of agreement and reports may exist between (1) two or more AMA Chartered Clubs, (2) AMA clubs and individual AMA members not associated with AMA Clubs, or (3) two or more individual AMA members.

6) For Combat, distance between combat engagement line and spectator line will be 500 feet per cubic inch of engine displacement. (Example: .40 engine = 200 feet.); electric motors will be based on equivalent combustion engine size. Additional safety requirements will be per the RC Combat section of the current Competition Regulations.

7) At air shows or model flying demonstrations, a single straight line must be established, one side of which is for flying, with the other side for spectators.

8) With the exception of events flown under AMA Competition rules, after launch, except for pilots or helpers being used, no powered model may be flown closer than 25 feet to any person.

9) Under no circumstances may a pilot or other person touch a powered model in flight.

***E-flite***<sup>TM</sup>

**HORIZON**  
H O B B Y

© 2006 Horizon Hobby, Inc.  
4105 Fieldstone Road  
Champaign, Illinois 61822  
(877) 504-0233  
***horizonhobby.com***  
***E-fliteRC.com***