

PT-19 ARF

Assembly Manual



Specifications

Wingspan:	45 in (1440mm)
Length:	36 in (910mm)
Wing Area:	310 sq in (19.9 sq dm)
Weight w/o Battery:	22-24 oz (680-740 g)
Weight w/Battery:	27-29 oz (820-880 g)

Pilots not included (available separately)

Table of Contents

Introduction	2
Important Information Regarding Warranty Information.....	2
Using the Manual.....	2
Contents of Kit/Parts Layout.....	2
Covering Colors.....	2
Recommended Radio Equipment, Radio Controlled Version.....	3
Recommended Equipment, Control Line Version	3
Optional Accessories.....	3
Brushless Outrunner Setup	3
Required Tools and Adhesives.....	3
Note on Lithium Polymer Batteries	3
Warning.....	4
Construction Options.....	4
Fixed Aileron Linkage Installation CL Option	4
Aileron Servo and Linkage Installation RC Option	6
Joining the Wing Panels, RC and CL Options.....	10
Landing Gear Installation RC/CL options	13
Stabilizer and Fin Installation RC/CL Options.....	14
Rudder Servo Installation CL Option	16
Rudder Servo Installation RC Option.....	18
Elevator Bellcrank Installation CL Option	20
Elevator Servo Installation RC Option	22
Receiver Installation RC Option	24
Speed Control Installation, RC/CL Options.....	25
Motor Installation RC/CL Options.....	26
Cowling and Propeller Installation, RC/CL Options	27
Motor Battery Placement RC/CL Options	30
Wing Installation, RC/CL Options	31
Leadout Guide Installation and Tip Weight Box CL Option	31
Pilot Installation (Optional) RC/CL Options	33
Control Throws.....	33
Center of Gravity	34
Preflight.....	34
Range Test Your Radio	35
Control Line Flying Checklist	35
Safety, Precautions and Warnings	38
Safety Do's and Don'ts for Pilots.....	38
Warranty Information.....	39
Instructions for Disposal of WEEE by Users in the European Union	40
2008 Official Academy of Model Aeronautics Safety Code.....	40
Building and Flying Notes.....	42-43

Introduction

During WWII, the PT-19 Cornell was one of the primary training aircraft for the Army Air Corps. The PT-19 had a higher wing loading and higher stall speed that helped pilots in training learn more than the current biplane trainers.

E-flite's version of the PT-19 is a scale, almost-ready-to-fly, electric model designed for radio control with the option of control line. It's 90% pre-built out of the box and boasts an appealing USAAC trim scheme for a great scale appearance. Those modelers who enjoy radio controlled flying can complete this ARF with the recommended E-flite® Park 450 or high-powered Park 480 motor. The PT-19 features an easily accessible magnetic battery hatch and steerable tail wheel for improved ground handling.

The PT-19 can also be flown as a control line plane. All of the internal control line completion hardware is included, while the ESC timer, wooden control handle and spool of wire cable is available separately.

Control line flying will allow the airplane to be flown by two cables that connect the model to the operator through the optional control line handle and allow the operator's hand movement to guide the model.

Either way you choose, the flying options are yours with the E-flite PT-19.

Important Information Regarding Warranty Information

Please read our Warranty and Liability Limitations section on Page 39 before building this product. If you as the Purchaser or user are not prepared to accept the liability associated with the use of this Product, you are advised to return this Product immediately in new and unused condition to the place of purchase.

Using the Manual

This manual is divided into sections to help make assembly easier to understand, and to provide breaks between each major section. In addition, check boxes have been placed next to each step to keep track of its completion. Steps with a single circle (○) are performed once, while steps with two circles (○○) indicate that the step will require repeating, such as for a right or left wing panel, two servos, etc.

Remember to take your time and follow the directions.

Contents of Kit/Parts Layout

Replacement Parts

EFL2676	Wing Set
EFL2677	Fuselage Set
EFL2678	Tail Set
EFL2679	Cowling
EFL2680	Landing Gear
EFL2681	Pushrod Set
EFL2682	Fuselage Hatch
EFL2683	Windscreens
EFL2684	C/L Bellcrank Assembly
EFL2685	Hardware Package
EFLA219	Tailwheel Assembly



Covering Colors

HANU872	Bright Yellow
HANU885	Midnight Blue

Recommended Radio Equipment, Radio Controlled Version

You will need a minimum of a 4-channel transmitter, receiver and four servos. You can choose to purchase a complete radio system. If you are using an existing transmitter, just purchase the other required equipment separately. We recommend the crystal-free, interference-free Spektrum™ DX5e 2.4GHz DSM® 5-channel system. If using your own transmitter, we recommend the E-flite S75 Sub-Micro servos.

If you own a Spektrum radio, just add a DSM2™ receiver and four E-flite S75 Sub-Micro servos. We show the installation of the AR6100 receiver in the manual.

Radio System

SPM5500 DX5e DSM2 5CH system

Or Purchase Separately any of the Following Receivers

SPMAR500 AR500 DSM2 5-Channel Full-Range Receiver (for DX5e, DX6i or DX7)

SPMAR6100 AR6100 DSM2 6-Channel Park Flyer Receiver (for DX5e, DX6i, or DX7)

SPMAR6100E AR6100E DSM2 6-Channel Park Flyer Receiver (for DX5e, DX6i, or DX7)

SPMAR6200 AR6200 DSM2 6-Channel Full Range Receiver (for DX5e, DX6i, or DX7)

And

EFLRS75 7.5-gram Sub-Micro Servo (4)

EFLREX6L 6-inch Extension, Lightweight (2)

EFLRYH3 3-inch Y-harness, Lightweight

The Spektrum trademark is used with permission of Bachmann Industries, Inc.

Recommended Equipment, Control Line Version

EFLA170 Control Line Handle
EFLA171 52' Braided Steel Lines
EFLA172 Control Line Motor Timer
SIGSH561 Sig Mfg Lead Balancing Weight (1/4 ounce)

Optional Accessories

EFLA110 Power Meter
EFLC3005 Celecra™ 1- to 3-Cell Li-Po Charger
EFLC505 Intelligent 1- to 5-Cell Balancing Charger
EFLA150 Military Pilot (1 or 2)

Brushless Outrunner Setup

EFLM1400 Park 450 Brushless Outrunner Motor, 890Kv
APC10070E 10x7 Electric Propeller
EFLP1080E 10X8 Electric Propeller
EFLA1030 30-Amp Pro Switch-Mode BEC Brushless ESC

or

EFLM1505 Park 480 Brushless Outrunner Motor, 1020Kv
APC12060E 12x6 Electric Propeller
EFLA1040L 40-Amp Lite Pro Switch-Mode BEC Brushless

and

EFLA172 Motor Timer (control line only)
EFLB21003S 2100mAh 3S 11.1V 20C Li-Po, 13AWG EC3

Required Tools and Adhesives

Tools & Equipment

Card stock	Epoxy brushes
Low-tack tape	Medium grit sandpaper
Mixing cups	Mixing sticks
Paper towels	Pencil
Pin drill	Pliers
Rubbing alcohol	Ruler
Scissors	Square
String/dental floss	T-pins
Trim seal tool	Phillips screwdriver: #0, #1
Felt-tipped pen	Rubber bands (optional)
Heat gun	Sealing iron
Hobby knife (#11 blade)	
Nut driver: 1/4-inch, 5.5mm	
Hex wrench or ball driver: 1.5mm, 3/32-inch	
Drill bit: 1/16-inch (1.5mm), 1/8-inch (3mm)	

Adhesives

Threadlock	30-Minute Epoxy (HAN8002)
Thin CA	6-Minute Epoxy (HAN8000)

Note on Lithium Polymer Batteries



Lithium Polymer batteries are significantly more volatile than alkaline or Ni-Cd/Ni-MH batteries used in RC applications. All manufacturer's instructions and warnings must be followed closely. Mishandling of Li-Po batteries can result in fire. Always follow the manufacturer's instructions when disposing of Lithium Polymer batteries.

Warning

An RC aircraft is not a toy! If misused, it can cause serious bodily harm and damage to property. Fly only in open areas, preferably at AMA (Academy of Model Aeronautics) approved flying sites, following all instructions included with your radio.

Keep loose items that can get entangled in the propeller away from the prop, including loose clothing, or other objects such as pencils and screwdrivers. Especially keep your hands away from the propeller.

E-tips

During the course of building your PT-19 ARF we suggest that you use a soft base for the building surface. Such things as a foam stand, large piece of bedding foam or a thick bath towel will work well and help protect the model from damage during assembly.

Construction Options

Your PT-19 can be built a variety of ways. The two different options are either Radio Control (RC) or Control Line (CL). The RC version has the ability to be transformed from RC to CL and back to RC again with only a few minutes of work. For those who would like to build the model solely as a CL model, you will find a section dedicated to this in the beginning of construction when installing the aileron linkages. You will find in bold print at each section, what version it is for. Either RC or CL will determine what the step is for. Please note that there is a section at the end of the manual as to what is required to lock the ailerons in place for CL flying if you have built the RC version.

Fixed Aileron Linkage Installation CL Option

Required Parts

- Wing panel (left and right)
- Aileron pushrod wire, 2 1/2-inch (65mm) (2)
- Control line servo cover (left and right)
- Brass pushrod connector (2)
- Pushrod connector backplate (2)
- 2mm x 4mm machine screw (2)
- 2mm x 8mm sheet metal screw (8)

Required Tools and Adhesives

- Phillips screwdriver: #1
- Pliers
- Low-tack tape

This section details the installation of the aileron linkage for the control line version of the PT-19. If you are building the radio controlled version, please skip to the next section.

1. Remove the aileron servo cover from the wing and set it aside. You will be using a different cover, but you may want to save this cover for use later if you convert your aircraft to radio control.



2. Insert the end of the 2 1/2-inch (65mm) aileron linkage in the outside hole of the aileron control horn.

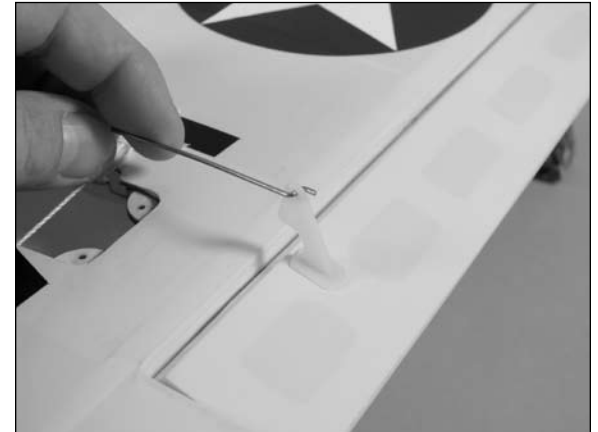
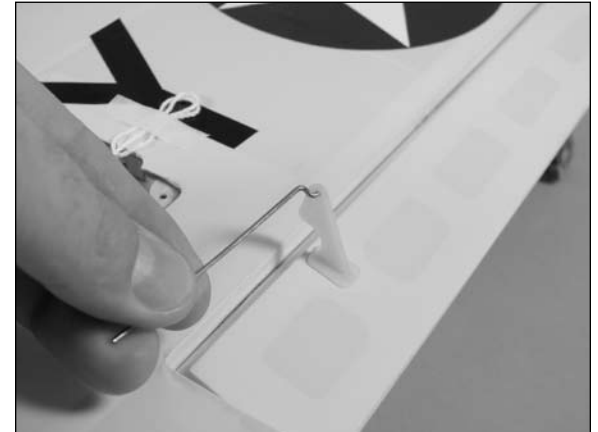

- 3. Remove the string from the bottom of the wing and tape it inside the wing. You may want to convert you PT-19 to radio control at some time, and the string will be helpful in pulling the servo extension from the aileron servo through the wing when you do.



- 4. Locate the aileron cover for the control line version of your model. Insert the brass pushrod connector into the outside hole of the control line aileron servo cover. Use a pushrod connector backplate and pliers to secure the connector.

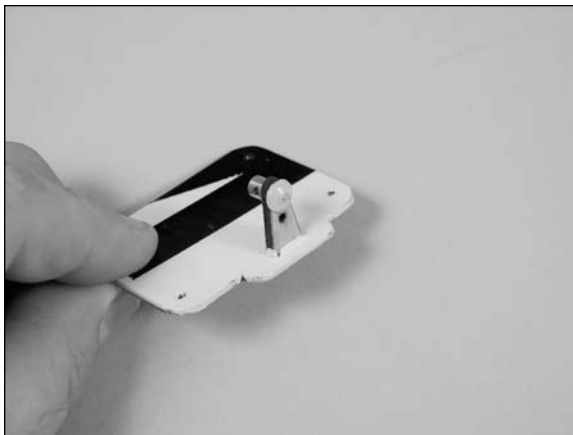

- 5. Use a #1 Phillips screwdriver and four 2mm x 8mm sheet metal screws to secure the aileron servo cover to the wing.



- 6. Slide the aileron pushrod through the hole in the brass pushrod connector.



- 7. Use a small piece of low-tack tape to hold the aileron centered for the next step.



- 8. Use a #1 Phillips screwdriver and a 2mm x 4mm machine screw to secure the aileron pushrod wire. Remove the low-tack tape from the aileron at this time as well.



- 9. Repeat steps 1 through 8 to install the remaining cover and aileron linkage.

Aileron Servo and Linkage Installation RC Option

Required Parts

Radio system	Wing panel (left and right)
Servo (2)	
Connector backplate (2)	
Brass pushrod connector (2)	
2mm x 4mm machine screw (2)	
2mm x 8mm sheet metal screw (8)	
6-inch (152mm) servo extension (2)	
Aileron pushrod wire, 2 1/2-inch (65mm) (2)	

Required Tools and Adhesives

Pin drill	Drill bit: 1/16-inch (1.5mm)
Pencil	Phillips screwdriver: #0, #1
6-minute epoxy	Medium grit sandpaper
Mixing cup	Mixing stick
Thin CA	String/dental floss
Pliers	Low-tack tape

This section details the installation of the aileron linkage for the radio controlled version of the PT-19. If you are building the control line version and have already installed the aileron linkage, please skip this section of the manual.

- 1. Use the radio system to center the aileron servos. Use a #0 Phillips screwdriver to remove the control horns and install them on the servos as shown. Prepare a left and right aileron servo at this time.

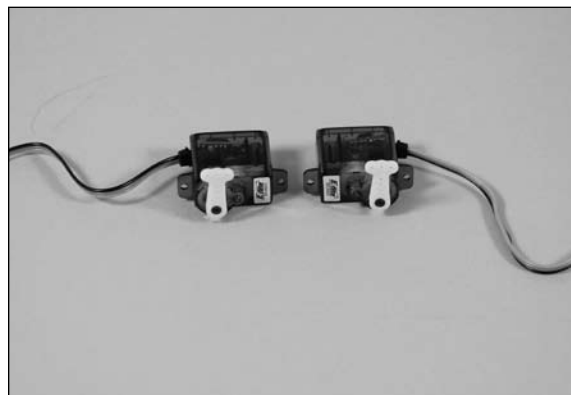

- 2. Use a pin drill and 1/16-inch (1.5mm) drill bit to enlarge the center outer hole of the servo arm as shown.



- 3. Insert the brass pushrod connector into the hole. Use pliers and the connector backplate to secure the brass pushrod connector to the servo arm.



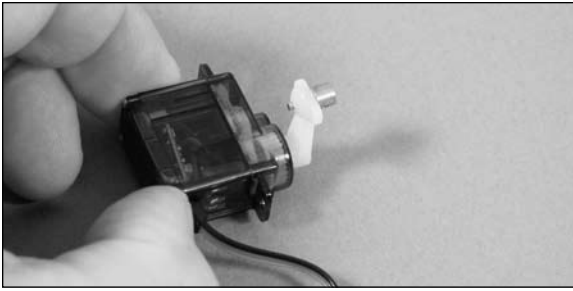

- 4. Carefully remove the servo cover from the wing panel.

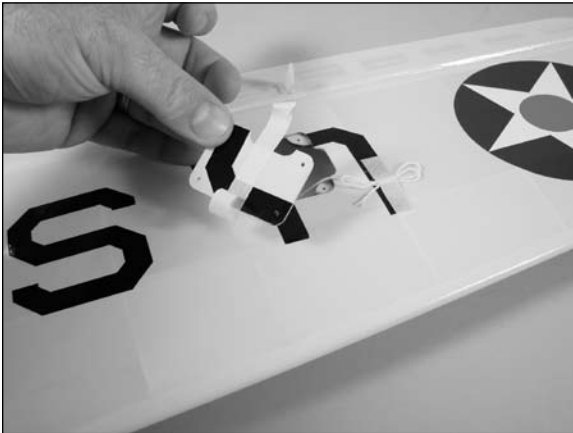

- 5. Position the servo on the servo cover. Center the servo arm in the cutout in the servo cover as shown.

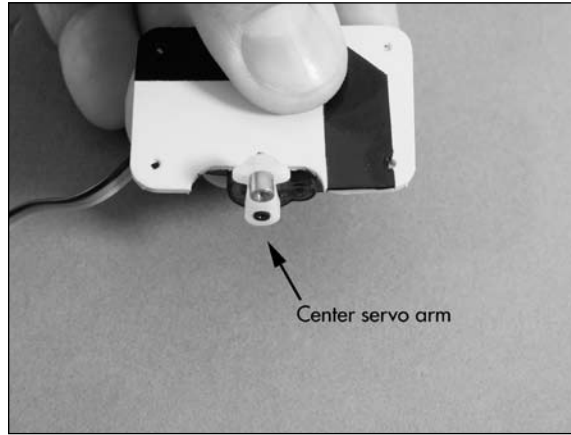

- 6. The servo arm will also be flush with the edge of the servo cover as shown when it is positioned properly.

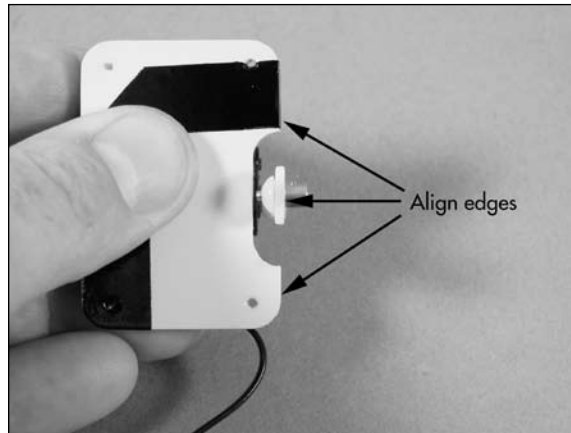

- 7. Once the servo is properly positioned, use a pencil to trace the servo tabs and servo edges on the servo cover.

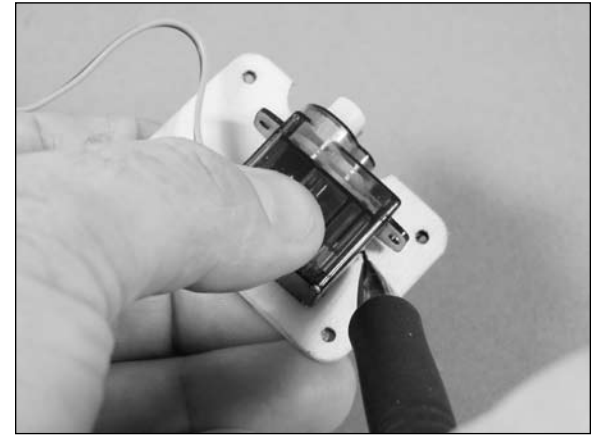

- 8. Check to make sure the servo mounting block does not overhang the edge of the servo cover. If so, you will need to adjust the position of the servo to make sure both blocks will be on the servo cover.



- 9. Use a piece of medium grit sandpaper to roughen the ends of the servo mounting blocks. This will help the epoxy to adhere to the blocks and provide a more secure bond between the blocks and servo cover.

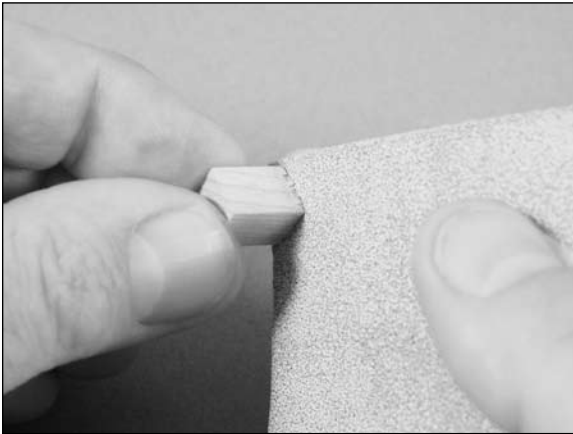

- 10. Mix a small amount of 6-minute epoxy. Use the epoxy to glue the blocks to the servo cover. Use the lines drawn on the servo cover to properly position the block.



- 11. Repeat the steps 2 through 10 to glue the blocks on the remaining servo cover at this time. Allow the epoxy to fully cure before proceeding.

- 12. Once the epoxy has fully cured, position the servo between the servo mounting blocks.

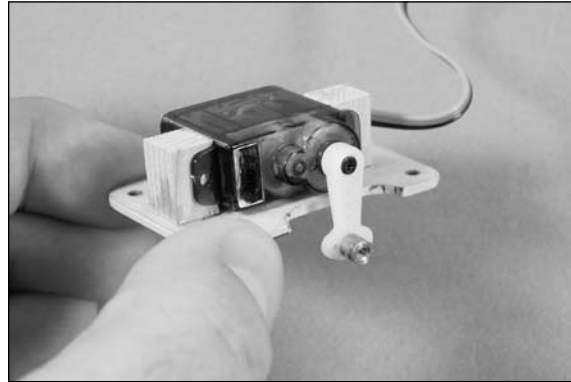

- 13. Use a pencil to mark the positions for the servo mounting screws onto the mounting blocks.

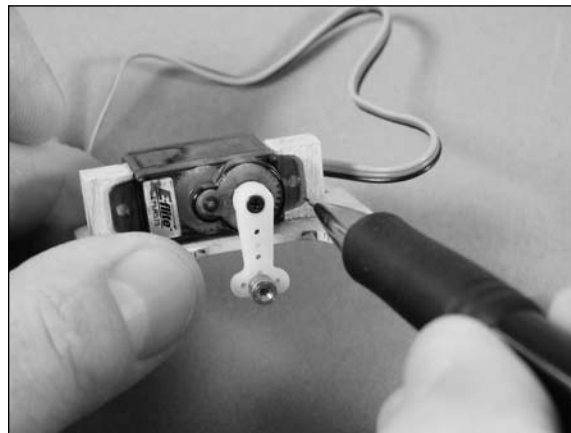
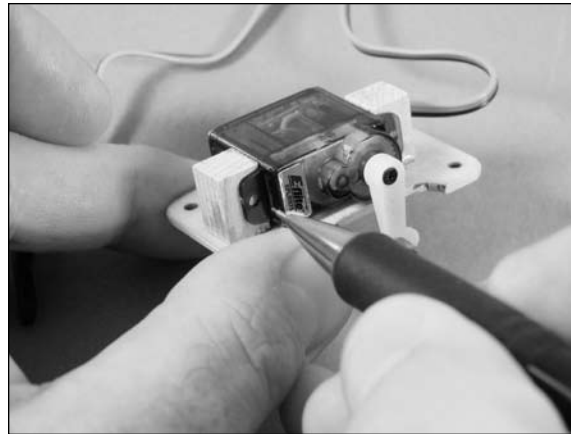

- 14. Use a pin drill and 1/16-inch (1.5mm) drill bit to drill a hole in each mounting block at the position marked in the previous step.

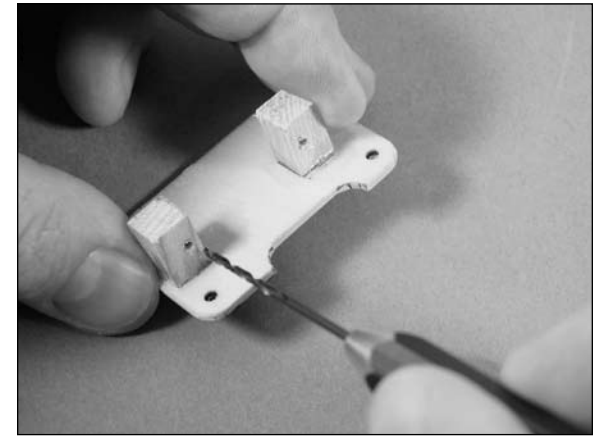

- 15. Place 2-3 drops of thin CA into each of the holes to harden the surrounding wood. This will provide a harder surface for the screws to bite into and make them more secure when installed.

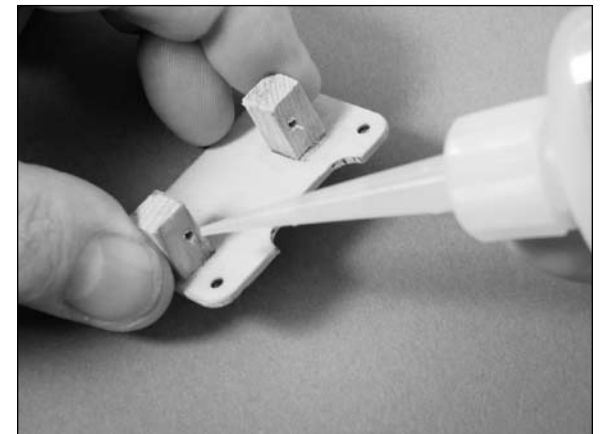

- 16. Mount the servo to the blocks using the two screws provided with the servo. Use a #1 Phillips screwdriver to tighten the screws.

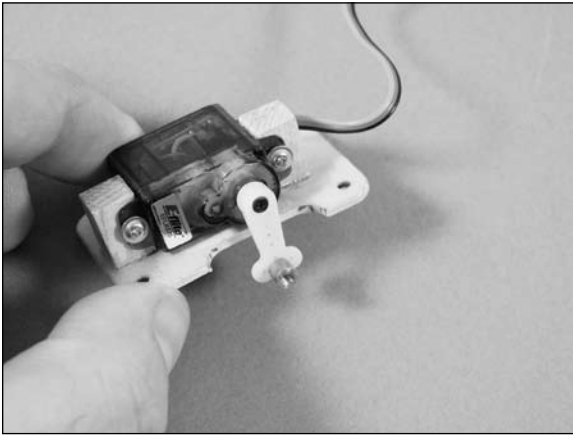

- 17. Connect a 6-inch (152mm) servo extension to the lead from the aileron servo.

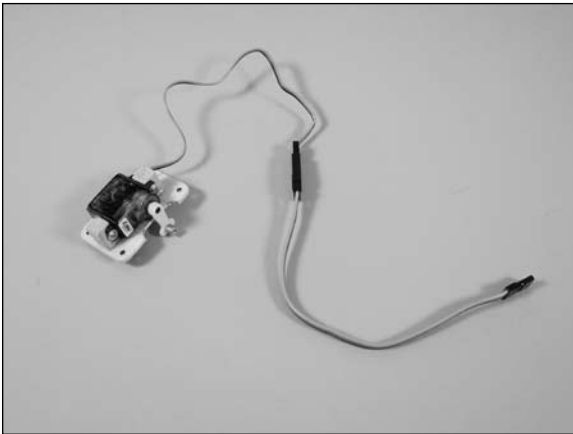

- 18. Use string or dental floss to secure the extension to the servo lead so they do not become unplugged inside the wing.

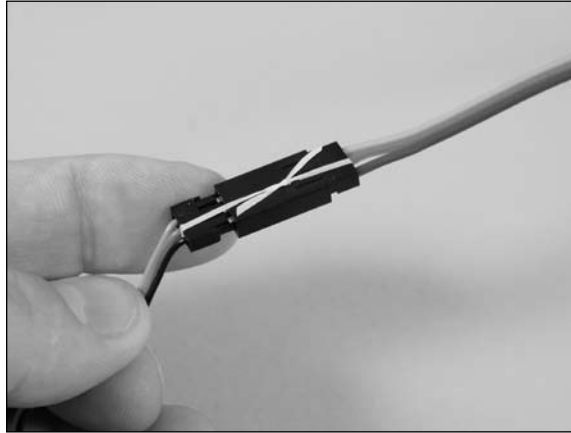
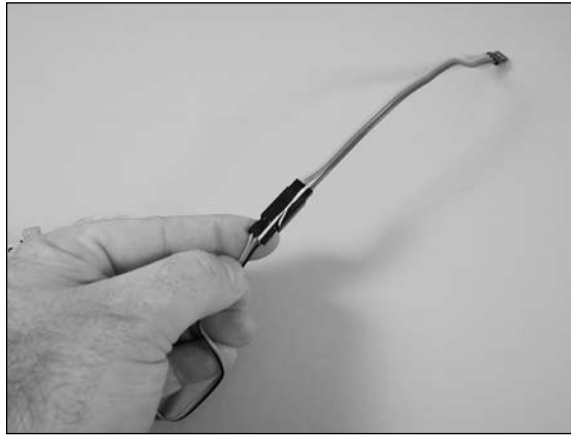

E-tips

If using string or dental floss to secure your servo lead, we place a very small drop of thin CA onto the knot to ensure it does not untie over time.

- 19. Remove the tape from the string near the aileron servo opening in the wing. Tie the string to the end of the aileron servo extension. Use the string to pull the extension through the wing and out of the hole near the center of the wing as shown.

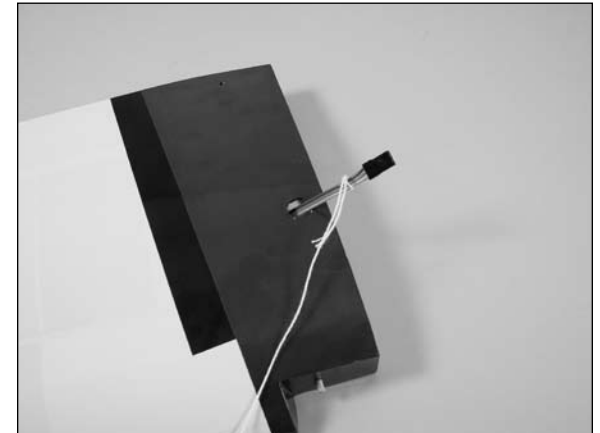
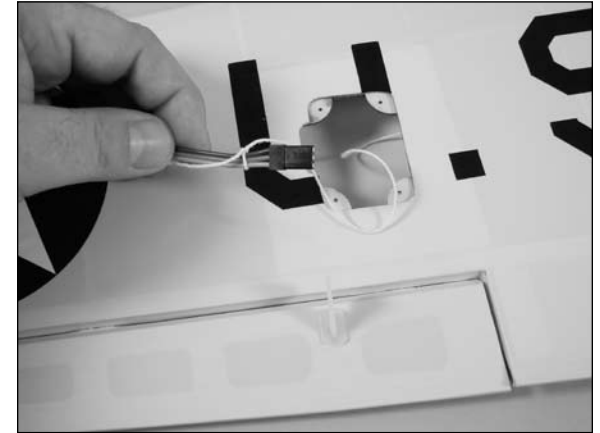

- ○ 20. Use a #1 Phillips screwdriver to install the four 2mm x 8mm sheet metal screws that secure the aileron servo cover to the wing.

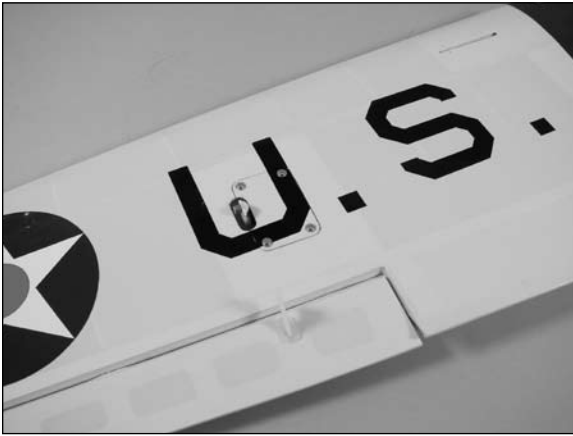

- ○ 21. Insert the Z-bend end of the 2 1/2-inch (65mm) aileron linkage in the outside hole of the aileron control horn.



- ○ 22. Insert the aileron pushrod in the hole of the brass connector pushrod. Once the pushrod is inserted into the connector, center the aileron using low tack tape.

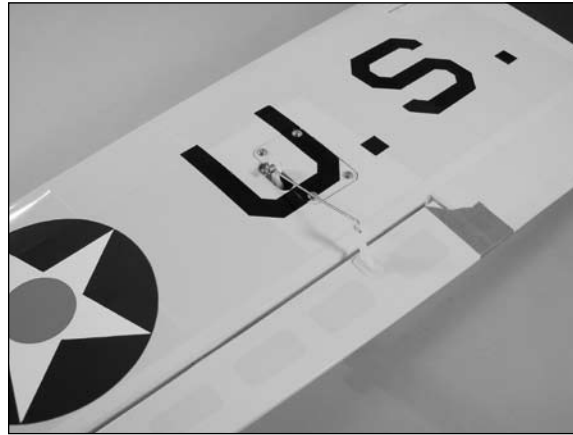

- ○ 23. Make sure the aileron servo is centered from Step 1. Use a #1 Phillips screwdriver and 2mm x 4mm machine screw to secure the aileron pushrod in the brass pushrod connector. Once connected, remove the low tack tape from the aileron.



- ○ 24. Repeat steps 12 through 23 to mount the remaining aileron servo to the servo cover and install the aileron linkage.

Joining the Wing Panels, RC and CL Options

Required Parts

Wing panel (right and left) Wing joiner
4-40 x 1-inch socket head screw (2) (optional)

Required Tools and Adhesives

30-minute epoxy Paper towel
Mixing cup Mixing sticks
Epoxy brush Rubbing alcohol
T-pin Low-tack tape
Square Pencil
Sandpaper: medium grit
Rubber bands (optional)

- 1. Use a pencil to mark the wing panel and wing joiner. This is necessary as you will need to be able to return the joiner back to the panels in which it was fitted.



- 2. Place the joiner on the work surface. With the square aligned with the high point of the joiner, use a pencil to make the centerline on the joiner.

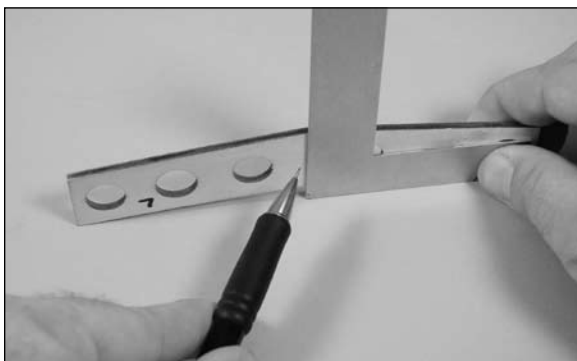

- 3. Slide the joiner into the appropriate wing panel up to the line drawn in the previous step. If the joiner does not slide in easily, it may be necessary to lightly sand the joiner to correct the fit. Repeat the process to fit the joiner into both wing panels.

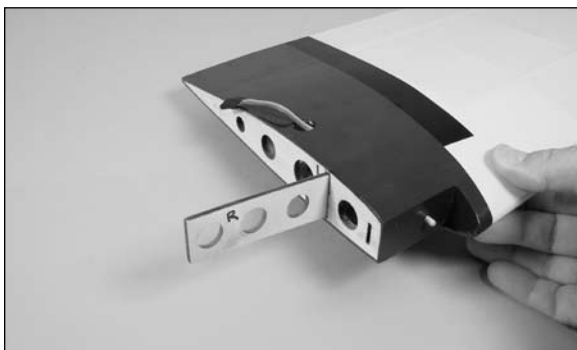
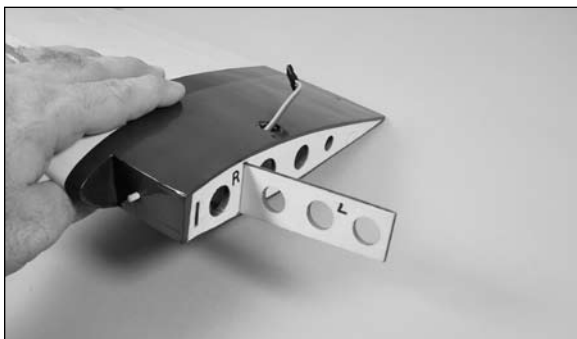

- 4. Place a T-pin lightly in the center of the joiner. This will allow the joiner to fit centered in each wing panel when installed.

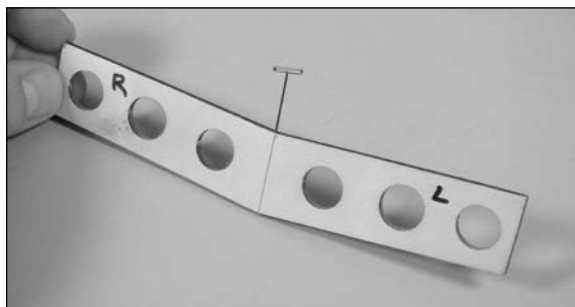

- 5. Mix 1/2 ounce (15ml) of 30-minute epoxy and using an epoxy brush apply the epoxy to the root of one wing panel.



- 6. Use a mixing stick to apply the epoxy into the joiner pocket of the wing panel.



- 7. Apply epoxy to the end of the wing joiner that will be inserted into the wing panel. Make sure to cover the front, back, top and bottom of the joiner.

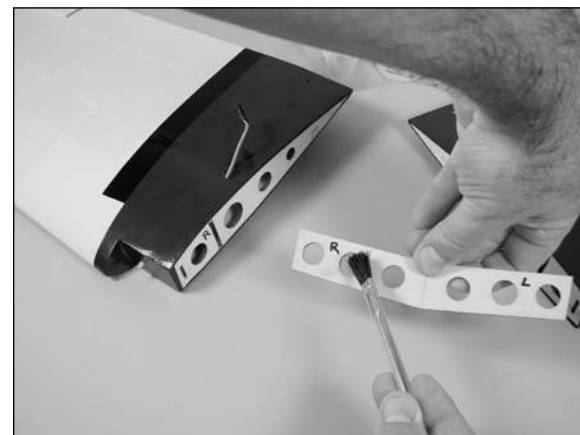

- 8. Slide the joiner into the wing panel. Work slowly so the epoxy can be cleaned using a paper towel and rubbing alcohol as the joiner is inserted into the panel. Once the joiner is inserted, apply epoxy to all edges of the exposed joiner.



Etips

Excess epoxy will ooze out of the joiner pocket as the joiner is inserted. If it does not, you have not used enough epoxy. Repeat steps 6 and 7 to apply more epoxy to the joiner and into the joiner pocket.

- 9. Apply epoxy in the joiner pocket and root of the remaining wing panel.



- 10. Slide the wing panels tightly together. Remove the T-pin from the joiner that was installed in Step 4. Slide the wing panels tightly together. Again, work slowly to clean up any excess epoxy using a paper towel and rubbing alcohol.

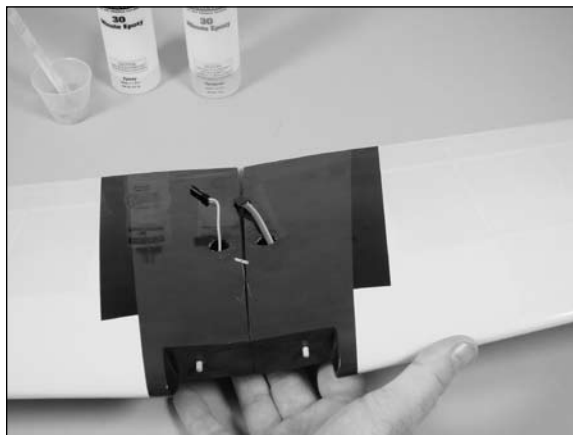

- 11. Use low-tack tape to hold the two wing panels together until the epoxy fully cures. Clean any excess epoxy from the wing panels using rubbing alcohol and a paper towel.

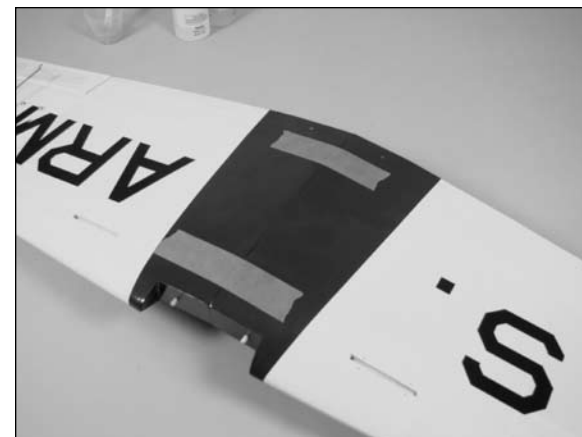
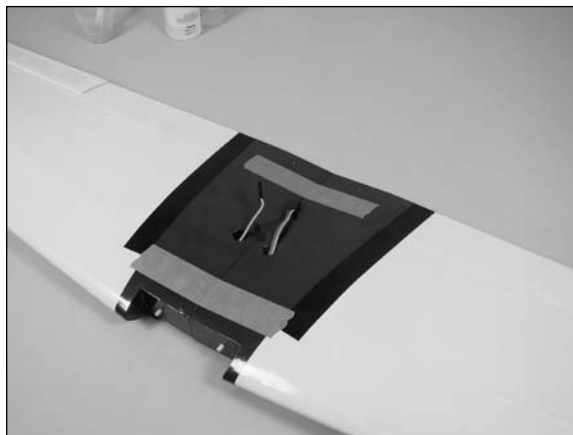

E-tips

You can use the two 4-40 x 1-inch socket head wing bolts and three rubber bands to hold the wings together while the epoxy cures. Simply insert the wing bolts half-way into the holes at the trailing edge and wrap a rubber band around the bolts on both the top and bottom of the wing. Use a third rubber band around the wing dowels. Always clean up any excess epoxy using a paper towel and rubbing alcohol.

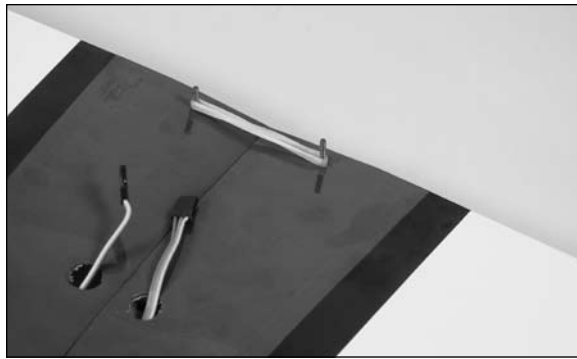

Landing Gear Installation RC/CL options

Required Parts

- Assembled wing
- Main landing gear assembly (2)
- Landing gear strap (4)
- 2mm x 8mm sheet metal screw (8)

Required Tools and Adhesives

- Phillips screwdriver: #1
- Hex wrench: 1.5mm
- Hobby knife with #11 blade

A 1.5mm allen wrench has been supplied for you in case you need to remove the wheels at any given time.

1. Locate one of the pre-assembled main landing gear. There is not a right and left, so either one will work. Insert the landing gear into the pre-drilled hole in the landing gear block on the bottom of the wing. Press the gear into the block so it is flush with the bottom of the wing.

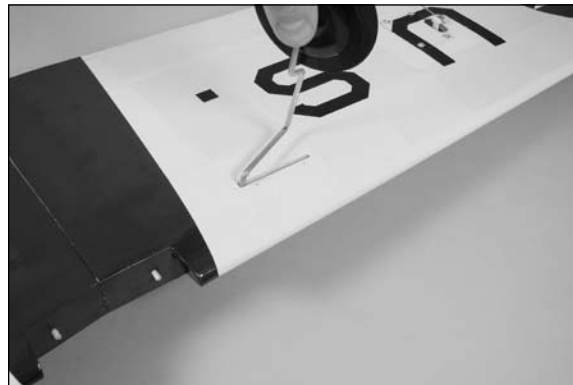

Etips

You might find that sometimes the landing gear wire may not fully seat in the landing gear block. This is because of the radius on the bend of the wire. Use a small round file or #11 blade to remove a slight amount of material from the landing gear block allowing the wire gear to fully seat in the block.



- ○ 2. Use two landing gear straps and four 2mm x 8mm sheet metal screws to secure the landing gear to the bottom of the wing. Use a #1 Phillips screwdriver to tighten the four screws.

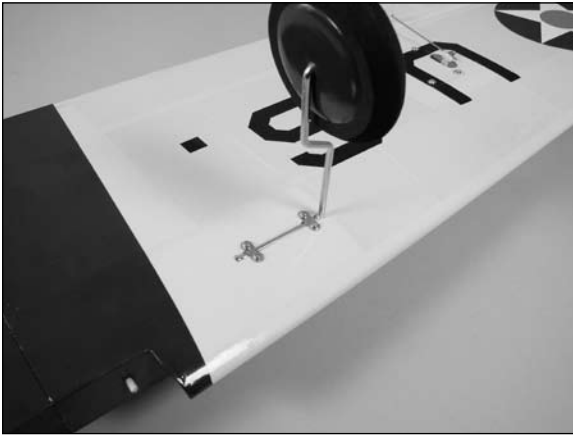

- 3. Repeat Steps 1 and 2 to install the remaining main landing gear to the bottom of the wing.

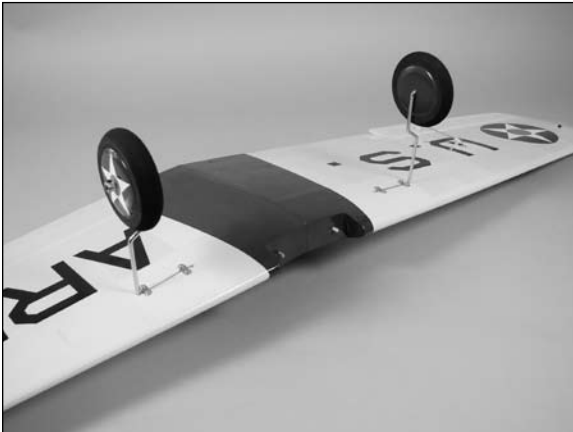

Stabilizer and Fin Installation RC/CL Options

Required Parts

Stabilizer assembly Vertical fin assembly
 #4 washer (4) 4-40 locknut (2)
 Fuselage
 4-40 x 1/2-inch socket head screw (2)
 Rudder pushrod wire, 18 ³/₈-inch (467mm)
 Elevator pushrod wire, 20 ¹/₂-inch (521mm)

Required Tools and Adhesives

Threadlock Nut driver: 1/4-inch
 Ball driver or hex wrench: 3/32-inch

- 1. Locate the horizontal stabilizer and determine the top and bottom as shown in the photos below. The top will have the blind nuts, and the control horn will face to the bottom.

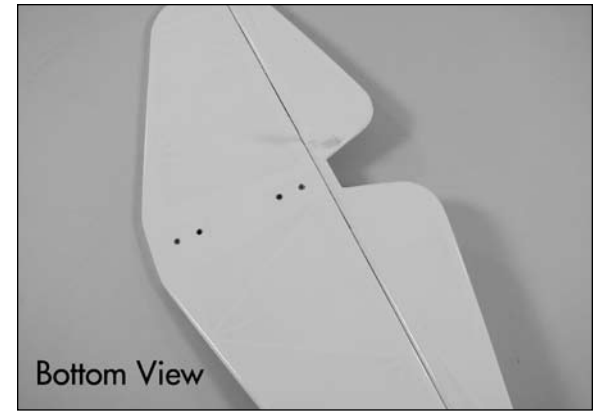
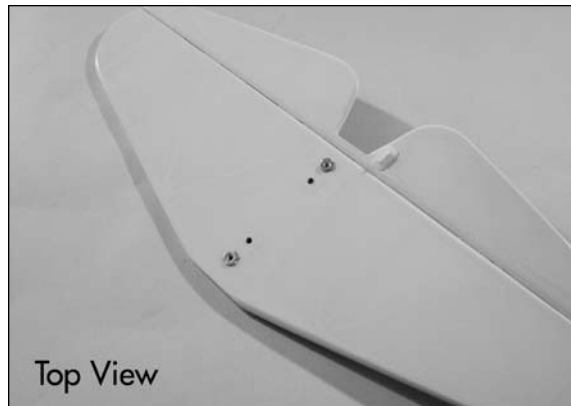

- 2. Locate the vertical fin assembly. Slide the threaded rods from the fin through the holes in the stabilizer. The blind nuts in the stabilizer will fit into the recesses in the vertical fin fairing.

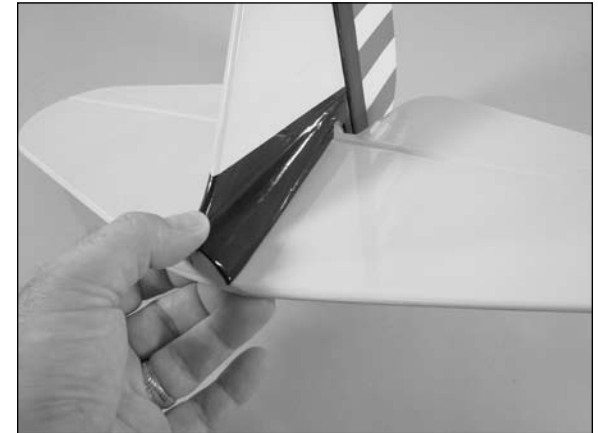

- 3. Slide a #4 washer onto each of the threaded rods exposed on the bottom of the stabilizer.



- 4. Use a 1/4-inch nut driver to install a 4-40 locknut on each of the threaded rods. Do not over-tighten the nuts and damage the structure of the stabilizer. They only need to be tight enough to prevent the fin from moving when it is installed.



- 5. Locate the 18 ³/₈-inch (467mm) rudder pushrod. Insert the Z-bend in the pushrod into the center hole of the rudder control horn as shown.



- 6. Locate the 20 ¹/₂-inch (521mm) elevator pushrod. Insert the Z-bend in the pushrod into the center hole of the elevator control horn as shown.



- 7. Insert the elevator and rudder pushrods into the pushrod tubes at the rear of the fuselage.

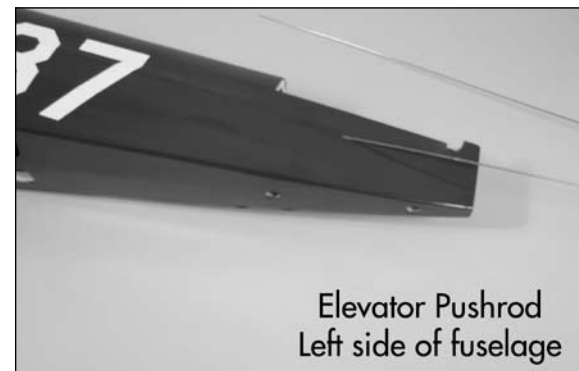

Elevator Pushrod
Left side of fuselage



Rudder Pushrod
Right side of fuselage

- 8. Slide the tail assembly forward so it is resting in position at the rear of the fuselage as shown below.



- 9. Slide a #4 washer on a 4-40 x 1/2-inch socket head screw. Prepare two of these to secure the tail to the fuselage.



- 10. Insert a 4-40 screw and washer into each of the holes at the rear of the fuselage. Use a 3/32-inch ball driver or hex wrench to tighten the two screws. Do not over-tighten the screws and damage the structure of the stabilizer or fuselage. They only need to be tight enough to prevent the assembly from moving when it is installed.



Etips

Always use threadlock on metal-to-metal fasteners to prevent them from vibrating loose.

Rudder Servo Installation CL Option

Required Parts

Fuselage assembly
Rudder linkage stay
Connector backplate
Brass pushrod connector
2mm x 4mm machine screw
2mm x 8mm sheet metal screw (2)

Required Tools and Adhesives

Pin drill Drill bit: 1/16-inch (1.5mm)
Pencil Thin CA
Pliers Phillips screwdriver: #1
Ruler

- 1. Remove the cockpit hatch by lifting it upward at the rear and sliding it back slightly to release the pegs at the front. Set the cockpit hatch aside.

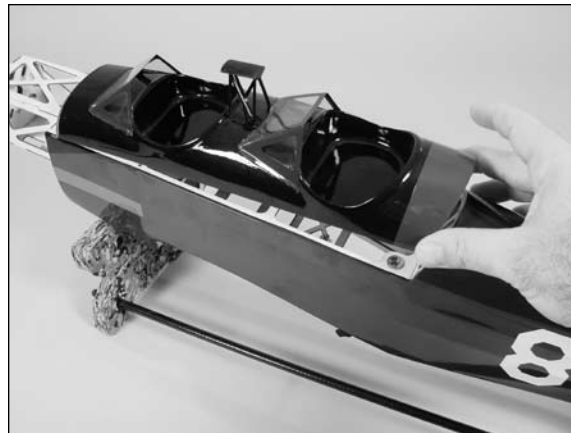

- 2. Insert the brass pushrod connector into the outer hole of the rudder linkage stay. Use pliers and the connector backplate to secure the brass pushrod connector.

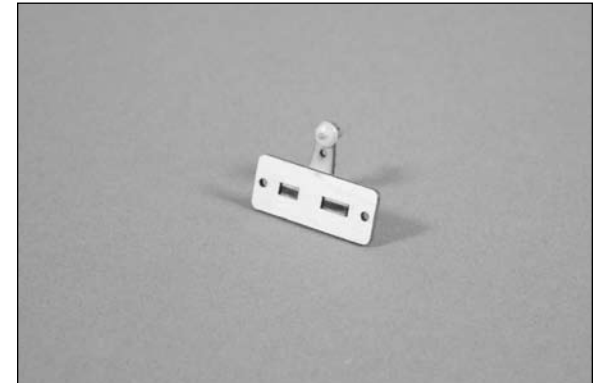

- 3. Center the rudder linkage stay over the opening in the servo tray inside the fuselage with the pushrod connector toward the tail of the fuselage. Use a pencil to mark the positions for the servo mounting screws onto the servo tray.



- 4. Remove the rudder servo. Use a pin drill and 1/16-inch (1.5mm) drill bit to drill a hole in the servo tray at the position marked in the previous step.



- 5. Place 2-3 drops of thin CA into each of the holes to harden the surrounding wood. This will provide a harder surface for the screws to bite into and make them more secure when installed.

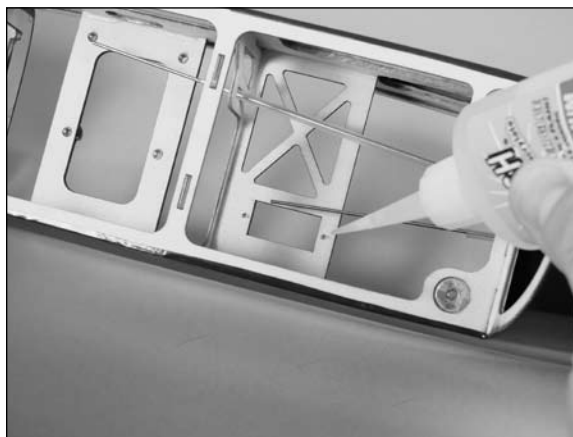

- 6. Mount the rudder linkage stay to the servo tray using two 2mm x 8mm sheet metal screws. Use a #1 Phillips screwdriver to tighten the screws. Slide the pushrod into the pushrod connector at this time.

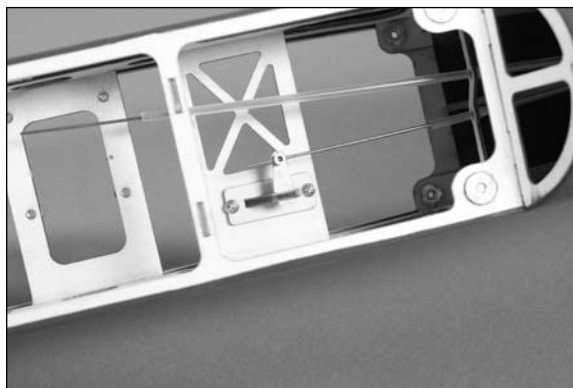

- 7. Position the rudder so there is a small amount of offset to the rudder as shown. This is necessary as the model will fly in a counterclockwise rotation and needs right rudder for the offset. The amount of offset is not extremely critical for the PT-19. Measuring at approximately 3/8-1/2 inch of right offset will deliver a nice strong pull during flight without any bad tendencies during basic maneuvering.



E-tips

We recommend 1/2 inch rudder offset for your first flights if you have not flown CL before or it has been a long time since that last flight. You can reduce this over time to meet the personalized feel and performance of your PT-19.

- 8. Use a #1 Phillips screwdriver and 2mm x 4mm machine screw to secure the rudder pushrod in the brass pushrod connector.

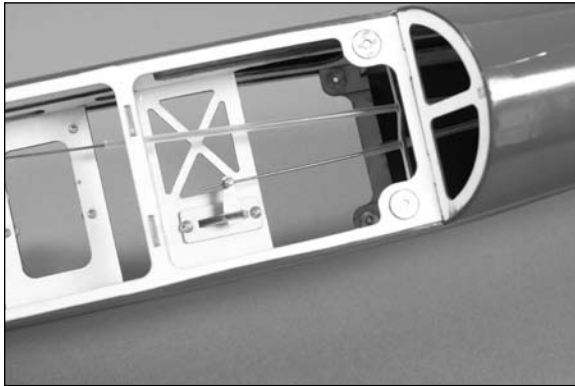

Rudder Servo Installation RC Option

Required Parts

Rudder servo	Brass pushrod connector
Fuselage assembly	Connector backplate
Radio system	
2mm x 4mm machine screw	

Required Tools and Adhesives

Pin drill	Drill bit: 1/16-inch (1.5mm)
Pencil	Thin CA
Pliers	Phillips screwdriver: #1
Ruler	

- 1. Remove the cockpit hatch by lifting it upward at the rear and sliding it back slightly to release the pegs at the front. Set the cockpit hatch aside.

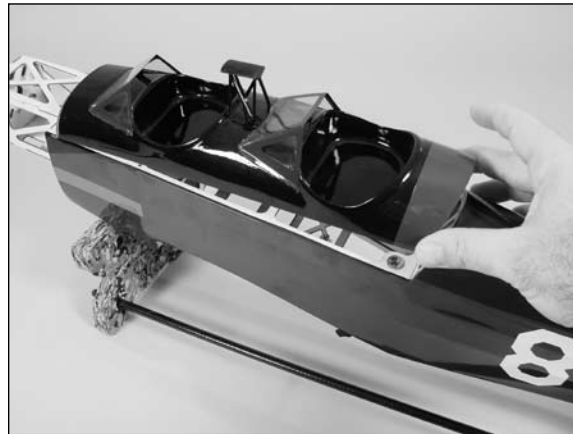

- 2. Plug the rudder servo into the receiver. Power up the receiver and transmitter to center the rudder servo. Make sure the rudder trim at the radio has been centered and the end points (if using a computer radio) have been set to 100%. Use a pin drill and 1/16-inch (1.5mm) drill bit to enlarge the center outer hole of the servo arm as shown.

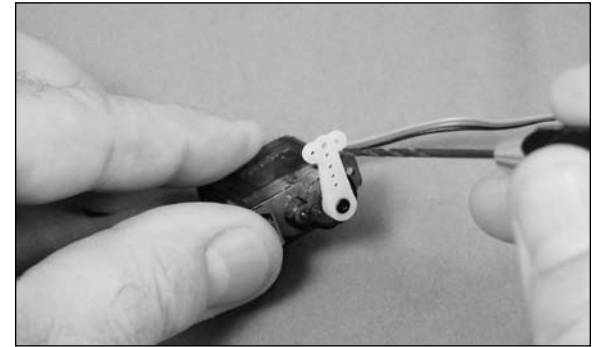

- 3. Insert the brass pushrod connector into the hole drilled in the previous step. Use pliers and the connector backplate to secure the brass pushrod connector to the servo arm.

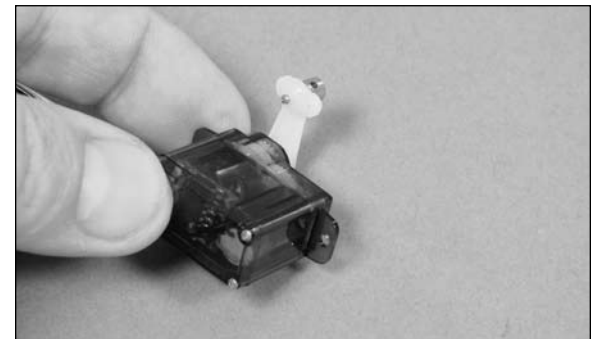
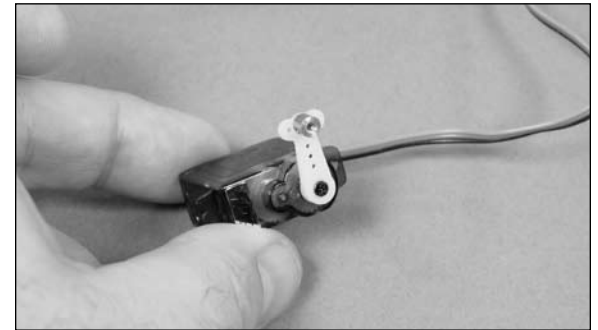

- 4. Insert the rudder servo into the opening in the servo tray inside the fuselage with the output shaft toward the tail of the fuselage. Use a pencil to mark the positions for the servo mounting screws onto the servo tray.

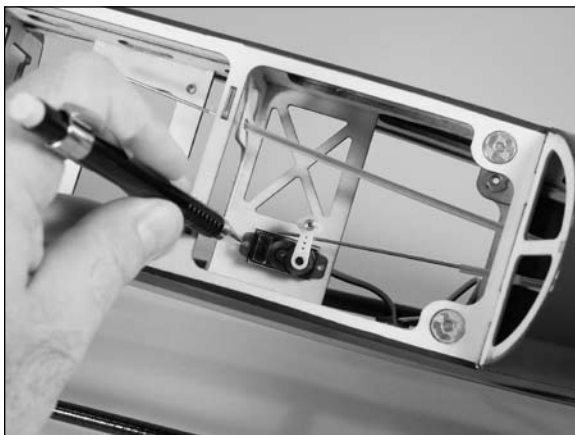

- 5. Remove the rudder servo. Use a pin drill and 1/16-inch (1.5mm) drill bit to drill a hole in the servo tray at the position marked in the previous step.



- 6. Place 2-3 drops of thin CA into each of the holes to harden the surrounding wood. This will provide a harder surface for the screws to bite into and make them more secure when installed.

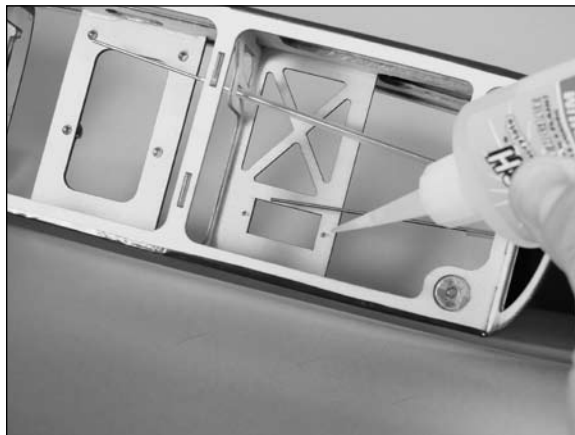

- 7. Mount the servo to the servo tray using the two screws provided with the servo. Use a #1 Phillips screwdriver to tighten the screws. Slide the pushrod into the pushrod connector at this time.



- 8. Use a ruler placed against the rudder and fin to align the rudder with the fin.



- 9. Check to make sure the rudder servo is centered using the radio system. Use a #1 Phillips screwdriver and 2mm x 4mm machine screw to secure the rudder pushrod in the brass pushrod connector.



Elevator Bellcrank Installation CL Option

Required Parts

Wing assembly Fuselage assembly
#4 washer (4) Brass pushrod connector
4-40 x 1/2-inch socket head screw (4)
Connector backplate
2mm x 4mm machine screw
Elevator bellcrank assembly

Required Tools and Adhesives

Hobby knife with #11 blade
Pliers Nut driver: 5.5mm
Ruler Phillips screwdriver: #1
Felt-tipped pen Trim seal iron

This section details the installation of the elevator bellcrank for the control line version of the PT-19. If you are building the radio controlled version, please skip to the next section. If you plan on using your model for both RC and CL, then you will want to perform the steps in this section.

- 1. Use a hobby knife with a new #11 blade to cut a slit in the covering on the left side of the fuselage for the elevator leadout wires to exit. Also cut a slit in the left wing tip for the leadout wire guide to fit into the wing.

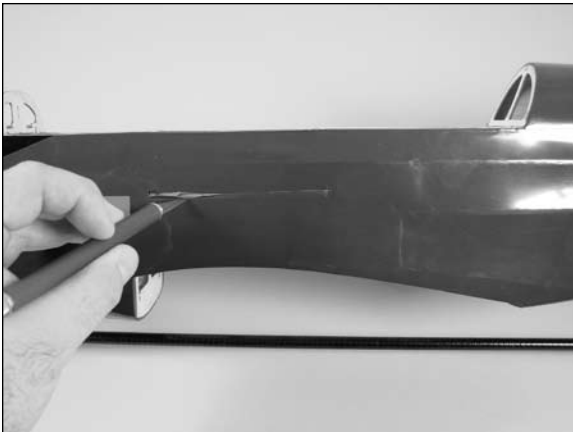

- 2. Use a trim seal iron to iron the covering at the fuselage and wing tip to create a finished look to your model.



- 3. Use a felt-tipped pen to mark the top of the elevator bellcrank as shown. This is necessary as the bellcrank must be disassembled to fit into the fuselage and returned to its proper position when reassembled.

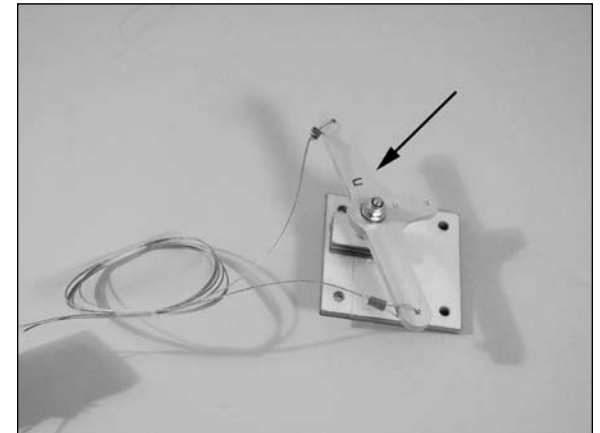

- 4. Use a 5.5mm nut driver to remove the nut from the bellcrank assembly. Remove the flanged washer and bellcrank from the bellcrank assembly base. Place all items aside for later.

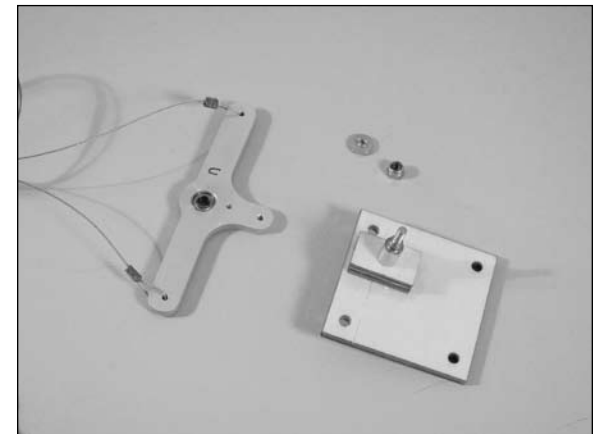

- 5. Use four 4-40 x 1/2-inch socket head screws and four #4 washers to secure the bellcrank base inside the fuselage. Note that the threaded stud for the bellcrank is facing the slot in the fuselage for the leadout wires.



- 6. Slide the elevator bellcrank into the fuselage through the slot exposed in Step 1.



- 7. Insert the brass pushrod connector into the hole in the elevator bellcrank. Use pliers and the connector backplate to secure the brass pushrod connector to the elevator bellcrank.

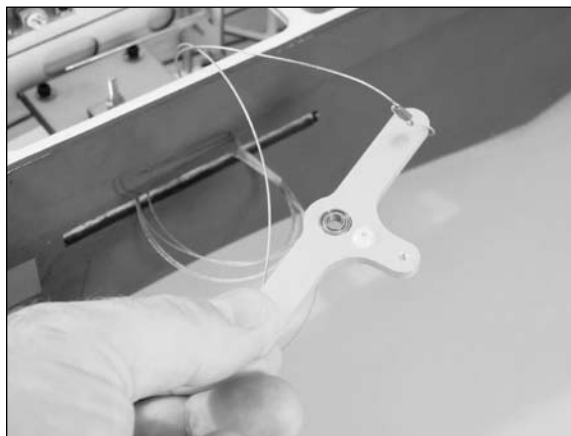

E-tips

You will note in the pictures we have installed the pushrod connector in the inner hole on the bellcrank. This will provide good solid control inputs for your first flights. Later on, you may move to the outside hole for even more throw if you so wish.

- 8. Carefully inspect the flanged washer. It must be installed in the correct direction for the bellcrank to operate smoothly. The narrow part of the flange will fit against the bearing in the bellcrank, and the wide edge faces the nut holding the assembly together.

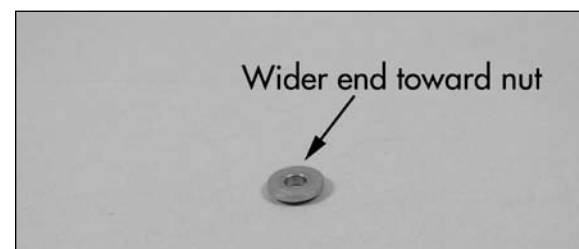
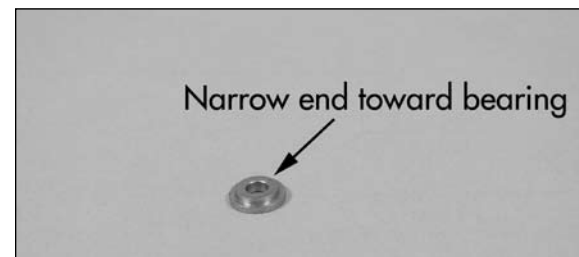

- 9. Slide the bellcrank onto the threaded stud. Make sure the mark made in Step 3 is facing up. Slide the flanged washer onto the threaded stud (not the correct direction as described in the previous step) and use the nut and 5.5mm nut driver to tighten the nut. Snug the nut down to prevent damage to the bearing in the bellcrank. Insert the elevator pushrod into the hole in the brass pushrod connector.



- 10. Use a ruler placed against the stabilizer and elevator to align the stabilizer with the elevator.

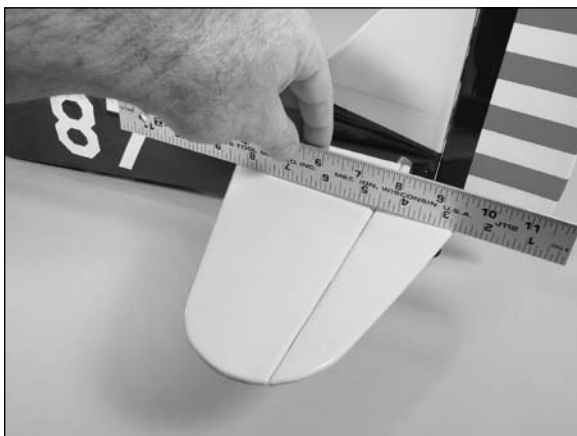

- 11. Align the elevator bellcrank with the center line of the fuselage.

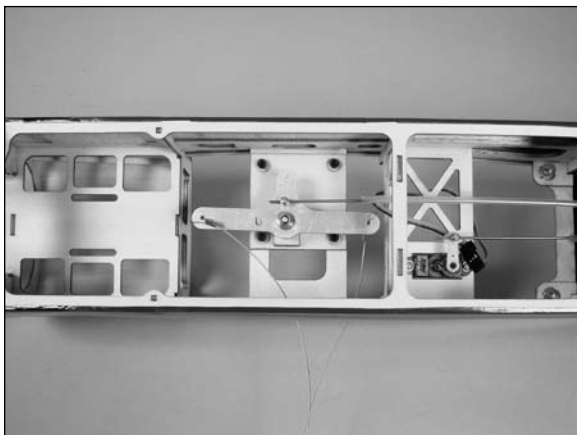

- 12. Use a #1 Phillips screwdriver and 2mm x 4mm machine screw to secure the elevator pushrod in the brass pushrod connector.



E-tips

If you have opted to fly the PT-19 as both a Control Line and Radio Control model you will need to remove the bellcrank at this time to prepare for the elevator servo installation as these two items are interchangeable and use the same mount.

Elevator Servo Installation RC Option

Required Parts

Elevator servo	Brass pushrod connector
Fuselage assembly	Connector backplate
4-40 x 1/2-inch socket head screw (4)	
#4 washer (4)	Elevator servo tray
Radio system	
2mm x 4mm machine screw	

Required Tools and Adhesives

Pin drill	Drill bit: 1/16-inch (1.5mm)
Pencil	Thin CA
Pliers	Phillips screwdriver: #1
Ruler	
Hex wrench or ball driver: 3/32-inch	

This section details the installation of the elevator servo for the radio controlled version of the PT-19. If you are building the control line version and have installed the elevator bellcrank, please skip to the Motor Installation section of the manual. Please note the hardware to mount the bellcrank platform in the airplane is the same as used to mount the elevator servo plate in the airplane.

- 1. Use a 3/32 inch hex wrench or ball driver to install four 4-40 x 1/2-inch socket head screws and four #4 washers to secure the elevator servo tray inside the fuselage. Note that the opening for the servo faces to the left side of the fuselage.



- 2. Plug the elevator servo into the receiver. Power up the receiver and transmitter to center the elevator servo. Make sure the elevator trim at the radio has been centered and the end points (if using a computer radio) have been set to 100%. Use a pin drill and 1/16-inch (1.5mm) drill bit to enlarge the center outer hole of the servo arm as shown.

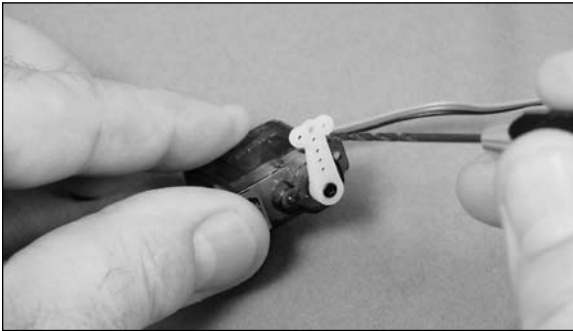

- 3. Insert the brass pushrod connector into the hole drilled in the previous step. Use pliers and the connector backplate to secure the brass pushrod connector to the servo arm.

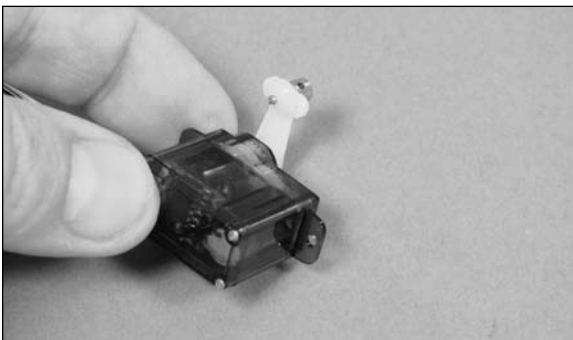
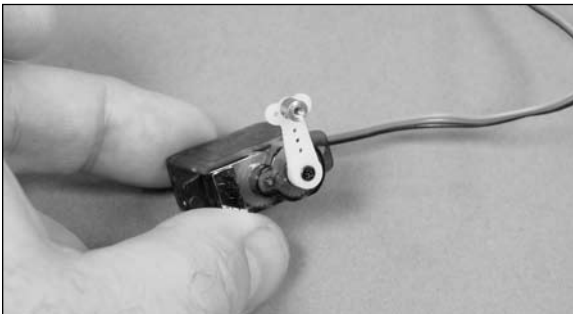

- 4. Insert the elevator servo into the opening in the servo tray inside the fuselage with the output shaft toward the tail of the fuselage. Use a pencil to mark the positions for the servo mounting screws onto the servo tray.

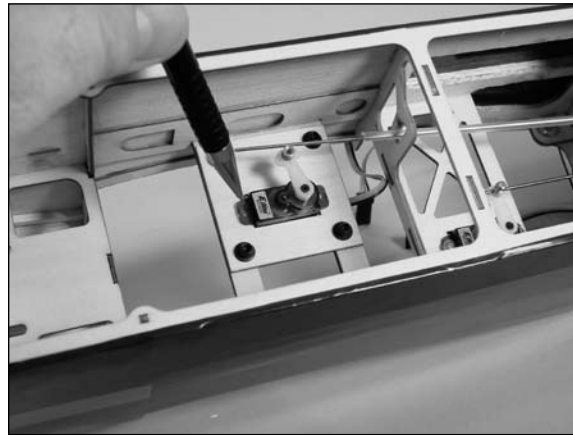

- 5. Remove the elevator servo. Use a pin drill and 1/16-inch (1.5mm) drill bit to drill a hole in the servo tray at the position marked in the previous step.

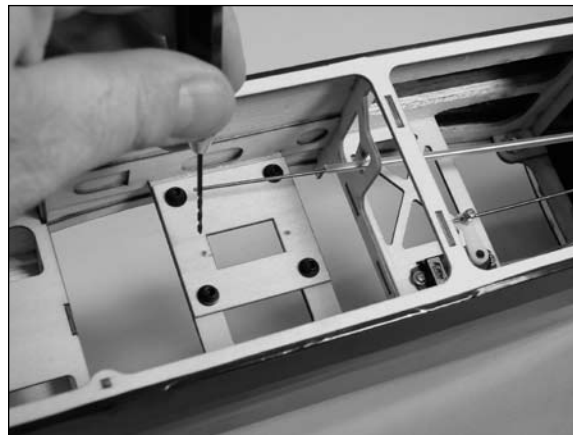

- 6. Place 2-3 drops of thin CA into each of the holes to harden the surrounding wood. This will provide a harder surface for the screws to bite into and make them more secure when installed.

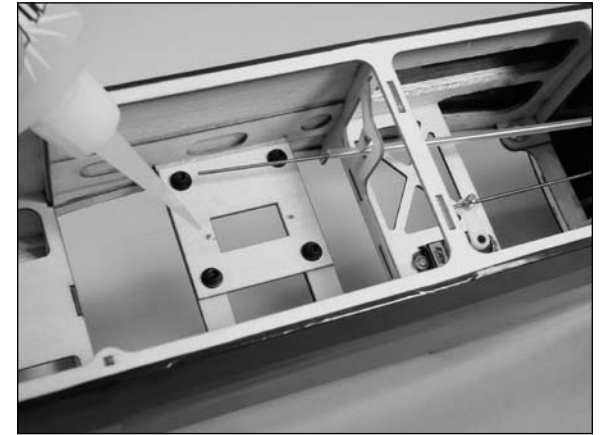

- 7. Slide the pushrod into the brass connector and insert the servo into the servo tray. Mount the servo to the servo tray using the two screws provided with the servo. Use a #1 Phillips screwdriver to tighten the screws.

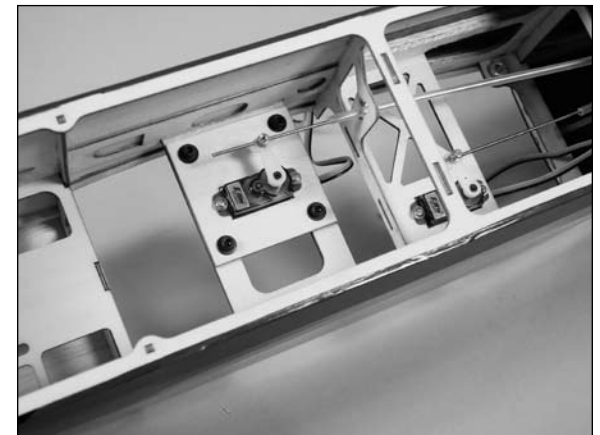

- 8. Use a ruler placed against the stabilizer and elevator to align the stabilizer with the elevator.



- 9. Check to make sure the elevator servo is centered using the radio system. Use a #1 Phillips screwdriver and 2mm x 4mm machine screw to secure the elevator pushrod in the brass pushrod connector.

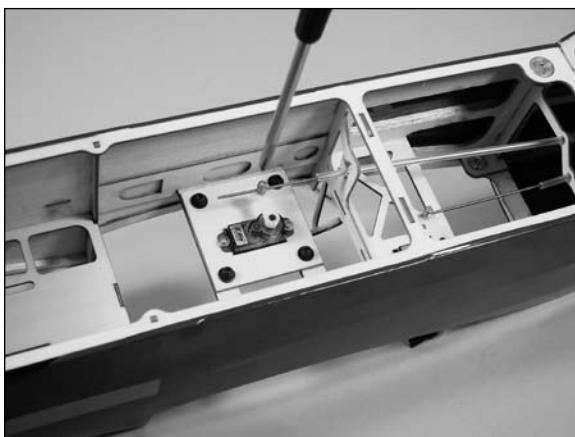

Receiver Installation RC Option

Required Parts

Receiver Fuselage assembly
Hook and loop tape

Required Tools and Adhesives

Scissors

This section details the installation of the receiver for the radio controlled version of the PT-19. If you are building the control line version, please skip to the Motor Installation section of the manual.

- 1. Use scissors to cut a piece of hook and loop tape the size of your receiver. Apply one side of the tape to the receiver.

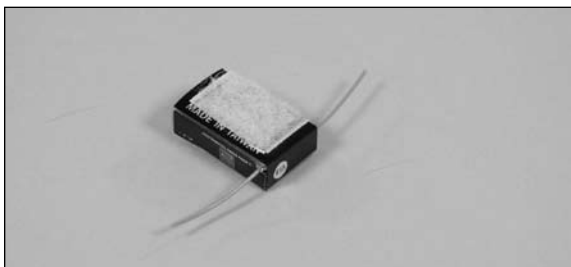

- 2. Apply the remaining side of the hook and loop tape from Step 1 to the radio tray as shown. This is done through the wing opening.

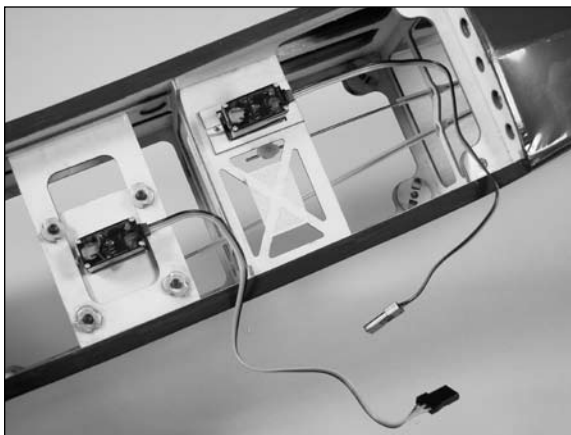

- 3. Position the receiver on the tray. The hook and loop tape will keep it secure.

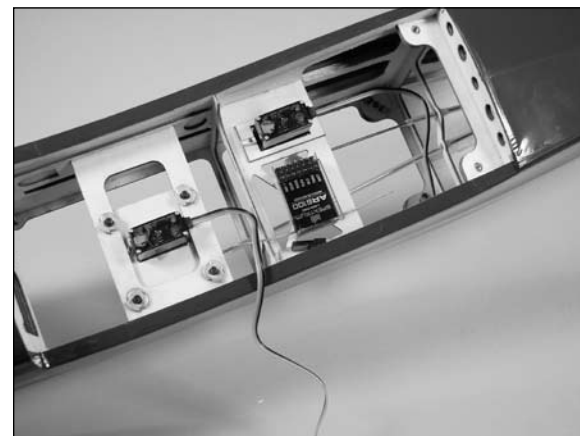

- 4. Plug the rudder and elevator servos into the appropriate ports of the receiver. Tuck the servo leads as necessary so they will not interfere with the operation of the rudder and elevator functions of your aircraft.

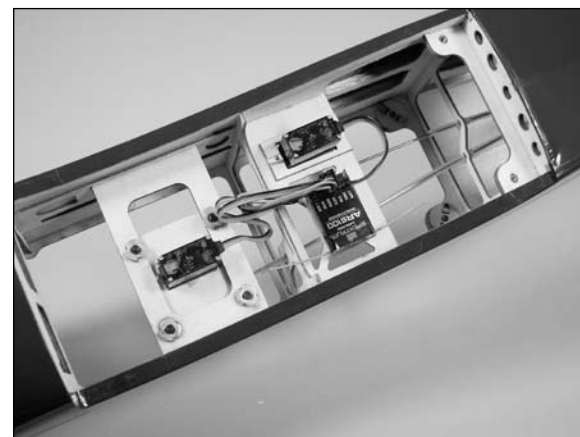

Speed Control Installation, RC/CL Options

Required Parts

Fuselage Assembly Speed control
CL Timer (optional) Hook and loop tape

Required Tools and Adhesives

Scissors

E-tips

We show the installation of the E-flite 30A and 40A Pro SB ESC in the photos. We recommend the 40Amp Lite Pro SB ESC for the Park 480 option. Either 40A ESC can be used. The 40A lite is mounted similar to the 30A ESC.

- 1. Use scissors to cut a piece of hook and loop tape the size of your speed control. Apply one side of the tape to the speed control.

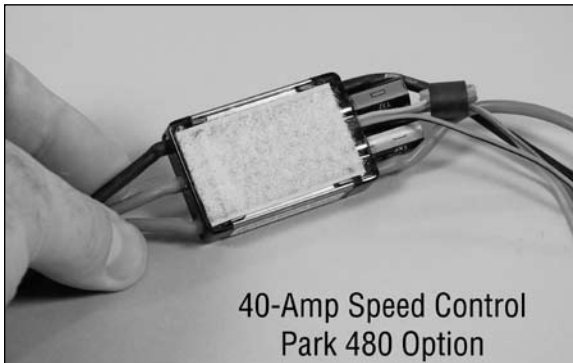

- 2. Apply the remaining side of the hook and loop tape from Step 1 to the inside of the fuselage as shown.

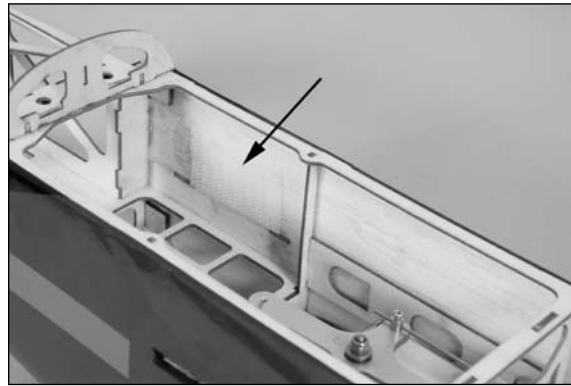

- 3. Attach the speed control to the fuselage using the hook and loop tape.

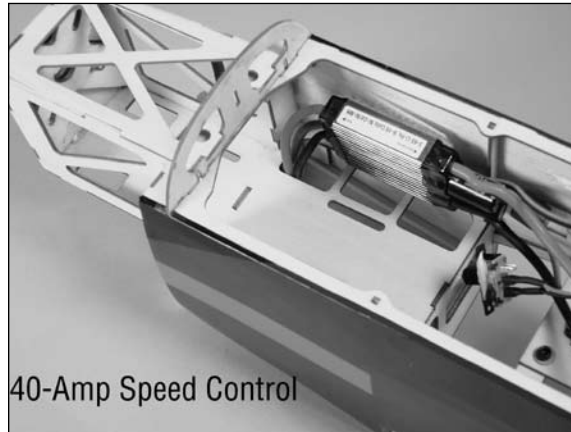

- 4. You will need to plug the lead from the speed control into the receiver for the radio controlled version. Route the lead back and plug it into the throttle port of your receiver. If you are building the control line option you will plug the ESC into the CL Timer (EFLA172). This is shown in step 6 on the next page.



- 5. You will also need to mount the switch for the radio controlled version if using the 40-Amp controller. Use hook and loop material to place it in a convenient location inside the fuselage.

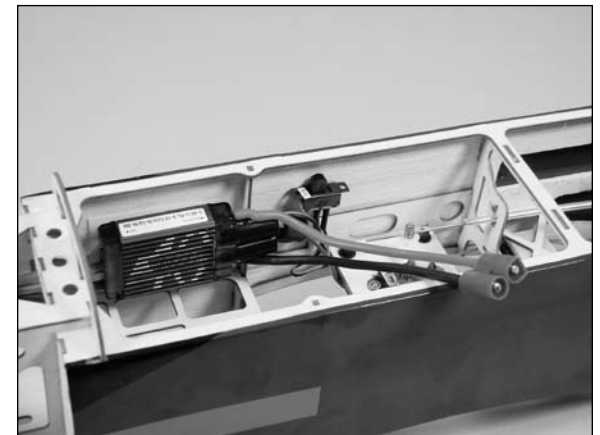

E-tips

Important Information About Your Brushless ESC

Make sure your ESC brake is programmed to Off. Also, be sure to use an ESC with the proper low-voltage cutoff and have it set correctly for the batteries you are using.

- 6. For the control line version, you will need to install the motor timer. Use hook and loop tape to secure it inside the fuselage as shown. Make sure to locate it so it can be adjusted and activated easily.



E-tips

If flying control line it is common to program the ESC brake to On. The PT-19 has been operated in either configuration successfully.

- 7. Route the motor leads from the speed control forward and through the opening in the fuselage as shown.

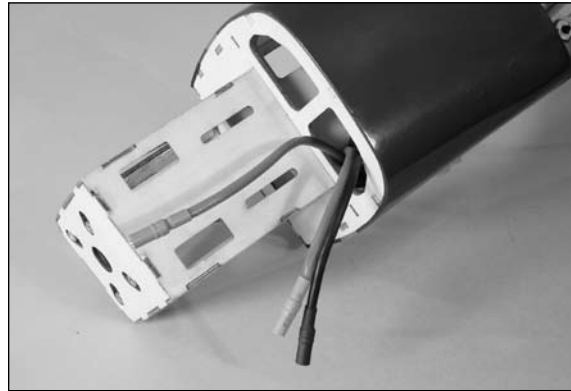

Motor Installation RC/CL Options

Required Parts

Fuselage assembly

#4 washer (4) Motor (Park 450 or 480)

4-40 x 1/2-inch socket head screw (4)

Required Tools and Adhesives

Ball wrench or hex wrench: 3/32-inch

Threadlock Phillips screwdriver: #1

- 1. Attach the X-mount to your motor using the hardware provided with the motor and a #1 Phillips screwdriver. Make sure to use threadlock on the screws to prevent them from vibrating loose.



- 2. Attach your motor to the firewall using four 4-40 x 1/2-inch socket head screws and four #4 washers. Tighten the screws using a 3/32-inch ball driver or hex wrench. Make sure to use threadlock on the four screws to prevent them from vibrating loose.

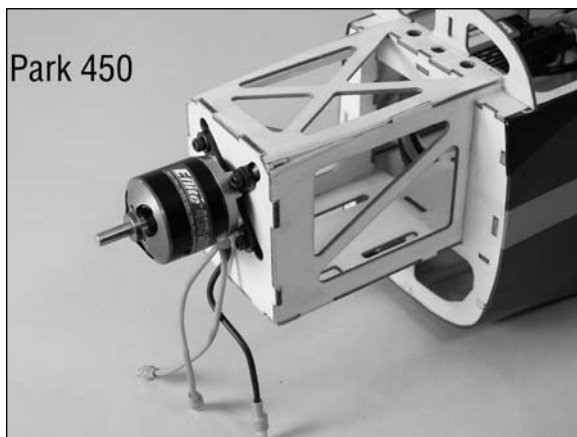
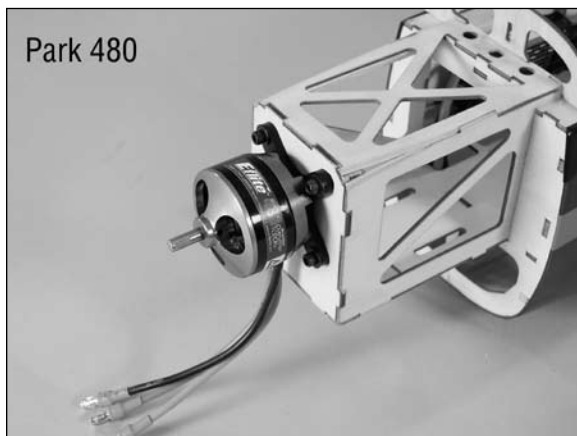

E-tips

The blind nuts in the fuselage for mounting the motor can be positioned for a variety of motors. Position the blind nuts so they are aligned with your particular motor before mounting the motor to the firewall.

- 3. Connect the leads from the motor and speed control at this time.



- 4. Check the operation of the motor at this time. It should rotate counterclockwise when viewed from the front of the aircraft. If not, follow the instructions provided with your speed control to correct the situation.

E-tips

Never check the motor rotation on the bench with the propeller installed. The plane could move and cause serious injury. Always check the motor without the propeller to avoid injury.

Cowling and Propeller Installation, RC/CL Options

Required Parts

Fuselage assembly Cowling
 Propeller adapter Propeller
 2mm x 8mm sheet metal screw(4)

Required Tools and Adhesives

Card stock Low-tack tape
 Scissors Pin drill
 Thin CA Phillips screwdriver: #1
 Drill bit: 1/16-inch (1.5mm), 1/8-inch (3mm)

- 1. Locate the cowl mounting plates inside the fuselage. There are two on each side. These plates reinforce the fuselage where the cowl mounting screws will be positioned.

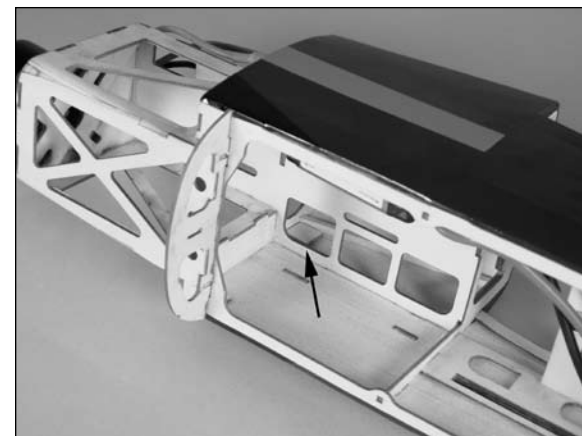

- 2. Cut four strips of card stock that are 3/8-inch (9mm) wide and 4 inches (100mm) long.

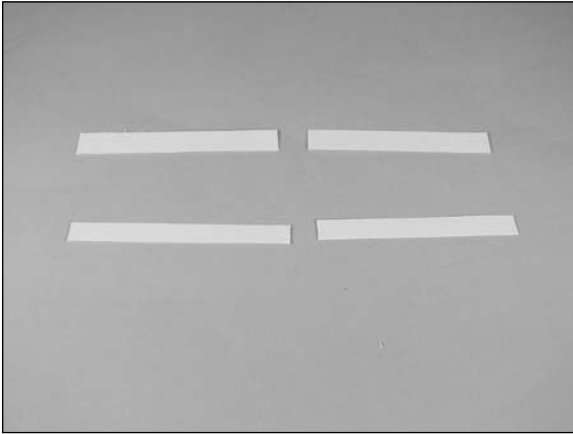

- 3. Use low-tack tape to attach a piece of card stock that will align with the front edge of the fuselage and with the cowl mounting plates that are inside the fuselage.

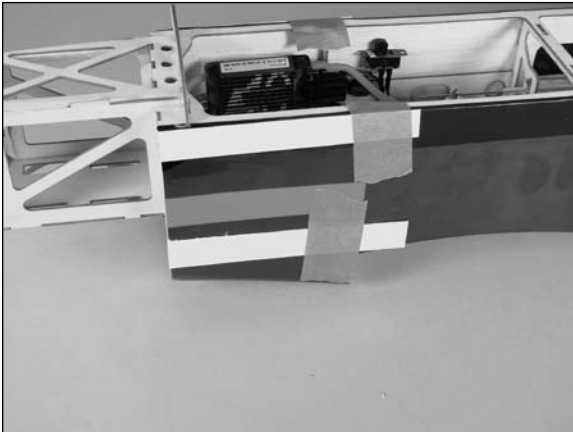

- 4. Place the cockpit hatch back into position on the top of the fuselage.

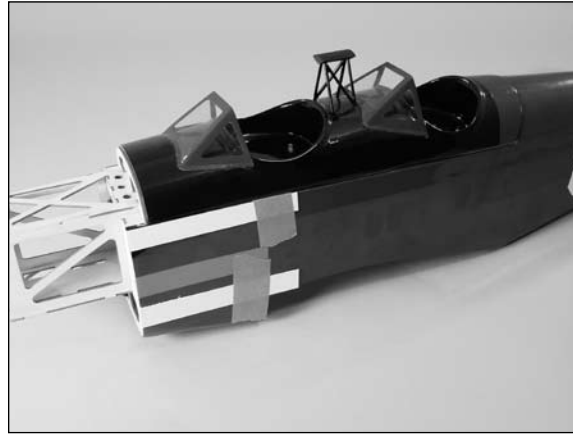

- 5. Slide the cowling onto the front of the fuselage. Make sure the pieces of card stock are positioned on the outside of the cowl.

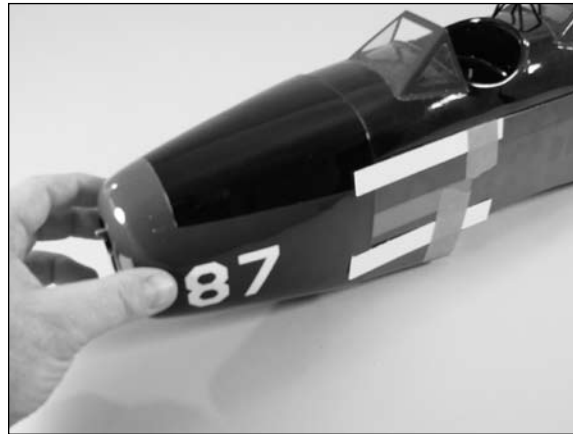

- 6. Slide the propeller adapter onto the motor shaft. Use the adapter to help align the opening in the front of the cowl centered with the adapter and motor shaft.



- 7. Once the opening in the cowl is centered with the adapter, use low-tack tape to hold the cowl in position on the front of the fuselage. Once tape has been applied, check the alignment before continuing to the next step.



- 8. Use a pin drill and 1/16-inch (1.5mm) drill bit to drill the four holes that will be used to secure the cowl with the cowl mounting screws.



- 9. Remove the tape, card stock and cowl from the fuselage. Place 2–3 drops of thin CA into each of the holes to harden the surrounding wood. This will provide a harder surface for the screws to bite into and make them more secure when installed.

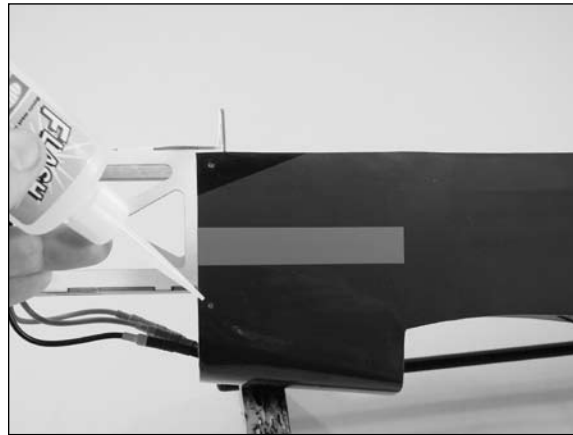

- 10. Use a pin drill and 1/8-inch (3mm) drill bit to enlarge the holes in the cowling.



- 11. Use a #1 Phillips screwdriver and four 2mm x 8mm sheet metal screws to attach the cowl to the fuselage.



E-tips

Important Information About Your Propeller

It is very important to check to be sure the propeller is balanced before installing onto the shaft. An unbalanced propeller may strip the gears or cause poor flight characteristics.

If it is necessary to enlarge the hole in the propeller or the spinner, make sure to check the balance of each afterwards.

- 12. Slide the propeller onto the propeller adapter.



- 13. Thread the adapter nut on the adapter slightly. It does not need to hold the adapter at this time.



- 14. Slide the propeller and adapter onto the motor shaft. Tighten the adapter nut to secure the propeller to the motor shaft.



Motor Battery Placement RC/CL Options

Required Parts

Fuselage assembly Motor battery
Battery strap Hook and loop tape

Required Tools and Adhesives

Scissors

- 1. Locate the battery strap. Pass the strap under the battery tray inside the fuselage as shown.



- 2. Cut a piece of hook and loop material and apply it to the motor battery as shown.



- 3. Place the opposite piece of hook and loop material on the battery tray. This will keep the battery from moving forward or rearward inside the fuselage during flight.



- 4. Position the battery inside the fuselage. Use the battery strap to secure the battery so it does not come loose in flight.



Etips

The position of the battery can be adjusted to the front or rear of the fuselage as necessary to adjust the Center of Gravity when balancing the aircraft for flight.

Wing Installation, RC/CL Options

Required Parts

Fuselage assembly Wing assembly
4-40 x 1-inch socket head bolts (2)
#4 washer (2) Y-harness (RC only)

Required Tools and Adhesives

Ball driver or hex wrench: 3/32-inch

- 1. Plug the Y-harness into the aileron port of the receiver if you are building the radio controlled version of the PT-19.

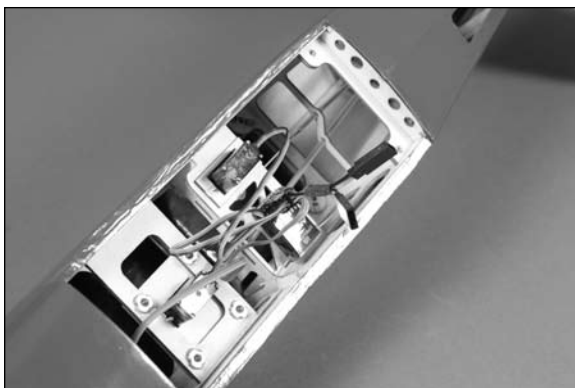

- 2. Plug the leads from the aileron servos into the Y-harness at this time when building the radio controlled version of the PT-19.

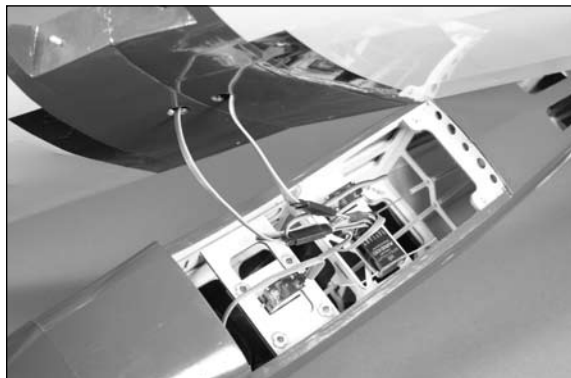

- 3. Position the wing on the fuselage by inserting the dowels at the leading edge of the wing into the notches in the front of the wing saddle of the fuselage. Use a 3/32-inch ball driver or hex wrench to install the two 4-40 x 1-inch socket head bolts and two #4 washers that secure the wing to the fuselage.

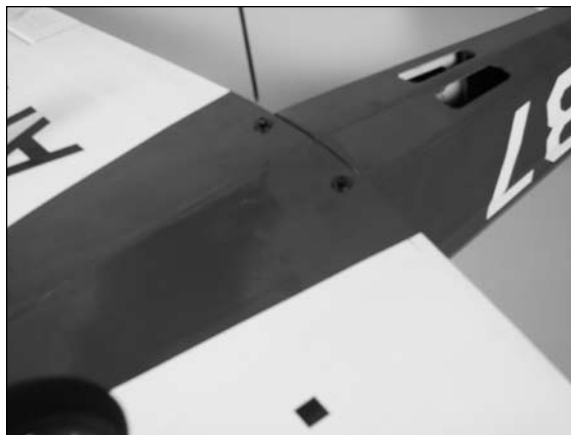

Leadout Guide Installation and Tip Weight Box CL Option

Required Parts

Assembled airframe
#4 washer 4-40 locknut
Sig lead balancing weights, 1/4-ounce (3-4)

Required Tools and Adhesives

Pin drill Drill bit: 1/8-inch (3mm)
Nut driver: 1/4-inch

This section details the installation of the leadout guide and tip weight for the control line version. If you have built the radio controlled version you can skip this section of the manual.

- 1. Use a pin drill and 1/8-inch (3mm) drill bit to drill the hole necessary to accept the threaded stud on the leadout guide.

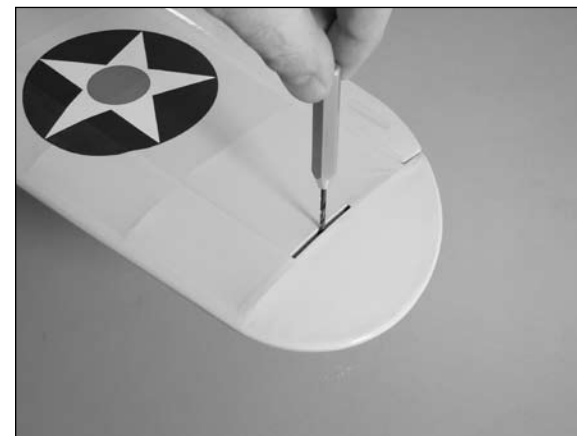

- 2. Insert the leadout guide into the notch in the wing tip as shown.

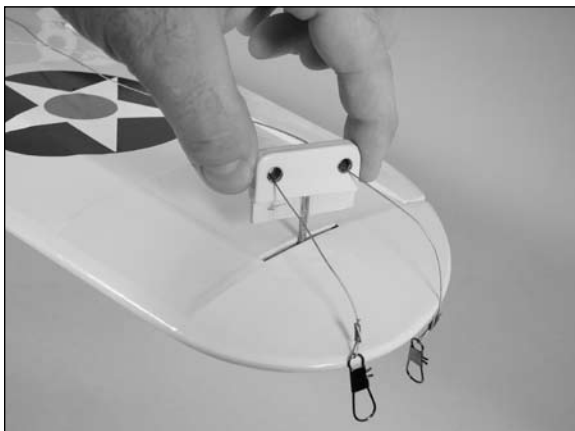

- 3. Check to make sure the leadout wires are not crossed between the fuselage and leadout guide. If so, remove the guide and rotate it so the wires do not cross then insert it back into the slot in the wing tip.



- 4. The leadout guide is attached to the wing using a #4 washer and 4-40 lock nut. Use a 1/4-inch nut driver to tighten the nut. Make sure not to over-tighten the nut and crush the wing structure.



- 5. Use a 3/32 ball driver to open the tip weight box under the right wing tip. Insert 3/4 oz of weight into the box for the first control line flights. We use three Sig lead balancing weights (1/4 oz each) inside the box to laterally balance the model for control line flying.



E-tips

In higher wind conditions you might find that 4 lead weights work better. This is a personal flight preference. For new CL pilots we recommend 4 weights in high wind environments (5–10 mph).

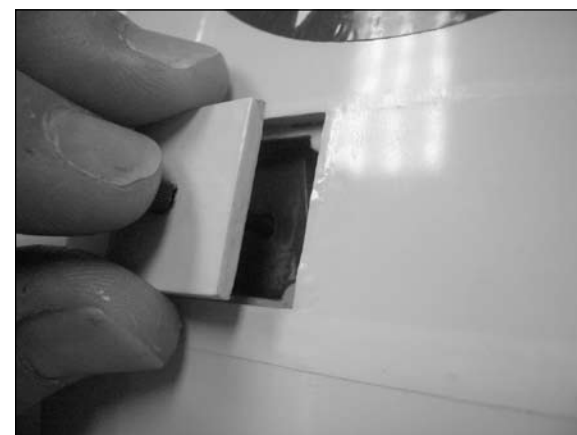
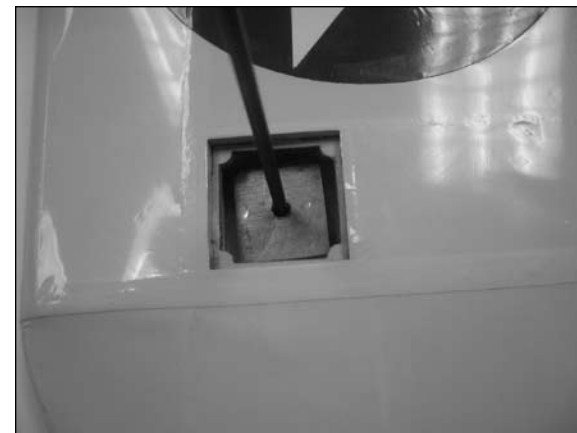

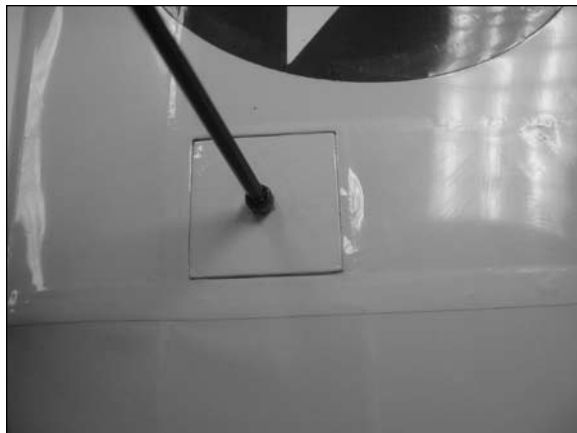

Etips

A small piece of foam rubber inserted after the weights are in place will keep them from rattling in the tip weight box.

Pilot Installation (Optional) RC/CL Options

Required parts

Battery hatch Military pilots (1 or 2)

Tools and adhesives

6-minute epoxy

- 1. If you are planning on installing scale pilots in your PT-19, now would be the best time to do so. They should be installed before balancing your aircraft as they could alter the center of gravity.

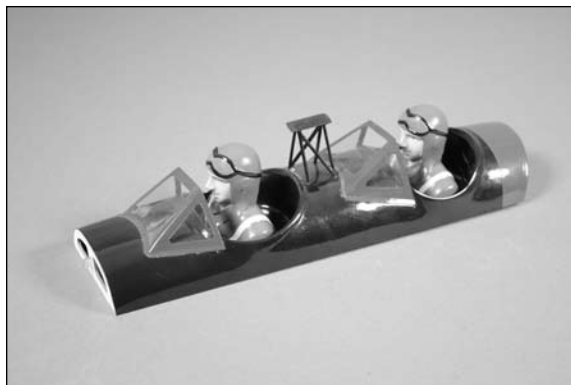

Control Throws

- 1. Turn on the transmitter and receiver of your PT-19 ARF. Check the movement of the rudder using the transmitter. When the stick is moved right, the rudder should also move right. Reverse the direction of the servo at the transmitter if necessary.
- 2. Check the movement of the elevator with the radio system. Moving the elevator stick toward the bottom of the transmitter will make the airplane elevator move up.
- 3. Check the movement of the ailerons with the radio system. Moving the aileron stick right will make the right aileron move up and the left aileron move down.
- 4. Use a ruler to adjust the throw of the elevator, ailerons and rudder. Adjust the position of the pushrod at the control horn to achieve the following measurements when moving the sticks to their endpoints.

Aileron High Rate

Up 1/2-inch (13mm)
Down 1/2-inch (13mm)

Aileron Low Rate

Up 3/8-inch (10mm)
Down 3/8-inch (10mm)

Elevator High Rate

Up 1/2-inch (13mm)
Down 1/2-inch (13mm)

Elevator Low Rate

Up 3/8-inch (10mm)
Down 3/8-inch (10mm)

Rudder High Rate

Up 1-inch (25mm)
Down 1-inch (25mm)

Rudder Low Rate

Up 3/4-inch (19mm)
Down 3/4-inch (19mm)

E-tips

Measurements are taken at the inner or widest point on the control surface.

These are general guidelines measured from our own flight tests. You can experiment with higher rates to match your preferred style of flying.

E-tips

Travel Adjust, Sub Trim and Dual Rates are not listed and should be adjusted according to each individual model and preference.

Center of Gravity

An important part of preparing the aircraft for flight is properly balancing the model.

Caution: Do not inadvertently skip this step!

The recommended Center of Gravity (CG) location for the PT-19 ARF is $2\frac{1}{8}$ to $2\frac{3}{8}$ inches (54 to 60mm) back from the leading edge of the wing. Mark the location for the Center of Gravity on the top of the wing next to the fuselage as shown.

When balancing your PT-19 ARF, support the plane inverted at the marks made on the top of the wing with your fingers or a commercially available balancing stand. Adjust components as necessary so the model hangs level or slightly nose down. This is the correct balance point for your model. You might find you may be required to add a small amount of weight to either the front or back of the fuselage to achieve the correct balance.

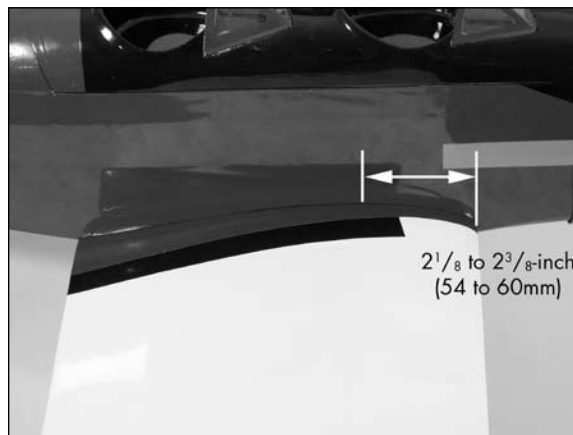

After the first flights, the CG position can be adjusted for your personal preference.

Preflight

Check Your Radio

Before going to the field, be sure that your batteries are fully charged per the instructions included with your radio. Charge both the transmitter and receiver pack for your airplane. Use the recommended charger supplied with your particular radio system, following the instructions provided with the radio. In most cases, the radio should be charged the night before going out flying.

Before each flying session, be sure to range check your radio. See your radio manual for the recommended range and instructions for your radio system. Each radio manufacturer specifies different procedures for their radio systems. Next, start the motor. With the model securely anchored, check the range again. The range test should not be significantly affected. If it is, don't attempt to fly! Have your radio equipment checked out by the manufacturer.

E-tips

Keep loose items that can get entangled in the propeller away from the prop. These include loose clothing, or other objects such as pencils and screwdrivers. Especially keep your hands away from the propeller.

Double-check that all controls (aileron, elevator, rudder and throttle) move in the correct direction.

Check the radio installation and make sure all the control surfaces are moving correctly (i.e. the correct direction and with the recommended throws). Test run the motor and make sure it transitions smoothly from off to full throttle and back. Also ensure the engine is installed according to the manufacturer's instructions, and it will operate consistently.

Check all the control horns, servo horns, and clevises to make sure they are secure and in good condition. Replace any items that would be considered questionable. Failure of any of these components in flight would mean the loss of your aircraft.

Range Test Your Radio

- 1. Before each flying session, be sure to range check your radio. This is accomplished by turning on your transmitter with the antenna collapsed. Turn on the receiver in your airplane. With your airplane on the ground and the engine running, you should be able to walk 30 paces (approximately 100 feet) away from your airplane and still have complete control of all functions.

If not, don't attempt to fly! Have your radio equipment checked out by the manufacturer.

- 2. Double-check that all controls (aileron, elevator, rudder and throttle) move in the correct direction.
- 3. Be sure that your transmitter batteries are fully charged, per the instructions included with your radio.

Control Line Flying Checklist

If you are planning to fly your PT-19 as a control line model you will need to accomplish a few items first to help ensure success during the first flight. With the model having the ability to be built in two different ways, Radio Control or Control Line, we have two sections dedicated to help you prepare the model.

CONTROL LINE BUILT MODEL

If you have constructed your model with the sole intent of flying it as a control line model, you need only add tip weight for flight.

Be sure to place 3/4-ounce of tip weight in the tip weight box located under the right wing tip. This will help hold the model level and counter the weight of the lines. We use Sig 1/4 ounce tip weights (SIGSH561). These weights are available at your local hobby shop. You may vary the amount of weight at your discretion to fine-tune the flight qualities of your PT-19.

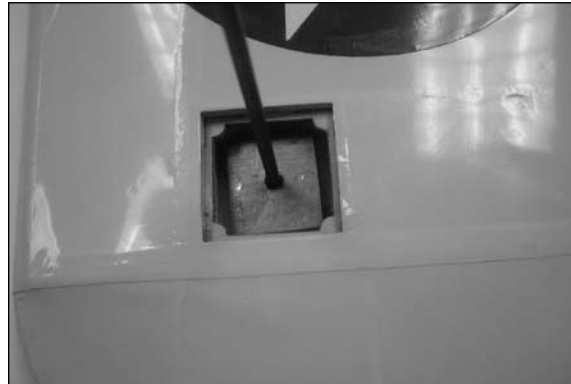

RADIO CONTROL BUILT MODEL

If you have constructed your model with the main intent of RC flying, you can convert your model over to Control Line flying in just a few short minutes. You will need to lock the ailerons, set the rudder offset, add the tip weights, and swap out the elevator control system. To set the ailerons to a neutral position all that is needed is a small piece of clear tape placed over the trailing edge covering both the top and bottom of the aileron. This will lock them in place and prepare the ailerons for you.

Note: Colored tape was used in the photos so it could be seen. Please use clear tape on your model.

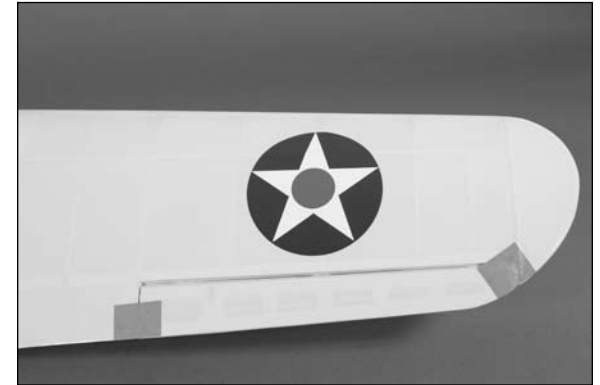

You will need to set the rudder offset next. This is done by placing a piece of tape on each side of the rudder/vertical fin joint as shown in the photo below. Be sure to tape the rudder with an offset to the right to help pull the model outboard of the circle being flown. The model will fly in a counterclockwise rotation and needs right rudder for the offset. The amount of offset is not extremely critical for the PT-19. Measuring at approximately 3/8–1/2 inch of right offset will deliver a nice strong pull during flight without any bad tendencies during basic maneuvering.

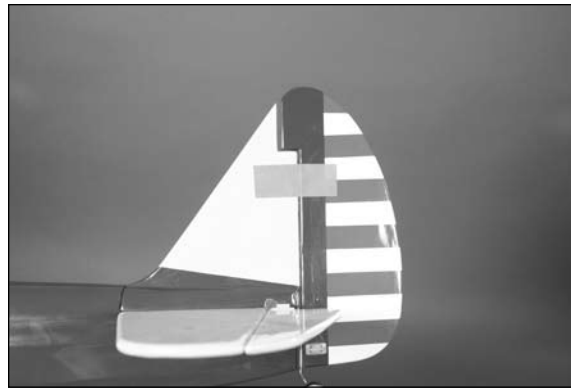
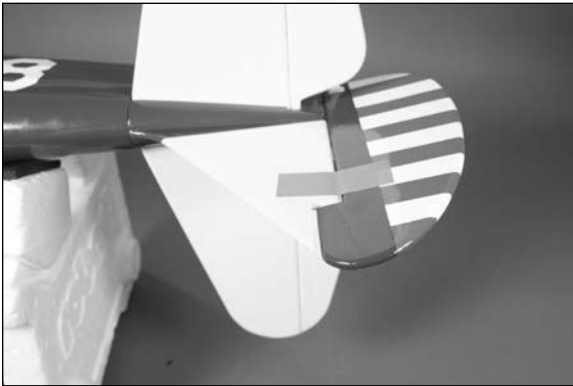
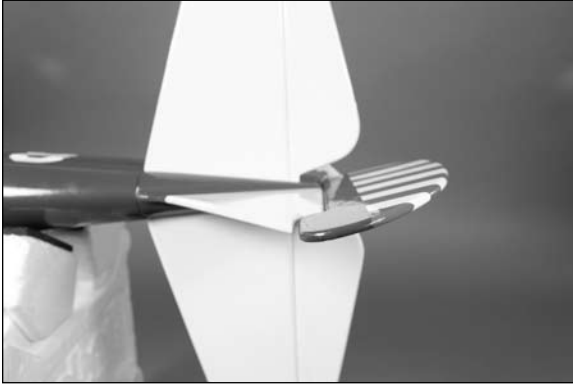

Be sure to place 3/4-ounce of tip weight in the tip weight box located under the right wing tip. This will help hold the model level and counter the balance effects of the lines. We use Sig 1/4-ounce tip weights (SIGSH561). These weights are available at your local hobby shop. You may vary the amount of weight at your discretion to fine-tune the flight qualities of your PT-19.

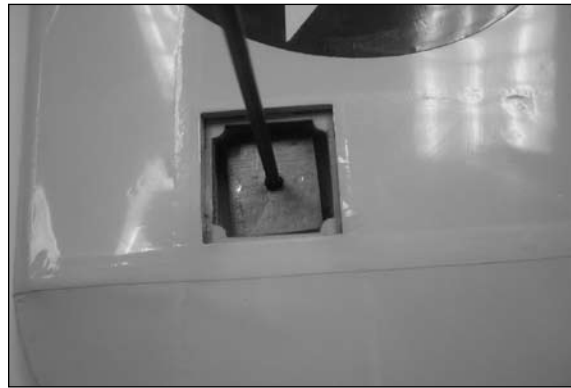

Finally, you will need to do the installation of the bellcrank and leadouts as described in the manual on pages 18 and 29. Once this has been accomplished you need only remove the four 4-40 bolts and insert the servo tray back in place after flying. Please follow the steps in the section titled "Leadout Guide Installation and Tip Weight Box CL Option" beginning on page 29 of the manual.

MOTOR SELECTION

There are two motor selections for your PT-19: the Park 450 and Park 480 outrunner motors. The PT-19 will fly on either motor when being flown using the control line option. Please note the following:

Park 450: When flying your PT-19 using the Power 450 motor, ensure the winds are light (less than 5mph) and limit your aerobatic maneuvers to basic loops, climbing and diving.

Park 480: When flying your PT-19 using the Park 480 motor, ensure winds are light (less than 5mph) and you can perform the basic aerobatic maneuvers without any problems: loops, inverted flight, wing overs, lazy eights, square loops, etc. The PT-19 was not designed to fly the entire AMA pattern of maneuvers, but can provide many hours of enjoyable control line flying.

CONTROL LINE FLYING AT THE FIELD

Once you have the model set up and are ready to fly, we will want to double check a few items before taking to the air. Follow this simple checklist before your first flight to ensure everything is correct.

1. Ailerons locked in position
2. Rudder locked in position
3. Tip weight installed
4. Control line connectors secure
5. Handle connectors secure

Now we will need to ensure our flying area is clear of any obstructions. The lines used are 52 feet long. You will need a clear circle of 125 feet in diameter for flying the PT-19. Keep in mind that onlookers may come to watch and ensure you have a helper to keep the circle clear during flight. The PT-19 has been designed to deliver nice smooth control line flight with some very basic aerobatic abilities. The model is capable of wing-overs, loops (both inside and outside), inverted flight, and lazy eights. Other maneuvers may be possible but understand the PT-19 is not designed as a serious stunt machine. You will find the takeoffs to be easy and quick as well as the basic flight performance. Landings are easily guided down as well. Please note the diagrams showing wing direction and placement for takeoff and maneuvering as the wind plays a major part in line tension during these maneuvers.

MANEUVERING

Just for refreshers, we want to demonstrate the correct control technique for control line flying. You will want to hold the handle straight out from your body and give control input by moving your arm up and down. Very slight wrist movements will come into play, but the major control part is by full arm movement. To fly level keep your arm straight and horizontal.

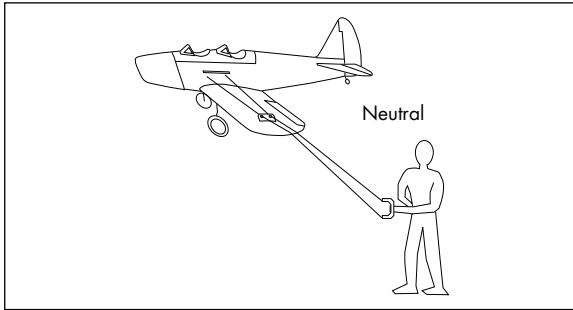

To climb, move your arm upward which will cause the elevator to give an up command to the model.

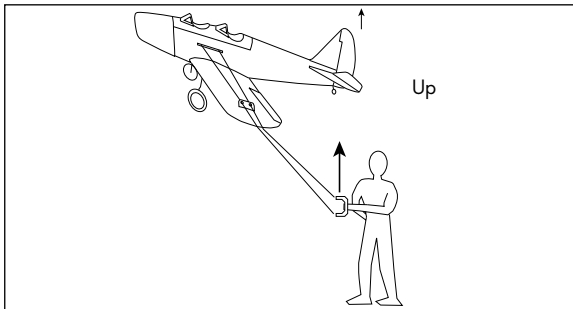

To descend, move your arm downward which will cause the elevator to give a down command to the model.

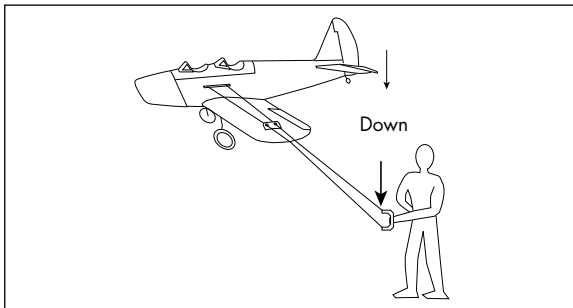

TAKEOFF

With your helper holding the model and the battery hatch removed, position the plane where the wind is at the tail of the model for takeoff. Plug the battery in and wait for the speed control to initialize. Once complete, have your helper/holder push the button down on the timer to set the run time for the flight. Once set, your helper will install the hatch and you are ready for takeoff. Have your helper hold the model with the nose pointed slightly outside of the circle. The pilot should be ready to step back to maintain line tension immediately following release. Once the model is rolling along, apply a small amount of up elevator to have the model rise from the ground. Once in the air, level off at an altitude of 6–15 feet above the ground. As you fly, try some simple up and down commands to get used to your PT-19.

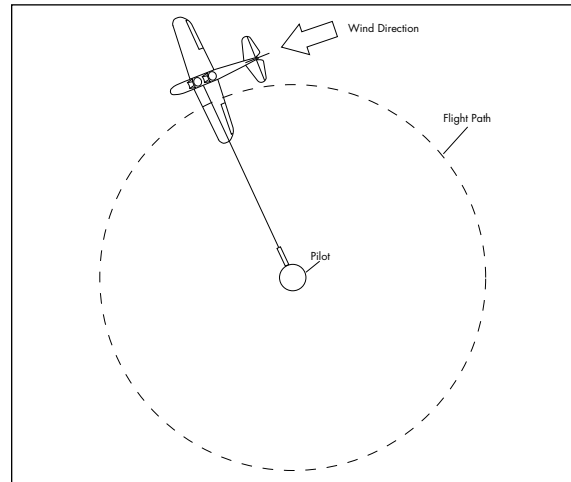

FLYING

During the flight you may wish to perform some basic aerobatic maneuvers. Using a combination of your straight arm technique as described earlier and very small wrist movements, you can begin your maneuvers. Practice and try one maneuver at a time. Ensure you place all maneuvers with the wind at your back to maintain line tension. If during any time of the flight you notice a decrease in pull from the model, this is an indication of reduced line tension and the pilot must step back immediately to regain tension. Failure to do so may cause you to lose control of your model possibly resulting in a crash and damage to the model.

LANDING

When the timer is at the end of the flight cycle it will cycle power very quickly to let you know you have less than 20 seconds until it shuts down. Once this occurs, you will want to position the aircraft to a level flight position approximately 6–10 feet above the ground. As the motor slows down, gradually descend to touchdown. Keep in mind the line tension is very important during this phase of flight. If the model is flying into the wind (or with the wind in your face) you may need to step back quickly to maintain line tension until touchdown. Once you have landed, have your helper pick up the model and take it back to your takeoff spot. During this time, try to keep the lines taut so not to snag them on the ground and cause any kinks which could fail at a later time. Unplug the battery and you have completed your flight.

This is where it all started over 75 years ago in the world of model aviation. If you grew up with a blue and yellow PT-19 as most of us did, we believe this model should help you relive some of those great memories of yesteryear. We hope you enjoy the PT-19 in both Radio Control and Control Line format as much as we do.

Happy flying!

FIRST FLIGHTS

Remember, it does not take large movements to fly a control line airplane. For the first couple of flights, concentrate on keeping your wrist and forearm locked into a position and move your hand up and down at the elbow. This will provide the needed amount of control movement while stabilizing the airplane and leading to a very successful flight. If you start by moving your wrist up and down, the airplane will respond very rapidly and it could result in damage. Take your time and relearn the skills you used to have ... and you'll have a blast again!

Safety, Precautions and Warnings

As the user of this product, you are solely responsible for operating it in a manner that does not endanger yourself and others or result in damage to the product or the property of others.

Carefully follow the directions and warnings for this and any optional support equipment (chargers, rechargeable battery packs, etc.) that you use. This model is controlled by a radio signal that is subject to interference from many sources outside your control. This interference can cause momentary loss of control so it is necessary to always keep a safe distance in all directions around your model, as this margin will help to avoid collisions or injury.

- Always operate your model in an open area away from cars, traffic or people.
- Avoid operating your model in the street where injury or damage can occur.
- Never operate the model out into the street or populated areas for any reason.
- Never operate your model with low transmitter batteries.
- Carefully follow the directions and warnings for this and any optional support equipment (chargers, rechargeable battery packs, etc.) that you use.
- Keep all chemicals, small parts and anything electrical out of the reach of children.
- Moisture causes damage to electronics. Avoid water exposure to all equipment not specifically designed and protected for this purpose.

Safety Do's and Don'ts for Pilots

- Check all control surfaces prior to each takeoff.
- Do not fly your model near spectators, parking areas or any other area that could result in injury to people or damage of property.
- Do not fly during adverse weather conditions. Poor visibility can cause disorientation and loss of control of your aircraft. Strong winds can cause similar problems.
- Do not take chances. If at any time during flight you observe any erratic or abnormal operation, land immediately and do not resume flight until the cause of the problem has been ascertained and corrected. Safety can never be taken lightly.
- Do not fly near power lines.

Warranty Information

WARRANTY PERIOD

Horizon Hobby, Inc., (Horizon) warrants that the Products purchased (the "Product") will be free from defects in materials and workmanship at the date of purchase by the Purchaser.

LIMITED WARRANTY

(a) This warranty is limited to the original Purchaser ("Purchaser") and is not transferable. REPAIR OR REPLACEMENT AS PROVIDED UNDER THIS WARRANTY IS THE EXCLUSIVE REMEDY OF THE PURCHASER. This warranty covers only those Products purchased from an authorized Horizon dealer. Third party transactions are not covered by this warranty. Proof of purchase is required for warranty claims. Further, Horizon reserves the right to change or modify this warranty without notice and disclaims all other warranties, express or implied.

(b) Limitations- HORIZON MAKES NO WARRANTY OR REPRESENTATION, EXPRESS OR IMPLIED, ABOUT NON-INFRINGEMENT, MERCHANTABILITY OR FITNESS FOR A PARTICULAR PURPOSE OF THE PRODUCT. THE PURCHASER ACKNOWLEDGES THAT THEY ALONE HAVE DETERMINED THAT THE PRODUCT WILL SUITABLY MEET THE REQUIREMENTS OF THE PURCHASER'S INTENDED USE.

(c) Purchaser Remedy- Horizon's sole obligation hereunder shall be that Horizon will, at its option, (i) repair or (ii) replace, any Product determined by Horizon to be defective. In the event of a defect, these are the Purchaser's exclusive remedies. Horizon reserves the right to inspect any and all equipment involved in a warranty claim. Repair or replacement decisions are at the sole discretion of Horizon. This warranty does not cover cosmetic damage or damage due to acts of God, accident, misuse, abuse, negligence, commercial use, or modification of or to any part of the Product. This warranty does not cover damage due to improper installation, operation, maintenance, or attempted repair by anyone other than Horizon. Return of any goods by Purchaser must be approved in writing by Horizon before shipment.

DAMAGE LIMITS

HORIZON SHALL NOT BE LIABLE FOR SPECIAL, INDIRECT OR CONSEQUENTIAL DAMAGES, LOSS OF PROFITS OR PRODUCTION OR COMMERCIAL LOSS IN ANY WAY CONNECTED WITH THE PRODUCT, WHETHER SUCH CLAIM IS BASED IN CONTRACT, WARRANTY, NEGLIGENCE, OR STRICT LIABILITY. Further, in no event shall the liability of Horizon exceed the individual price of the Product on which liability is asserted. As Horizon has no control over use, setup, final assembly, modification or misuse, no liability shall be assumed nor accepted for any resulting damage or injury. By the act of use, setup or assembly, the user accepts all resulting liability. If you as the Purchaser or user are not prepared to accept the liability associated with the use of this Product, you are advised to return this Product immediately in new and unused condition to the place of purchase.

Law: These Terms are governed by Illinois law (without regard to conflict of law principals).

SAFETY PRECAUTIONS

This is a sophisticated hobby Product and not a toy. It must be operated with caution and common sense and requires some basic mechanical ability. Failure to operate this Product in a safe and responsible manner could result in injury or damage to the Product or other property. This Product is not intended for use by children without direct adult supervision. The Product manual contains instructions for safety, operation and maintenance. It is essential to read and follow all the instructions and warnings in the manual, prior to assembly, setup or use, in order to operate correctly and avoid damage or injury.

QUESTIONS, ASSISTANCE, AND REPAIRS

Your local hobby store and/or place of purchase cannot provide warranty support or repair. Once assembly, setup or use of the Product has been started, you must contact Horizon directly. This will enable Horizon to better answer your questions and service you in the event that you may need any assistance. For questions or assistance, please direct your email to productsupport@horizonhobby.com, or call 877.504.0233 toll free to speak to a service technician.

INSPECTION OR REPAIRS

If this Product needs to be inspected or repaired, please call for a Return Merchandise Authorization (RMA). Pack the Product securely using a shipping carton. Please note that original boxes may be included, but are not designed to withstand the rigors of shipping without additional protection. Ship via a carrier that provides tracking and insurance for lost or damaged parcels, as **Horizon is not responsible for merchandise until it arrives and is accepted at our facility**. A Service Repair Request is available at www.horizonhobby.com on the "Support" tab. If you do not have internet access, please include a letter with your complete name, street address, email address and phone number where you can be reached during business days, your RMA number, a list of the included items, method of payment for any non-warranty expenses and a brief summary of the problem. Your original sales receipt must also be included for warranty consideration. Be sure your name, address, and RMA number are clearly written on the outside of the shipping carton.

WARRANTY INSPECTION AND REPAIRS

To receive warranty service, you must include your original sales receipt verifying the proof-of-purchase date. Provided warranty conditions have been met, your Product will be repaired or replaced free of charge. Repair or replacement decisions are at the sole discretion of Horizon Hobby.

NON-WARRANTY REPAIRS

Should your repair not be covered by warranty the repair will be completed and payment will be required without notification or estimate of the expense unless the expense exceeds 50% of the retail purchase cost. By submitting the item for repair you are agreeing to payment of the repair without notification. Repair estimates are available upon request. You must include this request with your repair. Non-warranty repair estimates will be billed a minimum of ½ hour of labor. In addition you will be billed for return freight. Please advise us of your preferred method of payment. Horizon accepts money orders and cashiers checks, as well as Visa, MasterCard, American Express, and Discover cards. If you choose to pay by credit card, please include your credit card number and expiration date. Any

repair left unpaid or unclaimed after 90 days will be considered abandoned and will be disposed of accordingly. **Please note: non-warranty repair is only available on electronics and model engines.**

Electronics and engines requiring inspection or repair should be shipped to the following address:

Horizon Service Center
4105 Fieldstone Road
Champaign, Illinois 61822

or

Horizon Hobby UK
Units 1-4, Ployters Road
Staple Tye
Harlow, Essex
CM187NS
United Kingdom

or

Horizon Technischer Service
Otto-Hahn-Str. 9a
25337 Elmshorn
Germany

USA: Please call 1 877 504 0233 or visit horizonhobby.com to find our distributor for your country for support with any questions or concerns regarding this product or warranty.

UK: Please call +44 (0) 1279 641 097 or email sales@horizonhobby.co.uk with any questions or concerns regarding this product or warranty.

Germany: Please call +49 4121 46199 66 or email service@horizonhobby.de with any questions or concerns regarding this product or warranty.

Instructions for Disposal of WEEE by Users in the European Union

This product must not be disposed of with other waste. Instead, it is the user's responsibility to dispose of their waste equipment by handing it over to a designated collection point for the recycling of waste electrical and electronic equipment. The separate collection and recycling of your waste equipment at the time of disposal will help to conserve natural resources and ensure that it is recycled in a manner that protects human health and the environment. For more information about where you can drop off your waste equipment for recycling, please contact your local city office, your household waste disposal service or where you purchased the product.

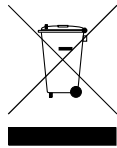

2008 Official Academy of Model Aeronautics Safety Code

GENERAL

1. A model aircraft shall be defined as a non-human-carrying device capable of sustained flight in the atmosphere. It shall not exceed limitations established in this code and is intended to be used exclusively for recreational or competition activity.
2. The maximum takeoff weight of a model aircraft, including fuel, is 55 pounds, except for those flown under the AMA Experimental Aircraft Rules.
3. I will abide by this Safety Code and all rules established for the flying site I use. I will not willfully fly my model aircraft in a reckless and/or dangerous manner.
4. I will not fly my model aircraft in sanctioned events, air shows, or model demonstrations until it has been proven airworthy.
5. I will not fly my model aircraft higher than approximately 400 feet above ground level, when within three (3) miles of an airport without notifying the airport operator. I will yield the right-of-way and avoid flying in the proximity of full-scale aircraft, utilizing a spotter when appropriate.
6. I will not fly my model aircraft unless it is identified with my name and address, or AMA number, inside or affixed to the outside of the model aircraft. This does not apply to model aircraft flown indoors.
7. I will not operate model aircraft with metal-blade propellers or with gaseous boosts (other than air), nor will I operate model aircraft with fuels containing tetranitromethane or hydrazine.

8. I will not operate model aircraft carrying pyrotechnic devices which explode burn, or propel a projectile of any kind. Exceptions include Free Flight fuses or devices that burn producing smoke and are securely attached to the model aircraft during flight. Rocket motors up to a G-series size may be used, provided they remain firmly attached to the model aircraft during flight. Model rockets may be flown in accordance with the National Model Rocketry Safety Code; however, they may not be launched from model aircraft. Officially designated AMA Air Show Teams (AST) are authorized to use devices and practices as defined within the Air Show Advisory Committee Document.
9. I will not operate my model aircraft while under the influence of alcohol or within eight (8) hours of having consumed alcohol.
10. I will not operate my model aircraft while using any drug which could adversely affect my ability to safely control my model aircraft.
11. Children under six (6) years old are only allowed on a flightline or in a flight area as a pilot or while under flight instruction.
12. When and where required by rule, helmets must be properly worn and fastened. They must be OSHA, DOT, ANSI, SNELL or NOCSAE approved or comply with comparable standards.

RADIO CONTROL

1. All model flying shall be conducted in a manner to avoid over flight of unprotected people.
2. I will have completed a successful radio equipment ground-range check before the first flight of a new or repaired model aircraft.
3. I will not fly my model aircraft in the presence of spectators until I become a proficient flier, unless I am assisted by an experienced pilot.
4. At all flying sites a line must be established, in front of which all flying takes place. Only personnel associated with flying the model aircraft are allowed at or in front of the line. In the case of airshows demonstrations straight line must be established. An area away from the line must be maintained for spectators. Intentional flying behind the line is prohibited.

5. I will operate my model aircraft using only radio-control frequencies currently allowed by the Federal Communications Commission (FCC). Only individuals properly licensed by the FCC are authorized to operate equipment on Amateur Band frequencies.
6. I will not knowingly operate my model aircraft within three (3) miles of any preexisting flying site without a frequency-management agreement. A frequency-management agreement may be an allocation of frequencies for each site, a day-use agreement between sites, or testing which determines that no interference exists. A frequency-management agreement may exist between two or more AMA chartered clubs, AMA clubs and individual AMA members, or individual AMA members. Frequency-management agreements, including an interference test report if the agreement indicates no interference exists, will be signed by all parties and copies provided to AMA Headquarters.
7. With the exception of events flown under official AMA rules, no powered model may be flown outdoors closer than 25 feet to any individual, except for the pilot and located at the flightline.
8. Under no circumstances may a pilot or other person touch a model aircraft in flight while it is still under power, except to divert it from striking an individual.
9. Radio-controlled night flying is limited to low-performance model aircraft (less than 100 mph). The model aircraft must be equipped with a lighting system which clearly defines the aircraft's attitude and direction at all times.
10. The operator of a radio-controlled model aircraft shall control it during the entire flight, maintaining visual contact without enhancement other than by corrective lenses that are prescribed for the pilot. No model aircraft shall be equipped with devices which allow it to be flown to a selected location which is beyond the visual range of the pilot.

PARK FLYER SAFE OPERATING RECOMMENDATIONS

- Inspect your model before every flight to make certain it is airworthy.
- Be aware of any other radio frequency user who may present an interference problem.
- Always be courteous and respectful of other users of your selected flight area.
- Choose an area clear of obstacles and large enough to safely accommodate your flying activity.
- Make certain this area is clear of friends and spectators prior to launching your aircraft.
- Be aware of other activities in the vicinity of your flight path that could cause potential conflict.
- Carefully plan your flight path prior to launch.
- Abide by any and all established AMA National Model Aircraft Safety Code.

CONTROL LINE

1. I will subject my complete control system (including the safety thong where applicable) to an inspection and pull test prior to flying. The pull test will be in accordance with the current Competition Regulations for the applicable model aircraft category. Model aircraft not fitting a specific category shall use those pull-test requirements as indicated for Control Line Precision Aerobatics.
2. I will ensure that the flying area for the model is clear of all utility wires or poles and I will not fly a model aircraft closer than 50 feet to any above-ground electric utility lines.
3. I will ensure that the flying area for the model is clear of all nonessential participants and spectators before permitting its engine to be started.



© 2009 Horizon Hobby, Inc.
4105 Fieldstone Road
Champaign, Illinois 61822
(877) 504-0233
horizonhobby.com
E-fliteRC.com