

# Ultimate 20-300 10 ARF

Assembly Manual



## Specifications

Wingspan:	38 in (960mm)
Length:	41 in (1045mm)
Wing Area:	473.5 sq in (30.5 sq dm)
Weight w/o Battery:	34-36 oz (965-1020 g)
Weight w/Battery:	39-41 oz (1105-1160 g)



## Table of Contents

---

Introduction.....	2
Using the Manual.....	2
Contents of Kit/Parts Layout.....	3
Covering Colors.....	3
Required Radio Equipment.....	3
Required Tools and Adhesives.....	4
Important Information About Motor Selection.....	4
Brushless Outrunner Setup.....	4
Optional Accessories.....	4
Notes Regarding Servos and ESC.....	4
Note on Lithium Polymer Batteries.....	4
Warning.....	4
Warranty Information.....	5
Safety, Precautions, and Warnings.....	7
Hinging the Ailerons.....	7
Aileron Servo Installation.....	10
Stabilizer Installation.....	15
Hinging the Rudder and Stabilizer.....	19
Rudder and Elevator Servo Installation.....	22
Receiver and Landing Gear Installation.....	24
Motor and Cowling Installation.....	25
Upper Wing and Canopy Installation.....	29
Control Throws.....	32
Final Control Throws.....	34
Center of Gravity.....	35
Preflight.....	35
Range Test Your Radio.....	36
Flying Your Ultimate 20-300.....	36
Instructions for Disposal of WEEE by Users in the European Union.....	36
2008 Official AMA National Model Aircraft Safety Code ...	37
Building and Flying Notes.....	38

## Introduction

---

E-flite's Ultimate 20-300 10 ARF is a sport replica of the rare two-place aerobatic aircraft. The large wing area and light wing loading of its biplane design provide smooth flight characteristics and precise response. The Ultimate is designed around E-flite's Power 10, which provides excellent power for any aerobatic maneuver. The Ultimate's features include: UltraCote® and UltraCote Lite covering, steerable tail wheel, authentic Ultimate style spinner, fiberglass cowl and wheel pants, plastic molded wing fillets, and a lightweight balsa and plywood frame. The features and level of prefabrication of the Ultimate allows the modelers to have the ability to fly this incredible biplane in less time than similar models.

Intermediate pilots will enjoy the ability to grow their skills rapidly with the Ultimate, while advanced pilots will enjoy maximum performance with no extra effort.

## Using the Manual

---

This manual is divided into sections to help make assembly easier to understand, and to provide breaks between each major section. In addition, check boxes have been placed next to each step to keep track of each step completed. Steps with a single circle (○) are performed once, while steps with two circles (○ ○) indicate that the step will require repeating, such as for a right or left wing panel, two servos, etc.

Remember to take your time and follow the directions.

## Contents of Kit/Parts Layout

### Replacement Parts

EFL2751	Fuselage
EFL2752	Top Wing w/Ailerons, Left and Right
EFL2753	Bottom Wing w/Ailerons, Left and Right
EFL2754	Tail Set
EFL2755	Outer Wing Struts
EFL2756	Cowl
EFL2757	Canopy
EFL2758	Spinner
EFL2759	Landing Gear
EFL2760	Wheel Pants
EFL2761	Axles
EFL2762	Wheels
EFL2763	Hardware Set
EFL2764	Pushrod Set

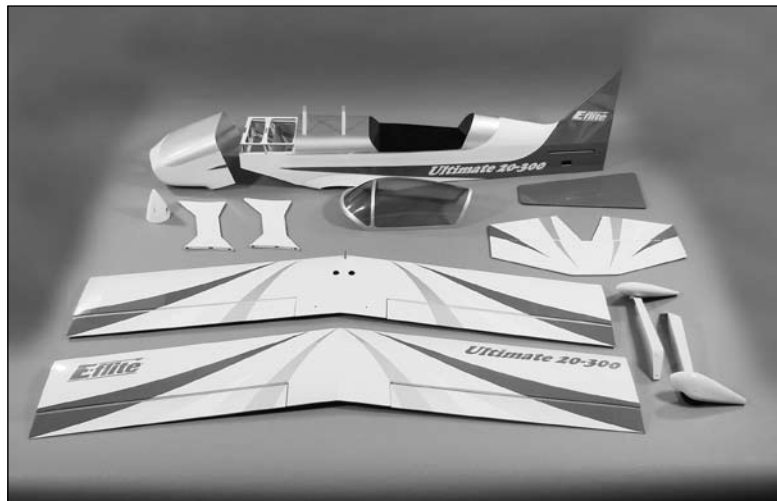

## Covering Colors

Scale White	HANU973
Deep Blue	HANU873
Silver	HANU881
Bright Yellow	HANU872

## Required Radio Equipment

You will need a minimum 5-channel transmitter, receiver, and four sub-micro servos. You can choose to purchase a complete radio system. If you are using an existing transmitter, just purchase the other required equipment separately. We recommend the crystal-free, interference-free Spektrum™ DX6i 2.4GHz DSM® 6-channel system. If using your own transmitter, we recommend the Spektrum 7.5-gram Super Sub-Micro Digital Programmable Servos. When using the Spektrum DS75 servos with the Ultimate 20-300 you must use the Spektrum Digital Servo Programmer (SPMDSP). This will allow you to get the proper travel, resolution and geometry.

If you own the Spektrum DX6i radio, just add the AR6200 DSM2™ 6-channel receiver and four of our Spektrum 7.5-gram Super Sub-Micro Digital Programmable Servos.

### Complete Radio System

SPM6600                      DX6i DSM 6CH system

### Or Purchase Separately

SPMAR6200                      AR6200 DSM2 6-Channel Receiver Ultralite  
(for DX6i or DX7)

### And

SPMDSP                      Spektrum Digital Servo Programmer  
SPMDSP75                      7.5-gram Super Sub-Micro Digital  
   Programmable Servo (4)  
EFLREX3L                      3-inch Extension, Lightweight  
EFLREX6L                      6-inch Extension, Lightweight (4)  
EFLREX9L                      9-inch Extension, Lightweight  
EFLREX12L                      12-inch Extension, Lightweight

## Required Tools and Adhesives

---

### Tools & Equipment

Felt-tipped pen	Ball driver: 3/32-inch
Low-tack masking tape	Mixing sticks
Paper towels	Pin drill
Rubbing alcohol	Mixing cups
Drill bits: 1/16-inch (1.5mm)	Hobby knife (#11 blade)
Phillips screwdriver: #0, #1	Straight edge/Ruler
Side cutters	Adjustable wrench, small
Sandpaper	Scissors

### Adhesives

Thin CA	Medium CA
Threadlock	6-minute Epoxy (HAN8000)
Canopy glue	

## Important Information About Motor Selection

---

We recommend the E-flite Power 10 Brushless Outrunner Motor, 1100Kv (EFLM4010A) for maximum performance.

### Brushless Outrunner Setup

---

EFLM4010A	Power 10 Brushless Outrunner Motor 1100Kv
EFLA1040	40-Amp Pro Switch-Mode BEC Brushless
EFLB21003S	E-flite 3S 11.1V 2100mAh 20C Li-Po or Thunder Power 3S 11.1V 2200mAh 25C eXtreme V2 Li-Po (THP22003SXV)
EFLAEC311	EC3 Extension Lead w/6" Wire, 16GA
APC12060E	12x6 Electric Propeller

### Optional Accessories

---

EFLA110	Power Meter
EFLC3005	Celectra™ 1- to 3-Cell Li-Po Charger
EFLC505	Intelligent 1- to 5-Cell Balancing Charger

## Notes Regarding Servos and ESC

---

**WARNING:** Use of servos other than those we suggest may overload the BEC of the recommended Electronic Speed Control (ESC). Please use only the servos listed when utilizing the recommended ESC's BEC, or the use of a separate BEC (like the UBEC) or receiver battery pack when using other servos.

### Note on Lithium Polymer Batteries

---



Lithium Polymer batteries are significantly more volatile than alkaline or Ni-Cd/Ni-MH batteries used in RC applications. All manufacturer's instructions and warnings must be followed closely. Mishandling of Li-Po batteries can result in fire. Always follow the manufacturer's instructions when disposing of Lithium Polymer batteries.

### Warning

---

An RC aircraft is not a toy! If misused, it can cause serious bodily harm and damage to property. Fly only in open areas, preferably at AMA (Academy of Model Aeronautics) approved flying sites, following all instructions included with your radio.

Keep loose items that can get entangled in the propeller away from the prop, including loose clothing, or other objects such as pencils and screwdrivers. Especially keep your hands away from the propeller.

# Warranty Information

---

## Warranty Period

---

Horizon Hobby, Inc., (Horizon) warrants that the Products purchased (the "Product") will be free from defects in materials and workmanship at the date of purchase by the Purchaser.

## Limited Warranty

---

(a) This warranty is limited to the original Purchaser ("Purchaser") and is not transferable. REPAIR OR REPLACEMENT AS PROVIDED UNDER THIS WARRANTY IS THE EXCLUSIVE REMEDY OF THE PURCHASER. This warranty covers only those Products purchased from an authorized Horizon dealer. Third party transactions are not covered by this warranty. Proof of purchase is required for warranty claims. Further, Horizon reserves the right to change or modify this warranty without notice and disclaims all other warranties, express or implied.

(b) Limitations- HORIZON MAKES NO WARRANTY OR REPRESENTATION, EXPRESS OR IMPLIED, ABOUT NON-INFRINGEMENT, MERCHANTABILITY OR FITNESS FOR A PARTICULAR PURPOSE OF THE PRODUCT. THE PURCHASER ACKNOWLEDGES THAT THEY ALONE HAVE DETERMINED THAT THE PRODUCT WILL SUITABLY MEET THE REQUIREMENTS OF THE PURCHASER'S INTENDED USE.

(c) Purchaser Remedy- Horizon's sole obligation hereunder shall be that Horizon will, at its option, (i) repair or (ii) replace, any Product determined by Horizon to be defective. In the event of a defect, these are the Purchaser's exclusive remedies. Horizon reserves the right to inspect any and all equipment involved in a warranty claim. Repair or replacement decisions are at the sole discretion of Horizon. This warranty does not cover cosmetic damage or damage due to acts of God, accident, misuse, abuse, negligence, commercial use, or modification of or to any part of the Product. This warranty does not cover damage due to improper installation, operation, maintenance, or attempted repair by anyone other than Horizon. Return of any goods by Purchaser must be approved in writing by Horizon before shipment.

## Damage Limits

---

HORIZON SHALL NOT BE LIABLE FOR SPECIAL, INDIRECT OR CONSEQUENTIAL DAMAGES, LOSS OF PROFITS OR PRODUCTION OR COMMERCIAL LOSS IN ANY WAY CONNECTED WITH THE PRODUCT, WHETHER SUCH CLAIM IS BASED IN CONTRACT, WARRANTY, NEGLIGENCE, OR STRICT LIABILITY. Further, in no event shall the liability of Horizon exceed the individual price of the Product on which liability is asserted. As Horizon has no control over use, setup, final assembly, modification or misuse, no liability shall be assumed nor accepted for any resulting damage or injury. By the act of use, setup or assembly, the user accepts all resulting liability.

If you as the Purchaser or user are not prepared to accept the liability associated with the use of this Product, you are advised to return this Product immediately in new and unused condition to the place of purchase.

Law: These Terms are governed by Illinois law (without regard to conflict of law principals).

## Safety Precautions

---

This is a sophisticated hobby Product and not a toy. It must be operated with caution and common sense and requires some basic mechanical ability. Failure to operate this Product in a safe and responsible manner could result in injury or damage to the Product or other property. This Product is not intended for use by children without direct adult supervision. The Product manual contains instructions for safety, operation and maintenance. It is essential to read and follow all the instructions and warnings in the manual, prior to assembly, setup or use, in order to operate correctly and avoid damage or injury.

## Questions, Assistance, and Repairs

---

Your local hobby store and/or place of purchase cannot provide warranty support or repair. Once assembly, setup or use of the Product has been started, you must contact Horizon directly. This will enable Horizon to better answer your questions and service you in the event that you may need any assistance. For questions or assistance, please direct your email to [productsupport@horizonhobby.com](mailto:productsupport@horizonhobby.com), or call 877.504.0233 toll free to speak to a service technician.

## Inspection or Repairs

---

If this Product needs to be inspected or repaired, please call for a Return Merchandise Authorization (RMA). Pack the Product securely using a shipping carton. Please note that original boxes may be included, but are not designed to withstand the rigors of shipping without additional protection. Ship via a carrier that provides tracking and insurance for lost or damaged parcels, as **Horizon is not responsible for merchandise until it arrives and is accepted at our facility**. A Service Repair Request is available at [www.horizonhobby.com](http://www.horizonhobby.com) on the "Support" tab. If you do not have internet access, please include a letter with your complete name, street address, email address and phone number where you can be reached during business days, your RMA number, a list of the included items, method of payment for any non-warranty expenses and a brief summary of the problem. Your original sales receipt must also be included for warranty consideration. Be sure your name, address, and RMA number are clearly written on the outside of the shipping carton.

## Warranty Inspection and Repairs

---

**To receive warranty service, you must include your original sales receipt** verifying the proof-of-purchase date. Provided warranty conditions have been met, your Product will be repaired or replaced free of charge. Repair or replacement decisions are at the sole discretion of Horizon Hobby.

## Non-Warranty Repairs

---

**Should your repair not be covered by warranty the repair will be completed and payment will be required without notification or estimate of the expense unless the expense exceeds 50% of the retail purchase cost.** By submitting the item for repair you are agreeing to payment of the repair without notification. Repair estimates are available upon request. You must include this request with your repair. Non-warranty repair estimates will be billed a minimum of ½ hour of labor. In addition you will be billed for return freight. Please advise us of your preferred method of payment. Horizon accepts money orders and cashiers checks, as well as Visa, MasterCard, American Express, and Discover cards. If you choose to pay by credit card, please include your credit card number and expiration date. Any repair left unpaid or unclaimed after 90 days will be considered abandoned and will be disposed of accordingly. **Please note: non-warranty repair is only available on electronics and model engines.**

Electronics and engines requiring inspection or repair should be shipped to the following address:

Horizon Service Center  
4105 Fieldstone Road  
Champaign, Illinois 61822

or

Horizon Hobby UK  
Units 1-4, Ployters Road  
Staple Tye - Southern Way  
Harlow  
Essex  
CM187NS  
United Kingdom

All other Products requiring warranty inspection or repair should be shipped to the following address:

Horizon Product Support  
4105 Fieldstone Road  
Champaign, Illinois 61822

**Please call 877-504-0233 or visit [horizonhobby.com](http://horizonhobby.com) to find our distributor for your country for support with any questions or concerns regarding this product or warranty.**

## Safety, Precautions, and Warnings

As the user of this product, you are solely responsible for operating it in a manner that does not endanger yourself and others or result in damage to the product or the property of others.

Carefully follow the directions and warnings for this and any optional support equipment (chargers, rechargeable battery packs, etc.) that you use.

This model is controlled by a radio signal that is subject to interference from many sources outside your control. This interference can cause momentary loss of control so it is necessary to always keep a safe distance in all directions around your model, as this margin will help to avoid collisions or injury.

- Always operate your model in an open area away from cars, traffic or people.
- Avoid operating your model in the street where injury or damage can occur.
- Never operate the model out into the street or populated areas for any reason.
- Never operate your model with low transmitter batteries.
- Carefully follow the directions and warnings for this and any optional support equipment (chargers, rechargeable battery packs, etc.) that you use.
- Keep all chemicals, small parts and anything electrical out of the reach of children.
- Moisture causes damage to electronics. Avoid water exposure to all equipment not specifically designed and protected for this purpose.

## Hinging the Ailerons

### Required Parts

Top wing	Top ailerons (right and left)
Bottom wing	Bottom ailerons (right and left)
CA hinge (16)	

### Required Tools and Adhesives

Felt-tipped pen	Straight edge/ruler
Hobby knife	Thin CA
Scissors	

- 1. Use scissors or a hobby knife to cut each hinge away from the others.
- 2. Use a felt-tipped pen to mark the center of four CA hinges. This will help in positioning them equally in the aileron and wing.



- 3. Position the hinges in the pre-cut slots in the aileron. Slide the hinges into the aileron up to the mark made in the previous step.

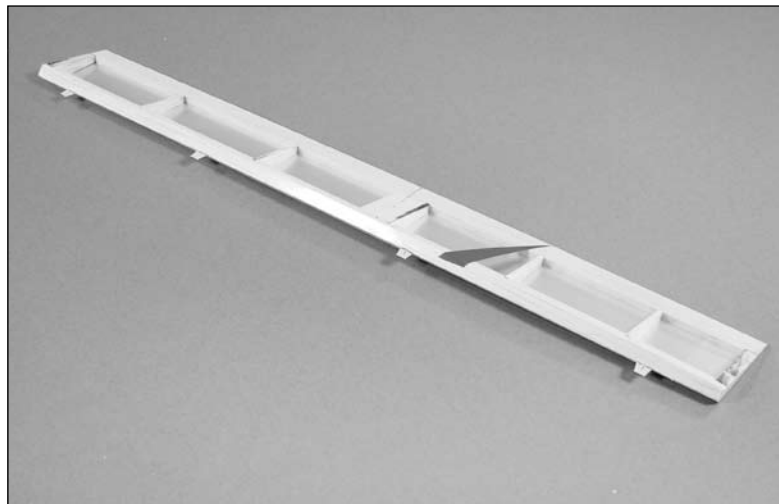

- 4. Slide the aileron in position with the hinges inserted in the slots of the wing. Check that the end of the aileron is aligned with the wing tip using a straight edge.

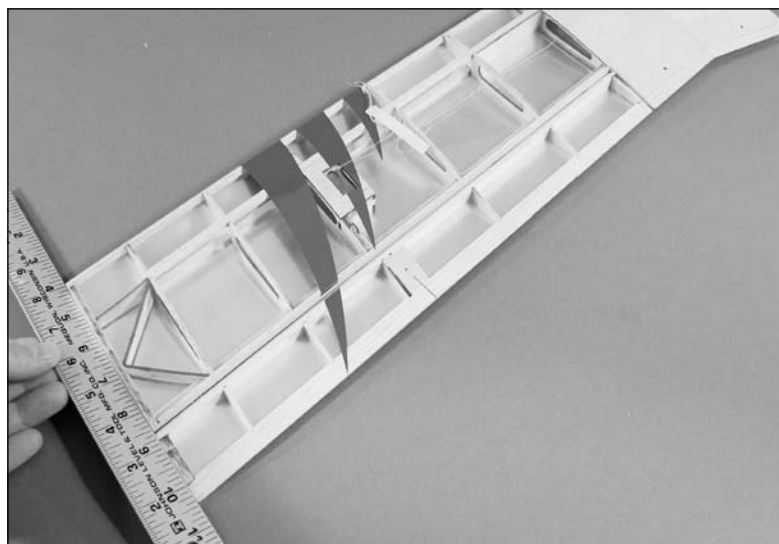

- 5. Make sure the aileron does not bind at the center of the wing.

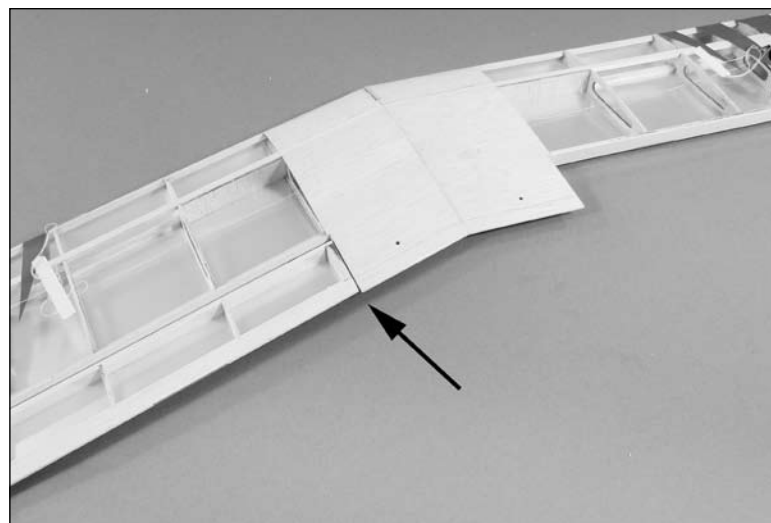

- 6. Use a hobby knife with a #11 blade to set the gap between the aileron and wing. The blade should barely slide between the two surfaces. Doing so will allow achieving the control throws listed with the smallest gap possible.

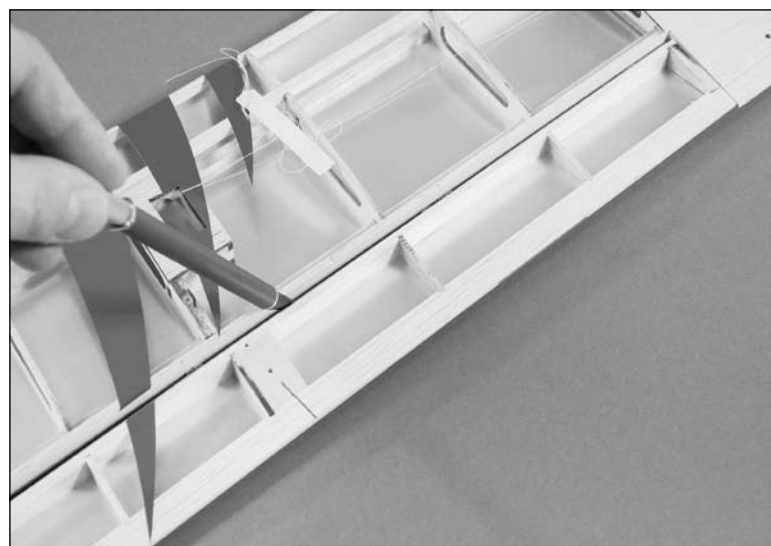



**Note:** If the control surface is tight against the main surface, it will limit the amount of control throw the surface can achieve.

- ○ ○ ○ 7. Apply thin CA to the top and bottom of each hinge. Make sure to saturate the hinges, applying the CA to the slot in the hinge so it penetrates fully into the hinge for the best bond between the aileron and wing.



- ○ 8. Repeat Steps 2 through 7 for the remaining aileron on the bottom wing.

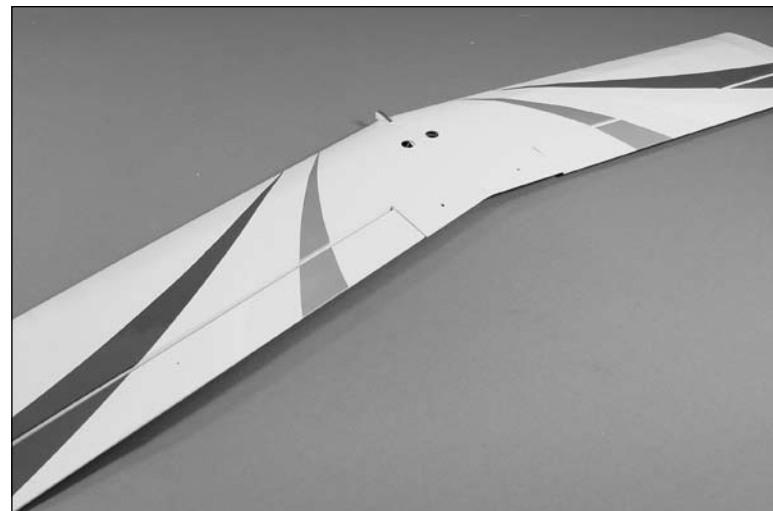

- 9. Repeat Steps 2 through 8 to attach the aileron to the top wing. You should now be done with the aileron installation.

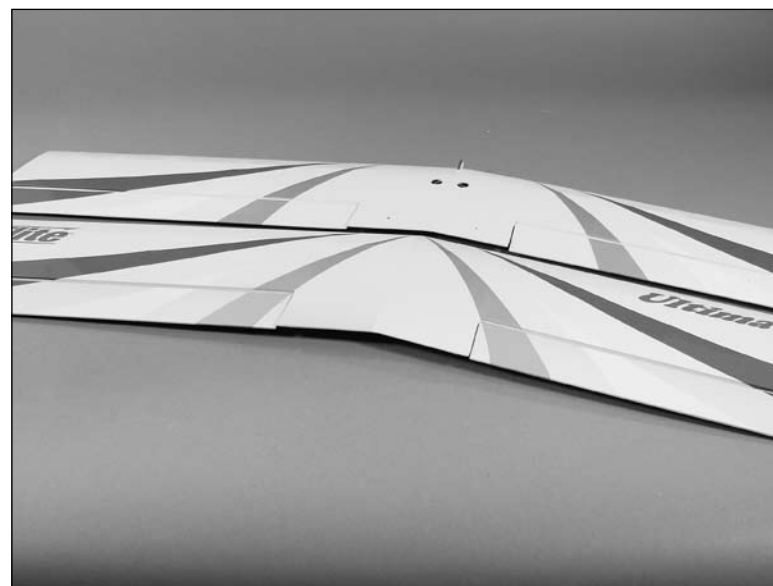

- 10. Once the CA has fully cured, lightly pull on each surface to make sure that each hinge has been fully saturated with CA.

## Aileron Servo Installation

### Required Parts

Top wing	Bottom wing
Control horn (2)	Interconnect horn (4)
Aileron servo (2)	Silicone clevis retainer (2)
Nylon connector backplate (2)	Machine screw, 2mm x 4mm (2)
6-inch (152mm) servo extension (2)	
Lightweight screw lock connector (2)	
Servo linkage, 2.5-inch (62mm) (2)	

### Required Tools and Adhesives

Medium CA	Thin CA
Side cutters	Hobby knife
Low-tack tape	Pin drill
Drill bit: 1/16-inch (1.5mm)	Phillips screwdriver: #0, #1
Felt-tipped pen	

- 1. Slide the control horn into the pre-drilled holes in the aileron. Use a felt-tipped pen to mark the area around the base of the control horn. Remove the horn and use a hobby knife to cut the covering away from the area inside the outline. Use side cutters to trim 2-3mm off of the aft lug on the control horn. This will eliminate the lug protruding through the other side of the aileron. Use medium CA to glue the control horn in the holes in the aileron. Make sure the horn rests flush with the surface of the aileron.

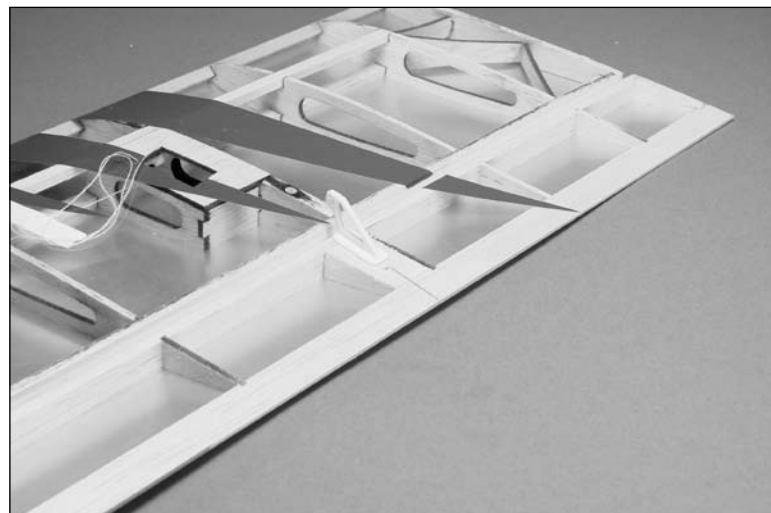

**Note:** The aileron control horns do not require back plates.

- 2. Use a hobby knife to trim the covering from the slot in the aileron. Leave the covering on the top for aesthetic purposes. Use medium CA to glue the interconnect horn in the aileron. Make sure to center the horn in the aileron before the CA fully cures.

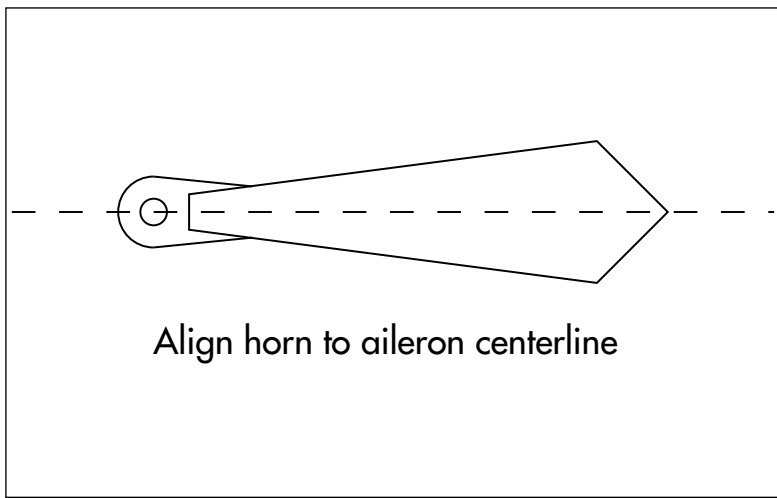
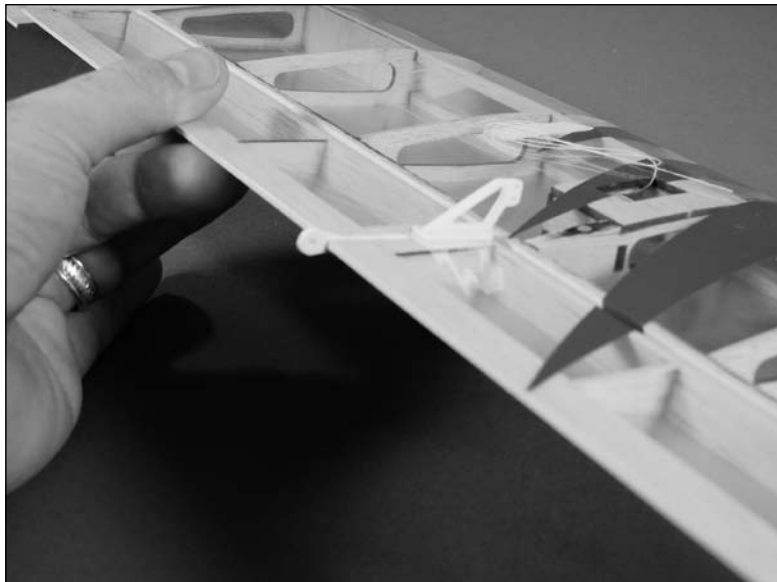

- 3. Repeat Step 2 for the top aileron at this time.

- 4. Secure a 6-inch (152mm) servo extension to the aileron servo so it will not unplug inside the wing.

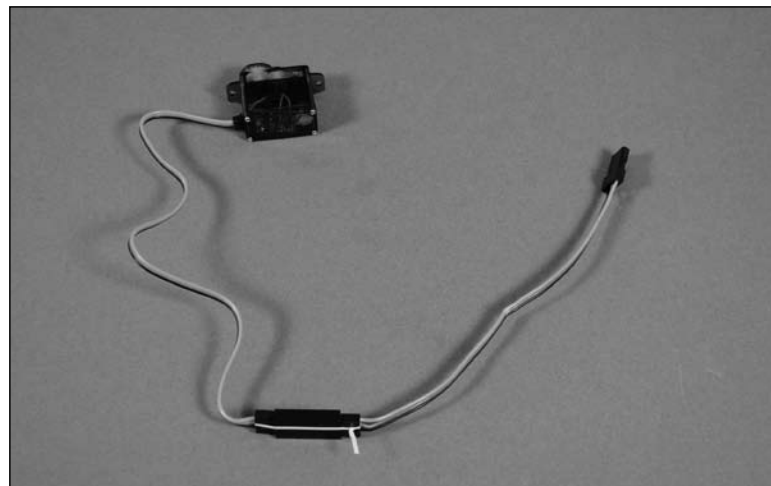

**Hint:** Use a piece of string or some tape to secure the two plugs together so that they cannot pull apart inside the wing.

- 5. A string has been placed inside the wing to pull the servo extension to the center of the wing. Tie this string to the end of the servo extension as shown.

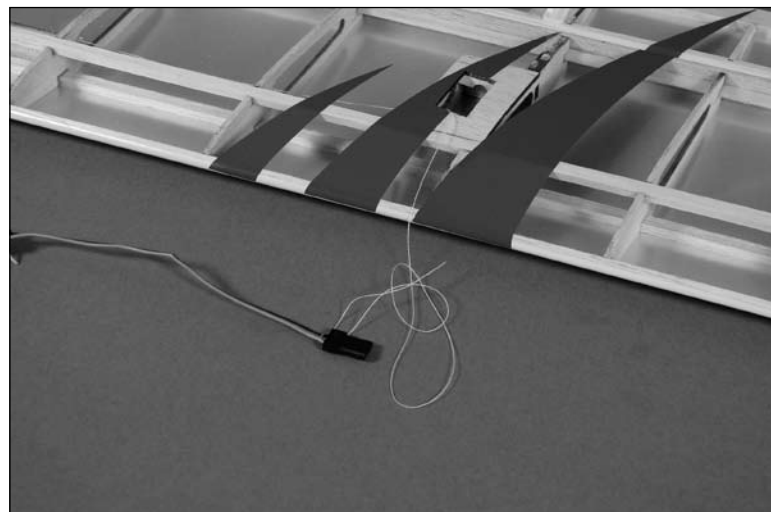

- 6. Use the string to pull the extension through the hole at the center of the bottom wing.

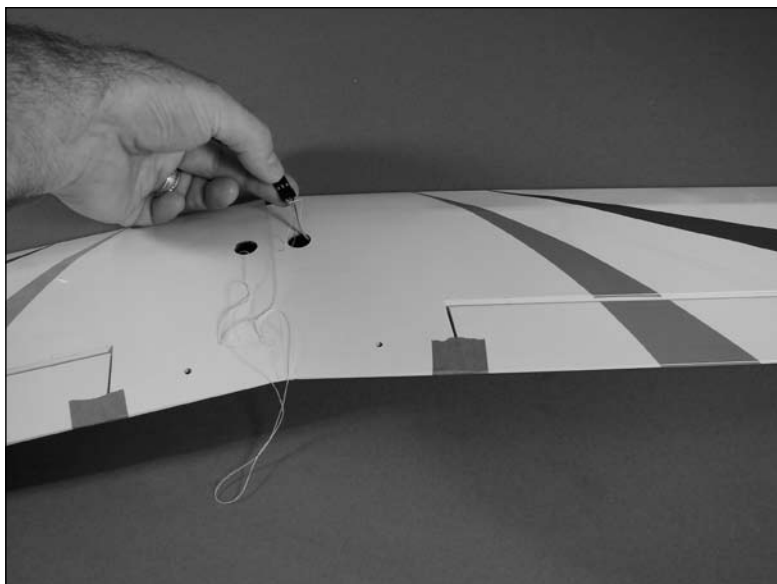

**Hint:** Use low-tack tape to keep the ailerons from moving during the servo installation.

- 7. Position the servo in the opening. Use a pin drill and 1/16-inch (1.5mm) drill bit to drill the holes for the servo mounting screws. Use care not to slip and puncture the covering on the top of the wing.

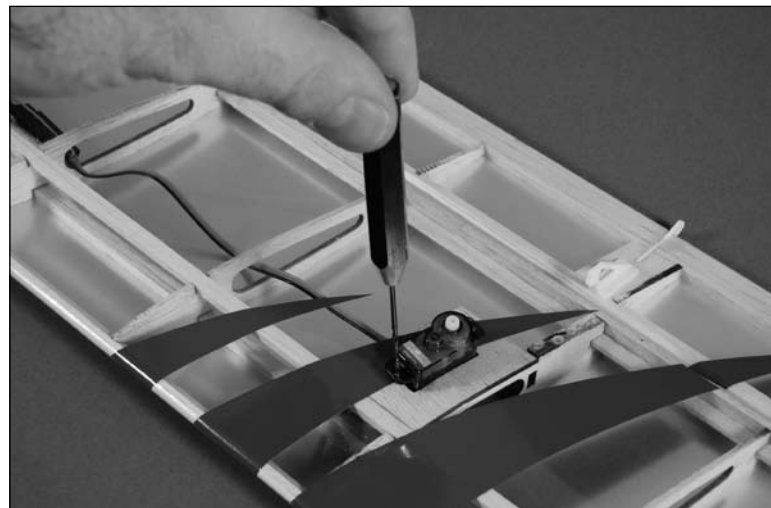

- 8. Apply 2–3 drops of thin CA into each hole to harden the surrounding wood. This will keep the screws secure in the holes. Install the servo using the screws provided with the servo and a #0 Phillips screwdriver.

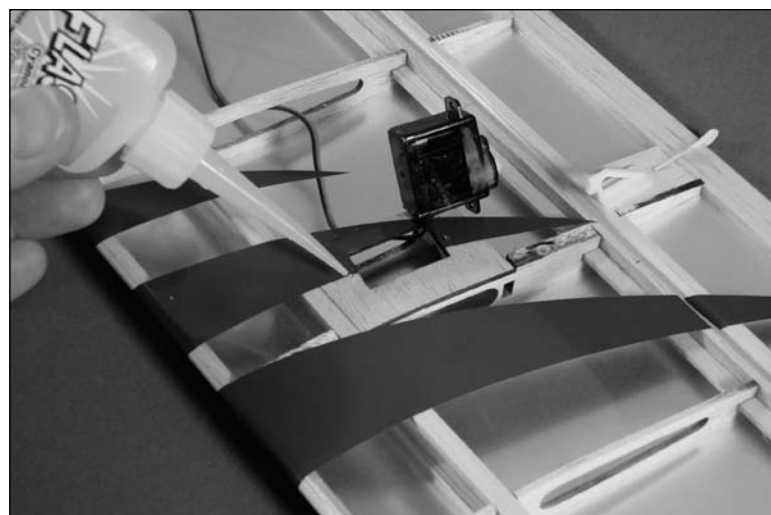

- 9. Repeat Steps 1 through 8 for remaining control horns and servo.

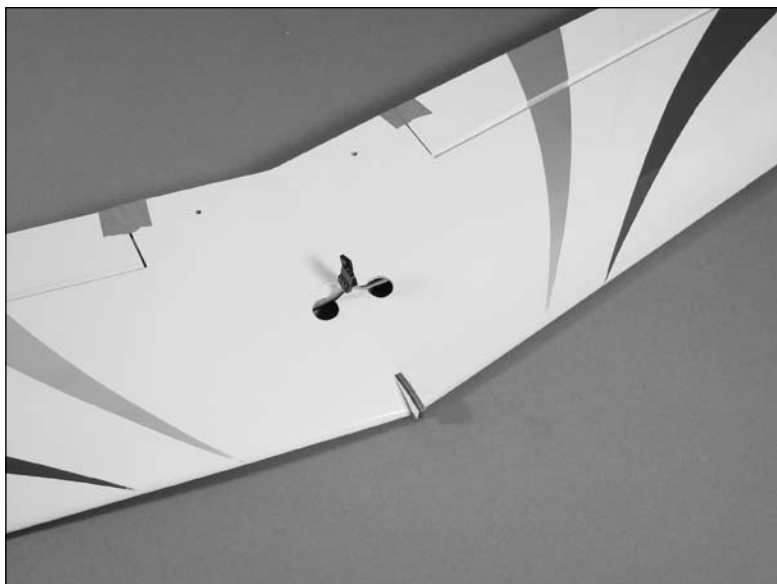

- 10. Use a pin drill and 1/16-inch (1.5mm) drill bit to enlarge the hole that is 1/2-inch (13mm) from the center of the servo horn.

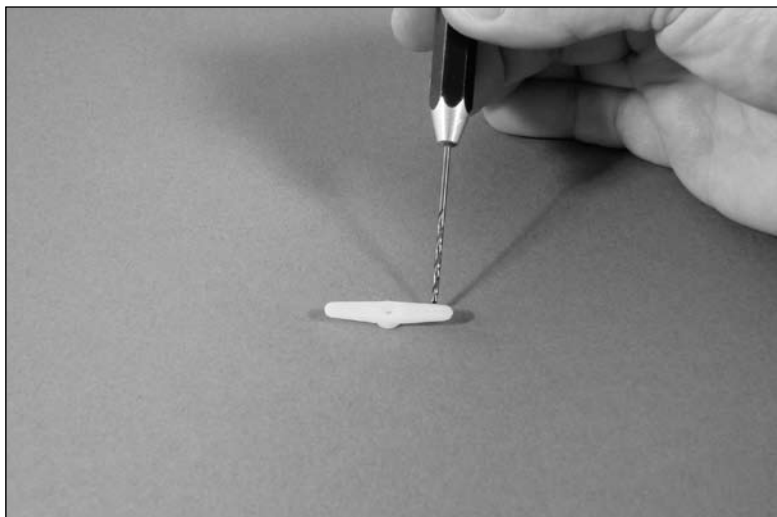

- 11. Use a hobby knife to remove the webbing from the underside of the servo horn so the connector backplate will rest flush against the horn.

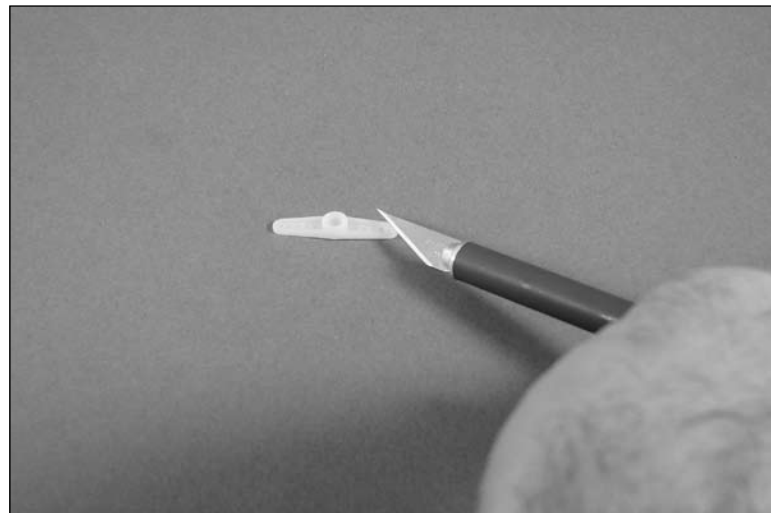

- 12. Use side cutters to remove the unused arm from the servo horn.

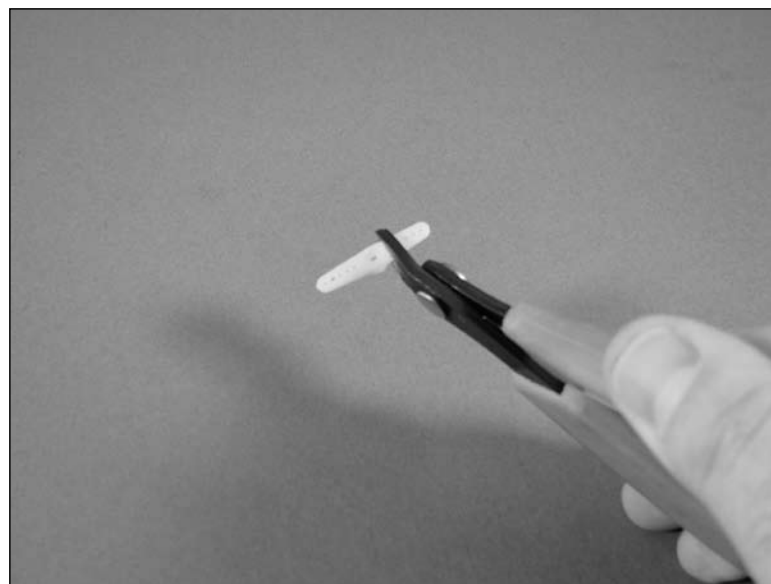

- ○ 13. Slide the lightweight screw lock connector into the hole drilled back in Step 10.



- ○ 14. Use the connector backplate to secure the connector.

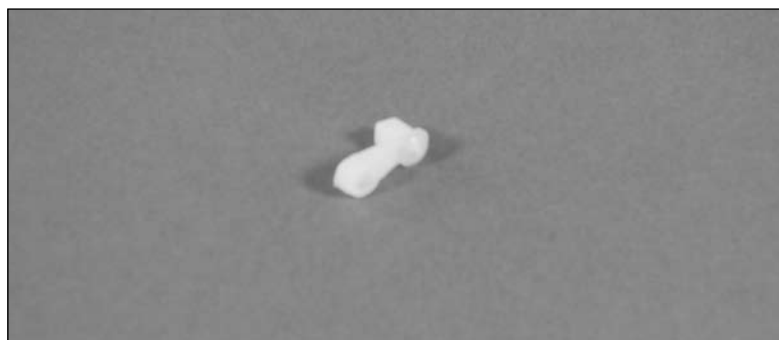

- ○ 15. Slide a clevis retainer onto the clevis of the 2.5-inch (62mm) servo linkage.

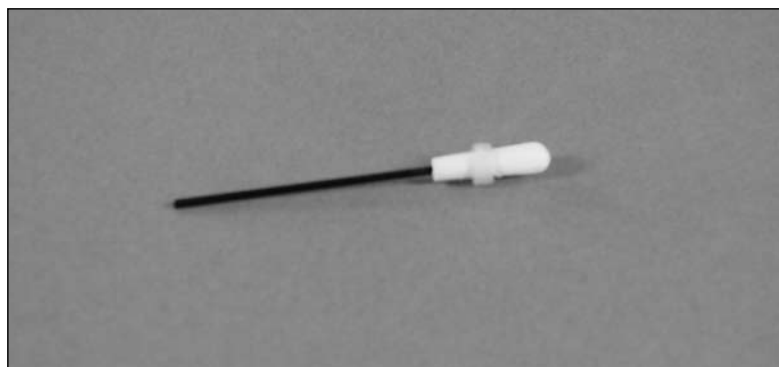

- ○ 16. Attach the clevis to the outer hole of the control horn and slide the retainer onto the clevis to keep it secure.

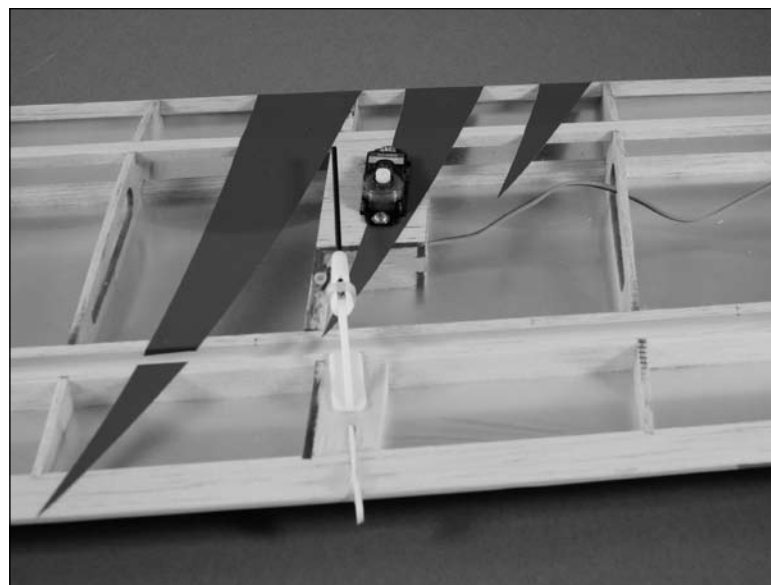

- ○ 17. Slide the linkage through the hole in the lightweight linkage connector and attach the horn to the servo.



**Note:** The servo horn should be installed parallel to the hinge line to produce the correct linkage geometry.

**Important:** The suggested digital servos will require programming before setting the control throws. This will be covered in the manual before the throws are set.

- ○ 18. Use a 2mm x 4mm machine screw and #1 Phillips screwdriver to secure the linkage to the connector.



**Hint:** The aileron should be centered and the servo horn aligned with the aileron hinge line before tightening the screw.

- 19. Repeat Steps 10 through 18 for the remaining servo linkage.

## Stabilizer Installation

### Required Parts

Bottom wing	Fuselage
#4 washer, silver (2)	Stabilizer
Socket head screw, 4-40 x 1-inch (2)	
Elevator joiner wire	

### Required Tools and Adhesives

Ball driver: 3/32-inch	Felt-tipped pen
Hobby knife	Thin CA
Sandpaper	

- 1. Attach the bottom wing to the fuselage using a two 4-40 x 1-inch socket head screws and two #4 washers. Use the larger silver washers when attaching the bottom wing. Use a 3/32-inch ball driver to tighten the socket head screws.

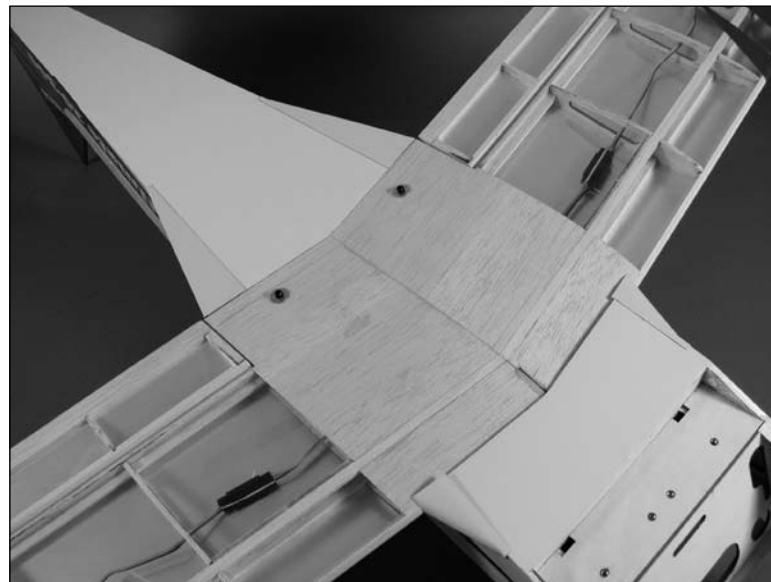

- 2. Slide the stabilizer into the slot at the rear of the fuselage. Slide the stabilizer forward, then align it side-to-side with the fuselage.

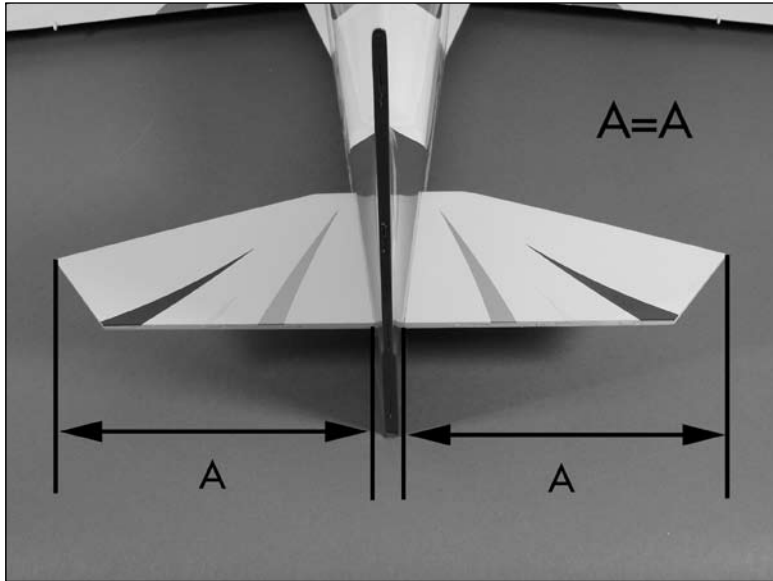

- 3. Measure from each wing tip to each stabilizer tip. The distances on the right must match those on the left. Reposition the stabilizer to achieve equal measurements.

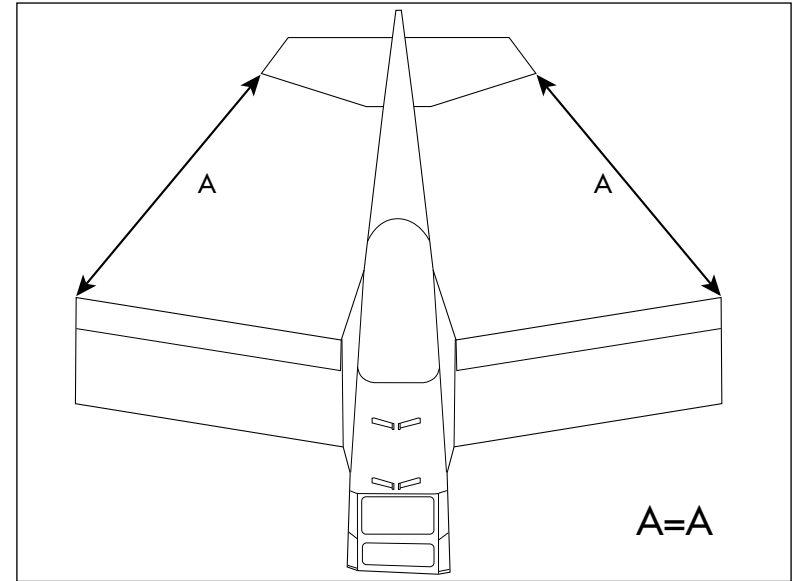

- 4. Stand back and view the aircraft from the rear. The stabilizer must be parallel to the bottom wing. It may be necessary to lightly sand the opening in the fuselage for the stabilizer to correct this alignment.

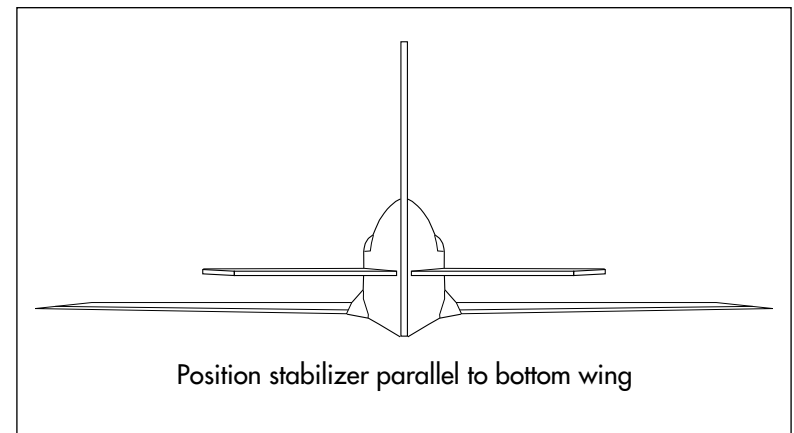



- 5. Once aligned, use a felt-tipped pen to trace the outline of the fuselage onto the top and bottom of the stabilizer.

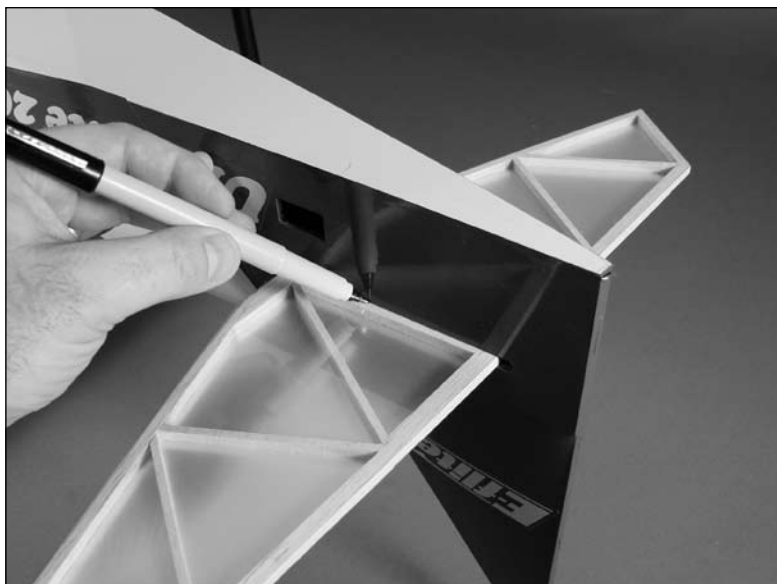

- 6. Remove the stabilizer from the fuselage. Use a hobby knife with a new #11 blade to trim the covering slightly **INSIDE** the lines drawn on the stabilizer. Use light pressure so you do not cut into the underlying wood. Remove the covering from the inside of the cut lines on the top and bottom of the stabilizer.

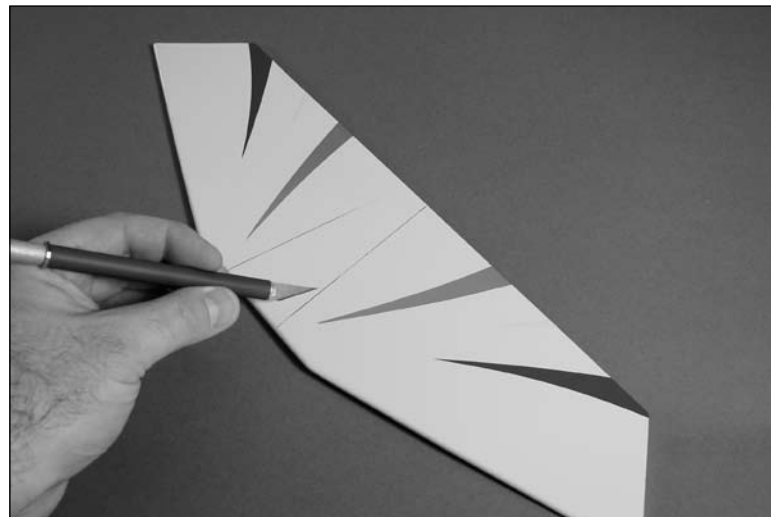

**Important:** Cutting into the underlying wood will weaken the stabilizer and it could fail in flight.

**Hint:** Use a soldering iron or hot knife to cut the covering, as they will melt it and require less pressure, reducing the chances of cutting into the underlying wood.

- 7. Slide the elevator joiner wire into the slot for the stabilizer before gluing the stabilizer into position.



**Hint:** To avoid leaving the marks of the lines from the pen where the location marks are made on the stabilizer, use alcohol and a paper towel to remove the lines from the top of the stabilizer first. Then slide the stabilizer in and wick thin CA on the top left and right joint first, using the bottom lines for the alignment. Now use the alcohol and paper towel to remove the lines from the bottom and glue those joints last.

- 8. Slide the stabilizer back into the fuselage and double-check the alignment as described in Steps 2 through 4. Wick thin CA into the joint between the fuselage and stabilizer to glue it in position. Remember to apply CA to the top and bottom, left and right joints.



## Hinging the Rudder and Stabilizer

### Required Parts

Elevator (left and right)	Rudder
Tail wheel assembly	Fuselage
CA hinge (10)	Control horn
Control horn backplate	

### Required Tools and Adhesives

Medium CA	Felt-tipped pen
Hobby knife	Thin CA
6-minute epoxy	Mixing sticks
Mixing cups	Rubbing alcohol
Paper towels	

**Note:** The first few steps of installing the elevators is necessary to make sure everything will operate properly. Do not use any adhesives until instructed to do so.

- ○ 1. Use a felt-tipped pen to mark the center of three CA hinges. This will help in positioning them equally in the elevator and stabilizer.



- ○ 2 Slide the three hinges into the elevator, using the line to center them properly. Install the control horn in the stabilizer on the bottom side. Use a felt-tipped pen to mark the area around the base of the control horn. Remove the horn and use a hobby knife to cut the covering away from the area inside the outline. Glue the control horn using medium CA. A control horn backplate is also installed on the top side of the elevator. Remove the covering under this also.

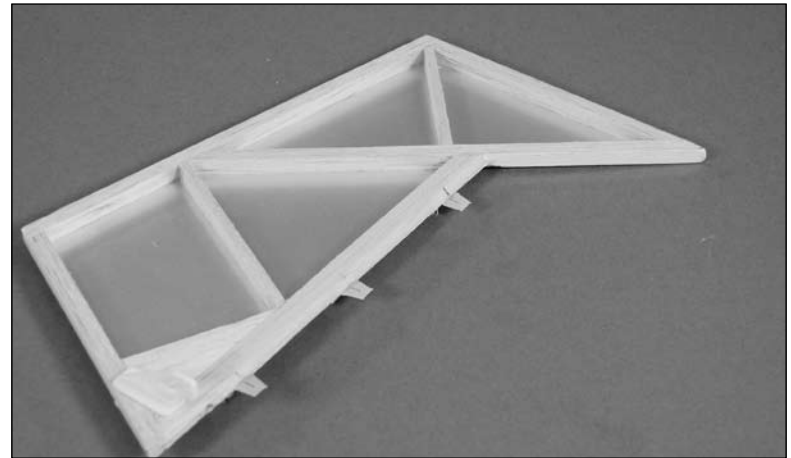

- ○ 3. Slide the elevator onto the elevator joiner wire.



- ○ 4. Slide the hinges in the slots in the stabilizer.

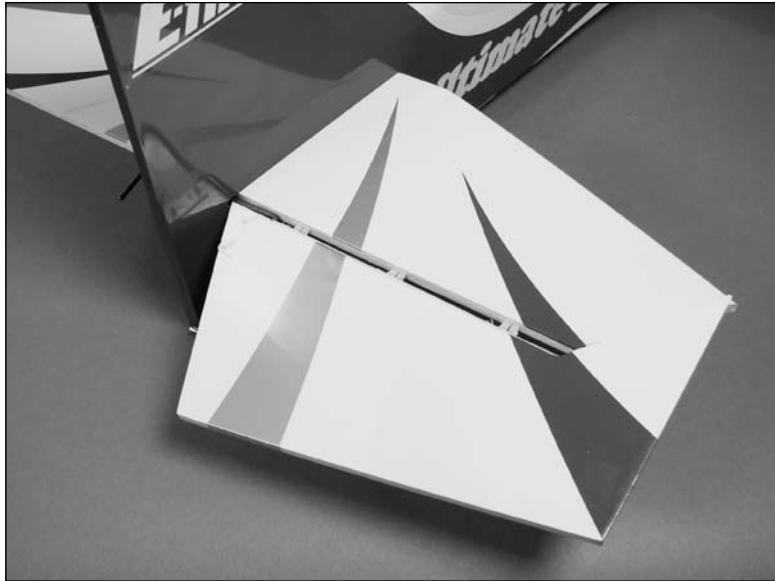

- 5. Repeat Steps 1 through 4 to position the remaining elevator half.

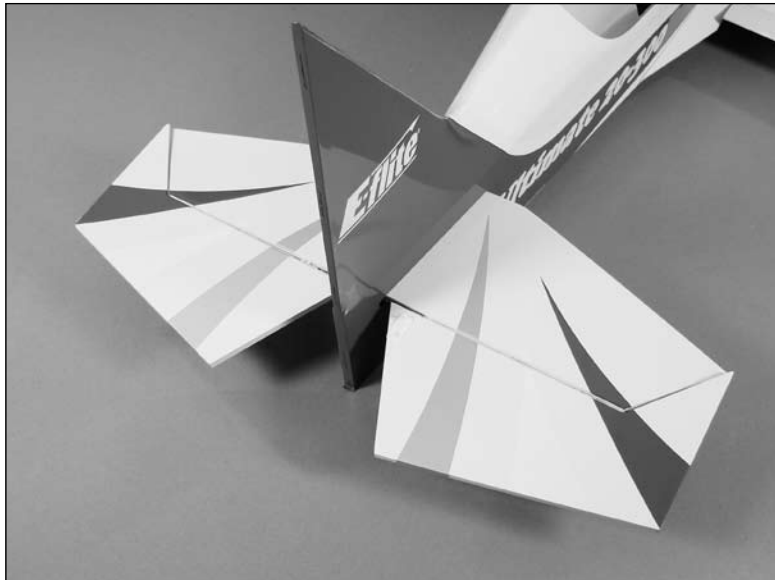

- 6. Position the elevators so the gap between the stabilizer tip and the balance tabs of the elevators are equal. Check the operation of the elevator to make sure it does not bind against the stabilizer.
- 7. Mix a small amount of 6-minute epoxy and apply it inside the hole in the elevator that the joiner wire fits into. Follow the previous steps to position the stabilizer before the epoxy cures. Be very careful to make sure that no epoxy runs back out of the joiner hole. If any does use alcohol and paper towels to remove any excess.



- 8. Use a hobby knife to set the gap between the stabilizer and elevator, similar to that of the aileron hinge installation. Apply thin CA to the top and bottom of each hinge. Make sure to saturate the hinges, applying the CA to the slot in the hinge so it penetrates fully into the hinge for the best bond between the stabilizer and elevator.

- 9. Use medium CA to glue the tail wheel assembly into the slot at the bottom of the rudder.

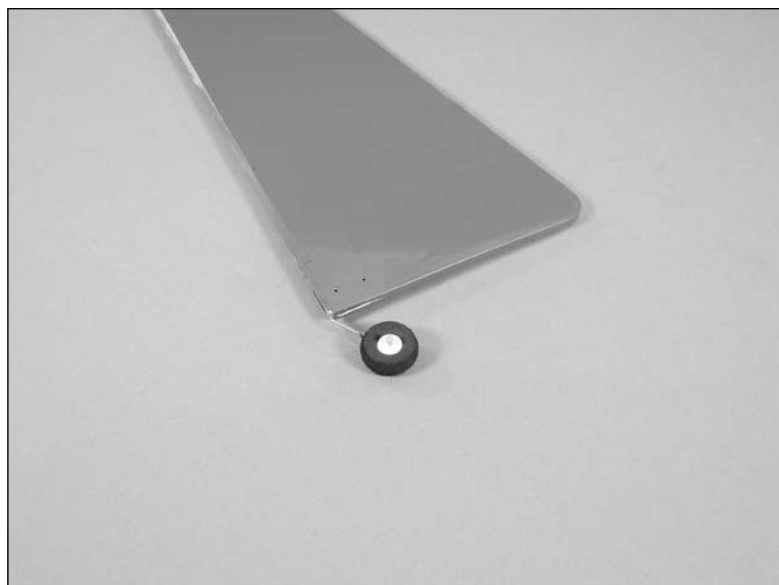

- 10. Mark four CA hinges and install them in the slots in the rudder as shown.

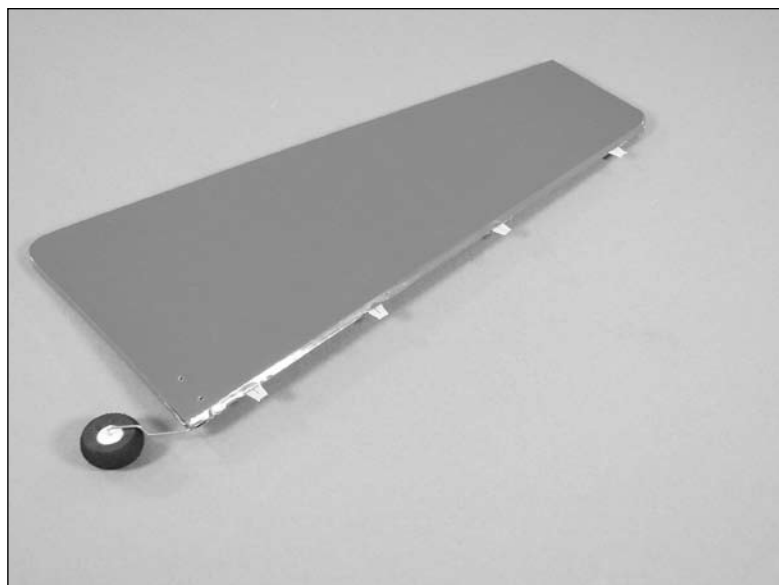

- 11. Attach the rudder to the fin using the hinges. Remember to use a hobby knife to set the gap between the rudder and fin. Apply thin CA to each side of the hinges. Make sure to saturate the hinges, applying the CA to the slot in the hinge so it penetrates fully into the hinge for the best bond between the rudder and fin.



- 12. After CA is fully cured, pull on all surfaces lightly to make sure that each hinge is fully saturated and bonded.

## Rudder and Elevator Servo Installation

### Required Parts

Fuselage	Servo (2)
Control horn	Silicone clevis retainer (2)
Control horn backplate	Nylon connector backplate (2)
Machine screw, 2mm x 4mm (2)	
9-inch (228mm) servo extension	
12-inch (305mm) servo extension	
Lightweight screw lock connector (2)	
Servo linkage, 4-inch (98mm) (2)	

### Required Tools and Adhesives

Medium CA	Thin CA
Side cutters	Hobby knife
Low-tack tape	Pin drill
Drill bit: 1/16-inch (1.5mm)	Phillips screwdriver: #1
Felt-tipped pen	

- 1. Slide the control horn into the pre-drilled holes in the rudder. Use a felt-tipped pen to mark the area around the base of the control horn. Remove the horn and use a hobby knife to cut the covering away from the area inside the outline. Use medium CA to attach the control horn to the rudder. Install the control horn backplate on the opposite side of the control horn to secure its position. Remove the covering under this also.



- 2. Prepare a long 3D servo horn by enlarging the hole 1/2-inch (13mm) from the center of the servo horn with a pin drill and 1/16-inch (1.5mm) drill bit. After removing the webbing from the underside of the horn, secure the connector to the horn. Remove the excess from the horn using side cutters.

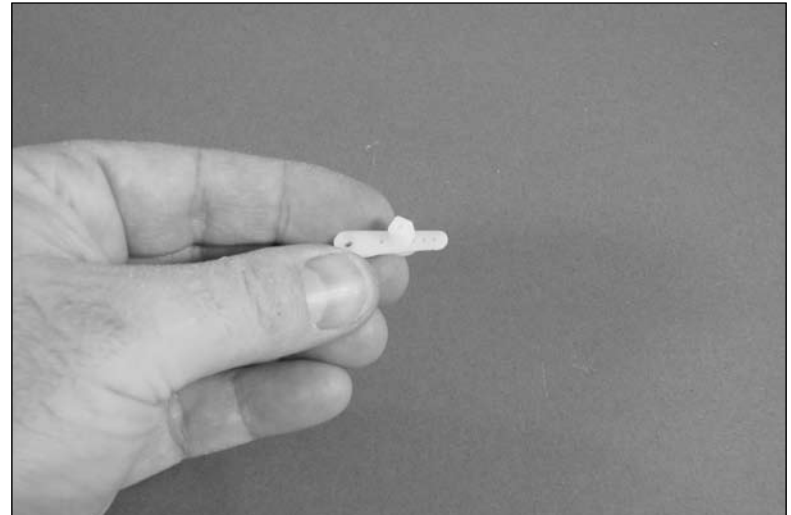

- 3. Secure a 9-inch (228mm) servo extension to the elevator servo so it will not unplug inside the fuselage. Use a 12-inch (305mm) servo extension for the rudder.

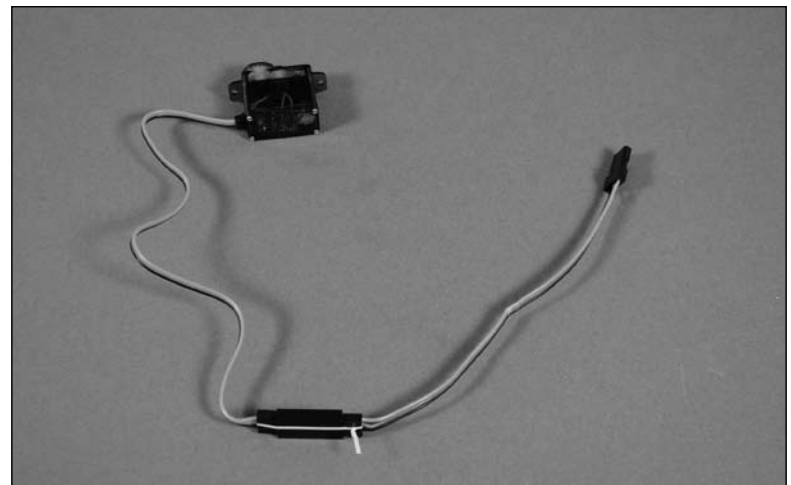

**Hint:** Use a piece of string or some tape to secure the two plugs together so that they cannot pull apart inside the fuselage.

- 4. Position the servo in the opening. Use a pin drill and 1/16-inch (1.5mm) drill bit to drill the holes for the servo mounting screws. Apply 2–3 drops of thin CA into each hole to harden the surrounding wood. This will keep the screws secure in the holes. Install the servo using the screws provided with the servo.
- 5. Install the servo arm perpendicular to the servo.



- 6. Slide a clevis retainer onto the clevis of a 4-inch (98mm) control linkage. Slide the link through the connector and then attach the clevis to the outer hole of the control horn.



- ○ 7. Secure the link using a 2mmx 4mm machine screw and a #1 Phillips screwdriver.



- 8. Repeat Steps 2 through 7 to install the rudder servo and linkage. The only difference is you will use a 12-inch (305mm) extension on the rudder servo.

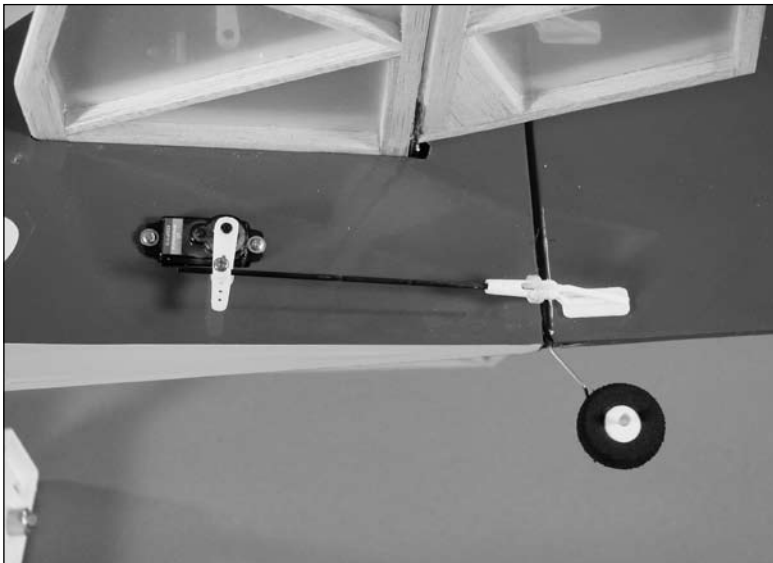

## Receiver and Landing Gear Installation

### **Required Parts**

Fuselage assembly	Main landing gear (right and left)
Receiver	#4 washer, silver (4)
Hook and loop material	6-inch (152mm) servo extension (2)
Socket head screw, 4-40 x 1/2-inch (4)	

### **Required Tools and Adhesives**

Ball driver: 3/32-inch      Threadlock

- 1. Use hook and loop material to install the receiver inside the fuselage as shown. When installing a remote receiver, place it as far away from the main receiver as possible, aligning the antennas perpendicular to those of the main receiver. You can also install the two 6-inch (152mm) extensions for the ailerons or a Y-harness if you are not using a computer radio.

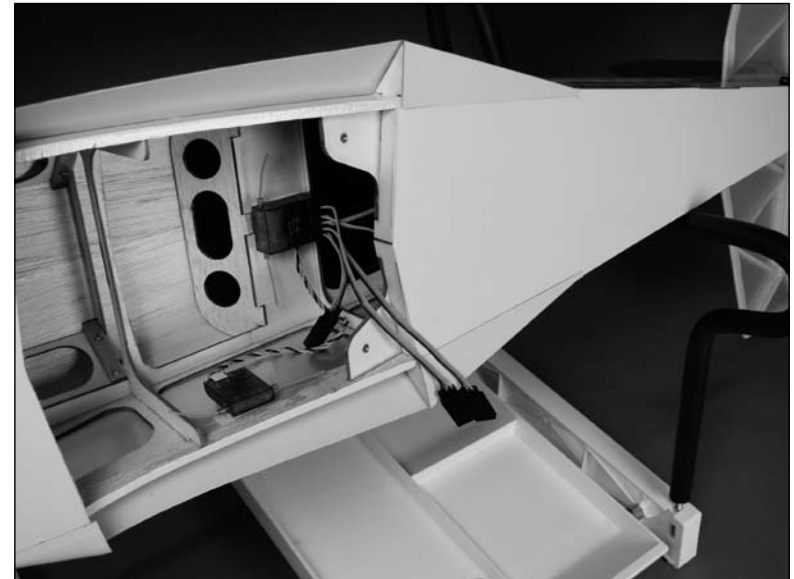



- 2. Use four 4-40 x 1/2-inch socket head screws and four #4 washers to attach the main landing gear to the fuselage. Use a 3/32-inch ball driver to tighten the screws.



**Note:** Use threadlock on the screws to prevent them from vibrating loose.

## Motor and Cowling Installation

### Required Parts

Fuselage assembly	Motor and mount
#4 washer (4)	Hook and loop tape
Hook and loop strap	Cowling
Spinner	Spinner backplate
Speed control	Motor battery
3-inch (76mm) servo extension	
EC3 extension lead w/6-inch wire, 16 GA	
Machine screw, 2mm x 8mm (4)	
Sheet metal screw, 2mm x 8mm (2)	
Socket head screw, 4-40 x 3/8-inch (4)	

### Required Tools and Adhesives

Phillips screwdriver: #1, #2      Ball driver: 3/32-inch  
Threadlock

- 1, Attach the X-mount to the motor using the screws provided with the motor and a #2 Phillips screwdriver.



**Note:** Use threadlock on the screws to prevent them from vibrating loose.

- 2. Attach the motor to the firewall using four 4-40 x 3/8-inch socket head screws and four #4 washers. Tighten the screws using a 3/32-inch ball driver.

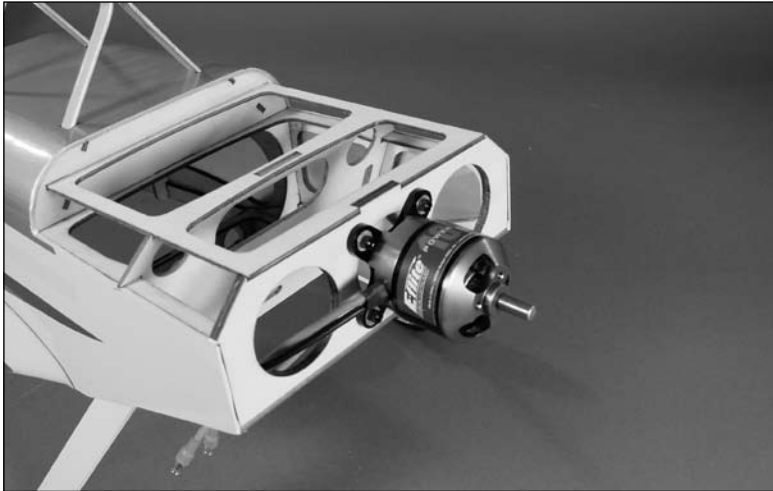

**Note:** Use threadlock on the screws to prevent them from vibrating loose.

- 3. Position the speed control inside the fuselage. Pass the wires for the motor through the lightning holes in the fuselage and connect them to the wires from the motor.

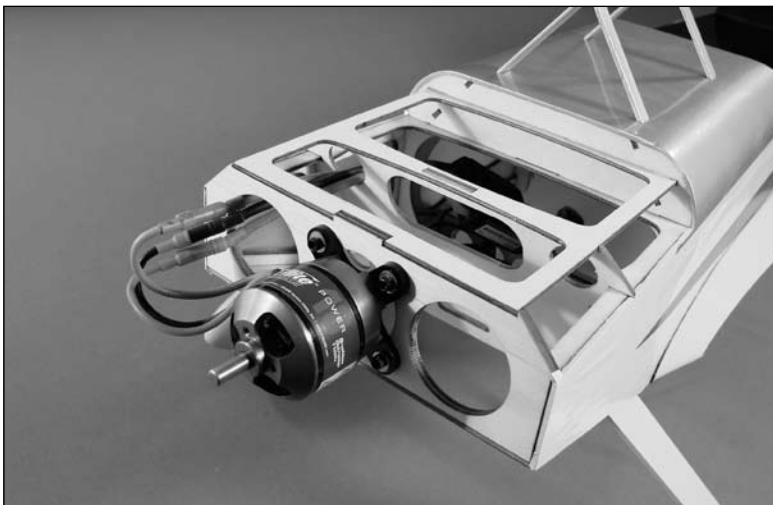

- 4. Use hook and loop material to secure the speed control inside the fuselage in the position shown. Also secure the switch from the speed control inside the fuselage. A 3-inch (76mm) servo extension will be required to connect the speed control to the receiver. A 6-inch EC3 extension will also be required to extend the battery lead to the front of the aircraft at the battery tray.

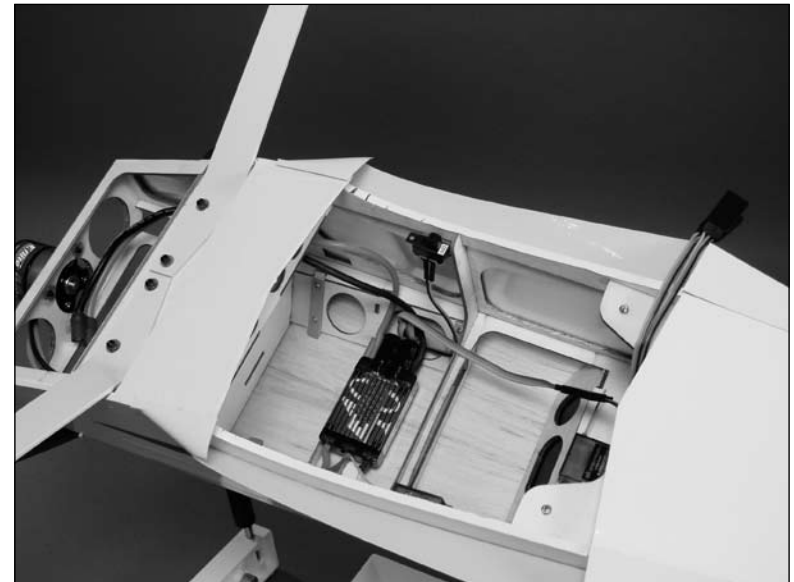

**Note:** If using the E-flite 40-amp speed control, we recommend that you tape the switch in the On position if you are not going to mount it externally. It can be mounted on either side of the fuselage in the holes provided by cutting the covering out of the hole and sliding the switch from the inside to the outside of the fuselage.

#### ***Important Information About Your Brushless ESC***

Make sure your ESC brake is programmed to Off. Also, be sure to use an ESC with the proper low-voltage cutoff and have it set correctly for the batteries you are using.

- 5. Secure a small square of hook and loop material inside the fuselage. This is done to keep the strap that secures the battery from falling into the fuselage.

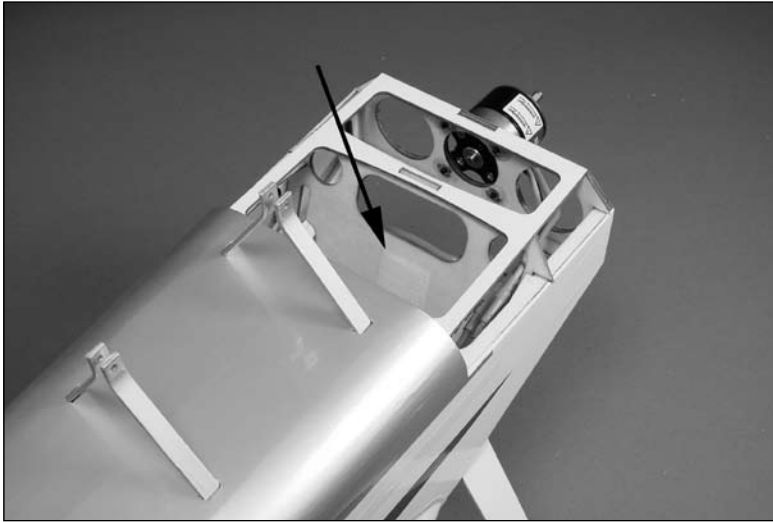

- 6. Secure the battery inside the fuselage using the hook and loop strap. Use a piece or two of hook and loop material between the fuselage and battery to keep it from moving around in flight.



- 7. Check the operation of the motor at this time. It should rotate counterclockwise when viewed from the front of the aircraft. If not, follow the instructions provided with your speed control to correct the situation.

**Note:** Never check the motor rotation on the bench with the propeller installed. The plane could move and cause serious injury. Always check the motor without the propeller to avoid injury.

- 8. Attach the cowling to the fuselage using four 2mm x 8mm machine screws and a #1 Phillips screwdriver. Pieces of tubing have been installed in the fuselage side to accept the screws.

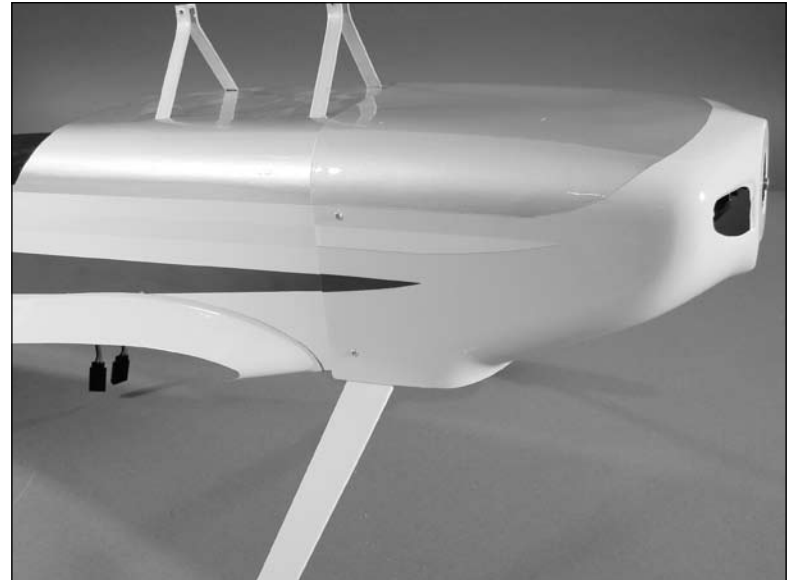

### **Important Information About Your Propeller**

It is also very important to check to be sure the propeller is balanced before installing onto the shaft. An unbalanced propeller may strip the gears or cause poor flight characteristics.

**Note:** If it is necessary to enlarge the hole in the propeller or the spinner, make sure to check the balance of each afterwards.

- 9. Prepare the spinner backplate and propeller as shown with the propeller adapter.

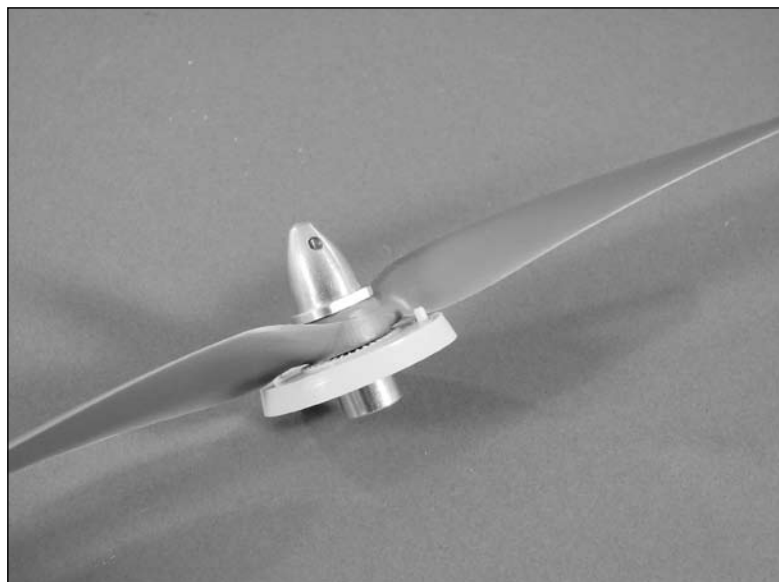

- 10. Slide the propeller assembly onto the motor shaft. With a gap of 3/32-inch (2.5mm) between the spinner and cowling, tighten the adapter to secure it to the motor shaft.

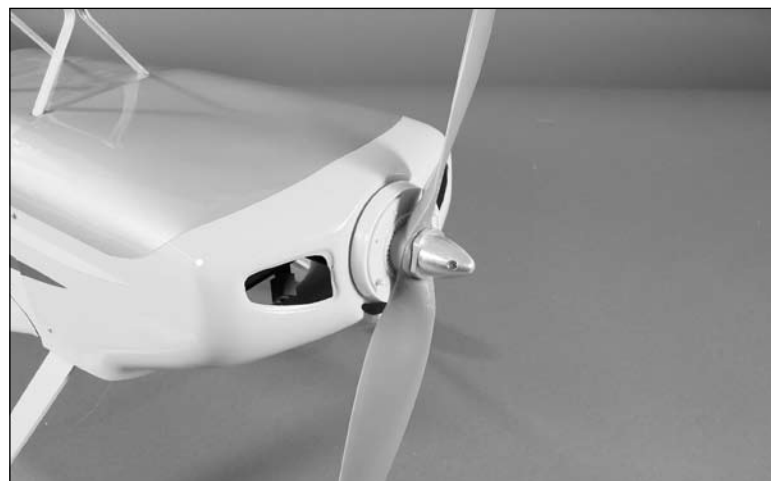

- 11. Attach the spinner cone to the spinner backplate using two 2mm x 8mm sheet metal screws and a #1 Phillips screwdriver. Make sure the propeller does not contact the spinner cone when it is installed.



# Upper Wing and Canopy Installation

## Required Parts

Fuselage	Top wing
Bottom wing	Canopy
2mm nut (2)	2mm washer (4)
Interplane strut (2)	Machine screw, 2mm x 20mm (8)
Linkage, 7.5-inch (190mm) (2)	Machine screw, 2mm x 6mm (2)
Pushrod connector backplate (2)	
Lightweight pushrod connector (2)	
2mm x 10mm machine screws (2)	

## Required Tools and Adhesives

Phillips screwdriver: #1	Pin drill
Drill bit: 1/16-inch (1.5mm)	Low-tack tape
Adjustable wrench, small	Canopy glue

- 1. Use canopy glue to attach the canopy. Use low-tack tape to keep the canopy in position until the glue has fully cured.



- 2. Install the lightweight pushrod connector to the interconnect horn. It may be necessary to enlarge the hole in the interconnect horn on the bottom ailerons using a pin drill and 1/16-inch (1.5mm) drill bit. Repeat for the other aileron.

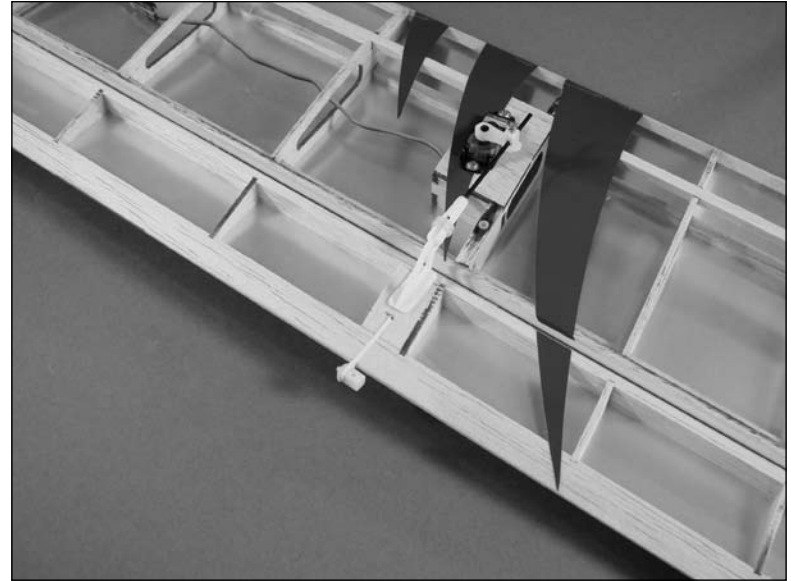

- 3. Use a pin drill and 1/16-inch (1.5mm) drill bit to poke the covering to access the screw holes for the interplane struts.

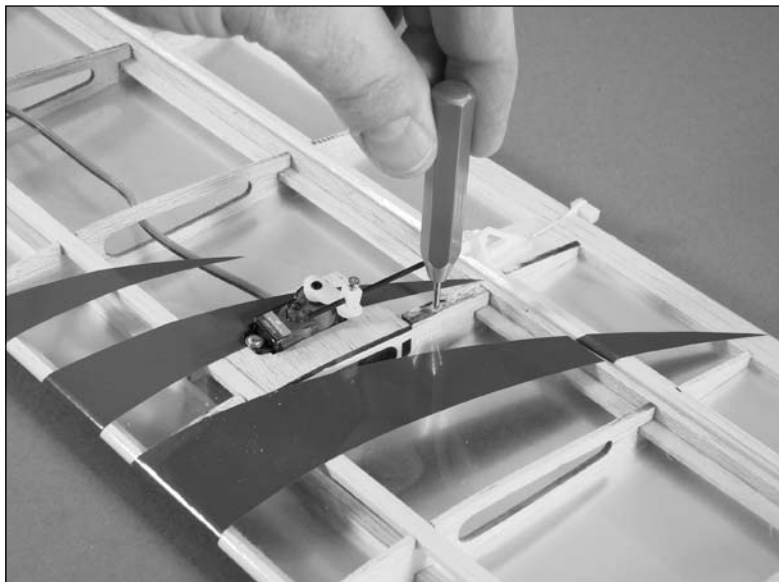

- 4. Use the following image to orient the interplane struts for installation.

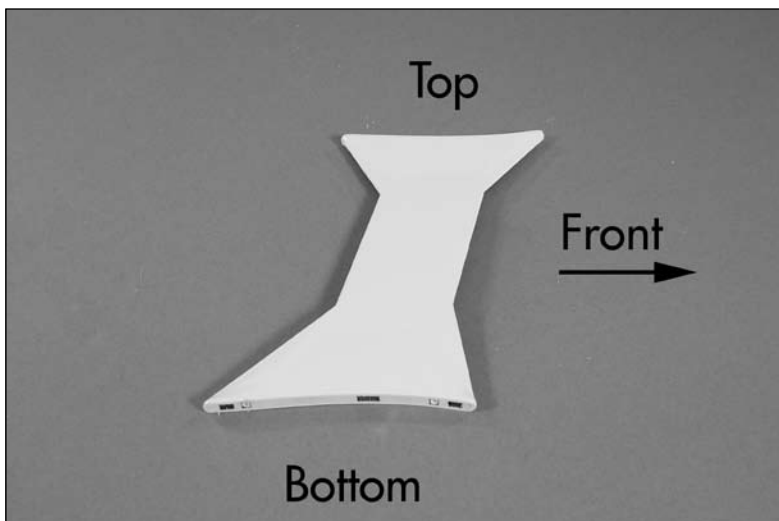

- 5. Use four 2mm x 20mm machine screws and a #1 Phillips screwdriver to attach the interplane struts to the bottom wing. Install the bottom wing to the fuselage at this time.

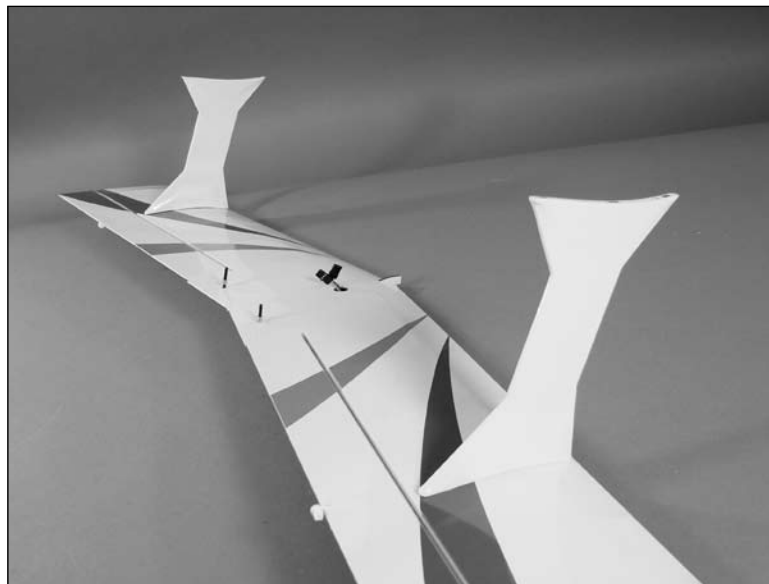

- 6. With the bottom wing installed, attach the top wing to the cabane struts using four 2mm washers, two 2mm nuts and two 2mm x 10mm machine screws. Use a small adjustable wrench and a #1 Phillips screwdriver to secure the screws.

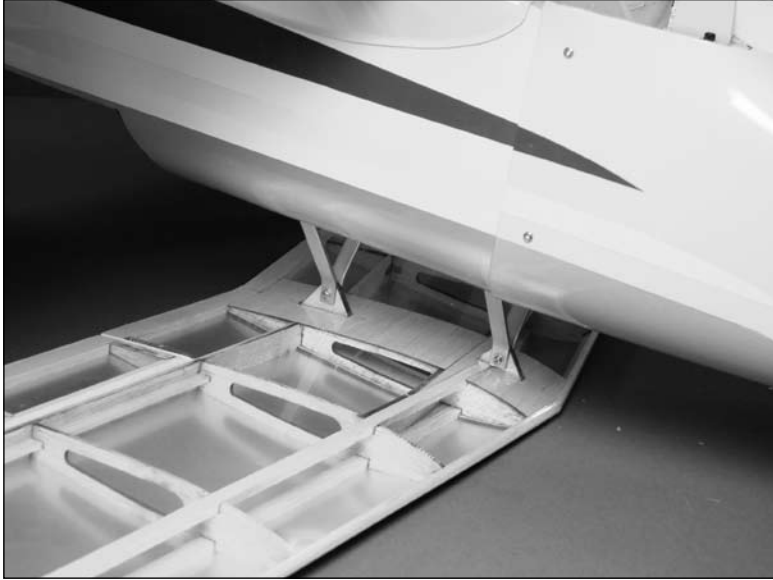

- 7. Use four 2mm x 20mm machine screws and a #1 Phillips screwdriver to secure the interplane struts to the top wing as you did on the bottom wing.

- 8. After sliding a clevis retainer onto the clevis of the 7.5-inch (190mm) linkage, slide the linkage through the pushrod connector.



- 9. Attach the clevis to the interconnect horn of the top wing and slide the clevis retainer onto the clevis.



- ○ 10. Position both ailerons in their neutral positions. Use a 2mm x 6mm machine screw and #1 Phillips screwdriver to secure the linkage.



- 11. Repeat Steps 8 through 10 to connect the remaining top and bottom ailerons.

## Control Throws

- 1. Turn on the transmitter and receiver of your Ultimate 20-300. Check the movement of the rudder using the transmitter. When the stick is moved right, the rudder should also move right. Reverse the direction of the servo at the transmitter if necessary.
- 2. Check the movement of the elevator with the radio system. Moving the elevator stick down will make the airplane elevator move up.
- 3. Check the movement of the ailerons with the radio system. Moving the aileron stick right will make the right aileron move up and the left aileron move down.
- 4. Use a ruler to adjust the throw of the elevator, ailerons and rudder. Adjust the position of the pushrod at the control horn to achieve the following measurements when moving the sticks to their endpoints.

One of the most important things to making a precision type airplane fly and feel right is the servo and linkage set up. With the Ultimate 20-300, as with any high performance airplane, it very important that the radio, servo and linkage set up be optimized to its full extent. This will ensure that you get the proper travel, resolution, precision and torque out of the servo. The steps that follow will guide you to a proper and more precise flying Ultimate 20-300.

The setup for each airplane will differ slightly but here are the major things that you will want to pay close attention to.

### **Servo Arm Length**

You do NOT want the pushrod as far out on the servo arms as you can get it. Place the pushrod in the servo arm at the nearest hole to the center of the servo that will still achieve full travel of the surface without binding or running the pushrod over center.



## Control Horn Length

This length is also very critical. The closer the pushrod attachment is to the surface the LESS mechanical advantage you have on the surface.

In the case of the Ultimate these lengths have been set for you. In general, practice never set the control horn any shorter than it needs to be for the surface to have full deflection at the servo's full travel.

## Travel Adjust

The travel volume of the servo is not only controlling how far the servo travels. It also has a large impact on the resolution of the servo. On any precision/3D airplane you want to keep the travel adjust percentage at 100% minimum. However, it is more optimal to have the final throws of your servo to be set around 125–135%. This will increase the resolution and torque delivered to the surface and improve the feel of any airplane.

To set up the Ultimate properly when using the Spektrum DSP75 digital servos, it will be necessary to use the Spektrum Digital Servo Programmer (SPMDSP). This programmer allows you to increase and optimize the maximum allowable travel of the servo (the stock programming of the servo does not allow for enough travel, even when 150% ATV is used).

Please follow the steps that follow to achieve the correct and optimum servo and linkage setup for Ultimate 20-300.

**Note:** The correct servo arm lengths and control surface travels are listed below these steps.

- 1. Set the nylon screw lock connector at the correct position/length on the servo arm according to the measurements on the next page.
  - 2. Attach the pushrod and clevis to the outer-most hole on the control horn.
  - 3. Center the servo and attach the servo arm so it is parallel to the hinge line.
  - 4. Insert the pushrod into the screw lock connector. Center the control surface and tighten the screw down to hold the pushrod in place.
  - 5. Connect a battery and servo to the programmer.
  - 6. Use the programmer (according to the instructions included with the programmer) to set the center and end point travel of each servo. Use the measurements listed for the throws set by the programmer
- Note:** You are not setting the full and final control throws/deflections at this time. The full control throws/deflections will be adjusted by the use of the travel adjustment in your radio in the next step because there is a difference in the amount of travel achieved with the programmer and transmitter.
- 7. Now plug each servo into the receiver and use the travel adjust function of radio to increase the travel of the servos to the final control throws/deflections. This will allow you to raise the travel adjust percentage in your radio to the suggested 125–135%.

## Programmer Servo Throws

### Ailerons

Up	11/16-inch (16mm)
Down	9/16-inch (13mm)

### Elevator

Up	2-inch (50mm)
Down	2-inch (50mm)

### Rudder

Up	2 <sup>3</sup> / <sub>4</sub> -inch (70mm)
Down	2 <sup>3</sup> / <sub>4</sub> -inch (70mm)

## Final Control Throws

<b>Ailerons</b>	<b>High Rate</b>		<b>Low Rate</b>
Up	7/8-inch (22mm)	Up	5/8-inch (16mm)
Down	3/4-inch (19mm)	Down	1/2-inch (20mm)
	35% Expo		20% Expo
<b>Elevator</b>	<b>High Rate</b>		<b>Low Rate</b>
Up	2 <sup>1</sup> / <sub>4</sub> -inch (57mm)	Up	1 <sup>3</sup> / <sub>4</sub> -inch (44mm)
Down	2 <sup>1</sup> / <sub>4</sub> -inch (57mm)	Down	1 <sup>3</sup> / <sub>4</sub> -inch (44mm)
	35% Expo		20% Expo
<b>Rudder</b>	<b>High Rate</b>		<b>Low Rate</b>
Up	3-inch (76mm)	Up	2-inch (50mm)
Down	3-inch (76mm)	Down	2-inch (50mm)
	38% Expo		25% Expo

**Note:** Measurements are taken at the widest point on the surface.

These are general guidelines measured from our own flight tests. You can experiment with higher rates to match your preferred style of flying.

## Center of Gravity

An important part of preparing the aircraft for flight is properly balancing the model.

**Caution: Do not inadvertently skip this step!**

The recommended Center of Gravity (CG) location for the Ultimate 20-300 is  $3\frac{1}{8}$ – $3\frac{1}{2}$ -inch (80–90mm) back from the leading edge of the top wing. Mark the location for the Center of Gravity on the bottom of the top wing in the center as shown.

When balancing your Ultimate 20-300, support the plane upright at the marks made on the bottom of the wing with your fingers or a commercially available balancing stand. Move the speed control and/or receiver as necessary so the model hangs level or slightly nose down. This is the correct balance point for your model.

Use the  $3\frac{1}{8}$ -inch (80mm) CG for sport/scale flying and the  $3\frac{1}{2}$ -inch (90mm) CG for aerobatic flying.

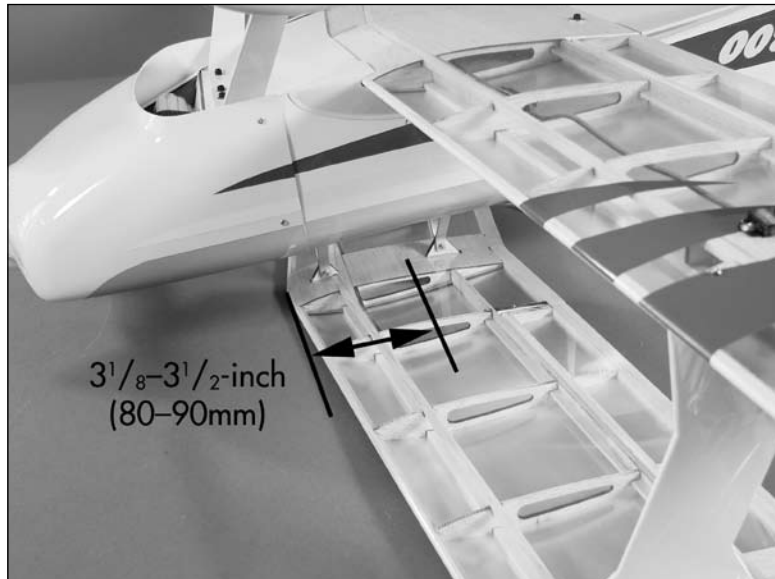

After the first flights, the CG position can be adjusted for your personal preference.

## Preflight

### Check Your Radio

Before going to the field, be sure that your batteries are fully charged per the instructions included with your radio. Charge both the transmitter and receiver pack for your airplane. Use the recommended charger supplied with your particular radio system, following the instructions provided with the radio. In most cases, the radio should be charged the night before going out flying.

Before each flying session, be sure to range check your radio. See your radio manual for the recommended range and instructions for your radio system. Each radio manufacturer specifies different procedures for their radio systems. Next, start the motor. With the model securely anchored, check the range again. The range test should not be significantly affected. If it is, don't attempt to fly! Have your radio equipment checked out by the manufacturer.

**Note:** Keep loose items that can get entangled in the propeller away from the prop. These include loose clothing, or other objects such as pencils and screwdrivers. Especially keep your hands away from the propeller.

Double-check that all controls (aileron, elevator, rudder and throttle) move in the correct direction.

Check the radio installation and make sure all the control surfaces are moving correctly (i.e. the correct direction and with the recommended throws). Test run the motor and make sure it transitions smoothly from off to full throttle and back. Also ensure the engine is installed according to the manufacturer's instructions, and it will operate consistently.

Check all the control horns, servo horns, and clevises to make sure they are secure and in good condition. Replace any items that would be considered questionable. Failure of any of these components in flight would mean the loss of your aircraft.

## Range Test Your Radio

---

- 1. Before each flying session, be sure to range check your radio. This is accomplished by turning on your transmitter with the antenna collapsed. Turn on the receiver in your airplane. With your airplane on the ground and the engine running, you should be able to walk 30 paces (approximately 100 feet) away from your airplane and still have complete control of all functions.

If not, don't attempt to fly! Have your radio equipment checked out by the manufacturer.

- 2. Double-check that all controls (aileron, elevator, rudder and throttle) move in the correct direction.
- 3. Be sure that your transmitter batteries are fully charged, per the instructions included with your radio.

## Flying Your Ultimate 20-300

---

Flying the Ultimate 20-300 is a pleasure. Takeoffs are easy as well as landings. We hope you enjoy flying your Ultimate 20-300 as much as we do.

Happy Landings!

## Instructions for Disposal of WEEE by Users in the European Union

---

This product must not be disposed of with other waste. Instead, it is the user's responsibility to dispose of their waste equipment by handing it over to a designated collection point for the recycling of waste electrical and electronic equipment. The separate collection and recycling of your waste equipment at the time of disposal will help to conserve natural resources and ensure that it is recycled in a manner that protects human health and the environment. For more information about where you can drop off your waste equipment for recycling, please contact your local city office, your household waste disposal service or where you purchased the product.



# 2008 Official AMA National Model Aircraft Safety Code

---

## GENERAL

- 1) I will not fly my model aircraft in sanctioned events, air shows or model flying demonstrations until it has been proven to be airworthy by having been previously, successfully flight tested.
- 2) I will not fly my model higher than approximately 400 feet within 3 miles of an airport without notifying the airport operator. I will give right-of-way and avoid flying in the proximity of full-scale aircraft. Where necessary, an observer shall be utilized to supervise flying to avoid having models fly in the proximity of full-scale aircraft.
- 3) Where established, I will abide by the safety rules for the flying site I use, and I will not willfully or deliberately fly my models in a careless, reckless and/or dangerous manner.
- 4) The maximum takeoff weight of a model is 55 pounds, except models flown under Experimental Aircraft rules.
- 5) I will not fly my model unless it is identified with my name and address or AMA number on or in the model. (This does not apply to models while being flown indoors.)
- 6) I will not operate models with metal-bladed propellers or with gaseous boosts, in which gases other than air enter their internal combustion engine(s); nor will I operate models with extremely hazardous fuels such as those containing tetranitromethane or hydrazine.

## RADIO CONTROL

- 1) I will have completed a successful radio equipment ground range check before the first flight of a new or repaired model.
- 2) I will not fly my model aircraft in the presence of spectators until I become a qualified flier, unless assisted by an experienced helper.
- 3) At all flying sites a straight or curved line(s) must be established in front of which all flying takes place with the other side for spectators. Only personnel involved with flying the aircraft are allowed at or in front of the flight line. Intentional flying behind the flight line is prohibited.

- 4) I will operate my model using only radio control frequencies currently allowed by the Federal Communications Commission. (Only properly licensed Amateurs are authorized to operate equipment on Amateur Band frequencies.)
- 5) Flying sites separated by three miles or more are considered safe from site-to-site interference, even when both sites use the same frequencies. Any circumstances under three miles separation require a frequency management arrangement, which may be either an allocation of specific frequencies for each site or testing to determine that freedom from interference exists. Allocation plans or interference test reports shall be signed by the parties involved and provided to AMA Headquarters.

Documents of agreement and reports may exist between (1) two or more AMA Chartered Clubs, (2) AMA clubs and individual AMA members not associated with AMA Clubs, or (3) two or more individual AMA members.

- 6) For Combat, distance between combat engagement line and spectator line will be 500 feet per cubic inch of engine displacement. (Example: .40 engine = 200 feet.); electric motors will be based on equivalent combustion engine size. Additional safety requirements will be per the RC Combat section of the current Competition Regulations.
- 7) At air shows or model flying demonstrations, a single straight line must be established, one side of which is for flying, with the other side for spectators.
- 8) With the exception of events flown under AMA Competition rules, after launch, except for pilots or helpers being used, no powered model may be flown closer than 25 feet to any person.
- 9) Under no circumstances may a pilot or other person touch a powered model in flight.







© 2008 Horizon Hobby, Inc.  
4105 Fieldstone Road  
Champaign, Illinois 61822  
(877) 504-0233  
[horizonhobby.com](http://horizonhobby.com)  
[E-fliteRC.com](http://E-fliteRC.com)