

Aeronca Champ 15e ARF

Assembly Manual



Notice

All instructions, warranties and other collateral documents are subject to change at the sole discretion of Horizon Hobby, Inc. For up-to-date product literature, visit <http://www.horizonhobby.com> and click on the support tab for this product.

Meaning of Special Language

The following terms are used throughout the product literature to indicate various levels of potential harm when operating this product:

NOTICE: Procedures, which if not properly followed, create a possibility of physical property damage AND a little or no possibility of injury.

CAUTION: Procedures, which if not properly followed, create the probability of physical property damage AND a possibility of serious injury.

WARNING: Procedures, which if not properly followed, create the probability of property damage, collateral damage, and serious injury OR create a high probability of superficial injury.

 **WARNING:** Read the ENTIRE instruction manual to become familiar with the features of the product before operating. Failure to operate the product correctly can result in damage to the product, personal property and cause serious injury.

This is a sophisticated hobby product and NOT a toy. It must be operated with caution and common sense and requires some basic mechanical ability. Failure to operate this Product in a safe and responsible manner could result in injury or damage to the product or other property. This product is not intended for use by children without direct adult supervision. Do not attempt disassembly, use with incompatible components or augment product in any way without the approval of Horizon Hobby, Inc. This manual contains instructions for safety, operation and maintenance. It is essential to read and follow all the instructions and warnings in the manual, prior to assembly, setup or use, in order to operate correctly and avoid damage or serious injury.

Table of Contents

Notice	2
Meaning of Special Language.....	2
Introduction	2
Important Information Regarding Warranty Information	2
Specifications.....	2
Using the Manual.....	3
Contents of Kit/Parts Layout.....	3
Covering Colors.....	3
Hardware/Accessory Sizes.....	3
Recommended Radio Equipment	3
Power 15 Motor Setup	3
Optional Accessories.....	3
Required Tools and Adhesives	3
Warnings	3
Aileron Servo Installation.....	4
Landing Gear Installation.....	9
Motor and Speed Control Installation	11
Rudder and Elevator Installation	14
Rudder and Elevator Servo Installation.....	17
Tail Wheel Installation	21
Receiver Installation.....	22
Window Installation	24
Wing Installation.....	25
Tail Rigging Installation.....	28
Battery Installation and Center of Gravity.....	30
Control Throws.....	31
Preflight.....	31
Flying Your Aeronca Champ 15e ARF	32
Range Test Your Radio	32
Safety Do's and Don'ts for Pilots.....	32
Daily Flight Checks.....	32
Warranty and Repair Policy.....	33
Warranty Services.....	33
Compliance Information for the European Union	34
2010 Official Academy of Model Aeronautics Safety Code	34

Introduction

Designed as an answer to Piper's J-3 Cub, the Aeronca 7AC Champion has been winning the hearts of pilots since 1944. Its honest, easy-going flight characteristics just seem to have a way of soothing the nerves and restoring the soul of everyone who flies it.

Now modelers can experience the Champ's winning ways in stunning scale detail with the E-flite® Aeronca Champ 15e. In addition to its near-perfect scale outline, this Platinum Series ARF comes out of the box with many other details, most of which have been completed for you. Some of these include a classic Champ trim scheme, instrument panel details, a painted fiberglass cowl with simulated exhausts and scale shock absorbing landing gear. E-flite has even gone so far as to construct the airframe as close as possible to the full-scale version.

If you love general aviation classics, but don't really feel like spending a lot of time building one, the E-flite Aeronca Champ 15e is just the scale stick-and-rudder fix you've been waiting for.

Important Information Regarding Warranty Information

Please read our Warranty and Liability Limitations section on Page 33 before building this product. If you as the Purchaser or user are not prepared to accept the liability associated with the use of this Product, you are advised to return this Product immediately in new and unused condition to the place of purchase.

Specifications

Wingspan:	60.0 in (1530mm)
Length:	37.6 in (955mm)
Wing Area:	499 sq in (32.2 sq dm)
Weight w/o Battery:	2.80–2.95 lb (1.25–1.35 kg)
Weight with Battery:	3.30–3.65 lb (1.50–1.65 kg)

Using the Manual

This manual is divided into sections to help make assembly easier to understand, and to provide breaks between each major section. In addition, check boxes have been placed next to each step to keep track of its completion. Steps with a single circle (○) are performed once, while steps with two circles (○○) indicate the step will require repeating, such as for a right or left wing panel, two servos, etc.

Remember to take your time and follow the directions.

Contents of Kit/Parts Layout

Replacement Parts

EFL280001	Fuselage
EFL280002	Wing Panels (left and right)
EFL280003	Tail Set
EFL280004	Landing Gear
EFL280005	Cowling
EFL280006	Main Wheel Set
EFL280007	Windshields
EFL280008	Hardware
EFL280009	Pushrods
EFL280010	Main Struts
EFL280011	Wing Tube
EFL280012	Tail Wheel Assmembly



Covering Colors

Orange	HANU877
Cub Yellow	HANU884

Hardware/Accessory Sizes

Main wheel diameter	2 ¹ / ₂ -inch (63mm)
Tail wheel diameter	1-inch (25mm)

Recommended Radio Equipment

You will need a minimum 4-channel transmitter, receiver and four servos. You can choose to purchase a complete radio system. If you are using an existing transmitter, just purchase the other required equipment separately. We recommend the crystal-free, interference-free Spektrum™ DX6i 2.4GHz DSM® 6-channel system. If using your own transmitter, we recommend the following radio equipment.

If you own the Spektrum DX6i radio, or you are using a different DSM2 radio, just add the AR6200 DSM2™ 6-channel receiver and four JR SPORT™ MC35 servos.

Complete Radio System

SPM6600 DX6i DSM2 6CH system

Or Purchase Separately

SPMAR6200 AR6200 DSM2 6-Channel Full-Range Receiver
 JSP20030 MC35 Servo (4)
 JSP98110 6-inch (152mm) (2) aileron servo inside wing
 JRPA096 9-inch (228mm) receiver to aileron extension
 JSP98030 12-inch (305mm) receiver to aileron extension
 JSP98060 Large JR Sport Servo Arm

Optional

JSP98020 6-inch (152mm) Y-Harness (Required if not using a computer radio with dual aileron inputs)

Power 15 Motor Setup

EFLM4015A: Power 15 Brushless Outrunner Motor, 950Kv
 EFLA1040L: 40-Amp Lite Pro Switch-Mode BEC Brushless ESC
 EFLB32003S30: 3200mAh 3S 11.1V 30C Li-Po, 12AWG EC3
 APC11070E APC Electric Propeller, 11 x 7E

Optional Accessories

EFLA110 Power Meter
 EFLC505 Intelligent 1- to 5-Cell Balancing Charger
 EFLAEC312 Charge Lead with 12-inch Wire and Jacks, 16AWG
 EFLA151 Civilian Pilot, Blue

Required Tools and Adhesives

Tools & Equipment

Balancing stand	Card stock
Clamps	Drill
Felt-tipped pen	Hemostat
Low-tack tape	Mixing cup
Mixing stick	Needle nose pliers
Paper towels	Pencil
Pin vise	Phillips screwdriver: #1
Pliers	Razor saw
Rubbing alcohol	Ruler
Sanding block	Scissors
Side cutter	Small flat blade screwdriver
Square	Straightedge
String	Toothpicks
T-pins	Tweezer
Hex wrench: 1.5mm, 3/32-inch	
Hobby knife with #11 blade	
Drill bit: 1/16-inch (1.5mm), 5/64-inch (2mm)	
Nut driver: 4mm, 7mm	

Adhesives

12-minute epoxy	6-minute epoxy
Thin CA	Medium CA
Threadlock	Canopy glue



Warnings

Read and follow all instructions and safety precautions before use. Improper use can result in fire, serious injury and damage to property.

COMPONENTS

Use only with compatible components. Should any compatibility questions exist please refer to the product instructions, the component instructions or contact Horizon Hobby, Inc.

FLIGHT

Fly only in open areas to ensure safety. It is recommended flying be done at AMA (Academy of Model Aeronautics) approved flying sites. Consult local laws and ordinances before choosing a location to fly your aircraft.

PROPELLER

Keep loose items that can get entangled in the propeller away from the prop, including loose clothing, or other objects such as pencils and screwdrivers. Especially keep your hands away from the propeller as injury can occur.

BATTERIES



Notes on Lithium Polymer Batteries

When misused, lithium polymer batteries are significantly more volatile than alkaline or Ni-Cd/Ni-MH batteries used in RC applications. Always follow the manufacturer's instructions when using and disposing of any batteries. Mishandling of Li-Po batteries can result in fire and explosion causing serious injury and damage.

SMALL PARTS

This kit includes small parts and should not be left unattended near children as choking and serious injury could result.

SAFETY PRECAUTIONS

- Check all control surfaces prior to each takeoff.
- Do not fly your model near spectators, parking areas or any other area that could result in injury to people or damage of property.
- Do not fly during adverse weather conditions. Poor visibility can cause disorientation and loss of control of your aircraft. Strong winds can cause similar problems.
- Do not take chances. If at any time during flight you observe any erratic or abnormal operation, land immediately and do not resume flight until the cause of the problem has been ascertained and corrected. Safety can never be taken lightly.
- Do not fly near power lines.

E-tips

During the course of building your Aeronca Champ we suggest you use a soft base for the building surface. Such things as a foam stand, large piece of bedding foam or a thick bath towel will work well and help protect the model from damage during assembly. This is not shown in the instructions to provide the greatest detail in the photos.

Aileron Servo Installation

Required Parts

Wing panel (right and left)	
Transmitter	Receiver
Receiver battery	
Nylon clevis (2)	Silicone clevis retainer (2)
Micro servo (2)	Large servo horn (2)
Servo mounting block, 8mm x 9mm x 12mm (4)	
Aileron linkage wire, 4-inch (102mm) (2)	
Nylon pushrod connector (2)	
2.6mm x 8mm sheet metal screw (4)	
Servo extension, 6-inch (152mm) (2)	

Required Tools and Adhesives

String	Sanding block
Thin CA	Pin vise
Pliers	Clamps
Side cutter	Phillips screwdriver: #1
Ruler	Razor saw
Pencil	Scissors
6-minute epoxy	Mixing cups
Mixing stick	Paper towel
Drill bit: 1/16-inch (1.5mm), 5/64-inch (2mm)	

- 1. Install the servo grommets and brass eyelets following the instructions provided with the servo.

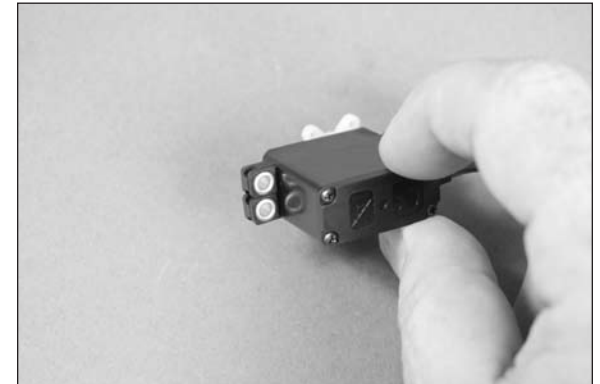

- ○ 2. Connect a 6-inch (152mm) servo extension to the servo lead. Use scissors to cut a 3-inch (76mm) piece of string. Use the string to secure the extension to the servo.

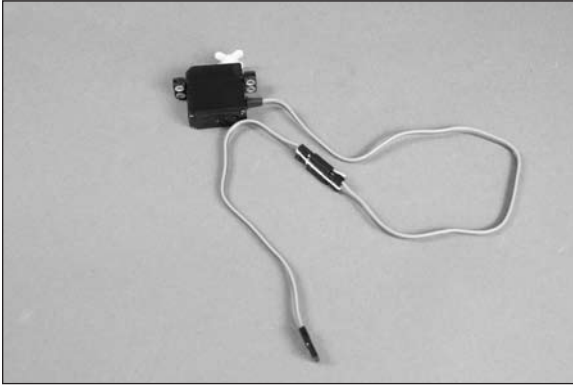

- ○ 3. Remove the servo cover from the wing by lifting the tape toward the leading edge. The cover has a tab at the rear that will keep it in position near the aileron.

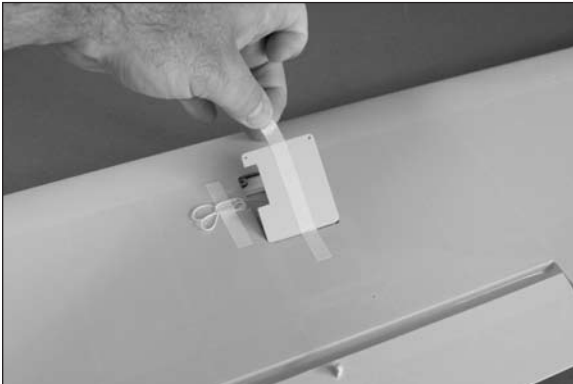

- ○ 4. Use a pencil and ruler to mark the center of the opening in the servo cover for the servo output shaft.

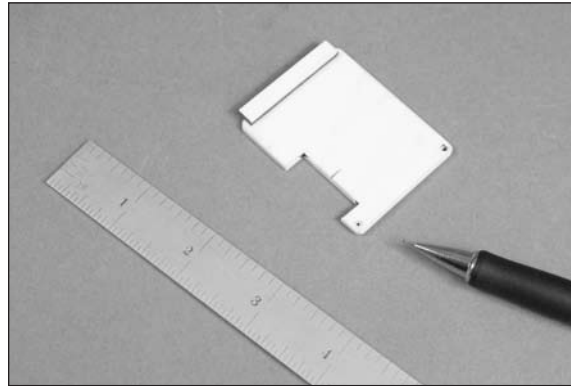

E-tips

Make sure the servo is square on the servo cover before marking the location for the sides of the servo.

- ○ 5. Use a #1 Phillips screwdriver to remove the servo horn from the servo. Position the servo so the servo output is centered on the mark made in the previous step. Use a pencil to transfer the edges along the sides of the servo on the servo cover.

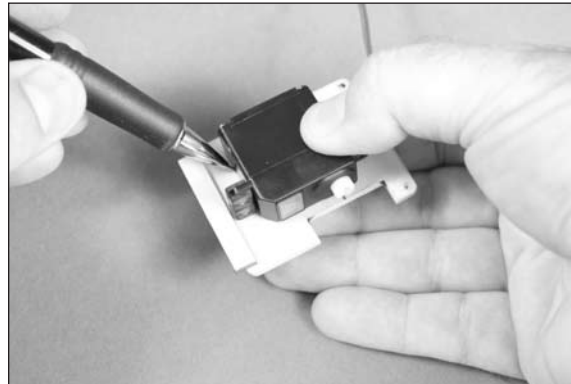

E-tips

If you are using a computer radio, select an unused model memory to begin the setup of your model. It is highly recommended to reset the model memory to make sure the programming is set to the default settings. If you are using a 2.4GHz radio system, you will need to bind the transmitter and receiver at this time.

- ○ 6. Plug the servo into the receiver. Center the stick and trim on the transmitter for the ailerons. Use the transmitter and receiver to center the aileron servo. Place a large servo horn on the servo so it is perpendicular to the servo centerline. Use a #1 Phillips screwdriver to secure the servo horn to the servo.

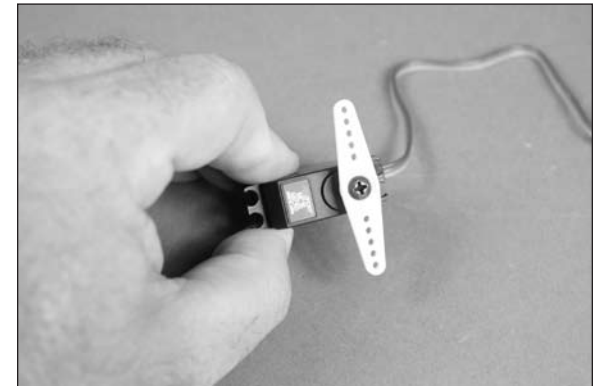

- 7. Position the servo on the cover, using the lines drawn in Step 5. Adjust the position of the servo so the servo horn is positioned center in the opening as shown.

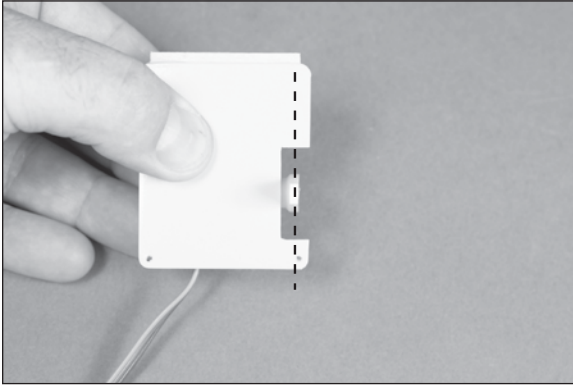

- 8. Use a pencil to mark the position of the servo next to the brass eyelets. Make sure not to move the servo when marking the servo cover.

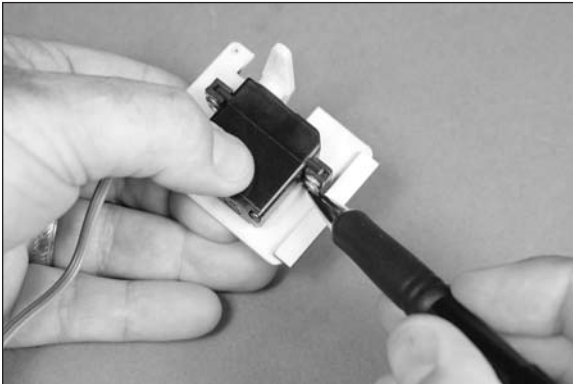

- 9. Position the block on the cover near the rear of the cover. It will be necessary to notch the block to fit over the tab that secures the rear of the cover. Position the block against the tab and use a pencil to draw a line on the block to determine how much to remove.

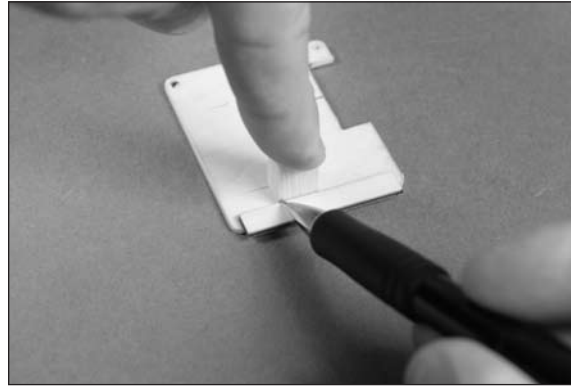

- 10. With the block positioned on the marks made for the servo, use a pencil to mark the block for the amount required to be removed so it can fit over the tab.



- 11. Use a sanding block or razor saw to remove the material necessary from the block to fit over the tab when the block is positioned on the cover for mounting the servo.

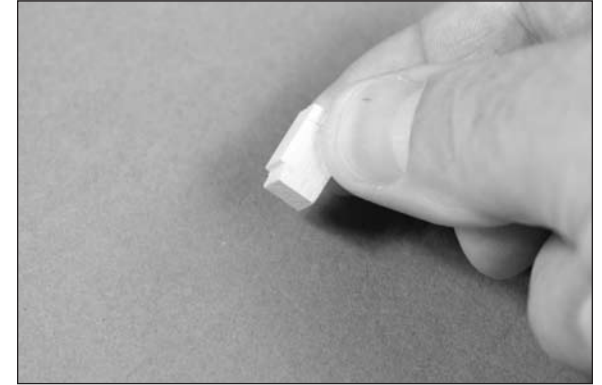

- 12. Use 6-minute epoxy to glue the servo blocks to the servo cover. Use clamps to hold the blocks in position until the glue fully cures.

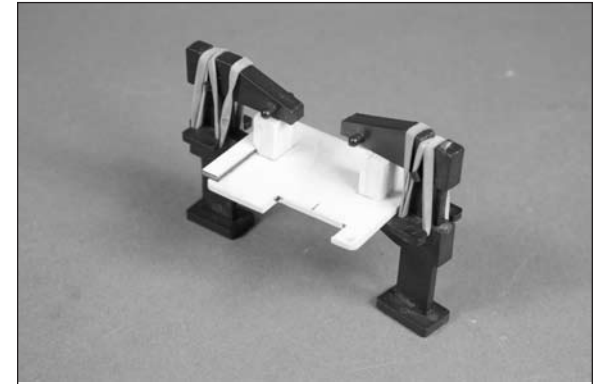

- 13. Position the servo between the servo mounting blocks. Use a pencil to mark the block against the servo lead so it can be trimmed to provide clearance for the servo lead.

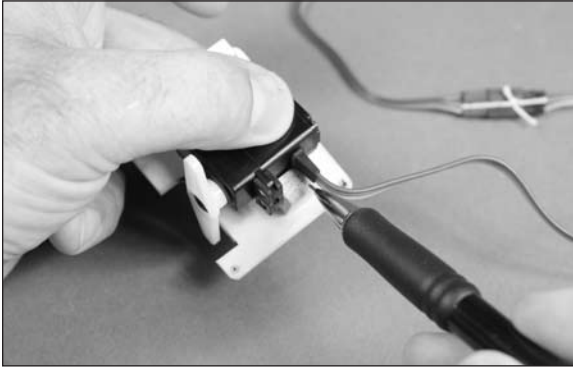

- 14. Use a razor saw and sanding block to trim the servo mounting block to allow clearance for the servo lead.

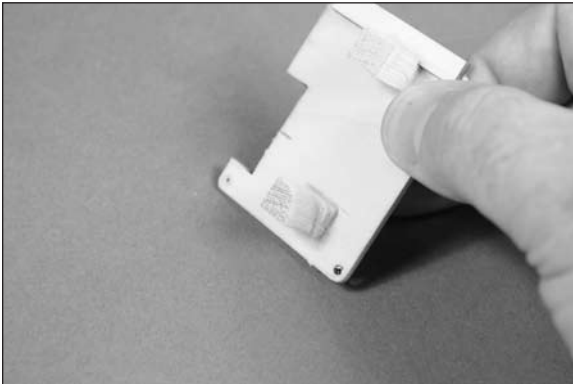

- 15. Apply thin CA to the top of each servo mounting block. The wood fibers will soak in the CA, which will help prevent the blocks from splitting when they are drilled for the servo mounting screws.

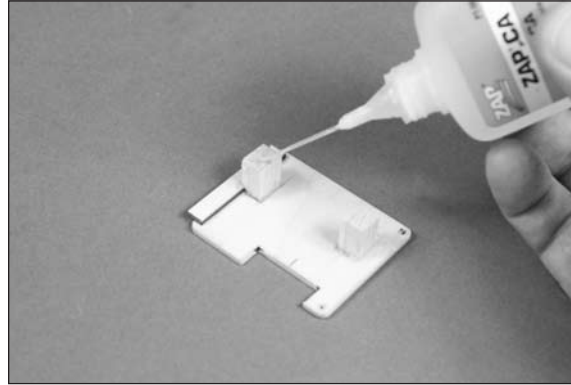

- 16. Position the servo between the blocks. Position the servo so there is a small gap of 1/64-inch (.5mm) between the servo cover and servo to prevent the transfer of vibration from the airframe into the servo. Use a pencil to mark the locations on the servo mounting blocks for the servo mounting screws.



- 17. Use a pin vise and 1/16-inch (1.5mm) drill bit to drill the holes in the servo mounting blocks for the servo mounting screws.

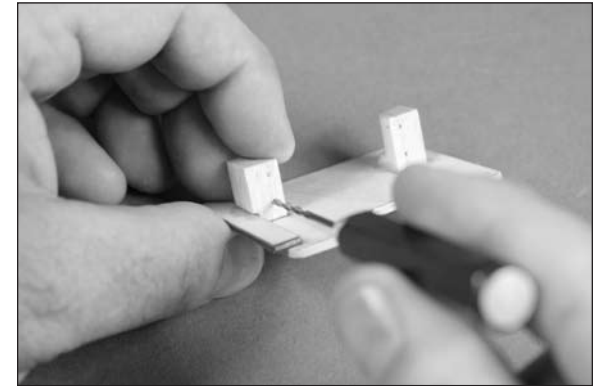

- 18. Apply 2–3 drops of thin CA in each hole to harden the surrounding wood. This will help keep the screws from vibrating loose.

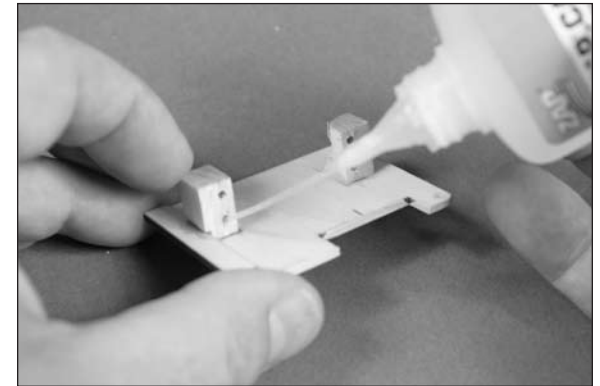

- ○ 19. Use a #1 Phillips screwdriver and the screws provided with the servo to secure it to the servo mounting blocks. Use side cutters to remove the unused arm from the servo horn so it does not interfere with the operation of the servo.

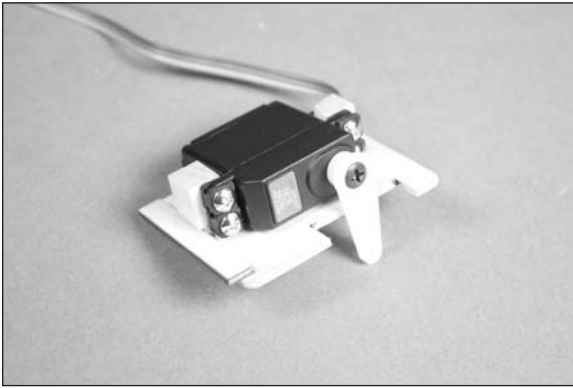

- ○ 20. Use a pin vise and 5/64-inch (2mm) drill bit to enlarge the hole on the servo horn that is 11/16-inch (17.5mm) from the center of the servo horn.

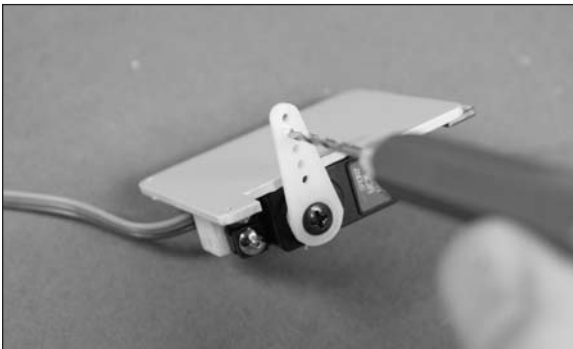

- ○ 21. Tie the end of the string in the servo opening to the end of the servo extension.



- ○ 21. Use the string to pull the servo lead and extension through the wing and out at the wing root as shown.

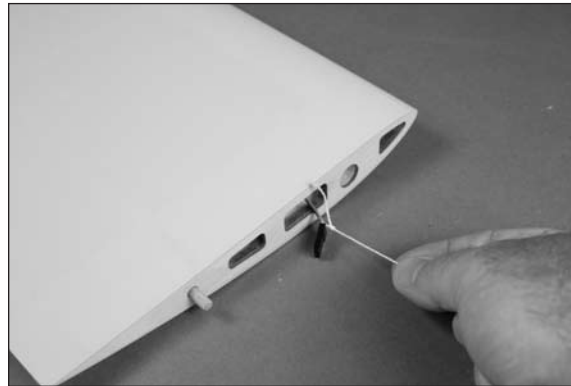

Etips

Leave a short 2-inch (52mm) piece of the string tied to the aileron extension, just in case it happens to fall into the wing accidentally.

- ○ 22. Place the servo cover in position in the servo opening. Use a #1 Phillips screwdriver and two 2.6mm x 8mm sheet metal screws to secure the cover to the wing.



- ○ 23. Insert the 4-inch (102mm) pushrod wire into the hole in the servo horn enlarged in Step 20. Use a nylon pushrod connector to secure the pushrod to the servo horn. You may need to use pliers to snap the connector over the wire.



- ○ 24. Slide a silicone clevis retainer over a nylon clevis. Remove the tape holding the aileron centered to the wing. This is clear tape from the factory so it might be difficult to see. Connect the aileron servo to the receiver and use the radio system to keep the aileron servo centered. Thread the clevis on the pushrod wire and connect the clevis to the aileron control horn. Adjust the clevis so the aileron is aligned with the wing while the aileron servo is centered. Slide the silicone clevis retainer over the forks of the clevis to keep it from opening in flight.



- ○ 25. Repeat Steps 1 through 24 to install the remaining aileron servo and linkage.
- ○ 26. If you have not done so, turn off the transmitter and remove the power from the receiver.

Landing Gear Installation

Required Parts

Fuselage Landing gear strut (2)
 2mm locknut (6) 4mm locknut (2)
 Side landing gear mount (4)
 Bottom landing gear mount
 2mm washer (12)
 2mm x 12mm machine screw (6)
 2.6mm x 10mm sheet metal screw (2)
 3mm x 8mm machine screw (4)
 Wheel collar (4mm) with setscrew (2)
 Wheel with brass spacer, 2¹/₂-inch (63mm) (2)

Required Tools and Adhesives

Nut driver: 7mm Ruler
 Hemostat Threadlock
 Small flat blade screwdriver
 Phillips screwdriver: #1
 Hex wrench: 1.5mm

- 1. Remove the tape holding the front windscreen on the fuselage. Remove the windscreen and set it aside until it is time to glue it into position.

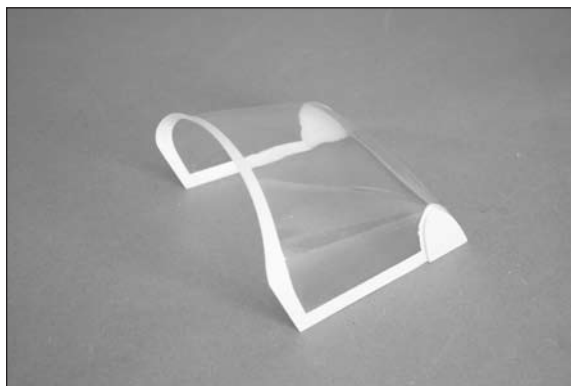

E-tips

Make sure to use threadlock on all metal-to-metal fasteners so they don't vibrate loose.

- 2. Use a #1 Phillips screwdriver to tighten the 3mm x 8mm machine screws that attach the four side landing gear mounts to the fuselage. There are two mounts on the right and two on the left side of the fuselage.



- 3. Attach the bottom landing gear mount to the bottom of the fuselage using two 2.6mm x 10mm sheet metal screws. Use a #1 Phillips screwdriver to tighten the screws.



- 4. Attach the landing gear strut to the side landing gear mount using two 2mm x 12mm machine screws and two 2mm locknuts. Make sure to place a 2mm washer on the screw, one under the head of the screw and one between the mount and locknut. Tighten the front screw, but not so tight as to bind the movement of the gear. The rear only needs to be in position, as it will be removed later to install the wing struts. Use hemostats to hold the locknut while tightening the screw using a #1 Phillips screwdriver.



- 5. Secure the strut leg from the landing gear to the bottom landing gear mount using a 2mm x 12mm machine screw, two 2mm washers and a 2mm locknut. Use hemostats to hold the locknut while tightening the screw using a #1 Phillips screwdriver. Do not over-tighten the screw and cause binding of the landing gear.



E-tips

Make sure to use threadlock on all metal-to-metal fasteners so they don't vibrate loose.

- 6. Install the 4mm wheel collar on the landing gear strut. Position the wheel collar so it is 5/8-inch (16.5mm) from the end of the axle as shown. Use a 1.5mm hex wrench to tighten the setscrew that secures the wheel collar to the axle.

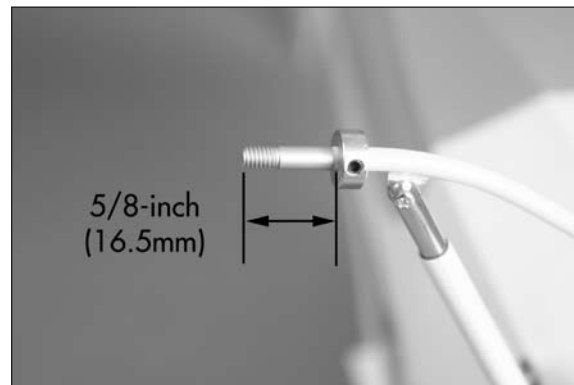

- 7. Use a small flat blade screwdriver to remove the hub cap from the wheel. Work slowly, lifting the hub cap slightly, rotating the wheel to lift the hub cap at different locations around its perimeter.



- 8. There is a brass spacer located inside the wheel. Make sure this spacer is installed in the wheel before placing the wheel on the axle or it will not roll correctly. Slide the wheel on the axle. Use a 4mm locknut and 7mm nut driver to tighten the nut. Do not over-tighten the nut so the wheel can roll freely.



- 9. Place the hub cap back in position to complete the wheel installation.



- 10. Repeat Steps 4 through 9 to install the remaining landing gear strut and wheel.



Motor and Speed Control Installation

Required Parts

Fuselage assembly	Cowling
Propeller	Motor battery (charged)
Speed control	Hook and loop tape
Transmitter	Receiver
#4 washer (4)	Motor with accessories
4-40 x 1/2-inch socket head screw (4)	
2mm x 8mm sheet metal screw (4)	

Required Tools and Adhesives

Low-tack tape	Ruler
Pin vise	Scissors
Card stock	Phillips screwdriver: #1
Thin CA	Hex wrench: 3/32-inch
Threadlock	Drill bit: 1/16-inch (1.5mm)

E-tips

Make sure to use threadlock on all metal-to-metal fasteners so they don't vibrate loose.

- 1. Attach the X-mount to the back of the motor using the screws provided with the motor. Use a #1 Phillips screwdriver to tighten the screws.



E-tips

Make sure to use threadlock on all metal-to-metal fasteners so they don't vibrate loose.

- 2. Attach the motor to the firewall using four 4-40 x 1/2-inch socket head screws and four #4 washers. Use a 3/32-inch hex wrench to tighten the screws.



E-tips

The blind nuts in the firewall can be repositioned for a variety of motors. It may be necessary to move them for your particular motor installation.

- 3. Remove the battery/radio cover from the bottom of the fuselage by pulling the catch rearward and lifting the front of the hatch. The rear is held in place using a tab.

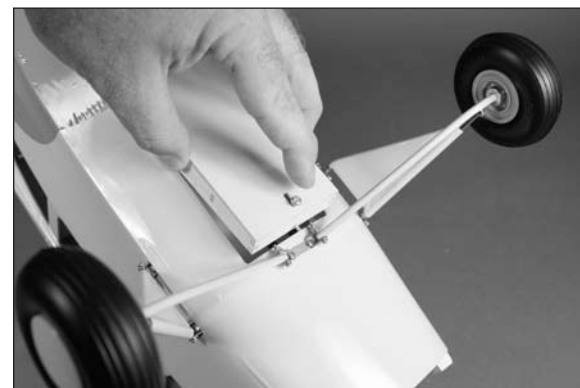

- 4. Connect the leads from the motor to the motor leads on the speed control.

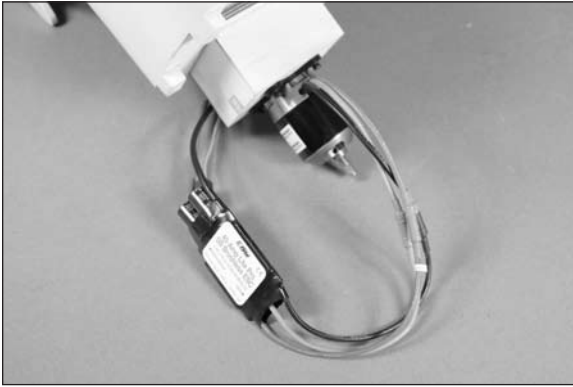

E-tips

Matching the colors between the ESC and motor when they are connected results in the correct motor direction if using all E-flite components.

- 5. Use scissors to cut a 1½-inch (38mm) piece of hook and loop tape. Remove the backing and apply the tape to the speed control.

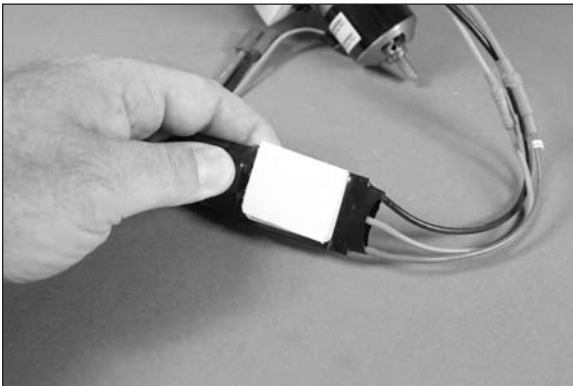

- 6. Insert the speed control into the opening in the front of the fuselage. Use the hook and loop tape to secure the speed control inside the fuselage.

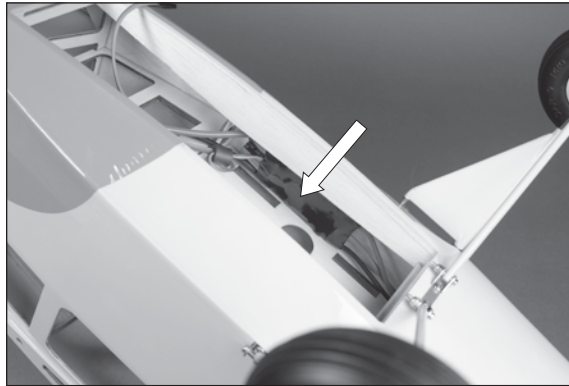

- 7. Using the motor battery, receiver and transmitter, check the operation of the motor. If connected correctly, it will spin counterclockwise when viewed from the front of the fuselage. If not, reverse any two wires between the motor and speed control to correct the direction of rotation of the motor. Disconnect the receiver and turn off the transmitter and receiver and set them aside.

- 8. Cut four 1/2 x 2-inch (13mm x 52mm) pieces of card stock. Use low-tack tape to tape the card stock on the fuselage to locate the cowl mounting blocks.

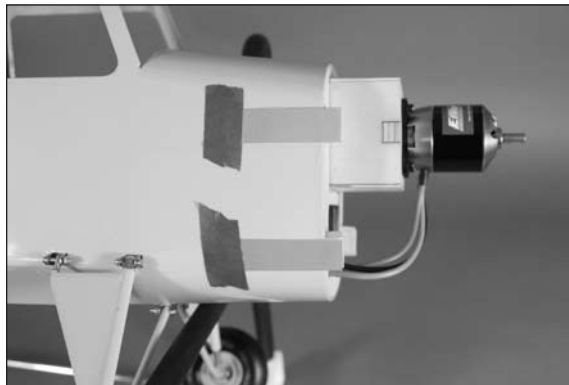

- 9. Slide the cowl in position on the front of the fuselage. Make sure the card stock is on the outside of the cowl.

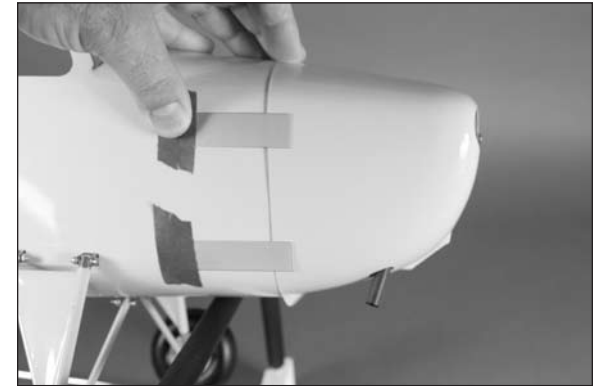

- 10. Slide the propeller adapter in position on the motor shaft. Slide the cowl rearward so the propeller adapter can rotate without rubbing on the cowl. Align the cowl so the propeller adapter is centered in the opening. Use low-tack tape to hold the cowl on the fuselage.



- 11. Use a pin vise and 1/16-inch (1.5mm) drill bit to drill the four holes for the cowl mounting screws. Use the card stock in locating these screws.



- 12. Remove the propeller adapter, cowling, card stock and tape from the fuselage. Apply 2-3 drops of thin CA in each of the holes drilled to harden the surrounding wood. This will help prevent the screws from vibrating loose in flight.



- 13. Use four 2mm x 8mm sheet metal screws to secure the cowling to the fuselage. Tighten the screws using a #1 Phillips screwdriver.



E-tips

Always balance your propeller. An unbalanced propeller can cause vibrations to be transmitted into the airframe, which could damage the airframe or other components as well as produce unwanted flight characteristics.

- 14. Slide the propeller on the propeller adapter. It may be necessary to enlarge the hole in the propeller slightly to fit the adapter.

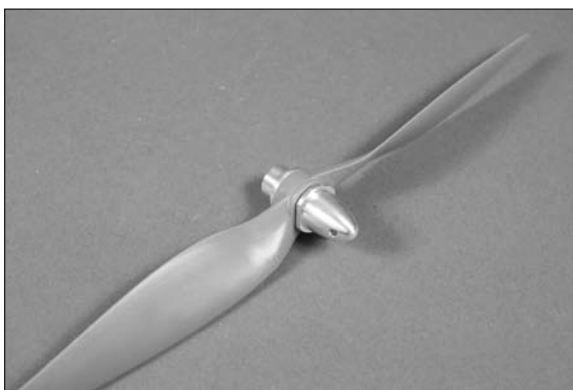

- 15. Slide the propeller assembly on the motor shaft. Use a 3/32-inch hex wrench to tighten the adapter nut, securing the propeller assembly to the motor shaft.



E-tips

If you find the adapter rubbing on the cowling, use a pin vise and 5/64-inch (2mm) drill bit to enlarge the holes in the cowling. This will allow some adjustment to reposition the cowling on the fuselage.

Rudder and Elevator Installation

Required Parts

Fuselage assembly Rudder
Stabilizer/elevator assembly (2)
CA hinge (3)

Required Tools and Adhesives

Square	Ruler or straightedge
12-minute epoxy	Mixing cup
Mixing stick	T-pins
Rubbing alcohol	Paper towels
Toothpicks	Low-tack tape
Thin CA	

- 1. Gently pull on the stabilizer and elevator to check that the hinges are glued securely. If you find any loose hinges, apply thin CA to the hinge to secure its location.



- 2. Flex the control surface through its range of motion a number of times to break in the hinges.

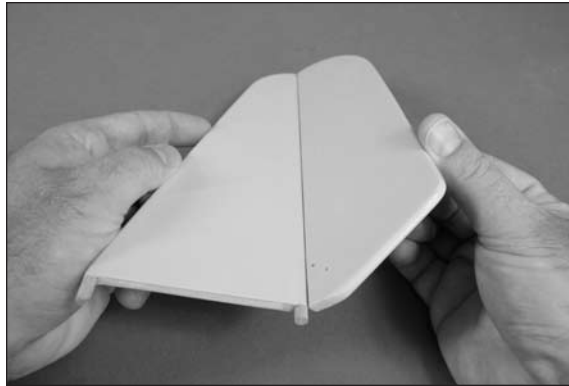
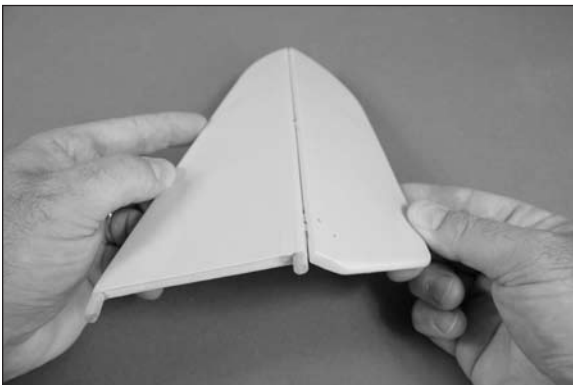

Etips

Read through the steps on installing the stabilizers. The alignment must be as accurate as possible, so we suggest fitting these components BEFORE mixing any epoxy.

- 3. Fit the stabilizer into the tubes in the fuselage. It will fit with a little play, which is normal. Both stabilizers are the same so there is not a left or right.

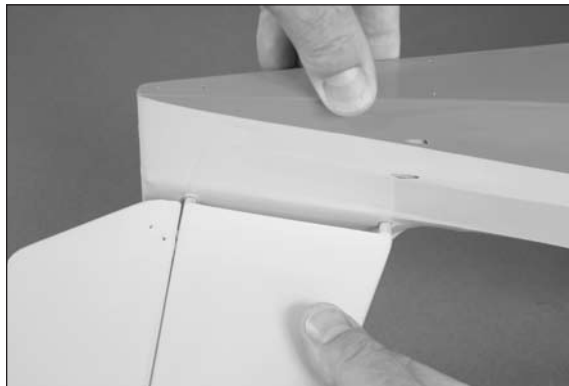

- 4. Slide the stabilizer tight against the fuselage.

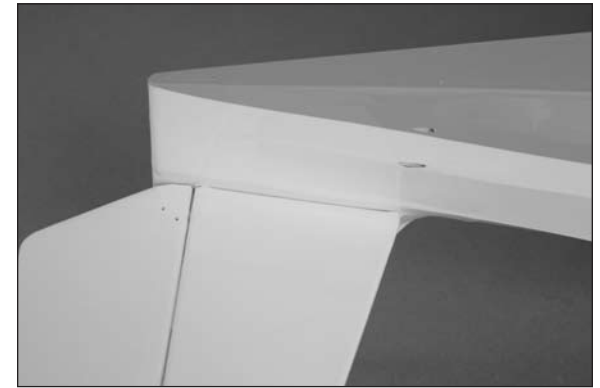

- 5. Repeat Steps 3 and 4 to position the remaining stabilizer. The dowels from the right and left stabilizer will fit against each other in the stabilizer tubes in the fuselage.



- 6. Use a straight edge to check that the hinge lines between the right and left stabilizer are aligned with each other. You won't be able to fit the straight edge right to the hinge line, but you can measure from the hinge line to the straight edge for alignment.

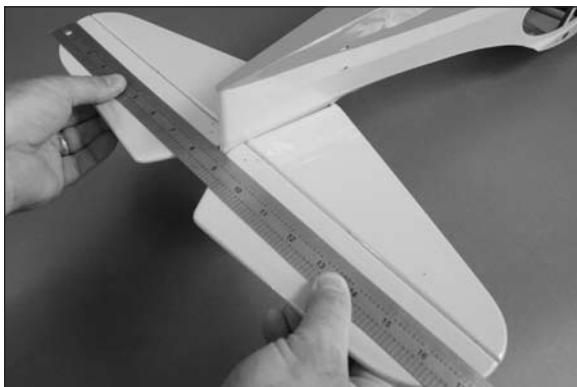

- 7. Use a straight edge to check that the stabilizers are parallel with each other as well. Although this can be corrected slightly when installing the tail bracing, it is best to try and set this alignment as close as possible at this time.



- 8. The final alignment check is to make sure the stabilizers are perpendicular to the fin. Use a square to check this on both the right and left stabilizer halves.

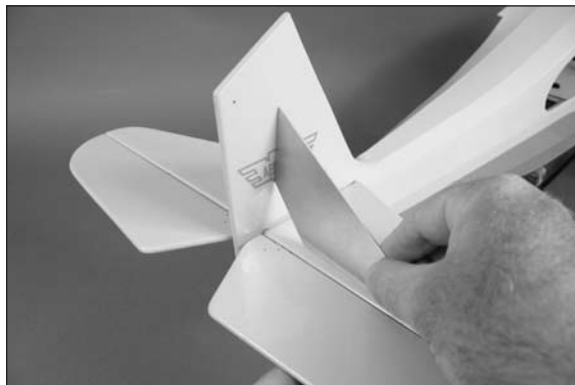

Note: Because the covering is flared near the base of the fin, you will need to use a square that is notched as shown in the photo, or measure the angle as close to the hinge line as possible to avoid the covering interfering with checking the alignment.

E-tips

Use a paper towel and rubbing alcohol to remove any excess epoxy from the fuselage and stabilizer before it fully cures.

- 9. Once the alignment has been checked, mix a small amount of 12-minute epoxy and apply it to the dowels on the stabilizers and into the tubes in the fuselage using a toothpick. Position the stabilizers and check the alignment as the epoxy cures.

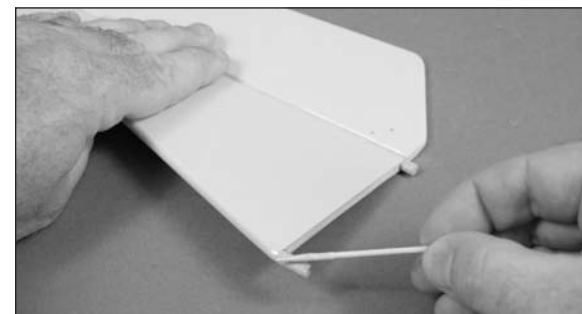
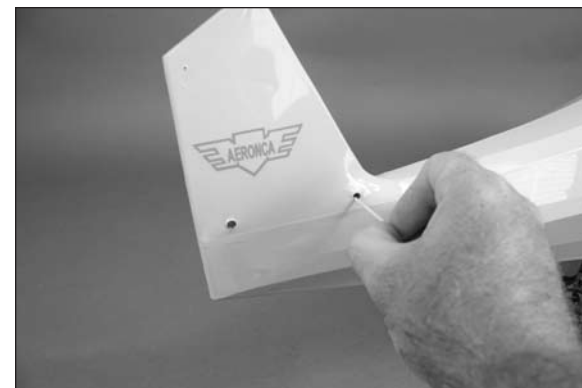

E-tips

We used low-tack tape between the stabilizers and fin to keep the stabilizers in alignment until the epoxy cured. We also taped the ruler to the elevators to keep them from moving. Make sure not to allow the stabilizers to move away from the fuselage when applying the tape.

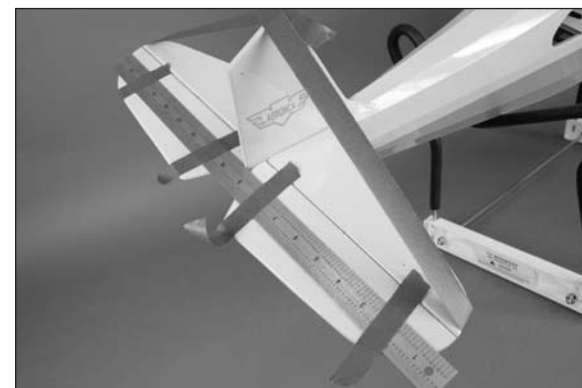

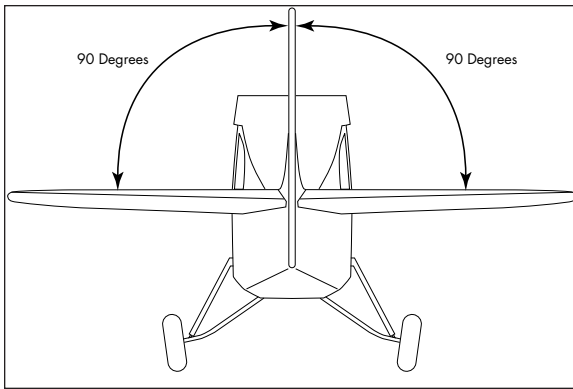

- 10. Locate the CA hinges. Place a T-pin in the center of two of the hinges. This will center these hinges equally in the rudder and fin when they are installed.

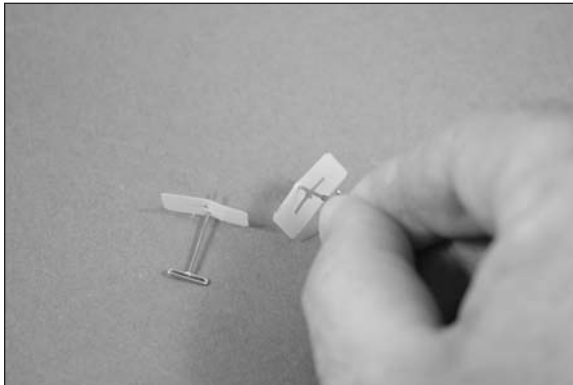

- 11. Place the hinges in the slots in the fin. The hinge that does not have a T-pin is located at the top of the fin as it will only slide in partially due to the hardwood block installed in the fin for the tail rigging.



- 12. Position the rudder on the fuselage and fin. Remove the T-pins from the hinges. There should be no gap between the rudder and fin along the hinge line.



- 13. Check the gap between the rudder balance tab and top of the fin. There should be just enough clearance to allow the rudder to move without binding on the fin.



E-tips

When gluing the hinges, the CA must be allowed to soak into the hinges to provide the best bond between the hinge and surrounding wood. Do not use a CA accelerator when gluing the hinges.

- 14. Apply CA to each of the hinges. Make sure to saturate each hinge on both sides of the hinge.



- 15. Gently pull on the fin and rudder to check that the hinges are glued securely. If you find any loose hinges, apply thin CA to the hinge to secure its location.

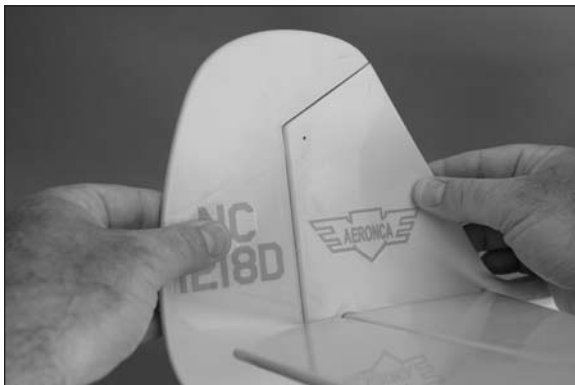

- 16. Flex the control surface through its range of motion a number of times to break in the hinges.



Rudder and Elevator Servo Installation

Required Parts

Fuselage assembly Transmitter
 Receiver Receiver battery
 Nylon clevis (3) Servo with hardware (2)
 Elevator pushrod, dual soldered, 19-inch (482mm)
 Rudder pushrod, 19⁷/₈-inch (505mm)
 Silicone clevis retainer (3)
 2mm x 8mm machine screw (6)
 Control horn with backplate (3)

Required Tools and Adhesives

Side cutter Pin vise
 Thin CA Pencil
 Straight edge Phillips screwdriver: #1
 Hobby knife with #11 blade
 Drill bit: 1/16-inch (1.5mm), 5/64-inch (2mm)

- 1. Use a hobby knife to remove the backplate from the three control horns. Remove any flashing from between the horn and backplate at this time.

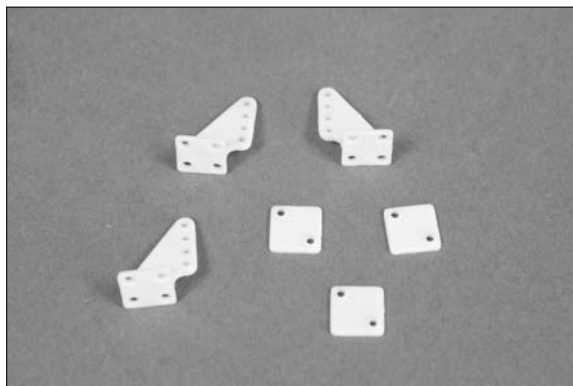

- 2. Use two 2mm x 8mm machine screws and a #1 Phillips screwdriver to attach the control horn to the bottom of the elevator. Note that only two of the holes in the horn will be used, and these holes align with the holes pre-drilled in the elevator. Use the backplate on the top of the elevator to complete the control horn installation.



E-tips

If you find any of the screw holes for the control horns blocked by a CA hinge, use a pin vise and 5/64-inch (2mm) drill bit to drill through the hinge so the screw can be installed.

- 3. Repeat Step 2 to install control horns on the rudder and remaining elevator. Note that the rudder control horn is on the left side of the fuselage as if you were sitting in the pilot seat.



- 4. Slide the $1\frac{7}{8}$ -inch (505mm) rudder pushrod into the guide tube in the fuselage. You may need to assist it exiting the rear of the fuselage so it doesn't damage the covering at the exit.

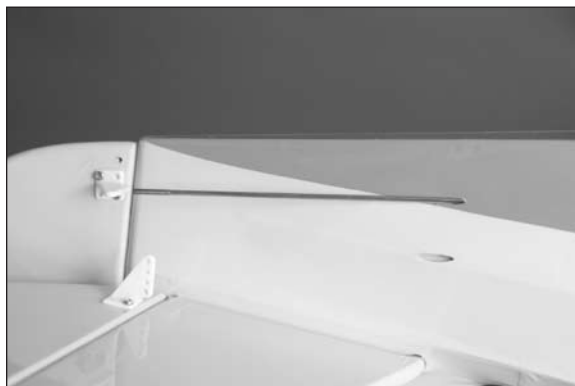

- 5. Slide a silicone clevis retainer over a nylon clevis. Thread the clevis 10-turns on the end of the rudder pushrod. Connect the clevis to the outer hole of the rudder control horn. The overall length of the pushrod must still be adjusted, so don't slide the retainer over the clevis at this time.

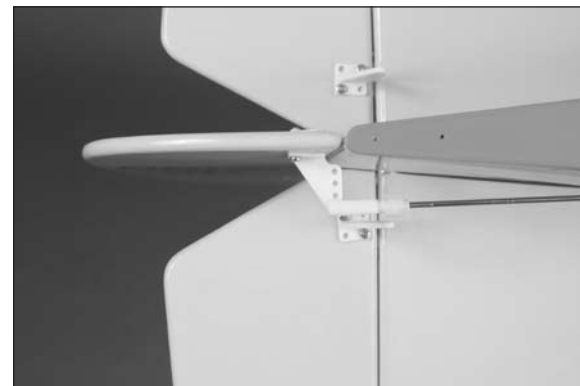

- 6. Install the servo grommets and brass eyelets following the instructions provided with the servo. Prepare both the rudder and elevator servos at this time. Remove the horn from the servo at this time using a #1 Phillips screwdriver.



- 7. Locate the standard servo horn included with your servo. Use a pin vise and 5/64-inch (2mm) drill bit to enlarge the hole in the servo arm that is 3/8-inch (9.5mm) from the center of the horn. Use side cutters to remove any unused arm from the horn so they don't interfere with the operation of the servo.

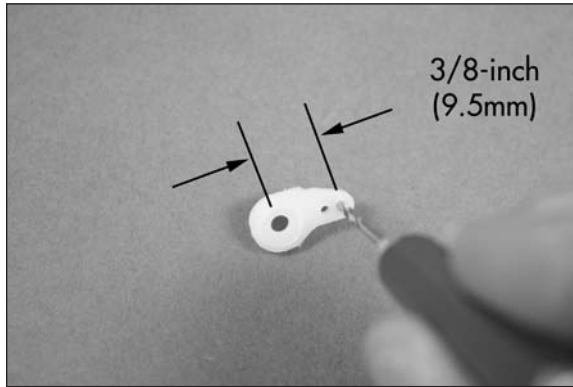

- 8. Use a #1 Phillips screwdriver to remove the stock servo horn from the servo. Install the servo horn prepared in Step 6 on the servo. Note the position of the servo horn for the rudder and elevator servos.

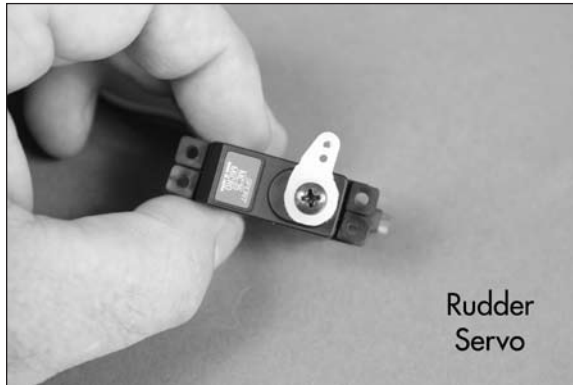

- 9. Insert the rudder servo in the fuselage by placing the servo in the servo tray at an angle, then rotating it into position. Note that the output shaft on the servo faces to the front of the fuselage.



- 10. Slide the rudder servo into position. The rudder pushrod will align with the hole in the servo horn enlarged in Step 6. Use a pencil to mark the location for the servo mounting screws on the servo tray.



- 11. Remove the servo from the servo tray. Use a pin vise and 1/16-inch (1.5mm) drill bit to drill the four holes for the servo mounting screws.

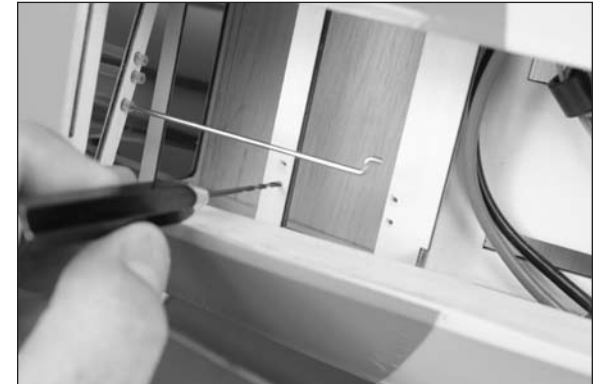

- ○ 12. Apply 2–3 drop of thin CA in each of the holes to harden the surrounding wood. This will help in preventing the screws from vibrating loose.

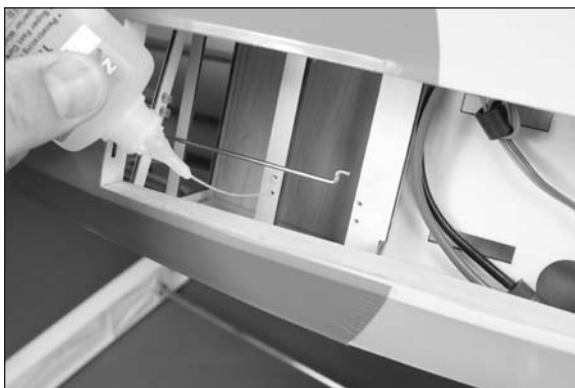

- ○ 13. Remove the servo horn from the servo. Use the screws provided with the servo and a #1 Phillips screwdriver to secure the servo in position.

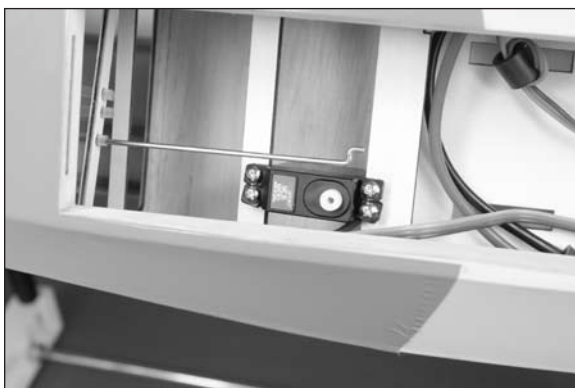

- ○ 14. Disconnect the clevis at the rudder control horn. Insert the bend in the rudder pushrod in the hole enlarged in Step 6 for the servo horn. With the rudder servo centered, attach the servo horn on the servo so it is perpendicular to the servo centerline. Install the screw securing the horn to the servo using a #1 Phillips screwdriver.



- 15. Repeat Steps 4 through 14 to install the 19-inch (482mm) elevator pushrod.

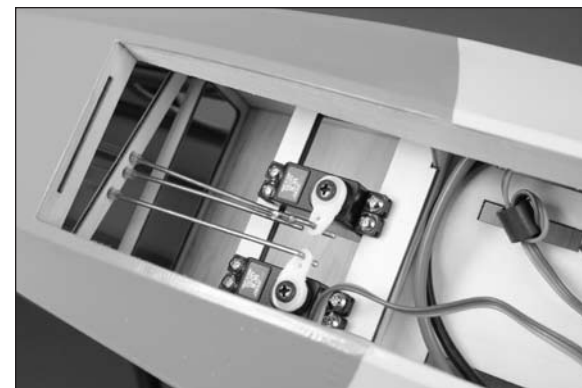
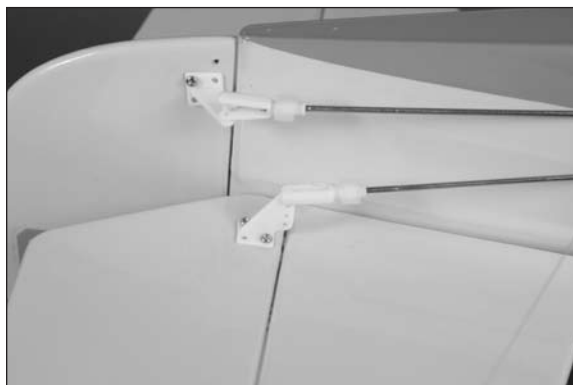

- 16. With the servos plugged into the receiver and the radio system on, center the sticks and trims for the rudder and elevator. Use a straight edge to make sure the elevator is aligned with the stabilizer. Adjust the clevis on the elevator pushrod as necessary so the elevator and stabilizer are in alignment when the clevis is connected to the outer hole of the elevator control horn. Check both the left and right elevators. Once aligned, slide the silicone clevis retainer over the forks of the clevis to prevent it from opening accidentally in flight.

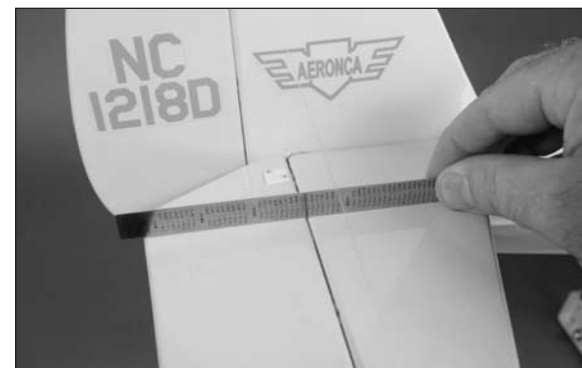

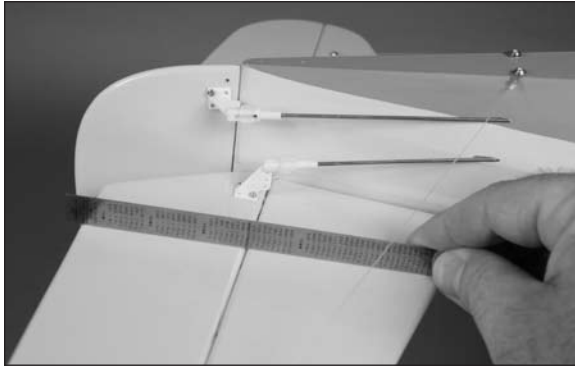
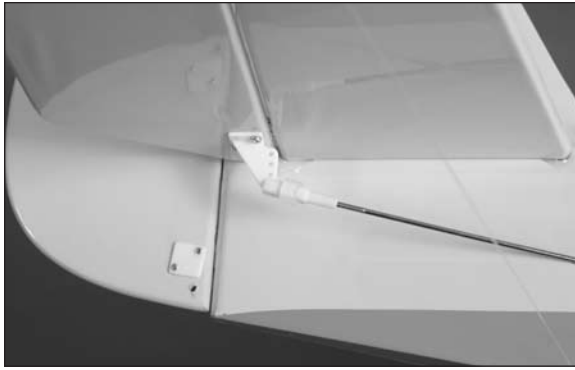

- 17. Adjust the position of the clevis on the rudder pushrod so the balance tab on the rudder is aligned with the fin when the clevis is connected to the control horn. Once adjusted, slide the silicone clevis retainer over the forks of the clevis to keep it from opening accidentally in flight.

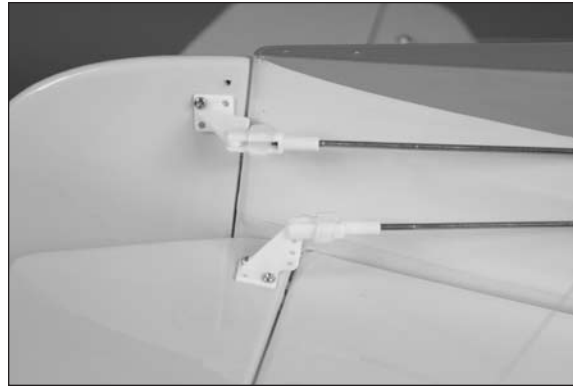
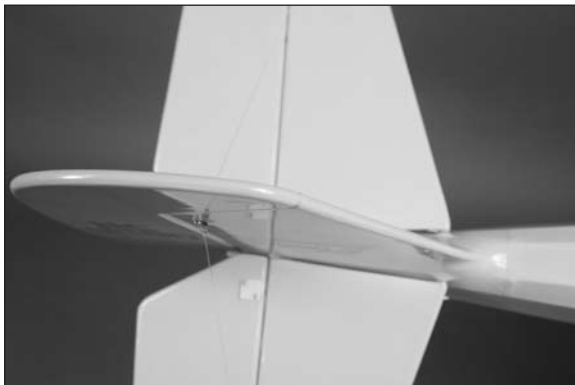

Tail Wheel Installation

Required Parts

Fuselage assembly Tail wheel assembly
2mm nut 2mm x 8mm machine screw
2mm x 8mm sheet metal screw (2)
Rudder steering bracket (2)
Tail wheel spring (2)

Required Tools and Adhesives

Side cutter Threadlock
Nut driver: 4mm Needle nose pliers
Ruler Phillips screwdriver: #1

E-tips

Make sure to use threadlock on all metal-to-metal fasteners so they don't vibrate loose.

- 1. Attach the two rudder steering brackets to the rudder using a 2mm x 8mm machine screw and 2mm nut. The bracket will angle down from the mounting hole in the rudder. Tighten the hardware using a #1 Phillips screwdriver and 4mm nut driver.





- 2. Attach the tail wheel assembly to the bottom of the fuselage using two 2mm x 8mm sheet metal screws and a #1 Phillips screwdriver.



- 3. Use needle nose pliers to bend a small loop in one end of the spring.

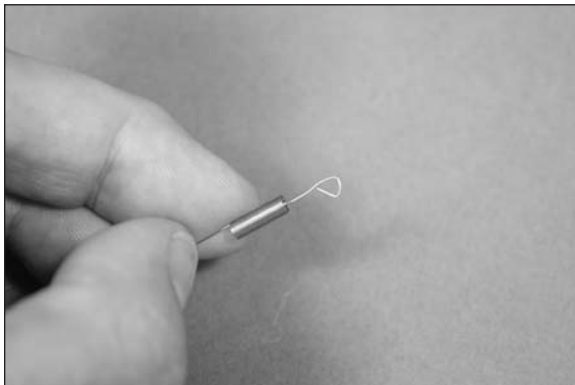

- 4. Make a second loop in the spring using pliers. The overall length of the spring will be 1-inch (25mm) as shown. Use side cutters to trim any excess wire.

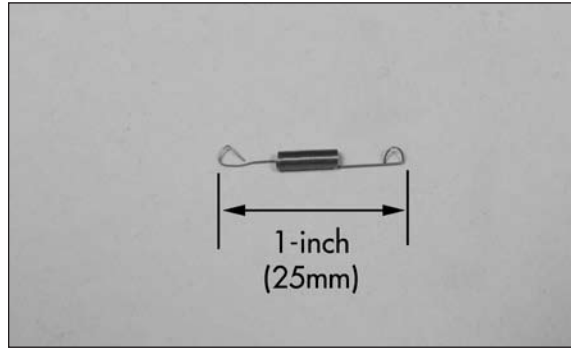

- 5. Attach the spring between the rudder steering bracket and the tail wheel tiller arm.



- 6. Repeat Steps 3 through 6 to prepare and install the remaining tail wheel spring.



Receiver Installation

Required Parts

Fuselage assembly Hook and loop tape
 Receiver
 Servo extension, 9-inch (228mm)
 Servo extension, 12-inch (305mm)
 Y-harness (optional if not using a computer radio)

Required Tools and Adhesives

Scissors Medium CA
 Hemostat

- 1. Insert the 9-inch (228mm) and 12-inch (305mm) extensions through the hole in the cockpit floor. Make sure the end that plugs into the receiver is inserted into the hole.



- 2. Use hemostats to retrieve the leads for the aileron servos and bring them up along side the rudder servo. Plug the 12-inch (305mm) extension into the aileron channel, the 9-inch (228mm) extension into the flap channel, and rudder, elevator and speed control into the correct ports of the receiver.



Note: Use a Y-harness for both aileron leads when using a non-computer radio without the capability of individual aileron channels. Plug the Y-harness into the aileron port of the radio.

- 3. Use scissors to cut a piece of hook and loop tape to fit the receiver. Peel the backing from the tape and place it on the back of the receiver.

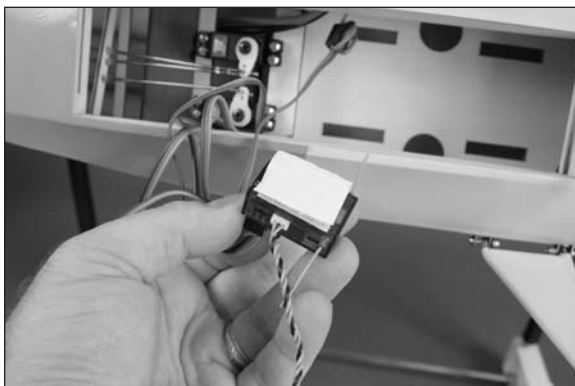

- 4. Use the hook and loop tape to secure the receiver in the fuselage. Make sure the antennas on the receiver, are straight. If they are not straight, it could reduce the range of the radio system. Carefully tuck the servo leads so they don't interfere with the operation of the rudder and elevator servos.



- 5. Use scissors to cut a small piece of hook and loop tape sized to fit the remote receiver. Use the hook and loop tape to mount the remote receiver forward and inside the fuselage as indicated. Note the direction of the antenna for the remote receiver.

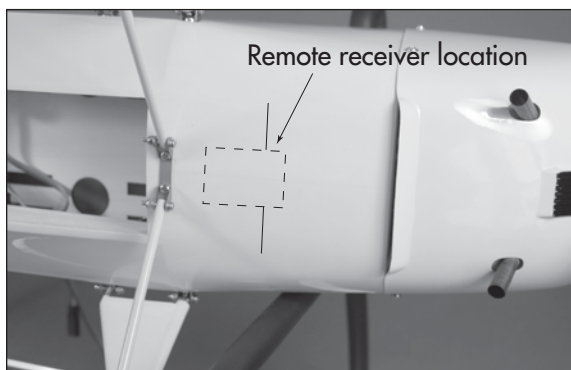

- 6. Use medium CA to tack glue to the servo leads for the aileron extensions. This will keep them hidden, enhancing the appearance of your model.

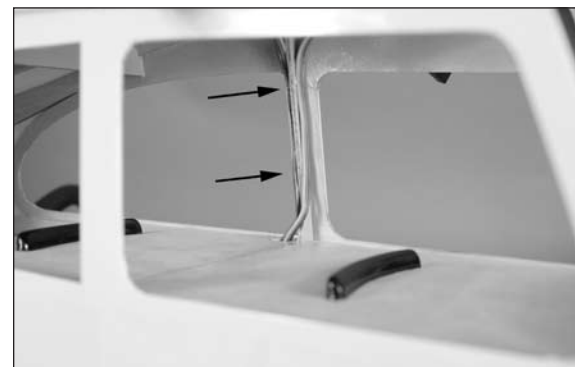

Window Installation

Required Parts

Fuselage assembly Front windscreen
Rear window (right and left)
Center window (right and left)

Required Tools and Adhesives

Canopy glue Low-tack tape
Scissors

Optional Items

Pilot figure Medium CA

- 1. Test fit the rear windows into position from the inside of the fuselage. It may be necessary to use scissors to trim the windows along the bottom if it interferes with the cockpit floor. Once fit, apply canopy glue around the perimeter of the window where it contacts the fuselage. Use low-tack tape to hold the window in position until the glue fully cures.



- 2. Repeat Step 1 to secure the side windows in the fuselage.

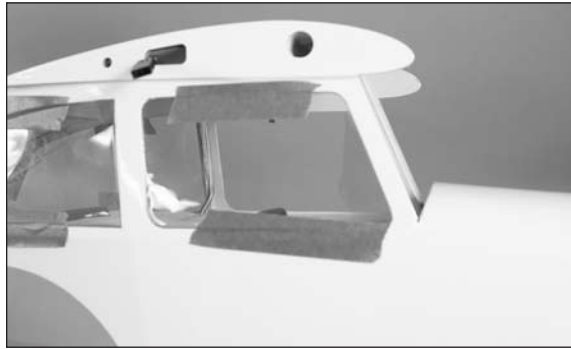

- 3. (Optional) If you are installing the optional pilot, use medium CA to assemble the pilot.



- 4. (Optional) Use scissors to shorten the height of the pilot 3/8-inch (9mm).

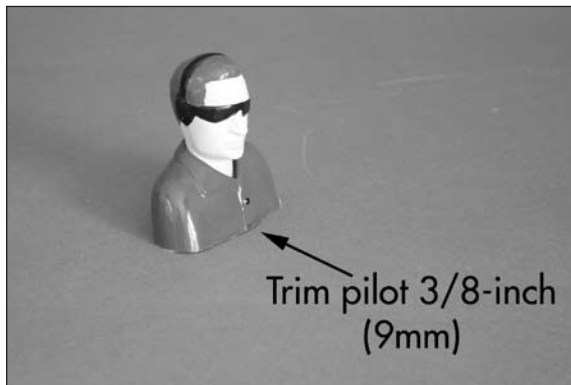

- 5. (Optional) Use canopy glue to glue the pilot to the cockpit floor. Form a small fillet between the pilot and cockpit floor to secure the pilot. Allow the glue to cure before proceeding.



- 6. Test fit the front windscreen into position. Once fit, apply canopy glue around the perimeter of the windscreen where it contacts the fuselage. Use low-tack tape to hold the windscreen in position until the glue fully cures.



Etips

Although it is suggested to allow the glue on the windows to cure and remove the tape before proceeding, you can install the wing panels and struts if you are careful not to disturb the windows.

Wing Installation

Required Parts

Fuselage assembly Wing strut (2)
2mm locknut (4) Wing strut support fitting (4)
Wing panel assembly (right and left)
Aluminum wing tube
2mm x 5mm machine screw (4)
2mm x 8mm sheet metal screw (4)
2.6mm x 10mm sheet metal screw (2)
Wing strut support, long (right and left)
Wing strut support, short (2)
Wing strut support cross brace (2)
Wing strut nylon fitting (4)

Required Tools and Adhesives

Drill Drill bit: 1/16-inch (1.5mm)
Nut driver: 4mm Phillips screwdriver: #1
Low-tack tape Needle nose pliers

- 1. Slide the aluminum wing tube into the socket in the fuselage. Position the tube so it is centered in the fuselage. Wrap a small piece of low-tack tape around the tube against the fuselage on one side so it can be quickly positioned if it moves.

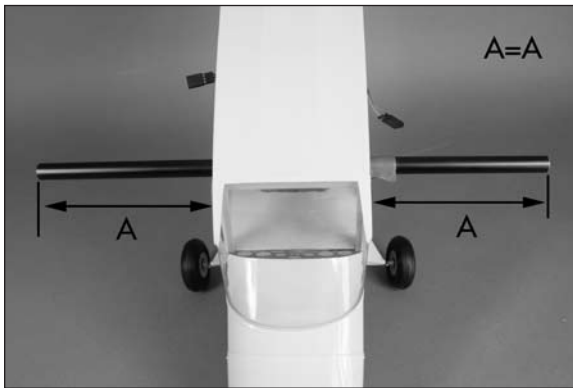

- 2. Slide a wing panel on the wing tube on the side without the tape. Make sure to connect the extensions from the wing and fuselage.



- 3. Slide the wing tightly against the fuselage. Check to make sure the wing tube has not slid out of position. If so, reposition the wing tube so the tape is against the fuselage.



- 4. Use a drill and 1/16-inch (1.5mm) drill bit to drill a hole through one wall of the wing tube. There is a small hole in the wing in the correct location to use as a guide. Use care not to drill completely through the tube and through the top of the wing.

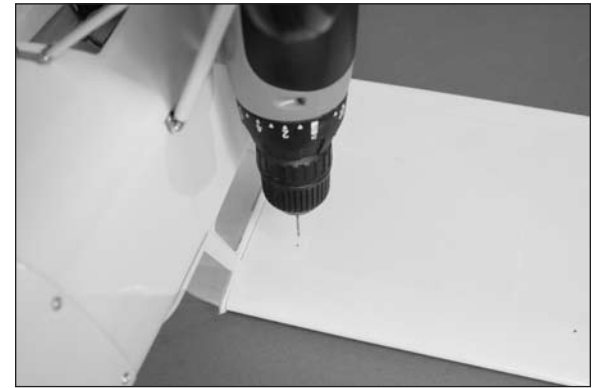

- 5. Use a #1 Phillips screwdriver to install the 2.6mm x 10mm sheet metal screw that holds the tube in the wing panel. Use care not to strip the head of the screw during its installation as you are tapping the aluminum tube to fit the screw. Remove the tape from the tube on the other side.



- 6. Locate the long wing strut supports. Note that there is a right and left support, which are differentiated by the angled cut near the L-bend in the wire. Make sure to install these in the correct wing panel. Note that left and right are viewed as if sitting in the pilot seat.

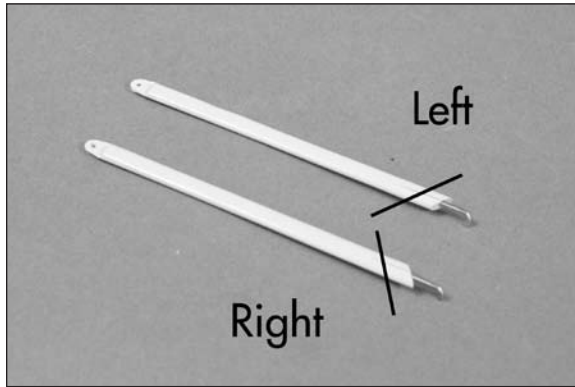

- 7. Insert the bend in the wing strut supports in the wing with the support facing the fuselage. Carefully lift the strut support into position so it is perpendicular to the wing. Note that the longer support is located near the trailing edge of the wing. Insert both the long and short supports at this time.

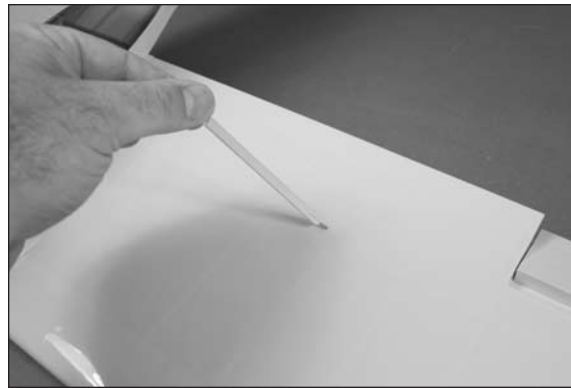

- 8. Locate the wing struts. The wider strut will face to the front of the airframe, while the narrow strut will face the rear of the airframe.

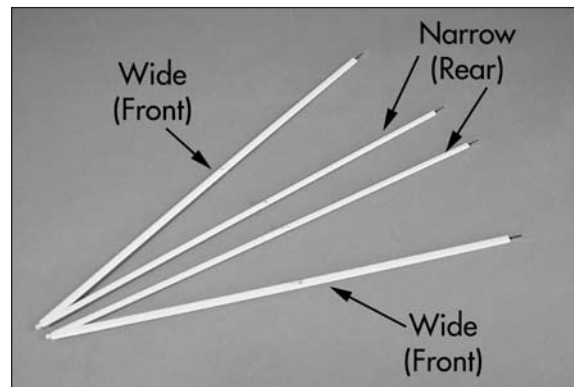

- 9. Install the two wing strut support fittings in the struts using two 2mm locknuts. Use pliers to hold the fitting and a 4mm nut driver to hold the nut. Leave the fittings slightly loose so they can be positioned when installing the wing strut supports. Note that the flat side of the fitting faces to the end of the strut that will attach to the wing.

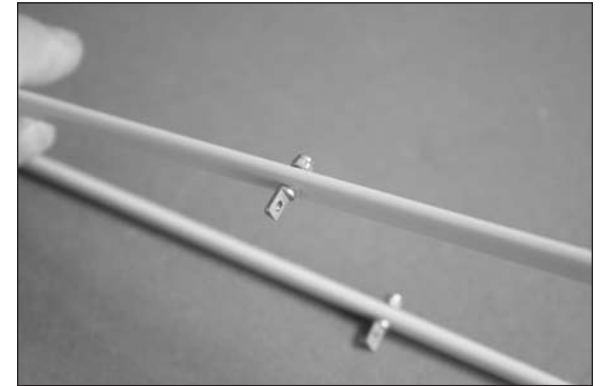

- 10. Locate the nylon strut fittings. Carefully bend the fitting slightly once along the embossed line. Repeated bending can damage the fitting and may cause it to fail in flight. Prepare two fittings at this time.



- 11. Thread the nylon strut fittings on the threaded rods of the wing struts.

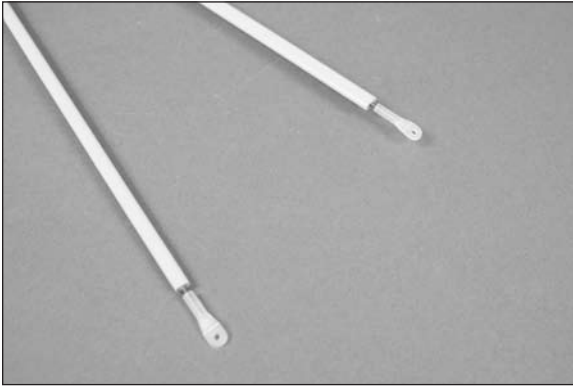

- 12. Remove the hardware from the rear landing gear strut mount. Use care not to lose the washer or nut when removing the hardware. Position the wing strut, then reinstall the hardware using a 4mm nut driver and #1 Phillips screwdriver. Make sure not to over-tighten the hardware so the strut can move for positioning.



- 13. Position the nylon strut fittings and check that they fall naturally over the holes in the wing. If not, readjust the fittings so they do. Use two 2mm x 8mm sheet metal screws and a #1 Phillips screwdriver to secure the strut fittings to the wing.

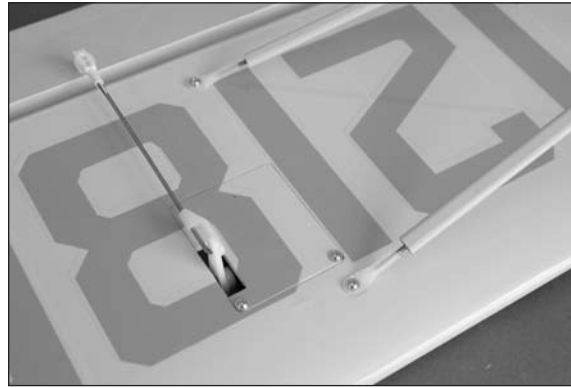

- 14. Insert a 2mm x 5mm machine screw in the support cross brace. The screw then goes through the support and threads in the fitting. Tighten the screw using a #1 Phillips screwdriver. Use two screws to secure the front and rear supports to the fittings.



- 15. Repeat Steps 2 through 14 to install the remaining wing strut.

E-tips

When removing the wing panels from the fuselage, remove the screw from only one wing panel. It may be difficult to align the hole for the screw if the wing tube is completely removed from both wing panels.

Tail Rigging Installation

Required Parts

Airframe Rigging line
Rigging fittings (8) 2mm nut (3)
2mm x 6mm sheet metal screw (2)
2mm x 8mm machine screw (3)

Required Tools and Adhesives

Hemostat or tweezers
Needle nose pliers Square
Thin CA Phillips screwdriver: #1
Nut driver: 4mm Ruler
Scissors



CAUTION: The tail bracing is functional and must be used for proper support.

- 1. Locate the eight rigging fittings. Using needle nose pliers, make a slight bend (about 30 degrees) in each of the fittings as shown. Make the bend as close to the smaller hole as shown in the photo.



E-tips

Make sure to use threadlock on all metal-to-metal fasteners so they don't vibrate loose.

- 2. Attach a fitting to the top and bottom of the stabilizer using a 2mm x 8mm machine screw and a 2mm nut. Make sure the small hole in the fitting faces in the direction of the hole in the fin on the top, and to the pre-drilled hole for the fitting on the bottom of the fuselage. Use a #1 Phillips screwdriver and 4mm nut driver to tighten the hardware. Install fittings on both the left and right stabilizers at this time. Do not fully tighten the nuts at this time.

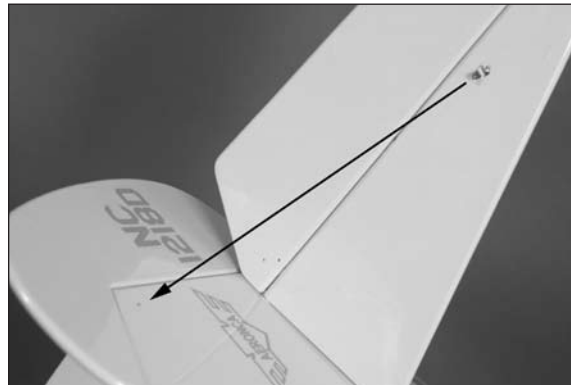

- 3. Attach a pair of rigging fittings to the rudder using a 2mm x 8mm machine screw and a 2mm nut. Make sure the small hole in the fitting faces in the direction of the fittings on the top of the stabilizer. Use a #1 Phillips screwdriver and 4mm nut driver to tighten the hardware. Do not fully tighten the nuts at this time.



- 4. Install the last two fittings on the bottom of the fuselage using 2mm x 6mm sheet metal screws. Make sure the fittings are directed toward the fittings on the bottom of the stabilizer. Use a #1 Phillips screwdriver to tighten the screws. Do not fully tighten the screws fully at this time.

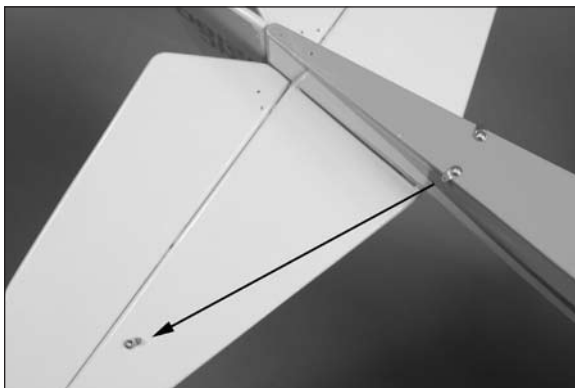

- 5. Tie the rigging line to the fitting on the fin. We recommend using tweezers or hemostats to hold onto the line while tying the knot. Once tied, place a drop of thin CA on the knot to keep it from coming loose.



- 6. Tie the rigging at the fitting on the top of the stabilizer. Use hemostats or tweezers to hold the line while tying the knot. Place a light amount of tension on the line. Make sure not to pull the stabilizer out of alignment with the fin, so use a square to verify the stabilizer and fin are still aligned. Once tied, place a drop of thin CA on the knot. Use scissors to trim the excess line as close to the fitting as possible.



- 7. Repeat Steps 5 and 6 for the opposite side.



- 8. Tie the rigging on the bottom from the stabilizer to the fuselage. Again, use hemostats or tweezers when tying the knots, and apply a drop of thin CA on the knot to prevent it from coming loose. Fully tighten all of the nuts and screws on the rigging at this time using a #1 Phillips screwdriver and 4mm nut driver. Use thin CA on the outer side of each nut to hold them in place.



Battery Installation and Center of Gravity

Required Parts

Airframe assembly Hook and loop tape
Motor battery (charged)
Battery/radio cover

Required Tools and Adhesives

Balancing stand Thin CA
Felt-tipped pen

- 1. Apply the hook and loop tape inside the battery compartment as shown. Wick thin CA along the edges of the tape to secure it to the battery tray.



- 2. Apply the mating surface of the hook and loop tape to the battery. Install the battery into the compartment.



- 3. Replace the battery hatch on the fuselage.

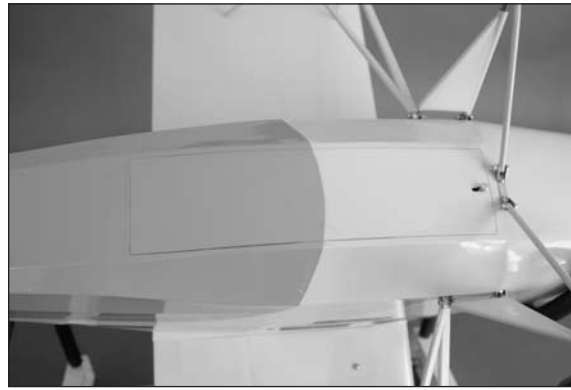

An important part of preparing the aircraft for flight is properly balancing the model.



CAUTION: Do not inadvertently skip this step or property damage and injury could occur.

- 4. The recommended Center of Gravity (CG) location for your model is $1\frac{7}{8}$ to $2\frac{3}{8}$ inches (48 to 60mm) back from the leading edge of the top wing as shown with the battery pack installed. Mark the location of the CG on the bottom of the wing with a felt-tipped pen.

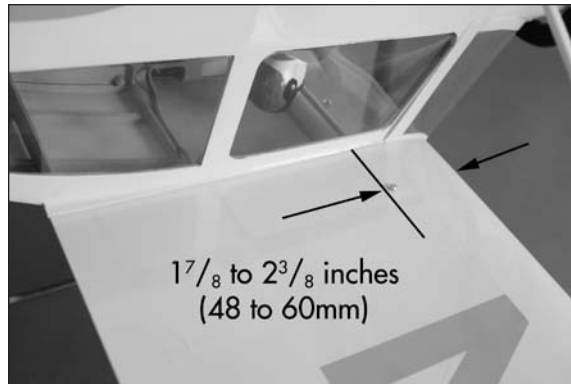

- 5. When balancing your model, support the plane upright at the marks made on the bottom of the wing with your fingers or a commercially available balancing stand. This is the correct balance point for your model. Make sure your model is assembled and ready for flight before balancing.

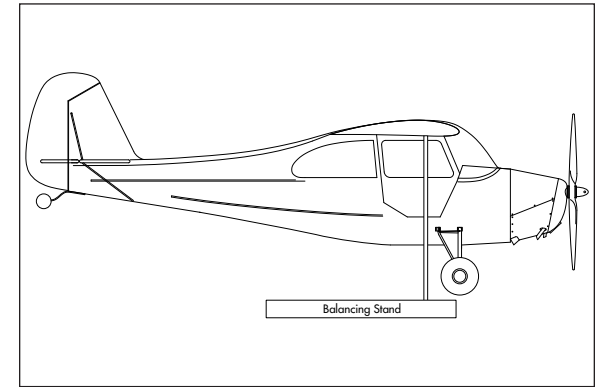

Adjust the motor battery as necessary so the model is level or slightly nose down. This is the correct balance point for your model. You should find the CG to be very close with the battery installed as shown in this manual. Mark the location of the battery on the battery tray using a felt-tipped pen so it can be returned to this position if it is removed from your model.

After the first flights, the CG position can be adjusted for your personal preference.

Control Throws

- 1. Turn on the transmitter and receiver of your model. Check the movement of the rudder using the transmitter. When the stick is moved right, the rudder should also move right. Reverse the direction of the servo at the transmitter if necessary.
- 2. Check the movement of the elevator with the radio system. Moving the elevator stick toward the bottom of the transmitter makes the airplane elevator move up.
- 3. Check the movement of the ailerons with the radio system. Moving the aileron stick right makes the right aileron move up and the left aileron move down.
- 4. Use a ruler to adjust the throw of the elevator, ailerons and rudder. Adjust the position of the pushrod at the control horn to achieve the following measurements when moving the sticks to their endpoints.

Elevator High Rate (100%)

Up	11/16-inch	(18mm)	0% Exponential
Down	11/16-inch	(18mm)	0% Exponential

Elevator Low Rate

Up	9/16-inch	(14mm)	0% Exponential
Down	9/16-inch	(14mm)	0% Exponential

Aileron High Rate (100%)

Up	1 ¹ / ₈ -inch	(28mm)	10% Exponential
Down	11/16-inch	(18mm)	10% Exponential

Aileron Low Rate

Up	7/8-inch	(22mm)	0% Exponential
Down	9/16-inch	(14mm)	0% Exponential

Note: If using a Y-harness for the ailerons instead of separate channels, you will not be able to achieve the differential travel listed for the aileron control throws. The travel will be more equal up and down. This will not hurt the flight performance of the Champ but will require you to use some coordinated rudder through the turns. Using separate channels for the ailerons and the differential travel will optimize the flight characteristics of the Aeronca Champ.

Rudder High Rate (100%)

Right	1 ³ / ₁₆ -inch	(30mm)	0% Exponential
Left	1 ³ / ₁₆ -inch	(30mm)	0% Exponential

Rudder Low Rate

Right	13/16-inch	(20mm)	0% Exponential
Left	13/16-inch	(20mm)	0% Exponential

E-tips

Measurements are taken at the inner or widest point on the control surface.

These are general guidelines measured from our own flight tests. You can experiment with higher rates to match your preferred style of flying.

E-tips

Travel Adjust and Sub-Trims are not listed and should be adjusted according to each individual model and preference.

E-tips

We highly recommend re-binding the radio system once all the control throws are set. This will keep the servos from moving to their endpoints until the transmitter and receiver connect.

Preflight

Check Your Radio

Before going to the field, be sure your batteries are fully charged per the instructions included with your radio. Charge the transmitter and motor battery for your airplane. Use the recommended charger supplied with your particular radio system, following the instructions provided with the radio. In most cases, the radio should be charged the night before going out flying.

Before each flying session, be sure to range check your radio. See your radio manual for the recommended range and instructions for your radio system. Each radio manufacturer specifies different procedures for their radio systems. Next, run the motor. With the model securely anchored, check the range again. The range test should not be significantly affected. If it is, don't attempt to fly! Have your radio equipment checked out by the manufacturer.

Double-check that all controls (aileron, elevator, rudder and throttle) move in the correct direction.

Check the radio installation and make sure all the control surfaces are moving correctly (i.e., the correct direction and with the recommended throws).

Check all the control horns, servo horns, and clevises to make sure they are secure and in good condition.

Flying Your Aeronca Champ 15e ARF

Flying the Aeronca Champ 15e is a bunch of fun and will be enjoyable for all skill levels. A very light wing loading and mild control throws make for some enjoyable evening flying. Verify that your CG is at the correct location as per the manual and that you have your rates set up to your liking. Verify all control throws are in the correct direction and the motor spins in the correct direction also.

Point the model into the wind and add some throttle trim until the motor begins to turn. This will be your flight idle. Now, apply power slowly, the model may swing slightly to the left so some right rudder may be needed on takeoff. You will find the model will become airborne very quickly and at a low speed. This model excels at flying slow and easy. Trim the model for level flight at half throttle.

The Aeronca Champ 15e has plenty of power with the E-flite Power 15 so you will only need to use full throttle for maneuvering. To land the Aeronca Champ 15e, just reduce the throttle to idle and feed in up elevator until the model settles into a slightly nose-high attitude. Gently fly the model down to the landing spot with a final flair at touchdown. You will find the model will have a very short roll out. Both wheel landings and 3 point landings are capable with this aircraft and the shock absorbing landing gear will smooth out any of the bumps along the way. We hope you enjoy the Aeronca Champ 15e as much as we do.

Happy Landings!

Range Test Your Radio

Before each flying session, and especially with a new model, it is important to perform a range check. It is helpful to have another person available to assist during the range check. If you are using a Spektrum transmitter, please refer to your transmitter's manual for detailed instructions on the range check process.

- 1. With the model resting on the ground, stand 30 paces (approximately 90 feet) away from the model.
- 2. Face the model with the transmitter in your normal flying position. Be sure the throttle is in the full down position and plug the flight battery into the speed control.
- 3. As you move the controls, watch to be sure the airplane's motor and controls operate smoothly. You should have total control of the model at 30 paces (90 feet).
- 4. If control issues exist, call the appropriate Horizon Product Support office (see page 22) or go to horizonhobby.com to find a local Spektrum distributor in your country for service if using a Spektrum radio system.

Safety Do's and Don'ts for Pilots

- Check all control surfaces prior to each takeoff.
- Do not fly your model near spectators, parking areas or any other area that could result in injury to people or damage of property.
- Do not fly during adverse weather conditions. Poor visibility can cause disorientation and loss of control of your aircraft. Strong winds can cause similar problems.
- Do not take chances. If at any time during flight you observe any erratic or abnormal operation, land immediately and do not resume flight until the cause of the problem has been ascertained and corrected. Safety can never be taken lightly.
- Do not fly near power lines.

Daily Flight Checks

- 1. Check the battery voltage of the transmitter battery. Do not fly below the manufacturer's recommended voltage. To do so can crash your aircraft.

E-tips

When you check these batteries, ensure you have the polarities correct on your expanded scale voltmeter.

- 2. Check all hardware (linkages, screws, nuts, and bolts) prior to each day's flight. Be sure that binding does not occur and that all parts are properly secured.
- 3. Ensure all surfaces are moving in the proper manner.
- 4. Perform a ground range check before each day's flying session.
- 5. Prior to starting your aircraft, turn off your transmitter, then turn it back on. Do this each time you start your aircraft. If any critical switches are on without your knowledge, the transmitter alarm will sound a warning at this time.
- 6. Check that all trim levers are in the proper location.
- 7. All servo pigtailed and switch harness plugs should be secured in the receiver. Make sure the switch harness moves freely in both directions.

Warranty and Repair Policy

WARRANTY PERIOD

Exclusive Warranty- Horizon Hobby, Inc., (Horizon) warranties that the Products purchased (the "Product") will be free from defects in materials and workmanship at the date of purchase by the Purchaser.

LIMITED WARRANTY

Horizon reserves the right to change or modify this warranty without notice and disclaims all other warranties, express or implied.

(a) This warranty is limited to the original Purchaser ("Purchaser") and is not transferable. REPAIR OR REPLACEMENT AS PROVIDED UNDER THIS WARRANTY IS THE EXCLUSIVE REMEDY OF THE PURCHASER. This warranty covers only those Products purchased from an authorized Horizon dealer. Third party transactions are not covered by this warranty. Proof of purchase is required for all warranty claims.

(b) Limitations- HORIZON MAKES NO WARRANTY OR REPRESENTATION, EXPRESS OR IMPLIED, ABOUT NON-INFRINGEMENT, MERCHANTABILITY OR FITNESS FOR A PARTICULAR PURPOSE OF THE PRODUCT. THE PURCHASER ACKNOWLEDGES THAT THEY ALONE HAVE DETERMINED THAT THE PRODUCT WILL SUITABLY MEET THE REQUIREMENTS OF THE PURCHASER'S INTENDED USE.

(c) Purchaser Remedy- Horizon's sole obligation hereunder shall be that Horizon will, at its option, (i) repair or (ii) replace, any Product determined by Horizon to be defective. In the event of a defect, these are the Purchaser's exclusive remedies. Horizon reserves the right to inspect any and all equipment involved in a warranty claim. Repair or replacement decisions are at the sole discretion of Horizon. This warranty does not cover cosmetic damage or damage due to acts of God, accident, misuse, abuse, negligence, commercial use, or modification of or to any part of the Product. This warranty does not cover damage due to improper installation, operation, maintenance, or attempted repair by anyone other than Horizon. Return of any Product by Purchaser must be approved in writing by Horizon before shipment.

DAMAGE LIMITS

HORIZON SHALL NOT BE LIABLE FOR SPECIAL, INDIRECT OR CONSEQUENTIAL DAMAGES, LOSS OF PROFITS OR PRODUCTION OR COMMERCIAL LOSS IN ANY WAY CONNECTED WITH THE PRODUCT, WHETHER SUCH CLAIM IS BASED IN CONTRACT, WARRANTY, NEGLIGENCE, OR STRICT LIABILITY. Further, in no event shall the liability of Horizon exceed the individual price of the Product on which liability is asserted. As Horizon has no control over use, setup, final assembly, modification or misuse, no liability shall be assumed nor accepted for any resulting damage or injury. By the act of use, setup or assembly, the user accepts all resulting liability.

If you as the Purchaser or user are not prepared to accept the liability associated with the use of this Product, you are advised to return this Product immediately in new and unused condition to the place of purchase.

Law: These Terms are governed by Illinois law (without regard to conflict of law principals).

Warranty Services

QUESTIONS, ASSISTANCE, AND REPAIRS

Your local hobby store and/or place of purchase cannot provide warranty support or repair. Once assembly, setup or use of the Product has been started, you must contact Horizon directly. This will enable Horizon to better answer your questions and service you in the event that you may need any assistance. For questions or assistance, please direct your email to productsupport@horizonhobby.com, or call 877.504.0233 toll free to speak to a Product Support representative. You may also find information on our website at www.horizonhobby.com.

INSPECTION OR REPAIRS

If this Product needs to be inspected or repaired, please use the Horizon Online Repair Request submission process found on our website or call Horizon to obtain a Return Merchandise Authorization (RMA) number. Pack the Product securely using a shipping carton. Please note that original boxes may be included, but are not designed to withstand the rigors of shipping without additional protection. Ship via a carrier that provides tracking and insurance for lost or damaged parcels, as Horizon is not responsible for merchandise until it arrives and is accepted at our facility. An Online Repair Request is available at www.horizonhobby.com <http://www.horizonhobby.com> under the Repairs tab. If you do not have internet access, please contact Horizon Product Support to obtain a RMA number along with instructions for submitting your product for repair. When calling Horizon, you will be asked to provide your complete name, street address, email address and phone number where you can be reached during business hours. When sending product into Horizon, please include your RMA number, a list of the included items, and a brief summary of the problem. A copy of your original sales receipt must be included for warranty consideration. Be sure your name, address, and RMA number are clearly written on the outside of the shipping carton.

Notice: Do not ship batteries to Horizon. If you have any issue with a battery, please contact the appropriate Horizon Product Support office.

WARRANTY INSPECTION AND REPAIRS

To receive warranty service, you must include your original sales receipt verifying the proof-of-purchase date. Provided warranty conditions have been met, your Product will be repaired or replaced free of charge. Repair or replacement decisions are at the sole discretion of Horizon.

NON-WARRANTY REPAIRS

Should your repair not be covered by warranty the repair will be completed and payment will be required without notification or estimate of the expense unless the expense exceeds 50% of the retail purchase cost. By submitting the item for repair you are agreeing to payment of the repair without notification. Repair estimates are available upon request. You must include this request with your repair. Non-warranty repair estimates will be billed a minimum of ½ hour of labor. In addition you will be billed for return freight. Horizon accepts money orders and cashiers checks, as well as Visa, MasterCard, American Express, and Discover cards. By submitting any item to Horizon for inspection or repair, you are agreeing to Horizon's Terms and Conditions found on our website under the Repairs tab.

UNITED STATES

(Electronics and engines)

Horizon Service Center
4105 Fieldstone Rd
Champaign, Illinois
61822 USA
productsupport@horizonhobby.com
877-504-0233

(All other products)

Horizon Product Support
4105 Fieldstone Rd
Champaign, Illinois
61822 USA
productsupport@horizonhobby.com
877-504-0233

UNITED KINGDOM

Horizon Hobby Limited
Units 1-4 Ployters Rd
Staple Tye
Harlow, Essex
CM18 7NS
United Kingdom
sales@horizonhobby.co.uk
+44 (0) 1279 641 097

GERMANY

Horizon Technischer Service
Hamburger Str. 10
25335 Elmshorn
Germany
service@horizonhobby.de
+49 4121 46199 66

FRANCE

Horizon Hobby SAS
14 Rue Gustave Eiffel
Zone d'Activité du Réveil Matin
91230 Montgeron
+33 (0) 1 60 47 44 70

Compliance Information for the European Union



INSTRUCTIONS FOR DISPOSAL OF WEEE BY USERS IN THE EUROPEAN UNION

This product must not be disposed of with other waste. Instead, it is the user's responsibility to dispose of their waste equipment by handing it over to a designated collection point for the recycling of waste electrical and electronic equipment. The separate collection and recycling of your waste equipment at the time of disposal will help to conserve natural resources and ensure that it is recycled in a manner that protects human health and the environment. For more information about where you can drop off your waste equipment for recycling, please contact your local city office, your household waste disposal service or where you purchased the product.

Age Recommendation: 14 years or over. Not a toy. Not intended for use by children without direct adult supervision.

2010 Official Academy of Model Aeronautics Safety Code

GENERAL

1. A model aircraft shall be defined as a non-human-carrying device capable of sustained flight in the atmosphere. It shall not exceed limitations established in this code and is intended to be used exclusively for recreational or competition activity.
2. The maximum takeoff weight of a model aircraft, including fuel, is 55 pounds, except for those flown under the AMA Experimental Aircraft Rules.
3. I will abide by this Safety Code and all rules established for the flying site I use. I will not willfully fly my model aircraft in a reckless and/or dangerous manner.
4. I will not fly my model aircraft in sanctioned events, air shows, or model demonstrations until it has been proven airworthy.
5. I will not fly my model aircraft higher than approximately 400 feet above ground level, when within three (3) miles of an airport without notifying the airport operator. I will yield the right-of-way and avoid flying in the proximity of full-scale aircraft, utilizing a spotter when appropriate.
6. I will not fly my model aircraft unless it is identified with my name and address, or AMA number, inside or affixed to the outside of the model aircraft. This does not apply to model aircraft flown indoors.
7. I will not operate model aircraft with metal-blade propellers or with gaseous boosts (other than air), nor will I operate model aircraft with fuels containing tetranitromethane or hydrazine.

8. I will not operate model aircraft carrying pyrotechnic devices which explode, burn, or propel a projectile of any kind. Exceptions include Free Flight fuses or devices that burn producing smoke and are securely attached to the model aircraft during flight. Rocket motors up to a G-series size may be used, provided they remain firmly attached to the model aircraft during flight. Model rockets may be flown in accordance with the National Model Rocketry Safety Code; however, they may not be launched from model aircraft. Officially designated AMA Air Show Teams (AST) are authorized to use devices and practices as defined within the Air Show Advisory Committee Document.
9. I will not operate my model aircraft while under the influence of alcohol or within eight (8) hours of having consumed alcohol.
10. I will not operate my model aircraft while using any drug which could adversely affect my ability to safely control my model aircraft.
11. Children under six (6) years old are only allowed on a flightline or in a flight area as a pilot or while under flight instruction.
12. When and where required by rule, helmets must be properly worn and fastened. They must be OSHA, DOT, ANSI, SNELL or NOCSAE approved or comply with comparable standards.

RADIO CONTROL

1. All model flying shall be conducted in a manner to avoid over flight of unprotected people.
2. I will have completed a successful radio equipment ground-range check before the first flight of a new or repaired model aircraft.

3. I will not fly my model aircraft in the presence of spectators until I become a proficient flier, unless I am assisted by an experienced pilot.
4. At all flying sites a line must be established, in front of which all flying takes place. Only personnel associated with flying the model aircraft are allowed at or in front of the line. In the case of airshows demonstrations straight line must be established. An area away from the line must be maintained for spectators. Intentional flying behind the line is prohibited.
5. I will operate my model aircraft using only radio-control frequencies currently allowed by the Federal Communications Commission (FCC). Only individuals properly licensed by the FCC are authorized to operate equipment on Amateur Band frequencies.
6. I will not knowingly operate my model aircraft within three (3) miles of any preexisting flying site without a frequency-management agreement. A frequency management agreement may be an allocation of frequencies for each site, a day-use agreement between sites, or testing which determines that no interference exists. A frequency-management agreement may exist between two or more AMA chartered clubs, AMA clubs and individual AMA members, or individual AMA members. Frequency-management agreements, including an interference test report if the agreement indicates no interference exists, will be signed by all parties and copies provided to AMA Headquarters.
7. With the exception of events flown under official AMA rules, no powered model may be flown outdoors closer than 25 feet to any individual, except for the pilot and located at the flightline.

8. Under no circumstances may a pilot or other person touch a model aircraft in flight while it is still under power, except to divert it from striking an individual.
9. Radio-controlled night flying is limited to low-performance model aircraft (less than 100 mph). The model aircraft must be equipped with a lighting system which clearly defines the aircraft's attitude and direction at all times.
10. The operator of a radio-controlled model aircraft shall control it during the entire flight, maintaining visual contact without enhancement other than by corrective lenses that are prescribed for the pilot. No model aircraft shall be equipped with devices which allow it to be flown to a selected location which is beyond the visual range of the pilot.

Aeronca Champ 15e

Safe Operating Recommendations

- Inspect your model before every flight to make certain it is airworthy.
- Be aware of any other radio frequency user who may present an interference problem.
- Always be courteous and respectful of other users of your selected flight area.
- Choose an area clear of obstacles and large enough to safely accommodate your flying activity.
- Make certain this area is clear of friends and spectators prior to launching your aircraft.
- Be aware of other activities in the vicinity of your flight path that could cause potential conflict.
- Carefully plan your flight path prior to launch.
- Abide by any and all established AMA National Model Aircraft Safety Code.



© 2010 Horizon Hobby, Inc.
horizonhobby.com
www.e-fliterc.com