

**PETER  
GOLDSMITH**  
*design*

# Diamante 25e ARF

Assembly Manual

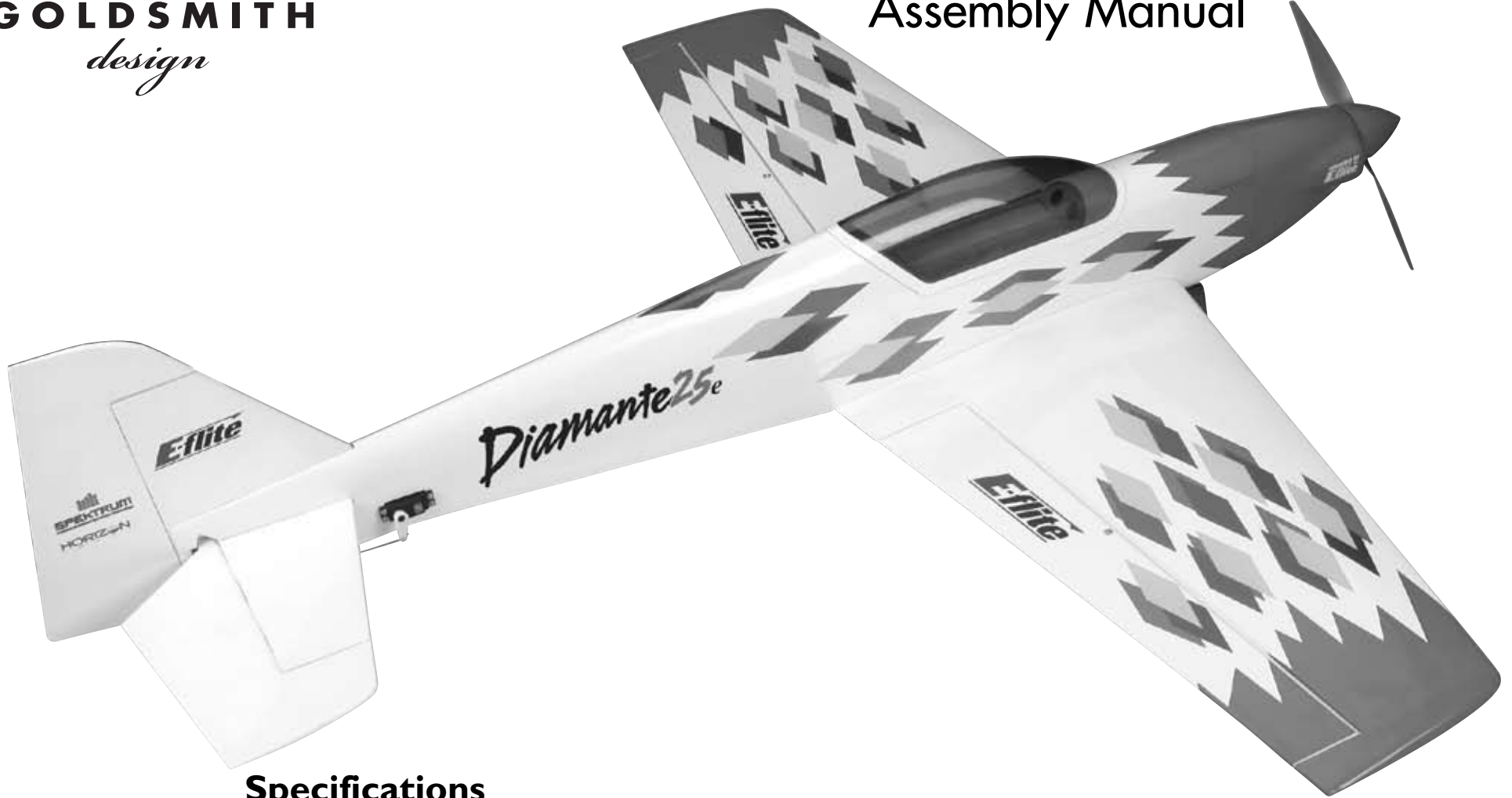

## Specifications

---

Wingspan:	48 in (1200mm)
Length:	50 in (1250mm)
Wing Area:	485 sq in (31.3 sq dm)
Weight w/o Battery:	3-3.3 lb (1.4-1.5 kg)
Weight w/ Battery:	3.6-4.2 lb (1.6-1.9 kg)

***E-flite***<sup>®</sup>  
**ADVANCING ELECTRIC FLIGHT**

## Table of Contents

Specifications .....	1
Introduction.....	2
Using the Manual.....	2
Contents of Kit/Parts Layout.....	3
Required Radio Equipment.....	3
Important Information About Motor Selection .....	3
Lightweight Sport Setup .....	4
Recommended High Power Precision Aerobatic Setup .....	4
Alternative Sport and Precision Setup .....	4
Optional Accessories .....	4
Note on Lithium Polymer Batteries .....	4
Required Tools and Adhesives .....	5
Warning .....	5
Warranty Period .....	5
Limited Warranty .....	6
Damage Limits .....	6
Safety Precautions .....	6
Questions, Assistance, and Repairs .....	7
Inspection or Repairs .....	7
Warranty Inspection and Repairs .....	7
Non-Warranty Repairs .....	7
Safety, Precautions, and Warnings .....	8
Aileron Installation .....	8
Landing Gear Installation.....	14
Horizontal and Vertical Tail Installation .....	17
Motor Installation .....	24
Final Assembly.....	27
Control Throws.....	28
Center of Gravity .....	29
Range Test Your Radio .....	29
Preflight .....	29
Flying the Diamante 25e.....	30
Reduce Your Workload.....	30
Servo and Control Setup.....	31
Sequencing.....	32
Balance .....	32
Dynamic Balance .....	33
Thrust Angles .....	33
Differential.....	34
Programmable Mixing.....	35
2007 Official AMA National Model Aircraft Safety Code .....	38
Building and Flying Notes.....	39

## Introduction

Thank you for purchasing the E-flite® Diamante 25e ARF. The Diamante 25e was designed by champion pilot Peter Goldsmith to provide intermediate to experienced pilots a precision aerobatics platform that is excellently balanced stability and has benign stall characteristics. At the heart of this design is the SD8020 airfoil that provides excellent tracking and crisp response in any axis. It is also extremely resistant to accelerated stalls so you'll feel like you're on rails in any attitude. Construction is balsa and light ply with a custom Peter Goldsmith UltraCote® trim scheme. The fiberglass cowl and wheel pants come painted from the factory. You will find two sets of mounting holes on the firewall to mount your choice of either the Power 25 or 32 Outrunner motors. The Power 32 is recommended if you wish to fly aggressive artistic aerobatics along with sport and precision flying. The Power 25 is ideal for sport aerobatics.

This model was purposely designed for electric power application from the ground up. The flight characteristics of this design are such that it will reach a large cross section of skills. Whether you are just learning to explore the aerobatic realm, or a more experienced pilot, the Diamante 25e will touch your skills with a low level of intimidation. The Diamante 25e was designed to be a straightforward, pure flying aerobatic performer. Much attention was spent developing the flight forces in all 3 axes ensuring minimum coupling, meaning a lower workload for the pilot.

## Using the Manual

This manual is divided into sections to help make assembly easier to understand, and to provide breaks between each major section. In addition, check boxes have been placed next to each step to keep track of each step completed. Steps with a single circle (○) are performed once, while steps with two circles (○ ○) indicate that the step will require repeating, such as for a right or left wing panel, two servos, etc.

Remember to take your time and follow the directions.

## Contents of Kit/Parts Layout

### Large Replacement Parts

EFL4051	Wing w/Ailerons:
EFL4052	Fuselage
EFL4053	Tail Set
EFL4055	Main Landing Gear
EFL4056	Cowling
EFL4057	Wheel Pants
EFL4058	Canopy
EFL4059	Spinner

### Small Replacement Parts

EFL4054	Pushrod Set
EFLA213	E-flite/JR/Horizon Decals

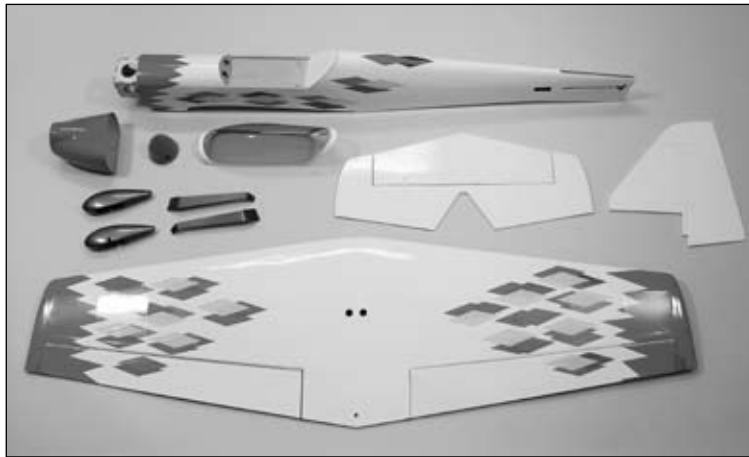

## Required Radio Equipment

You will need a minimum 6-channel transmitter, crystals, micro receiver, and four mini servos. You can choose to purchase a complete radio system that includes all of these items or, if you are using an existing transmitter, just purchase the other required equipment separately.

**Note:** We recommend the crystal-free, interference-free Spektrum® DX7 2.4GHz DSM®2 7-channel radio. The complete system includes standard servos, which are not required for the Diamante.

### Purchase Separately

SPM6070 DSM2 7-Channel Receiver

**Or**

JRPR720 7-Channel ScanSelect™ FM Receiver

**Or**

JRPR790 7-Channel ScanSelect PCM Receiver  
JSP98110 6" Servo Extension (2)  
JSP20040 MN48 Mini Servo (4)  
JSP98020 Y-harness, Standard 6"

**Note:** When using our recommended E-flite 60A Pro Brushless ESC with switching BEC you do not need a separate receiver pack as long as you are using our recommended servos.

**Note:** Depending on what speed control you are using, if it is not capable of supporting four mini-size servos because of current draw, the speed control may shut down due to high heat.

In order to provide the most reliable product, E-flite recommends the use of a separate BEC (like the Ultimate BEC), or receiver pack and switch using the following items to ensure trouble-free operation:

EXRB100 Expert 720mAh Ni-MH 4.8V Rx Pack  
EXRA050 Expert Standard Switch

## Important Information About Motor Selection

---

The Diamante 25e does not include a propeller. We are recommending the Power 25 or Power 32 outrunner motors.

The motor systems listed will provide you with excellent aerobatic power for sport and/or artistic aerobatic pilots. All power systems listed include worry-free outrunner motors.

### Lightweight Sport Setup

---

EFLM4025A	Power 25 BL Outrunner, 870Kv
EFLA1060	60A Pro Brushless ESC w/Switching BEC
THP42003S2PPL	4200mAh 3S2P 11.1V Li-Po, 13GA
APC12080E	Electric Propeller, 12x8E
EFLC3005	Celectra 1- to 3-cell Li-Po Charger
EFLAEC303	EC3 Dev & Batt, Male/Female

This is a sport aerobatic setup with limited precision capabilities.

### Recommended High Power Precision Aerobatic Setup

---

EFLM4032A	Power 32 BL Outrunner, 770Kv
EFLA1060	60A Pro Brushless ESC w/Switching BEC
THP42004S2PPL	4200mAh 4S2P 14.8V Li-Po, 13GA
APC13065E	Electric Propeller, 13x6.5E
EFLAEC303	EC3 Dev & Batt, Male/Female

This is our recommended setup. Expect high power precision aerobatics and very strong aggressive artistic aerobatics performance.

## Alternative Sport and Precision Setup

---

EFLM4032A	Power 32 BL Outrunner, 770Kv
THP42003S2PPL	4200mAh 3S2P 11.1V Li-Po, 13GA
APC14070E	Electric Propeller, 14x7E

**Or**

EFLM4025A	Power 25 BL Outrunner, 870Kv
THP42004S2PPL	4200mAh 4S2P 14.8V Li-Po, 13GA
APC12060E	Electric Propeller, 12x6E

**And**

EFLA1060	60A Pro Brushless ESC w/Switching BEC
EFLAEC303	EC3 Dev & Batt, Male/Female

This is an alternative sport and precision aerobatic setup and is a good option if you have some equipment and do not want to purchase additional. Both options are very similar in performance; you should expect better performance than our lightweight sport setup and less performance than with our recommended high power precision setup.

### Optional Accessories

---

EFLA110	Power Meter
HAN172	Hangar 9 Digital Servo and Rx Current Meter

### Note on Lithium Polymer Batteries

---



Lithium Polymer batteries are significantly more volatile than alkaline or Ni-Cd/Ni-MH batteries used in RC applications. All manufacturer's instructions and warnings must be followed closely. Mishandling of Li-Po batteries can result in fire. Always follow the manufacturer's instructions when disposing of Lithium Polymer batteries.

## Required Tools and Adhesives

---

### **Tools & Equipment**

EFLA250 Park Flyer Tool Assortment, 5-piece

### **Or Purchase Separately**

EFLA257 Screwdriver, #0 Phillips (or included with EFLA250)

EFLA251 Hex Wrench: 3/32", 7/64" (or included with EFLA250)

Nut driver: 5/16"

Drill

Drill bit: 1/16" (1.5mm), 5/64" (2mm),  
9/64" (3.5mm), 1/4" (6mm)

Hobby knife

Felt-tipped pen

Pliers

Rotary tool

T-pins

String

Thin CA

Weight

Pen Drill

Threadlock

#1 Phillips screwdriver

6-minute epoxy

Paper towel

Rubbing alcohol

Petroleum jelly

Canopy glue

Square

Sandpaper

Masking tape

## Warning

---

An RC aircraft is not a toy! If misused, it can cause serious bodily harm and damage to property. Fly only in open areas, preferably at AMA (Academy of Model Aeronautics) approved flying sites, following all instructions included with your radio.

Keep loose items that can get entangled in the propeller away from the prop, including loose clothing, or other objects such as pencils and screwdrivers. Especially keep your hands away from the propeller.

## Warranty Period

---

Horizon Hobby, Inc., (Horizon) warrants that the Products purchased (the "Product") will be free from defects in materials and workmanship at the date of purchase by the Purchaser.

## Limited Warranty

---

(a) This warranty is limited to the original Purchaser ("Purchaser") and is not transferable. REPAIR OR REPLACEMENT AS PROVIDED UNDER THIS WARRANTY IS THE EXCLUSIVE REMEDY OF THE PURCHASER. This warranty covers only those Products purchased from an authorized Horizon dealer. Third party transactions are not covered by this warranty. Proof of purchase is required for warranty claims. Further, Horizon reserves the right to change or modify this warranty without notice and disclaims all other warranties, express or implied.

(b) Limitations- HORIZON MAKES NO WARRANTY OR REPRESENTATION, EXPRESS OR IMPLIED, ABOUT NON-INFRINGEMENT, MERCHANTABILITY OR FITNESS FOR A PARTICULAR PURPOSE OF THE PRODUCT. THE PURCHASER ACKNOWLEDGES THAT THEY ALONE HAVE DETERMINED THAT THE PRODUCT WILL SUITABLY MEET THE REQUIREMENTS OF THE PURCHASER'S INTENDED USE.

(c) Purchaser Remedy- Horizon's sole obligation hereunder shall be that Horizon will, at its option, (i) repair or (ii) replace, any Product determined by Horizon to be defective. In the event of a defect, these are the Purchaser's exclusive remedies. Horizon reserves the right to inspect any and all equipment involved in a warranty claim. Repair or replacement decisions are at the sole discretion of Horizon. This warranty does not cover cosmetic damage or damage due to acts of God, accident, misuse, abuse, negligence, commercial use, or modification of or to any part of the Product. This warranty does not cover damage due to improper installation, operation, maintenance, or attempted repair by anyone other than Horizon. Return of any goods by Purchaser must be approved in writing by Horizon before shipment.

## Damage Limits

---

HORIZON SHALL NOT BE LIABLE FOR SPECIAL, INDIRECT OR CONSEQUENTIAL DAMAGES, LOSS OF PROFITS OR PRODUCTION OR COMMERCIAL LOSS IN ANY WAY CONNECTED WITH THE PRODUCT, WHETHER SUCH CLAIM IS BASED IN CONTRACT, WARRANTY, NEGLIGENCE, OR STRICT LIABILITY. Further, in no event shall the liability of Horizon exceed the individual price of the Product on which liability is asserted. As Horizon has no control over use, setup, final assembly, modification or misuse, no liability shall be assumed nor accepted for any resulting damage or injury. By the act of use, setup or assembly, the user accepts all resulting liability.

If you as the Purchaser or user are not prepared to accept the liability associated with the use of this Product, you are advised to return this Product immediately in new and unused condition to the place of purchase.

Law: These Terms are governed by Illinois law (without regard to conflict of law principals).

## Safety Precautions

---

This is a sophisticated hobby Product and not a toy. It must be operated with caution and common sense and requires some basic mechanical ability. Failure to operate this Product in a safe and responsible manner could result in injury or damage to the Product or other property. This Product is not intended for use by children without direct adult supervision. The Product manual contains instructions for safety, operation and maintenance. It is essential to read and follow all the instructions and warnings in the manual, prior to assembly, setup or use, in order to operate correctly and avoid damage or injury.

## Questions, Assistance, and Repairs

Your local hobby store and/or place of purchase cannot provide warranty support or repair. Once assembly, setup or use of the Product has been started, you must contact Horizon directly. This will enable Horizon to better answer your questions and service you in the event that you may need any assistance. For questions or assistance, please direct your email to [productsupport@horizonhobby.com](mailto:productsupport@horizonhobby.com), or call 877.504.0233 toll free to speak to a service technician.

## Inspection or Repairs

If this Product needs to be inspected or repaired, please call for a Return Merchandise Authorization (RMA). Pack the Product securely using a shipping carton. Please note that original boxes may be included, but are not designed to withstand the rigors of shipping without additional protection. Ship via a carrier that provides tracking and insurance for lost or damaged parcels, as **Horizon is not responsible for merchandise until it arrives and is accepted at our facility**. A Service Repair Request is available at [www.horizonhobby.com](http://www.horizonhobby.com) on the "Support" tab. If you do not have internet access, please include a letter with your complete name, street address, email address and phone number where you can be reached during business days, your RMA number, a list of the included items, method of payment for any non-warranty expenses and a brief summary of the problem. Your original sales receipt must also be included for warranty consideration. Be sure your name, address, and RMA number are clearly written on the outside of the shipping carton.

## Warranty Inspection and Repairs

**To receive warranty service, you must include your original sales receipt** verifying the proof-of-purchase date. Provided warranty conditions have been met, your Product will be repaired or replaced free of charge. Repair or replacement decisions are at the sole discretion of Horizon Hobby.

## Non-Warranty Repairs

**Should your repair not be covered by warranty the repair will be completed and payment will be required without notification or estimate of the expense unless the expense exceeds 50% of the retail purchase cost.** By submitting the item for repair you are agreeing to payment of the repair without notification. Repair estimates are available upon request. You must include this request with your repair. Non-warranty repair estimates will be billed a minimum of ½ hour of labor. In addition you will be billed for return freight. Please advise us of your preferred method of payment. Horizon accepts money orders and cashiers checks, as well as Visa, MasterCard, American Express, and Discover cards. If you choose to pay by credit card, please include your credit card number and expiration date. Any repair left unpaid or unclaimed after 90 days will be considered abandoned and will be disposed of accordingly. **Please note: non-warranty repair is only available on electronics and model engines.**

Electronics and engines requiring inspection or repair should be shipped to the following address:

Horizon Service Center  
4105 Fieldstone Road  
Champaign, Illinois 61822

All other Products requiring warranty inspection or repair should be shipped to the following address:

Horizon Product Support  
4105 Fieldstone Road  
Champaign, Illinois 61822

**Please call 877-504-0233 with any questions or concerns regarding this product or warranty.**

## Safety, Precautions, and Warnings

As the user of this product, you are solely responsible for operating it in a manner that does not endanger yourself and others or result in damage to the product or the property of others.

Carefully follow the directions and warnings for this and any optional support equipment (chargers, rechargeable battery packs, etc.) that you use.

This model is controlled by a radio signal that is subject to interference from many sources outside your control. This interference can cause momentary loss of control so it is necessary to always keep a safe distance in all directions around your model, as this margin will help to avoid collisions or injury.

- Always operate your model in an open area away from cars, traffic, or people.
- Avoid operating your model in the street where injury or damage can occur.
- Never operate the model out into the street or populated areas for any reason.
- Never operate your model with low transmitter batteries.
- Carefully follow the directions and warnings for this and any optional support equipment (chargers, rechargeable battery packs, etc.) that you use.
- Keep all chemicals, small parts and anything electrical out of the reach of children.
- Moisture causes damage to electronics. Avoid water exposure to all equipment not specifically designed and protected for this purpose.

## Aileron Installation

### Required Parts

- Wing
- Servo w/hardware (2)
- CA hinge (8)
- Clevis (2)
- Nylon control horn (2)
- Control horn standoff (2)
- Pushrod wire connector (2)
- Servo extension, 6 in (152mm) (2)
- Receiver
- Long servo arm (2)
- 3<sup>3</sup>/<sub>8</sub> in (86mm) pushrod wire (2)
- Clevis retainer (2)
- 3mm x 30mm machine screw (2)
- Control horn washer (2)

### Required Tools and Adhesives

- Rotary tool
- T-pins
- String
- Felt-tipped pen
- Threadlock
- #1 Phillips screwdriver
- Drill bit: 1/16 in (1.5mm)
- Thin CA
- Weight
- Pen drill
- Tape

- ○ 1. Locate four CA hinges. Place a T-pin in the center of each hinge.

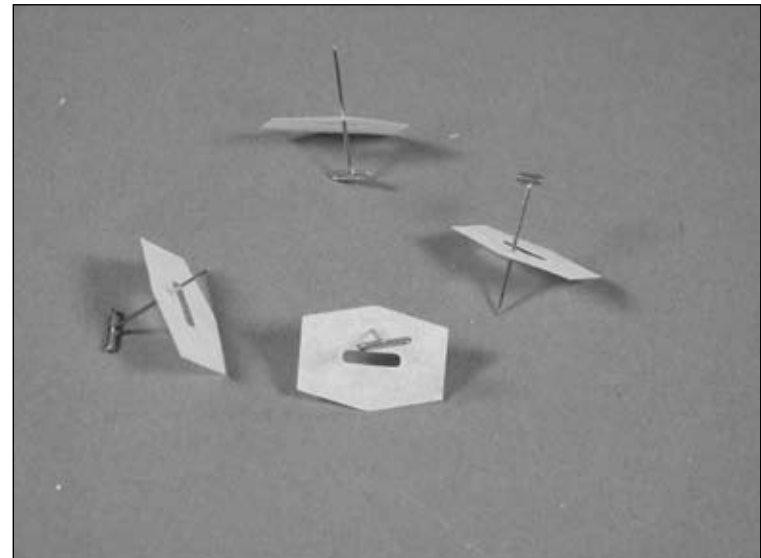



- ○ 2. Use a rotary tool and a 1/16 in (1.5mm) drill bit to drill a hole in the center of each hinge slot of both the aileron and wing. This provides a tunnel for the CA to wick into, penetrating the hinge.



**Hint:** You can prepare the rudder, fin, elevator and stabilizer at this time as well.

- ○ 3. Slide the four hinges into the slots in the aileron.



- ○ 4. Slide the aileron into position on the wing. The T-pins installed back in Step 1 will help in keeping equal amounts in the wing and aileron.

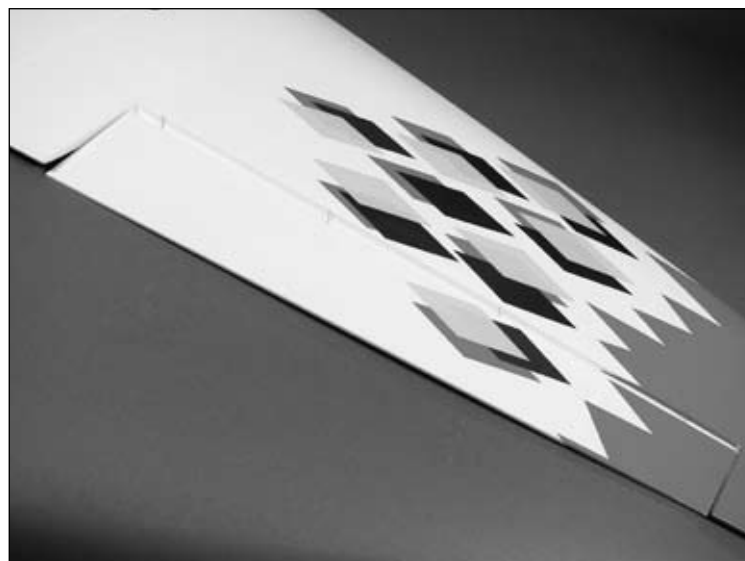

- ○ 5. Apply a few drops onto each hinge. Make sure to apply the CA on both the top and bottom of the hinge.



**Important:** Do not use accelerator on the hinges. The CA must be allowed to soak in and penetrate the hinge.

- ○ 6. Gently pull the aileron from the wing once the CA has fully cured. This is to verify the hinges are glued securely.



- ○ 7. Flex the aileron through its range of motion a few times to break in the hinges.



- 8. Repeat Steps 1 through 7 to complete the aileron installation.

- ○ 9. Install the servo grommets and brass eyelets onto the aileron servo following the instructions provided with the servo. Attach a 6 in (152mm) servo extension to the aileron servo. Use a commercially available clip to keep the two from becoming disconnected inside the wing.

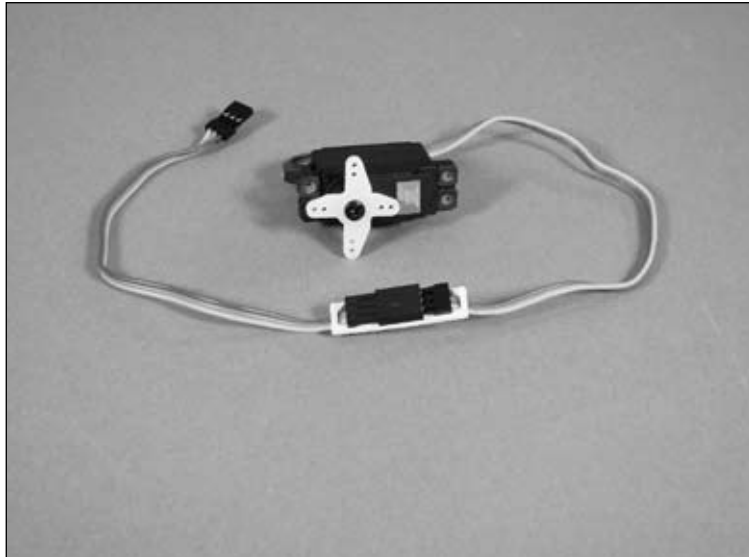

- ○ 10. Tie the string to the extension installed on the aileron servo. Pull the extension through the wing and out the hole in the center. Use tape to secure the extension to the wing and prevent it from falling back into the wing.

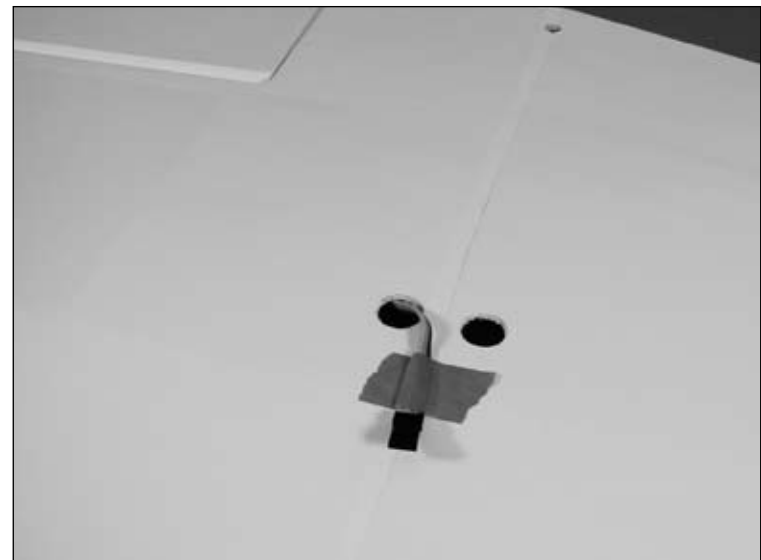
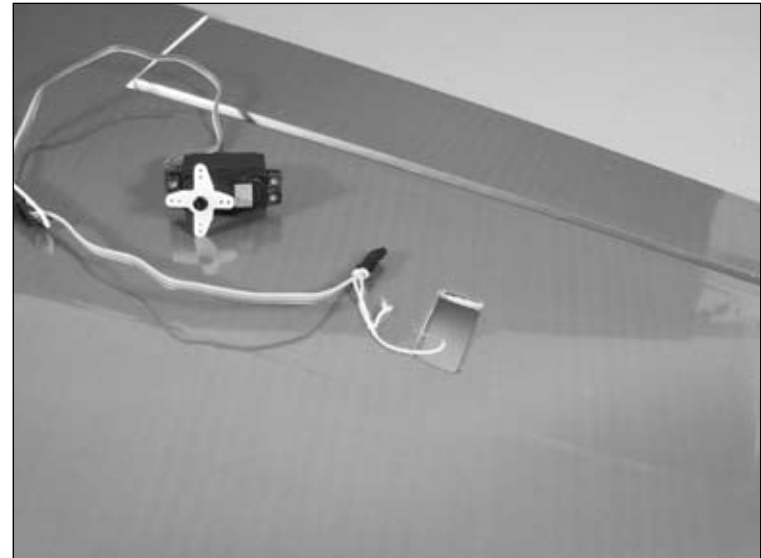

- ○ 11. Place the servo into the opening in the wing. Use a felt-tipped pen to mark the locations for the servo mounting screws.



- ○ 12. Use a pen drill and 1/16 in (1.5mm) drill bit to drill the four locations for the servo mounting screws.

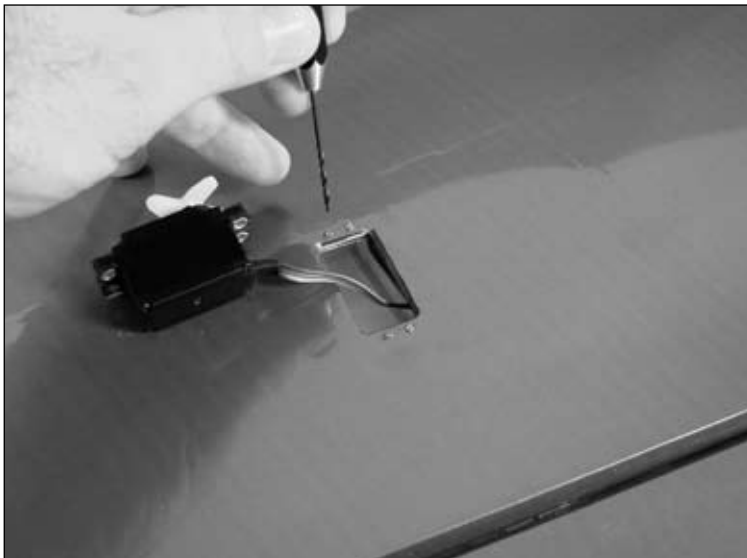

- ○ 13. Apply a few drops of thin CA to each of the four holes. This will harden the underlying wood and help in preventing the screws from pulling out.



- ○ 14. Secure the servo in the wing using the screws provided with the servo. Note the servo horn faces towards the aileron.

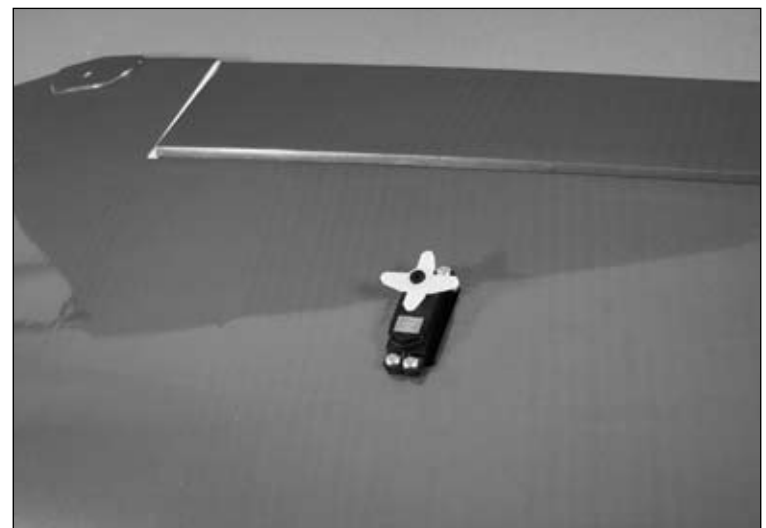

- ○ 15. Use a hobby knife to pierce the covering for the 3mm x 30mm machine screw. Slide the screw into the hole from the top of the wing. Slide a control horn washer onto the screw, then thread the control horn standoff onto the screw. Use a #1 Phillips screwdriver to tighten the assembly.

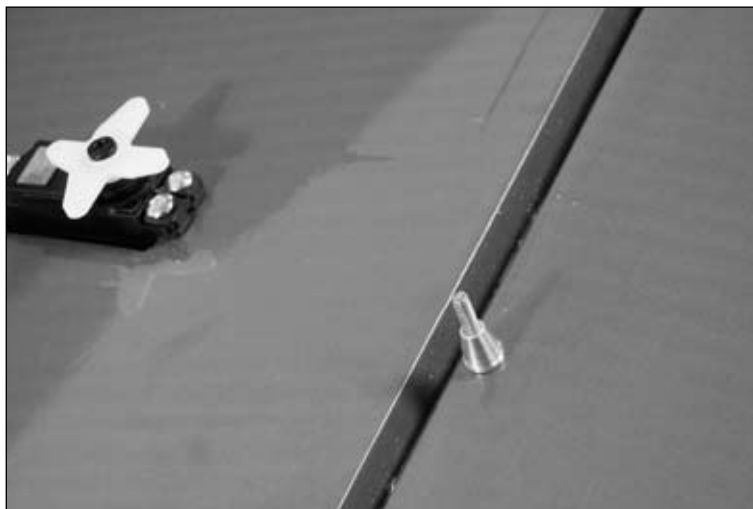
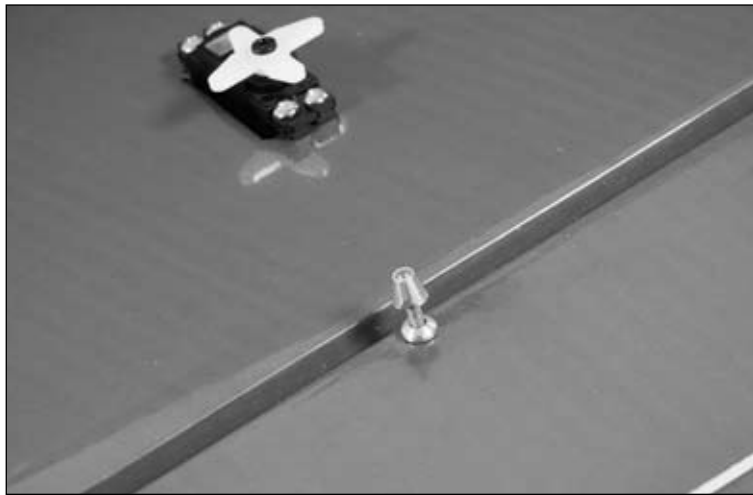

**Note:** Use threadlock on the screw to prevent it from vibrating loose.

- ○ 16. Thread the nylon control horn onto the control horn screw until the top of the horn is flush with the top of the screw.

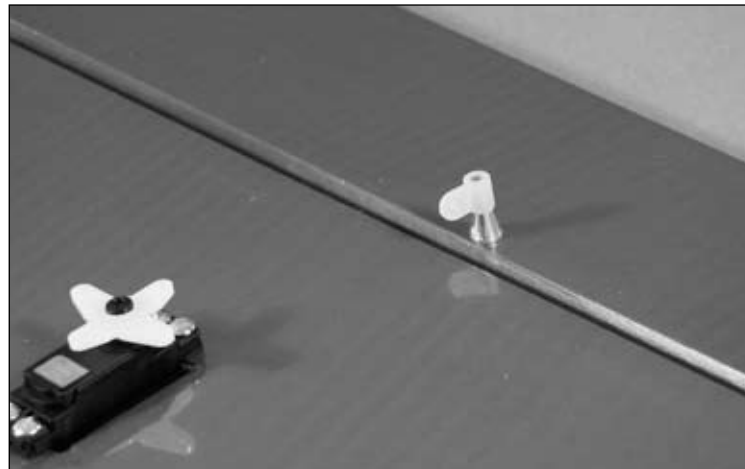

- ○ 17. Slide a clevis retainer onto a nylon clevis. Thread the clevis onto the  $3\frac{3}{8}$  in (86mm) pushrod wire. Attach the clevis to the control horn and slide the clevis retainer over the forks of the clevis to secure it to the control horn.

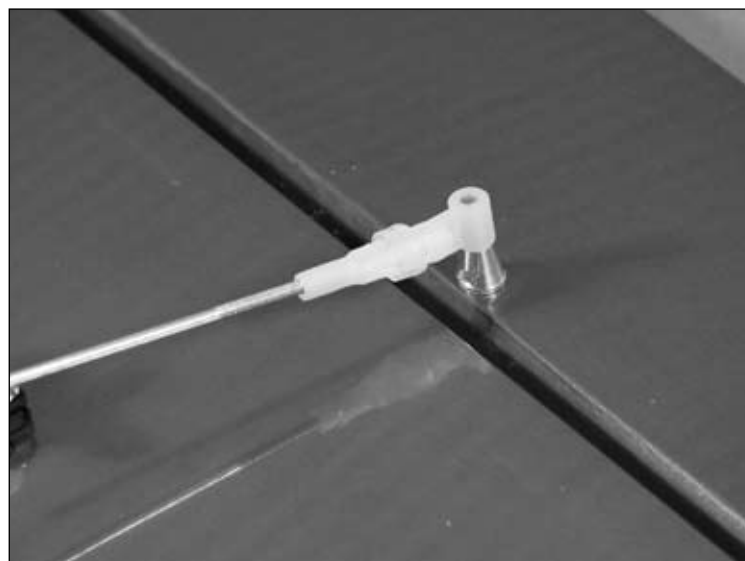

- ○ 18. Plug the servo into the receiver and power up the radio system. Center the aileron stick and trim. Install a long servo arm onto the servo, parallel to the aileron hinge line. Mark the pushrod wire where it crosses the servo horn using a felt-tipped pen.

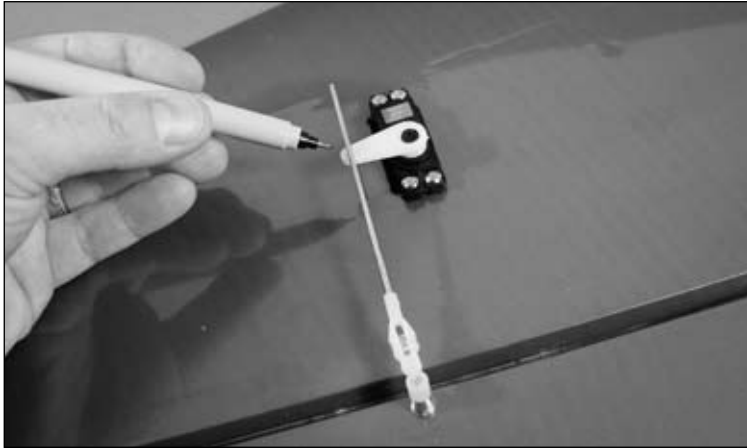

- ○ 19. Bend the wire 90 degrees at the mark made in the last step. Use a pushrod wire connector to secure the wire to the servo arm. Trim any excess wire using side cutters.

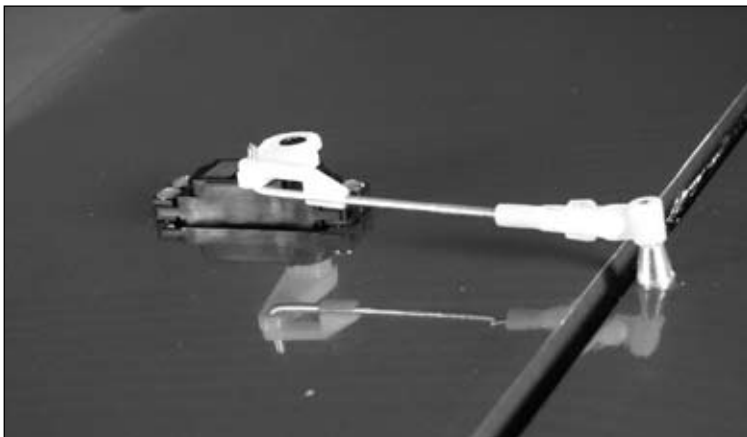

- ○ 20. Repeat Steps 9 through 19 to complete the aileron servo installation.

## Landing Gear Installation

### Required Parts

- Fuselage
- 2 1/4 in (57mm) wheel (2)
- 6-32 lock nuts (6)
- #6 washer (4)
- 4-40 blind nut (2)
- 6-32 x 3/8" socket head screws (4)
- Landing gear (left and right)
- Wheel pant (left and right)
- 6-32 x 1 1/8" machine screw (2)
- 4-40 x 1/2" machine screw (2)

### Required Tools and Adhesives

- Drill
- Adjustable wrench
- #1 Phillips screwdriver
- Felt-tipped pen
- Drill bit: 9/64 in (3.5mm)
- Adjustable pliers
- Hex wrench: 3/32", 7/64"

- ○ 1. Attach the landing gear to the bottom of the fuselage using four 6-32 x 3/8" socket head screws. The gear will only go on in one direction.

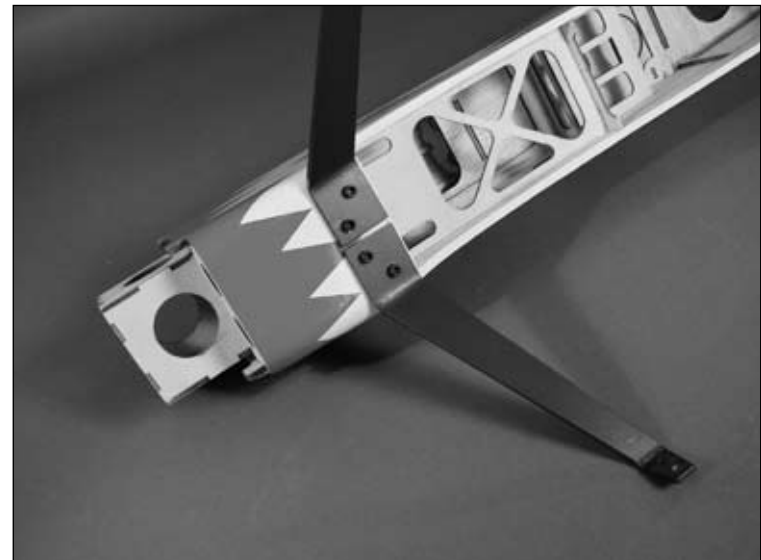

- ○ 2. Slide the 6-32 x 1<sup>1</sup>/<sub>8</sub>" machine screw through the bottom hole of the landing gear. Secure the screw using a 6-32 lock nut. Thread a second lock nut onto the screw.

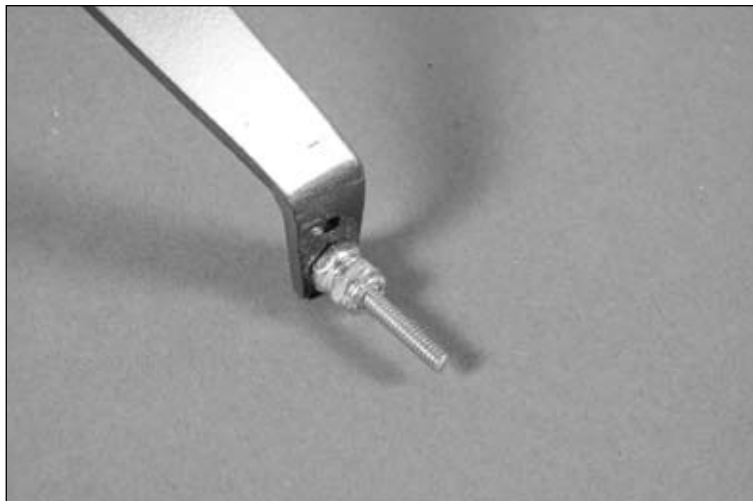

- ○ 3. Slide a #6 washer onto the screw, then slide the wheel onto the screw. Slide a second #6 washer onto the screw and secure the wheel using a 6-32 lock nut. Make sure the wheel can turn freely after installing the final nut.



- ○ 4. Test fit the wheel pant onto the landing gear. Sand the notch in the wheel pant if necessary so it fits over the lock nut that is against the landing gear.

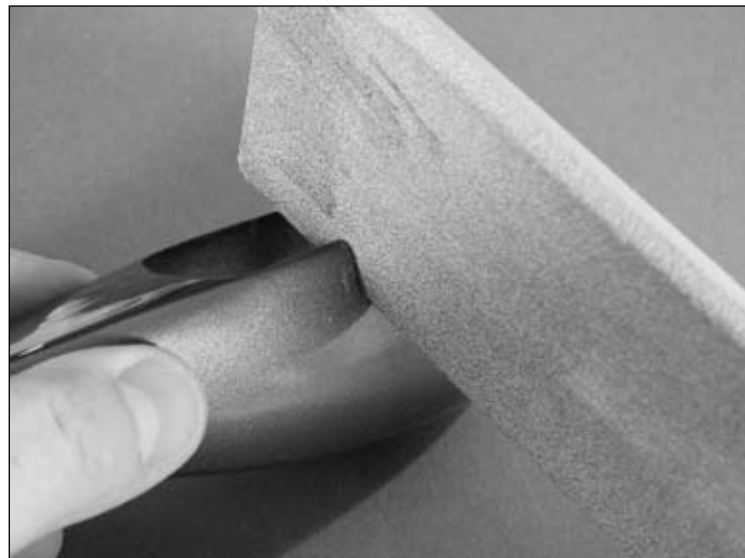

- ○ 5. Position the wheel pant so it is parallel to the top of the fuselage as shown.

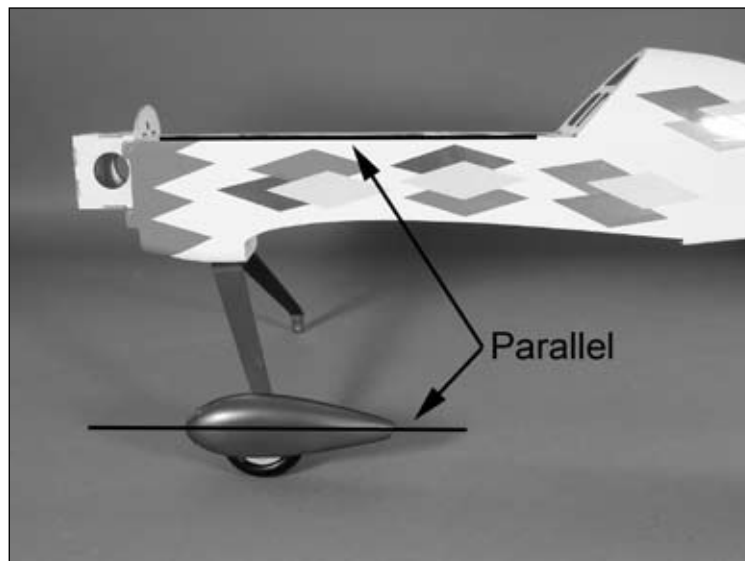

- ○ 6. Use a felt-tipped pen to transfer the location of the upper hole onto the wheel pant.



- ○ 7. Use a drill and 9/64 in (3.5mm) drill bit to drill the location made in the previous step.

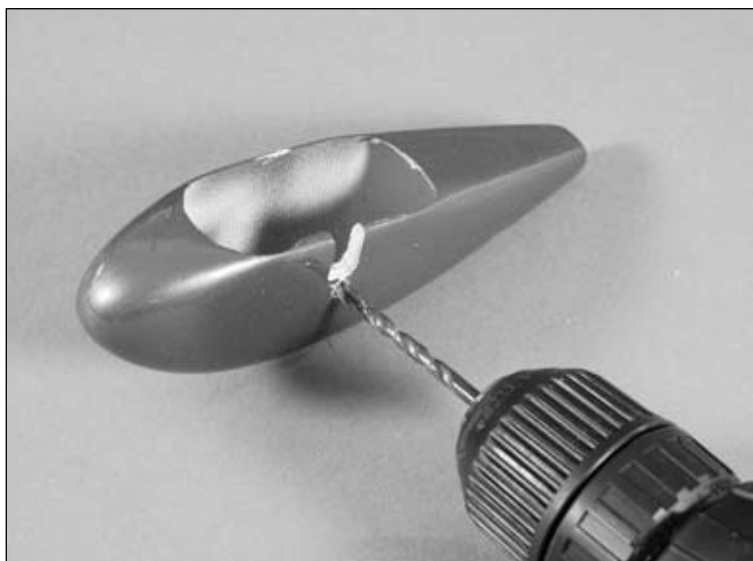

- ○ 8. Press the 4-40 blind nut into the hole from the inside of the wheel pant.

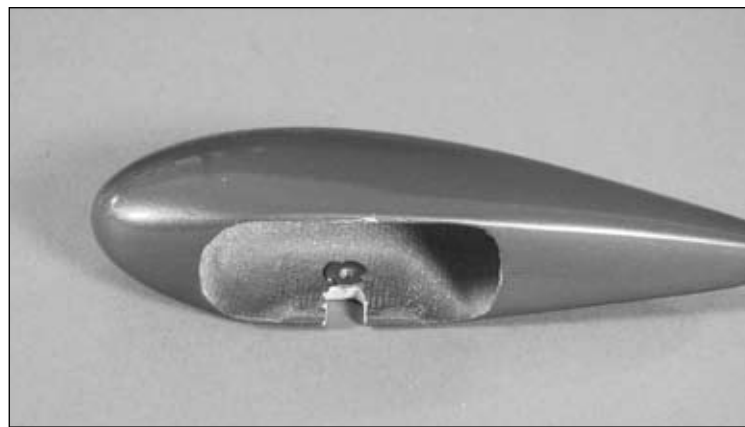

- ○ 9. Slide the wheel pant back onto the gear and secure using a 4-40 x 1/2" machine screw.



- 10. Repeat Steps 2 through 9 to install the remaining wheel and wheel pant.



## Horizontal and Vertical Tail Installation

### Required Parts

- Wing assembly
- Elevator
- Stabilizer
- Rudder
- 7 in (178mm) pushrod wire
- Clevis (2)
- Nylon control horn (2)
- Control horn standoff (2)
- Long servo horn (2)
- 1 in (25mm) tail wheel
- Servo extension, 12" (305mm) (2)
- 1 1/4 in x 1/4 in (32mm x 6mm) wing dowel (2)
- 10-32 nylon wing bolt
- Pushrod wire connector (2)
- Fin
- CA hinges (9)
- 6 1/4 in (159mm) pushrod wire
- Clevis retainer (2)
- 3mm x 30mm machine screw (2)
- Control horn washer (2)
- Tail gear assembly
- 3/32" wheel collar (2)

### Required Tools and Adhesives

- Drill
- 6-minute epoxy
- Ruler
- Thin CA
- Paper towel
- Hobby knife
- Petroleum jelly
- Drill bit: 1/4 in (6mm)
- String
- T-pins
- Rubbing alcohol
- Felt-tipped pen

1. Enlarge the holes in the leading edge of the wing using a drill and 1/4 in (6mm) drill bit.



2. Use 6-minute epoxy to glue the 1 1/4 in x 1/4 in (32mm x 6mm) wing dowels into the leading edge of the wing. Clean up any excess epoxy using a paper towel and rubbing alcohol. The dowels will protrude 3/8 in (10mm) forward of the wing.

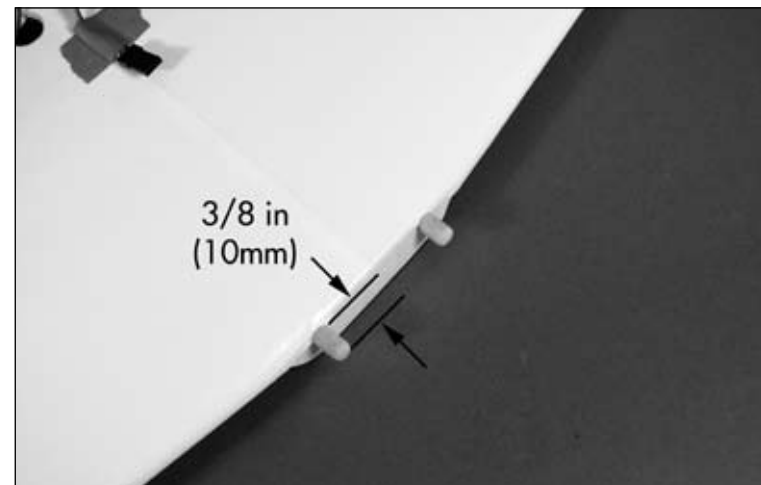

- 3. Attach the wing to the fuselage using the 10-32 nylon wing bolt.

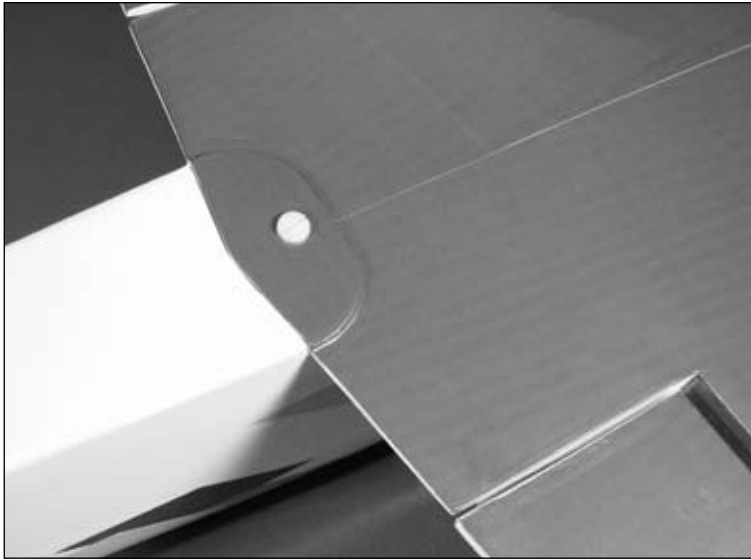

- 4. Use six CA hinges to attach the elevator and stabilizer. Use the same technique as the aileron hinges when installing the elevator hinges.

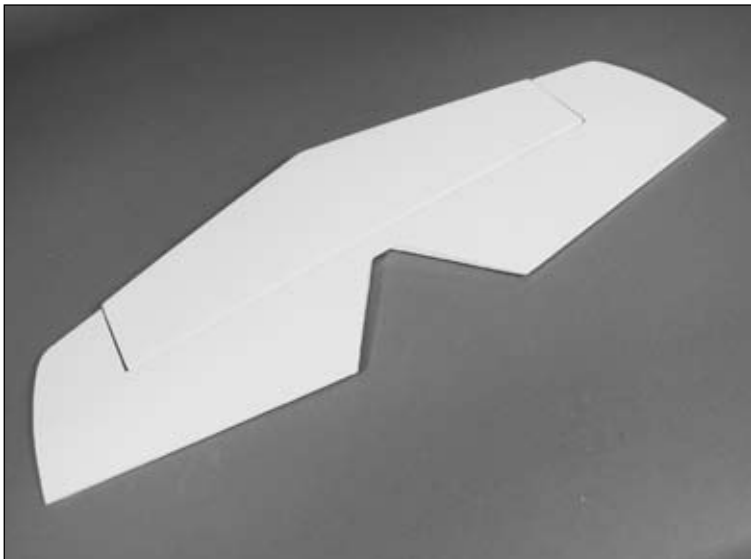

- 5. Install the elevator control horn as shown following the same technique as the aileron control horn. Note the position of the control horn.



- 6. Slide the stabilizer into the fuselage. Make sure the control horn faces toward the bottom of the fuselage. Measure the distance from the center of the fuselage to each stabilizer tip to center the stabilizer in the fuselage.

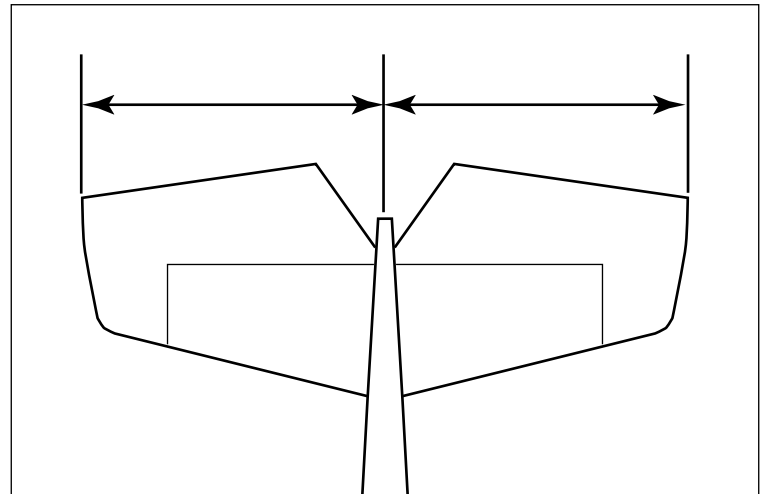

- 7. Measure from the wing tip to the stabilizer to make sure both measurements are equal. This will square the stabilizer to the wing and fuselage. Use a piece of string to check the distance between the wing and stabilizer.

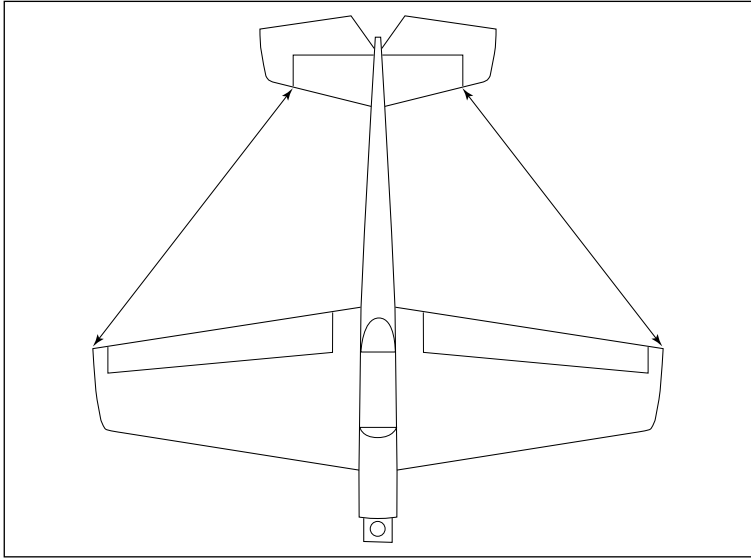

- 8. Check to make sure the stabilizer is parallel to the wing. Lightly sand the fuselage where the stabilizer rests to correct any alignment problems.

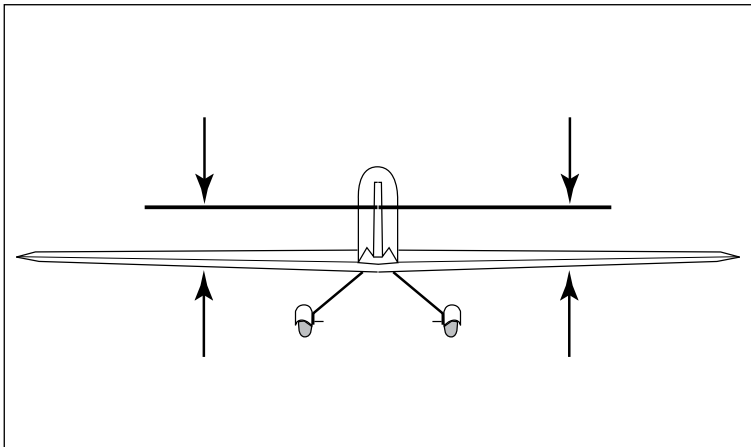

- 9. Use a felt-tipped pen to trace the outline of the fuselage on the top and bottom of the stabilizer once the stabilizer has been aligned.

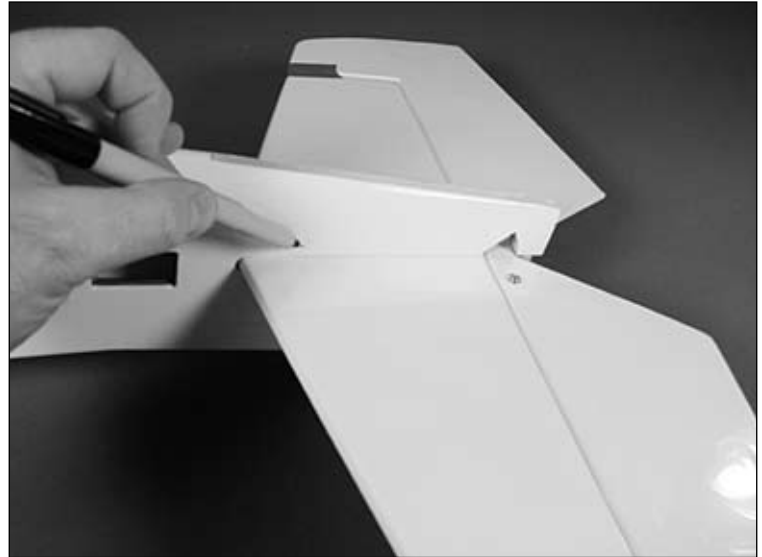

- 10. Use a hobby knife with a new blade to remove the covering slightly inside the lines drawn in the previous step.

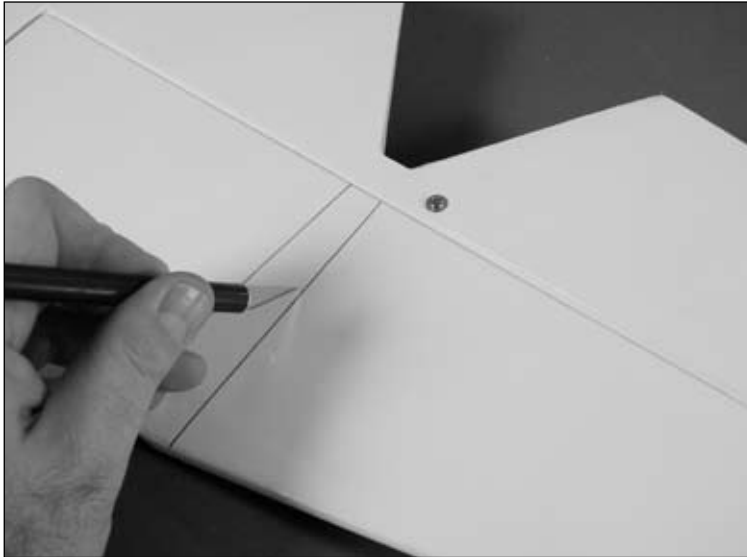

**Note:** Remove the covering from the top and bottom of the stabilizer.

**Important:** Use light pressure to remove the covering, as you can use too much pressure and score the stabilizer which could cause it to fail in flight.

**Hint:** You can use a soldering iron or hot knife as an option to a hobby knife. This will greatly lower the chances of cutting into the stabilizer.

- 11. Slide the stabilizer back into the fuselage and double-check the alignment. Wick thin CA into the joint between the fuselage and stabilizer. Avoid using CA accelerator on the CA to give it time to wick into the joint. Allow the CA to cure before handling the fuselage.

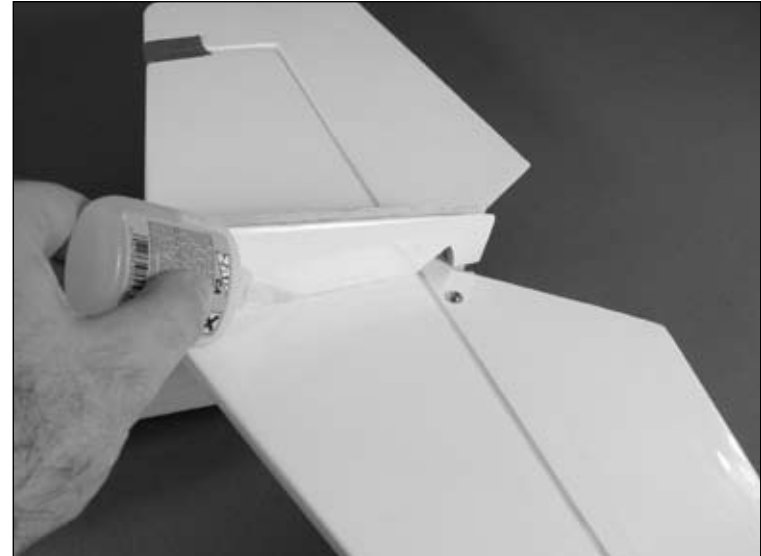

- 12. Locate the tail gear assembly and apply a thin coat of petroleum jelly to the wire. Work the bushing to distribute the jelly.

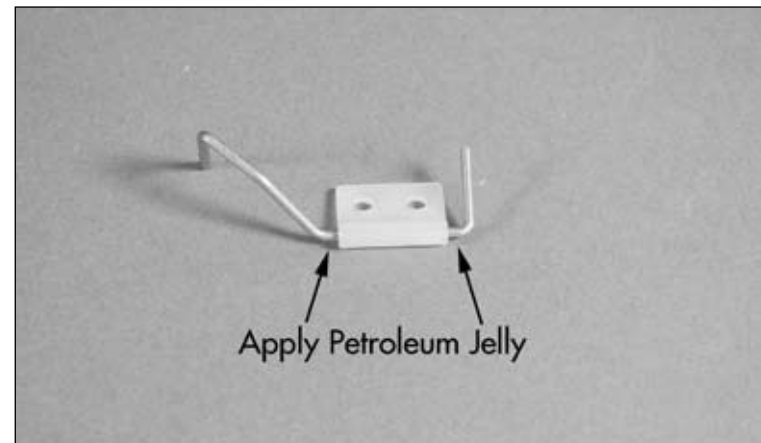

- 13. Use 6-minute epoxy to glue the tail wheel assembly into the pre-cut slot in the aft end of the fuselage.



- 14. Slide the fin into the slot in the aft end of the fuselage. Press the fin tight against the end of the fuselage, as it can rock forward in the slot.

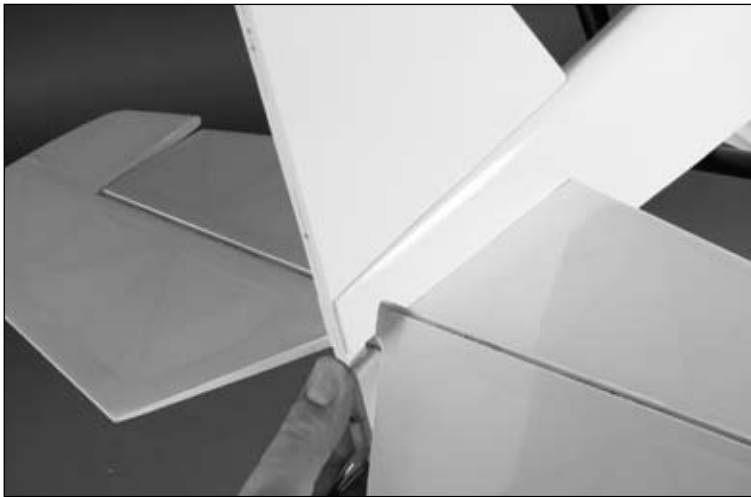

**Note:** The aft edge of the fin will be parallel to the aft end of the fuselage when positioned correctly.

- 15. Use a square to make sure the vertical fin is square to the stabilizer.



- 16. Use a felt-tipped pen to trace the outline of the fuselage onto the fin with the fin in correct alignment. Use a square to make sure the vertical fin is square to the stabilizer.



- 17. Remove the covering below the line drawn on the fin using the same technique as the stabilizer. Use thin CA to secure the fin to the fuselage.



- 18. Use three hinges to install the rudder onto the fin. The tail gear wire will be glued into the rudder using 6-minute epoxy.



- 19. Secure the tail wheel onto the tail gear assembly using two 3/32" wheel collars.



- 20. Install the rudder control horn using the same technique as the elevator and aileron control horns.



- 21. Attach a 12 in (305mm) servo extension to the rudder servo lead. Install the servo using the same technique as the aileron servo. Use the 7 in (178mm) pushrod wire to connect the servo to the rudder control horn.



- 22. Attach a 12 in (305mm) servo extension to the elevator servo lead. Install the servo using the same technique as the aileron servo. Use the 6<sup>1</sup>/<sub>4</sub> in (159mm) pushrod wire to connect the servo to the elevator control horn.



## Motor Installation

### Required Parts

- Fuselage assembly
- Hook and loop strap (2)
- Cowling
- Propeller
- Hook and loop tape, 3" (76mm) (2)
- 2mm x 10mm sheet metal screw (4)
- 4-40 blind nut (4)
- 4-40 x 1/2" socket head screws
- 2 1/2" (64mm) spinner
- Brushless ESC

### Required Tools and Adhesives

- Hex wrench: 3/32"
- Masking tape
- Card stock
- Drill bit: 1/16 in (1.5mm), 9/64 in (3.5mm)
- Drill

**Note:** There are two sets of holes in the firewall. The outer set of holes is used to mount the Power 32 motor, while the inner holes are used for mounting the Power 25 motor. Use the appropriate holes for your motor.

1. Use a drill and 9/64 in (3.5mm) drill bit to drill the holes in the motor mount for the mounting screws.



2. Attach the mount to the motor using the hardware provided with the motor.



3. Install the four 4-40 blind nuts inside the fuselage. Use the appropriate holes for your particular motor. Use four 4-40 x 1/2" socket head screws to secure the motor to the firewall.





- 3. Plug the motor into the speed control. Use hook and loop tape to secure the speed control inside the fuselage out of the way of the battery.

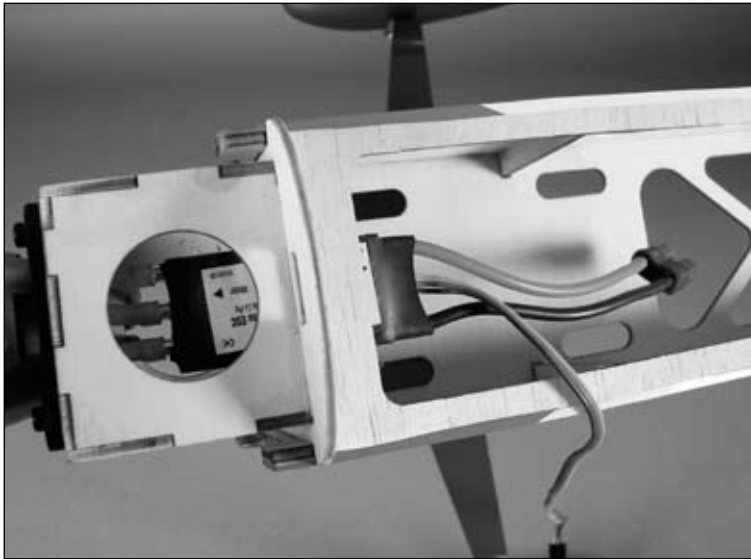

**Note:** When using our recommended E-flite™ 60A Pro Brushless ESC with switching BEC you do not need a separate receiver pack as long as you are using our recommended servos.

If your ESC is not capable of supporting the current draw of four mini-size servos the speed control may shut down due to high heat.

In order to provide the most reliable product, E-flite recommends the use of a separate BEC (like the Ultimate BEC), or receiver pack and switch to ensure trouble-free operation as follows:

Expert 720mAh Ni-MH 4.8V receiver battery (EXRB100)  
Expert Standard Switch (EXRA050)

Use the battery and switch harness to power the receiver and servos after disabling the BEC on the ESC (by following the instructions included with the ESC).

- 4. Use the two hook and loop straps included with your plane to secure the battery inside the fuselage.



**Note:** If the battery slides forward or backward, use hook and loop tape on the battery and inside the fuselage to prevent the battery from moving.

- 5. Now is a good time to test the operation of the motor. Use your radio system and plug the speed control into the receiver. With the battery plugged in, use the throttle stick to operate the motor. Check that the motor operates properly, and that it rotates counterclockwise when viewed from the front of the plane. Follow the instructions provided with the speed control to correct for operational problems.

- 6. Use tape and cardstock to make tabs to indicate the location of the tabs at the front of the fuselage for mounting the cowling.

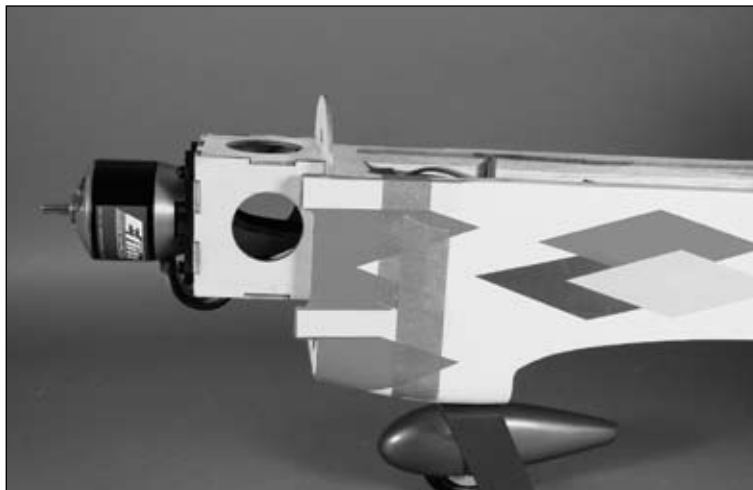

- 7. Slide the cowling onto the fuselage. Use the propeller adapter to attach the propeller and spinner backplate temporarily onto the motor. Position the cowling so it lines up with the spinner backplate, and has a small gap between the spinner backplate and cowling.

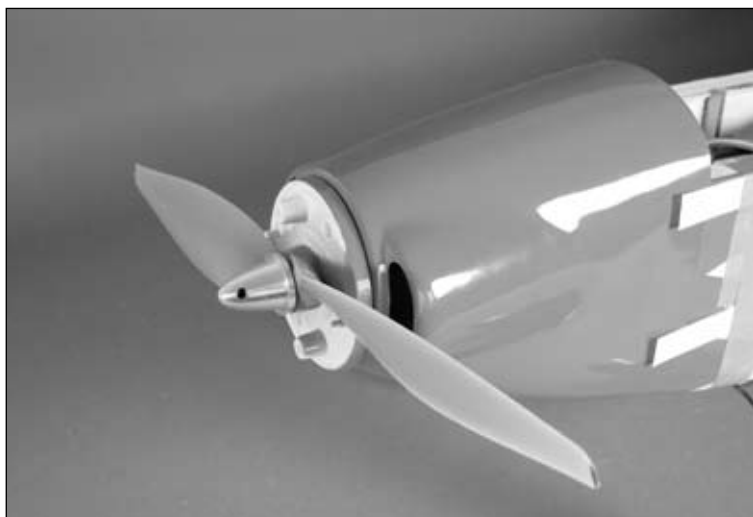

- 8. With the cowling aligned with the spinner, use a drill and 1/16 in (1.5mm) drill bit to drill through the cowling and into the fuselage using the cardstock as guides.

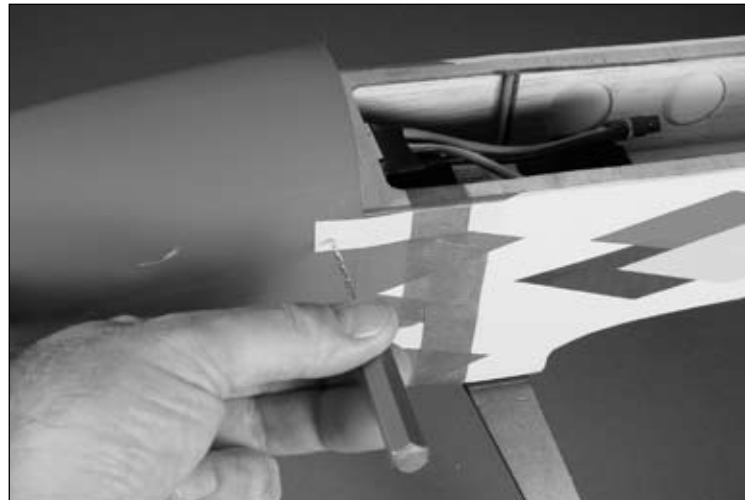

- 9. Secure the cowling using the four 2mm x 10mm sheet metal screws. There are two screws on each side of the cowl as shown. Complete the cowling installation by attaching the spinner cone using the two screws provided with the spinner.

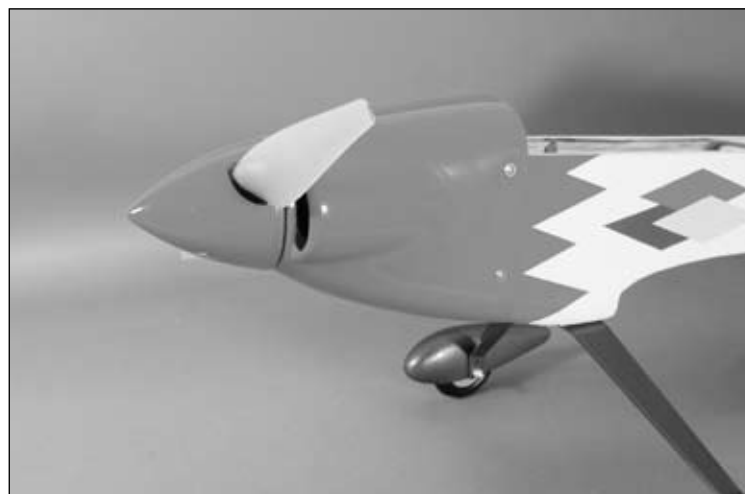

## Final Assembly

### Required Parts

- Fuselage assembly
- Receiver
- Canopy

### Required Tools and Adhesives

- Hook and loop tape
- Masking tape
- Canopy Glue (PAAPT56)
- Felt-tipped pen
- Sandpaper

- 1. Secure the receiver inside the fuselage using hook and loop tape. Follow the instructions provided with the receiver when installing the antenna.

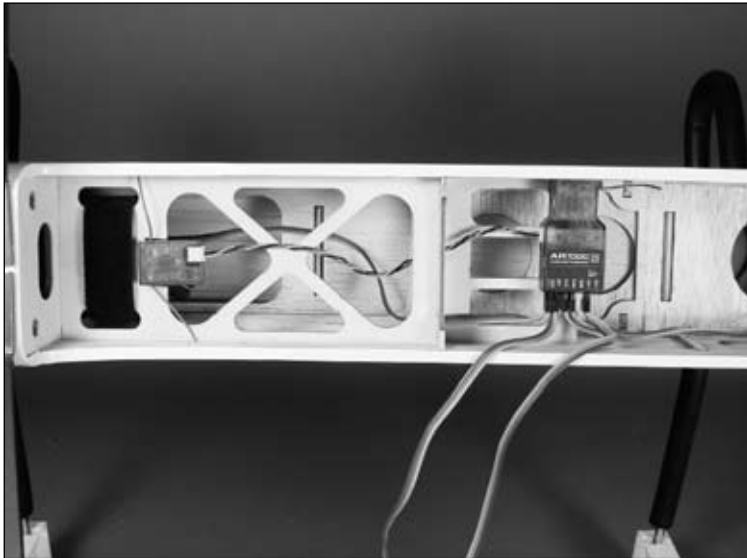

- 2. Place the canopy onto the hatch. Use a felt-tipped pen to trace the outline of the canopy onto the hatch.



**Note:** Use care not to change the position of the back of the canopy hatch.

- 2. Lightly sand the hatch inside the line drawn in the last step. Also sand the inside of the canopy where it contacts the hatch. Use rubbing alcohol and a paper towel to wipe down the two contacting surfaces.

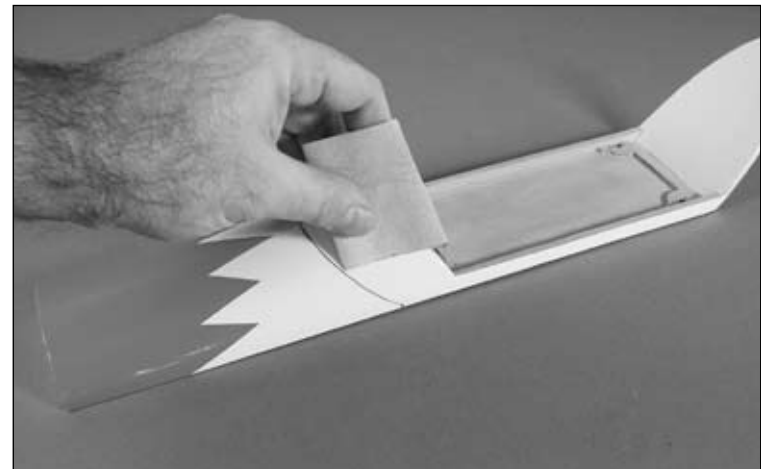

- 3. Use canopy glue to attach the canopy to the canopy hatch. Tape the canopy into position until the glue fully cures.

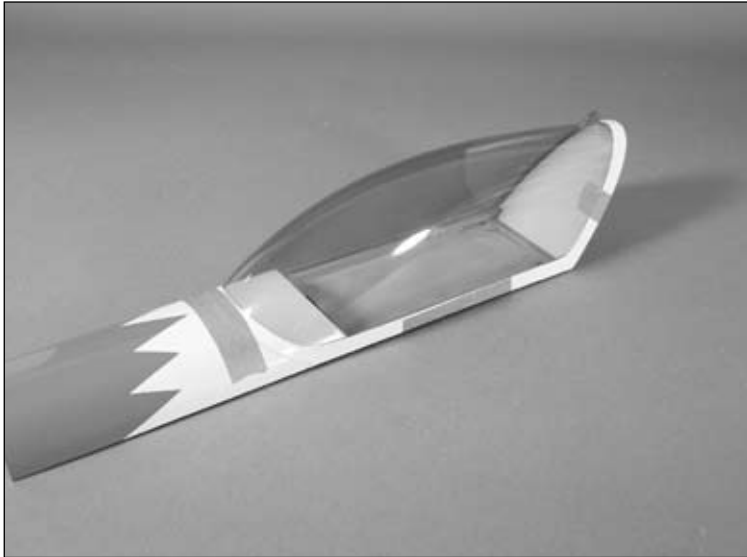

- 4. Attach the canopy hatch to the fuselage.

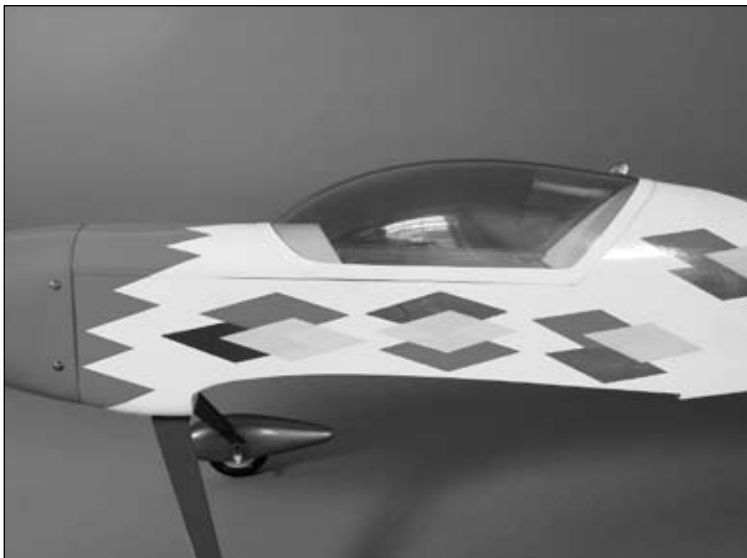

## Control Throws

- 1. Turn on the transmitter and receiver of your aircraft. Check the movement of the rudder using the transmitter. When the stick is moved right, the rudder should also move right. Reverse the direction of the servo at the transmitter if necessary.
- 2. Check the movement of the elevator with the radio system. Moving the elevator stick down will make the airplane elevator move up.
- 3. Use a throw gauge to adjust the throw of the elevator, ailerons and rudder. Adjust the position of the pushrod at the control horn to achieve the following measurements when moving the sticks to their endpoints.

### Ailerons

- High Rate: 2 in (51mm) (25°) up  
1<sup>3</sup>/<sub>4</sub> in (44mm) (22°) down
- Low Rate: 1 in (25mm) (15°) up  
7/8 in (22mm) (14°) down

### Elevator

- High Rate: 2<sup>3</sup>/<sub>8</sub> in (60mm) (30°) up  
2<sup>3</sup>/<sub>8</sub> in (60mm) (30°) down
- Low Rate: 1<sup>1</sup>/<sub>16</sub> in (27mm) (12°) up  
1<sup>1</sup>/<sub>16</sub> in (27mm) (12°) down

### Rudder

- High Rate: 2<sup>1</sup>/<sub>4</sub> in (57mm) (32°) left  
2<sup>1</sup>/<sub>4</sub> in (57mm) (32°) right
- Low Rate: Same as High Rate

## Center of Gravity

An important part of preparing the aircraft for flight is properly balancing the model.

**Caution: Do not inadvertently skip this step!**

The recommended Center of Gravity (CG) location is  $5-5\frac{1}{2}$  in (127–140mm) behind the leading edge of the wing against the fuselage.

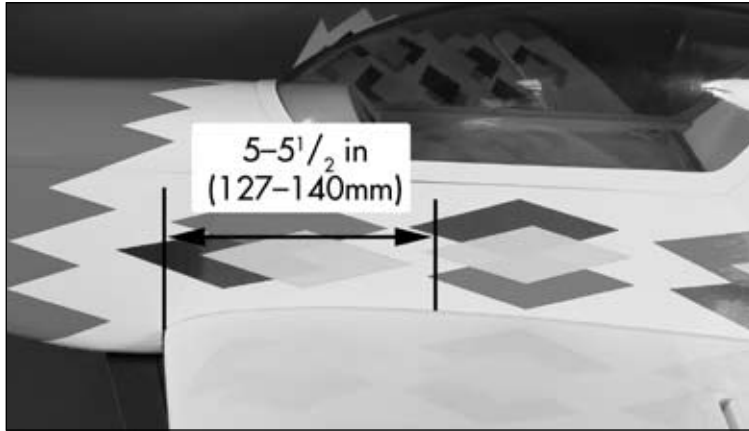

## Range Test Your Radio

- 1. Before each flying session, be sure to range check your radio. This is accomplished by turning on your transmitter with the antenna collapsed. Turn on the receiver in your airplane. With your airplane on the ground and the engine running, you should be able to walk 30 paces (approximately 100 feet) away from your airplane and still have complete control of all functions.  
If not, don't attempt to fly! Have your radio equipment checked out by the manufacturer.
- 2. Double-check that all controls (aileron, elevator, rudder and throttle) move in the correct direction.
- 3. Be sure that your transmitter batteries are fully charged, per the instructions included with your radio.

## Preflight

### Check Your Radio

Before going to the field, be sure that your batteries are fully charged per the instructions included with your radio. Charge both the transmitter and receiver pack for your airplane. Use the recommended charger supplied with your particular radio system, following the instructions provided with the radio. In most cases, the radio should be charged the night before going out flying.

Before each flying session, be sure to range check your radio. See your radio manual for the recommended range and instructions for your radio system. Each radio manufacturer specifies different procedures for their radio systems. Next, start the motor. With the model securely anchored, check the range again. The range test should not be significantly affected. If it is, don't attempt to fly! Have your radio equipment checked out by the manufacturer.

**Note:** Keep loose items that can get entangled in the propeller away from the prop. These include loose clothing, or other objects such as pencils and screwdrivers. Especially keep your hands away from the propeller.

Double-check that all controls (aileron, elevator, rudder and throttle) move in the correct direction.

Check the radio installation and make sure all the control surfaces are moving correctly (i.e. the correct direction and with the recommended throws). Test run the motor and make sure it transitions smoothly from off to full throttle and back. Also ensure the engine is installed according to the manufacturer's instructions, and it will operate consistently.

Check all the control horns, servo horns, and clevises to make sure they are secure and in good condition. Replace any items that would be considered questionable. Failure of any of these components in flight would mean the loss of your aircraft.

## Flying the Diamante 25e

---

You will find the Diamante 25e to be a solid, honest-flying model. It is capable of handling all kinds of weather.

Ensure your CG is set according to the manual and power up the aircraft. Move your throttle trim up slowly until the motor just begins to spin. This will be your flight idle that will help to establish a longer glide path and tends to make landings easier. Before taxiing out to the runway, double-check all controls are working in the correct direction and functioning properly. Taxi out to the runway and line up into the wind. You will find the rudder very effective; on the ground tracking is very predictable. Apply power smoothly and begin the takeoff roll. Correct with rudder as necessary and apply up elevator slowly until the model lifts off. Once in the air, trim the model for level flight. For optimum aerobatic performance, trim for a slight dive, both upright and inverted. Center of Gravity will affect the feel of the natural feel of this model and is why a large battery tray was designed into the aircraft to allow variations of the Center of Gravity simply by relocating the battery. Each pilot will have a personal preference of their optimum Center of Gravity, but for first flights we would recommend using the forward recommendation. Included in this kit was an aerobatic trimming article written by 7-time TOC competitor Peter Goldsmith. By following his detailed trimming information you can have the Diamante performing perfect aerobatic maneuvers.

Landing the Diamante 25e is as easy as setting up on final approach, lowering the throttle to idle and gliding in to a soft three-point touch-down. One thing to be aware of is the Diamante has a very efficient airfoil, so set up for the final glide path farther out than expected to ensure you are not overshooting the touch-down point.

We hope you enjoy the experience of flying a pure aerobatic performer like the Diamante 25e.

Happy landings.

## Reduce Your Workload

---

One of my passions in life is to teach. After a long discussion with Mike Hurley and after sharing with him how passionate I was to share my life's aerobatic knowledge, we decided that a trimming article would be a great start. A properly trimmed model can reduce your workload in an aerobatic sequence by an enormous amount. I judged at the nationals this year and thoroughly enjoyed the experience. I was also impressed with the skills, especially in the lower classes, when displayed by pilots trying to fly with a poor trim setup. I was truly amazed how tolerant people were; in fact, it drove me crazy to watch. I remember bouncing out of my judging chair and saying to Mike, "Boy, I need to help these people." Hence, here I am typing away at my exciting pace of about 80 minutes per word <grin> in an attempt to help educate the great skill base that exists in the US scale aerobatic scene. Like all good input, it doesn't come from me, but is more a summary of 25 years of meeting people who shared their thoughts on trimming with me, then melting them down into some kind of legible format that most can understand.

## Servo and Control Setup

---

3D and precision model trim typically go against each other. What I mean by this is that when pilots set up their new 40% something, they go straight for the big rates—35, 40, and sometimes up to 50 degrees of throw. Any thoughts about how this can affect the servo resolution, and more importantly the servo power? 99% of scale aerobatic events allow a separate aircraft for freestyle. Between 80–100% of the results at a scale aerobatic event comes from the precision elements, known and unknown sequences, of the event. Please don't misunderstand me, I love to watch freestyle flying, and admire the talent of the pilots that do it well; it's innovative and has been one of the main contributors to the growth of giant-scale aerobatic aircraft. My point is: why not have your free setup, specifically for the free event, then have a precision setup for known and unknown sequences. I know for me personally, having a model just for freestyle will be something I aim to do in the future. Having said that, a good alternative is to have a more biased precision control setup, which will no doubt improve your precision flying, especially if you're a regular attendee to the scale aerobatic event. With my Cap, I use 1" horns on all surfaces with the exception of Rudder which uses 1 ¼". I have 28 degrees on aileron, 32 degrees on elevator and 35 degrees on rudder. For me, this is a good compromise for precision and free flying, "with the bias towards Free". With 1" horns, and 1 ½" distance from control hook up, I am getting slightly better than 1-to-1 ratio. More importantly I am getting closer to the maximum servo power and control geometry available. With 1" horns, my resolution is better, control slop is reduced, and servo wear is greatly improved. Another novel bonus is that I don't need as many servos per surface. Give it a try next time you set up your aircraft, you may be surprised, in fact in some cases you may see no difference in control responsiveness by going to 1" horns, as with the better geometry you may be reducing your control blow back. One of the biggest challenges I see pilots dealing with is surface blow back. With blow back, your snap exits will be all over the place, both entry and exits. Getting consistent flying is almost impossible.

Every time your speed changes, your control response will change. Hmmn, I suspect a few lights just went on. Yep, could it be the fact that you consistently miss your snap exits is not due to your skills, but control blow back.

When setting up your servos, make sure you run the numbers, do the math and figure out just how much power you are delivering to the surface. All servos are rated at inch ounces, that is at one inch from the center of the servo. An 8611 is 266 oz/in at 6V. With a 2" horn they are only 133, and around 200 with a 1 ½" horn. Years ago I was able to measure the forces on my Cap, believe it or not the ailerons required well over 30 pounds of force to deflect at 100 mph. Now there are a lot bigger ailerons out there than mine. Please pay attention to this; it is crucial to consistent flying. If you have to use 1 ½" horns, or 2" horns, you will need more servos.

## Sequencing

---

Many of the trimming articles I have seen over the years incorporate some kind of chart or graph saying do this and this happens and so on. My concept of sequencing your trimming is simple. If you get your trimming out of sequence you will end up chasing your tail. As with most things in this universe, for every cause there is an effect, and the same applies to trimming a model aircraft. So many times I see people test flying there now aerobatic creation, flip the thing on its side and see what kind of knife-edge mixing it may need. Thrust, Center of Gravity, wing balancing and basic flight control trim can all affect knife tracking.

I can't make this point more loud and clear—it is very important to trim your model in the correct sequence to make sure each adjustment has no effect on the previous adjustment.

You will see I have broken each element down, and there is an intentional order in which I recommend to trim a model. Model balance, Center of Gravity is number 1, differential, knife edge flight, down line tracking will all be affected by the Center of Gravity. Next is dynamic balancing, known as “wing tip weight.” Then comes thrust angles, aileron differential, and finally programmable mixing, knife-edge tracking, roll coupling, down line track. Finally if you change your propeller, your whole trim setup will change.

## Balance

---

OK, how do I know what is the correct CG for my model. If in doubt, read the instructions. Yep, chances are somebody from the TOC or similar has designed your aircraft and has determined over many flights, where the Center of Gravity should be. For precision flying forward is better, but... too far forward can be a problem. I cannot put in writing what is the best feel for each pilot, other than it is a feel thing. I can, however, give you some symptoms of too far back and too far forward, plus some simple tests I do to check.

One of my favorite ways to determine the correct Center of Gravity is spin entries. For precision flying I would expect you to be running between 12–15 degrees of elevator throw. If you feel you need more than this, check your exponential—it may be too high. Just as a starting point, 35% expo is what I call a linear feel. What I like to have with my expo is when at half stick, I get about 50% of the reaction of full stick, around 35–40% expo gives you this with modest control deflections. Ok, if that didn't make sense: If I have my stick at full travel, my aircraft will roll around 360–400 degrees per second, about right for precision. Now when I only move my stick halfway, I should be looking for 180–200 degrees per second. Make sense?

If when entering a spin, your model mushes, kind of slides into the spin with no real stall visible, you may be too far forward. Another sign of forward is excessive down elevator needed for inverted flight. This is not always the reason but is a sign. Rear Center of Gravity is probably easier to see for most pilots. Model is sensitive in pitch, unpredictable around the stall, climbs when on an inverted 45 degree line are some I have noticed. Center of Gravity is mainly about feel, each person will have their preferences, each aircraft will have its preferences. Be patient, spend some time on this one, it's important you are happy with your Center of Gravity. I would recommend at least 10–15 flights before making the commitment to where it needs to be if it's a new model.



## Dynamic Balance

---

Ok, we are happy with our Center of Gravity, so the next thing is dynamic balance. This is really only relevant with wing tip weight, most other axes on a model aircraft are not affected too much by the dynamic effects of high G force loads. Having said that, your wings are. Just because they both weigh the same, and don't carry any aileron trim doesn't mean you can't have a wing weight problem. I have seen a myriad of ways to test for wing weight trim—loops, pulling to vertical, and so on. My suggestion is to think about the sequencing argument. If you do loops, or pull to a vertical up line, the engine thrust can have an effect, yet we haven't got to trim our thrust angles yet. Think about it, what could you do to check your wing tip weight in flight that will not be affected by thrust. What I do is put the model into a vertical dive (minimum of 3–4 seconds) and pull a hard corner at the bottom. No matter where your wings are in roll, when you pull to level, the wings must be level. Check this concept with your stick plane. It really doesn't matter where your wings are, as you pull to horizontal flight your wings must be level. If you attempt to pull a hard vertical from horizontal, you must be absolutely sure your wings are perfectly level. I don't know about you guys, but I am not that good. If you go from vertical to horizontal, not only will the engine thrust have no effect but your wings can be anywhere as you are on a vertical down line. Now when you pull the corner, the aircraft may be pointing in a different direction than you planned, but that is ok, as long as the wings are level. When I was told this wing weight checking procedure years ago, it made so much sense. The only thing I would recommend you pay attention to is making sure you only use elevator through the corner. Don't be quick to make a decision. Have a friend observe the proceedings, do many pull outs, and make absolutely sure before you move on to the next step of trimming.

## Thrust Angles

---

OK, guys, it's time to put aside aesthetics and get that thrust correct. I sure see a lot of spinners perfectly lining up these days. One of the biggest deterrents to adjusting for the correct thrust angles is the spinner won't line up anymore. That's true. Once again, when building your model, pay attention to the instructions, chances are somebody has figured it out pretty close. What I like to do, or used to do, is test fly the model before I paint the cowl. Once I am happy with thrust, I can make the appropriate cosmetic changes to complete the model before painting. Setting up the correct thrust angles is fairly simple. Well, it's simple to identify, harder to adjust.

Right thrust. Now we know our wing tip weight is correct, we should be able to confidently perform some accurate vertical up lines. Number one issue with this is making sure your wings are level. Don't guess, be absolutely sure your wings are level before pulling to a vertical. I have seen people add unnecessary right thrust as they were not level when pulling corners, leaving an inside wing down (normal human behavior) and the model would lean to the left. What I like to do is to fly directly overhead, into the wind, where I can clearly see my wings, then pull to a vertical up line. Ok, up we go, first 100' is good, next hundred feet is good, moving through 500', still tracking well, up over 1000' now, still straight, coming up on 10,000, arrrrrh, I see it drifting to the left a little. Ok, Ok, I am being sarcastic, but I hope you see my point. Most vertical up lines in patterns I have flown never exceed 1000', well some do but it's rare. You will never get your thrust perfect up to 10,000 feet. If you're working at it, best you can hope for is around 1000 or so feet. Speed will have a huge effect of your thrust angle on a vertical up line. Entry speed, compared to under load after climbing to 100' will be as much as 30–40mph slower. Now a great little tip I learned for making the adjustments.

After many pull ups, you really need more right thrust, as you pass through 500' you can clearly see your model drifting to the left. Here is the cool tip: apply some right rudder and continue to apply it until it tracks straight. Bring the plan into land and check your rudder deflection. Use a protractor to see how many degrees of rudder you required for a straight vertical. Whatever it is, divide it by 2 and that will be what you need to add to your right thrust. If you have 2 degrees of right rudder, you will need to add 1 deg more of right thrust. It works, it really does, and it works both ways. If you need left rudder (too much right thrust) you can use the same equation.

## Differential

---

Aileron differential is one of the most important aspects of model trim. With the multiple point rolls on both up and down lines in today's modern patterns, poor differential can be a real headache. The good news is it's pretty easy to detect and adjust for axial rolls. The important thing at this stage of the game is knowing our thrust, and wing weight is correct, then we can proceed with our differential setups. You're probably starting to understand the importance of trimming your model, in the correct sequence. Each step complements the last and should have no negative effects in trim.

Aileron differential is required when the drag of the down going aileron does not match the up going aileron. No, I am definitely not George Hicks, and to be truthful it scares me that George will read this and realize how simple I think. Before we go further, I would like to interject here, that you make absolutely sure you are not getting surface blow back. You will never get your differential correct if you are. It's easy to check for. Push to a vertical down line and roll to the right, stop rolling for a second, then roll again. The roll rate should be the same. If it is slowing, then your surfaces are not reaching their intended throws. Another sign is your up line roll rate is faster than your down. Please, you need to fix this. Do what needs to be done. Either increase your servo power, or improve your geometry, by reducing the servo horn radius, and/or increasing the distance the control horn pickup is from the hinge line, or if you have lots of cash, add more servos. Whatever path you take, you can't afford to have surface blow back as your flying will never be consistent. Most modern radios have a differential program. I have used both the ATV function or the Differential function and both work well.

I want you to use the same technique as before when checking for the thrust, only this time only pull to 45 degrees, making sure you are either directly into the wind, or directly down wind. Using full aileron deflection, roll to the right. If the aircraft (what I call )walks to the right, then you have too much down travel on your ailerons. If you roll to the right and the model “walks” to the left, you have too much up travel in your ailerons. Repeat this process to the left as well until you are satisfied your model is tracking true in the roll axis. Like with the thrust angles, don’t expect your model to continue to roll for 5000’ on a string—it just can’t be done. As per previous recommendations, go for the majority situation. With the correct differential on your model, you will be amazed how easy it is to do hesitations on lines.

## Programmable Mixing

---

You will notice this subject is the last in the sequence but for many, it’s the first—many people go straight to this section first. My model has 5% mix on rudder. I get phone calls all the time from excited pilots. Pete, I just test flew my New Edge; it only has 8% Aileron mix and 4% knife-edge mixing. Boy I think, they sure got to the details of trimming their model faster than I can. The point I like to make throughout this article is to stick to the correct sequence. Know that only after perhaps 10–15, perhaps 20 flights, are we going to work on the mixing to fine tune our model.

What I would like to do is to break up this Programmable Mix section into 2 sections. The first is the down line, torque offset or throttle offset mixing and second, the traditional rudder elevator/aileron mixing. Most people have a fairly good understanding of the latter, ruder to elev/aileron but not many are using Throttle offset mixing. Some I have seen, but only in the pitch compensation. What I would hope you all pay attention to is what your model is doing on a down line, or at reduced throttle (Idle) in the roll or Yaw axis. It’s both these areas I see people struggle. One of the benefits of judging our events is you see a lot of strange trim situations. Remembering back at the Nationals, I can clearly remember models rolling on down lines, and yawing off axis causing some strange-looking down line rolls. It’s almost impossible to have perfect trim in roll at all speeds. All you can hope for is to mix out some compensation to help reduce your workload. Both the Yaw and Roll axis, in most cases have a bigger affect in your model track on down lines than any other situation. Imagine what the effects of a 5 degree error on every down line would mean. Over the length of the box (Yes, I think we need a box to fly in) you can drift in or out by as much as 150’ and the same applies to the yaw axis. Ever noticed how hard it is to get your wings level when approaching a pull corner with little time. With your model rolling and yawing at different speeds, you will never be consistent. It is hard enough to be absolutely sure that your wings are level, let alone chase an out-of-trim situation.

Good news is, it's fairly easy to compensate for. Lets do the roll axis first, you can do this 2 ways and both work well. In fact, I would suggest you try both to get the best input.

Version 1 is to climb to a high altitude, simulating a typical top of the box altitude and fly directly over your head and into the wind. About 50–100 feet out from your self, push down.

You are now looking at the plan view of the model. Watch carefully to see if the model is rolling on the down line. Most models will roll slightly to the right. Personally, I have never had a model that hasn't needed a little left aileron mix on low throttle. I'm not saying it can't happen but I personally haven't seen it. The second way to check for throttle Aileron mix is to fly along at level flight, medium height and reduce the throttle. Watch carefully and see if your model is rolling, chances are it will. Arrr, ever wondered why you always have to lean a little left aileron entering spins, or why your model always falls one way, perhaps it's because your low power trim is not correct.

Ok, the second Programmable Mix is the throttle-to-rudder mix. Same deal, it's hard to get your model to track correctly in the yaw axis at all speeds, your only hope is to apply a small amount of "left" rudder on low throttle. To check for this, use the same technique as the throttle-to-aileron: fly above yourself, directly into the wind and push down in front of yourself and watch carefully. You will be amazed, especially at the start of the down line. If you haven't got any throttle offset to rudder, you are most likely flying around the problem, and where I find it most challenging is in figure 9's and vertical and horizontal 8's. Any time you are using elevator and are off on the yaw axis, it's a bad hair day. I can hear all you guys thinking, yes it's true. Your model perhaps could need a little rudder mix on low throttle. Give it a try, you will be amazed. I know of some fairly experienced modelers that use the same theory but reverse where the mix is. They use little to no right thrust on the engine but have right rudder mixed on full throttle. That works well, or so I've been told, but I haven't tried it myself. One thing you may want to experiment with in both these scenarios is where the mix is activated. I like to have the stick offset at

least above half and let it progress from there. It seems to be the best balance, plus I am not getting a sudden mix input; it progresses more or less with the speed of the model. This will vary from model to model but try to keep the mix activation well above an idle setting.

Hopefully you have noticed when working through the trim sequence how each trim adjustment has complemented the next stage. Rudder Aileron Mix. In most cases only requires a linear Programmable Mix. What I mean by linear Programmable Mix is that you don't need a progressive value to the mix. (i.e Less at the start, more at the end and the mix will be linear.) Most modern designs, with the exception of Bi-planes, are real close and only require a small amount of Rudder Aileron Mix. It's fairly easy to identify. Some like to put their model on knife-edge, but I like to just do flat turns, simulating rolling turn inputs. Remember, play the numbers, rolling turns require more precise mixing than sustained knife-edge flight. In fact, you don't do much flying on your side at all, but you sure do a lot of rolling turns. So, I like to do the flat turn thing. Doing a simple inside rudder turn to the left, using left rudder, the model should just yaw, with no roll effect. If the plane rolls to the left, then you need to mix 2–5% right aileron to left rudder. My Cap is a little unique as it has adverse roll. When I apply left rudder, the model rolls right, so I need left aileron mixed with left rudder. Repeat the process with right rudder. Now what I want you to do is vary the speed in which you do your flat turns. If you find as you increase your speed the mix becomes too much, you could be getting surface blow back. Man, sorry to keep harping about this but it is important. With insufficient rudder power, when you apply a Programmable Mix for roll, or pitch for that matter, the mix will become too much value as the rudder throw reduces due to aerodynamic pressure. I see a few lights going off again. Could this be why you have your mix perfect for knife edge, but you chase your aircraft all over doing rolling circles?

Rudder elevator. I think about 3 times in my entire life I had a model that didn't need rudder elevator compensation. Same as with the previous rudder aileron, start by doing a flat turn to the left and see what happens. If your model pitches down when rudder is applied, then mix a small amount of up elevator: if it pitches up, apply a small amount of down elevator. There are some cases, even without blowback, the mix value will not be exactly correct for all throttle settings.

Don't panic, as with most modern radios suitable for Aerobatics, you can use what is called a curve mix. This mix allows you to have multiple points along your mix curve to increase or decrease your mix value at different rudder inputs. My Cap is a good example of this. At low rudder throws, I only need 1–2% mix, but as the throw increases, I need up to 10%. If I just have a 10% mix it will be too much at small rudder inputs. The curve mix is designed to solve this problem.

One of the most common questions I get asked is what can I do to improve my aerobatic performance. My answer is unique but I hope you will at least consider the next few comments. My advice is not to let the ego take over your goals; practice hard and focus on the fact there will always be somebody better than you—from my experience there always was. This may seem a little harsh, but in all my years of flying aerobatics, and not to exclude myself in this comment, egos and over-confidence can be the biggest hindrance in a pilot's ability to grow. Try to avoid letting your ego be your only motivation. Be objective, be humble, listen, watch and experiment, that's what all the TOC and Masters pilots do. Sure, we all have egos, but at some stage of our lives our egos have let us down. We were humbled and forced to listen and be objective.

That's about it, stay cool and hopefully we can catch up at the next aerobatic event.

Pete

# 2007 Official AMA National Model Aircraft Safety Code

## GENERAL

- 1) I will not fly my model aircraft in sanctioned events, air shows or model flying demonstrations until it has been proven to be airworthy by having been previously, successfully flight tested.
- 2) I will not fly my model higher than approximately 400 feet within 3 miles of an airport without notifying the airport operator. I will give right-of-way and avoid flying in the proximity of full-scale aircraft. Where necessary, an observer shall be utilized to supervise flying to avoid having models fly in the proximity of full-scale aircraft.
- 3) Where established, I will abide by the safety rules for the flying site I use, and I will not willfully or deliberately fly my models in a careless, reckless and/or dangerous manner.
- 4) The maximum takeoff weight of a model is 55 pounds, except models flown under Experimental Aircraft rules.
- 5) I will not fly my model unless it is identified with my name and address or AMA number on or in the model. (This does not apply to models while being flown indoors.)
- 6) I will not operate models with metal-bladed propellers or with gaseous boosts, in which gases other than air enter their internal combustion engine(s); nor will I operate models with extremely hazardous fuels such as those containing tetranitromethane or hydrazine.

## RADIO CONTROL

- 1) I will have completed a successful radio equipment ground range check before the first flight of a new or repaired model.
- 2) I will not fly my model aircraft in the presence of spectators until I become a qualified flier, unless assisted by an experienced helper.
- 3) At all flying sites a straight or curved line(s) must be established in front of which all flying takes place with the

other side for spectators. Only personnel involved with flying the aircraft are allowed at or in front of the flight line. Intentional flying behind the flight line is prohibited.

- 4) I will operate my model using only radio control frequencies currently allowed by the Federal Communications Commission. (Only properly licensed Amateurs are authorized to operate equipment on Amateur Band frequencies.)
- 5) Flying sites separated by three miles or more are considered safe from site-to-site interference, even when both sites use the same frequencies. Any circumstances under three miles separation require a frequency management arrangement, which may be either an allocation of specific frequencies for each site or testing to determine that freedom from interference exists. Allocation plans or interference test reports shall be signed by the parties involved and provided to AMA Headquarters.

Documents of agreement and reports may exist between (1) two or more AMA Chartered Clubs, (2) AMA clubs and individual AMA members not associated with AMA Clubs, or (3) two or more individual AMA members.

- 6) For Combat, distance between combat engagement line and spectator line will be 500 feet per cubic inch of engine displacement. (Example: .40 engine = 200 feet.); electric motors will be based on equivalent combustion engine size. Additional safety requirements will be per the RC Combat section of the current Competition Regulations.
- 7) At air shows or model flying demonstrations, a single straight line must be established, one side of which is for flying, with the other side for spectators.
- 8) With the exception of events flown under AMA Competition rules, after launch, except for pilots or helpers being used, no powered model may be flown closer than 25 feet to any person.
- 9) Under no circumstances may a pilot or other person touch a powered model in flight.





© 2007 Horizon Hobby, Inc.  
4105 Fieldstone Road  
Champaign, Illinois 61822  
(877) 504-0233  
[horizonhobby.com](http://horizonhobby.com)  
[E-fliteRC.com](http://E-fliteRC.com)