

# Advance 25e ARF

Assembly Manual



## Notice

All instructions, warranties and other collateral documents are subject to change at the sole discretion of Horizon Hobby, Inc. For up-to-date product literature, visit <http://www.horizonhobby.com> and click on the support tab for this product.

## Meaning of Special Language

The following terms are used throughout the product literature to indicate various levels of potential harm when operating this product:

**NOTICE:** Procedures, which if not properly followed, create a possibility of physical property damage AND a little or no possibility of injury.

**CAUTION:** Procedures, which if not properly followed, create the probability of physical property damage AND a possibility of serious injury.

**WARNING:** Procedures, which if not properly followed, create the probability of property damage, collateral damage, and serious injury OR create a high probability of superficial injury.

 **WARNING:** Read the ENTIRE instruction manual to become familiar with the features of the product before operating. Failure to operate the product correctly can result in damage to the product, personal property and cause serious injury.

This is a sophisticated hobby product and NOT a toy. It must be operated with caution and common sense and requires some basic mechanical ability. Failure to operate this Product in a safe and responsible manner could result in injury or damage to the product or other property. This product is not intended for use by children without direct adult supervision. Do not attempt disassembly, use with incompatible components or augment product in any way without the approval of Horizon Hobby, Inc. This manual contains instructions for safety, operation and maintenance. It is essential to read and follow all the instructions and warnings in the manual, prior to assembly, setup or use, in order to operate correctly and avoid damage or serious injury.

## Warnings

Read and follow all instructions and safety precautions before use. Improper use can result in fire, serious injury and damage to property.

Age Recommendation: Not for children under 14 years. This is not a toy.

## COMPONENTS

Use only with compatible components. Should any compatibility questions exist please refer to the product instructions, the component instructions or contact Horizon Hobby, Inc.

## FLIGHT

Fly only in open areas to ensure safety. It is recommended flying be done at AMA (Academy of Model Aeronautics) approved flying sites. Consult local laws and ordinances before choosing a location to fly your aircraft.

## PROPELLER

Keep loose items that can get entangled in the propeller away from the prop, including loose clothing, or other objects such as pencils and screwdrivers. Especially keep your hands away from the propeller as injury can occur.

## BATTERIES



### Notes on Lithium Polymer Batteries

When misused, lithium polymer batteries are significantly more volatile than alkaline or Ni-Cd/Ni-MH batteries used in RC applications. Always follow the manufacturer's instructions when using and disposing of any batteries. Mishandling of Li-Po batteries can result in fire causing serious injury and damage.

## SMALL PARTS

This kit includes small parts and should not be left unattended near children as choking and serious injury could result.

## SAFETY PRECAUTIONS

- Check all control surfaces prior to each takeoff.
- Do not fly your model near spectators, parking areas or any other area that could result in injury to people or damage of property.
- Do not fly during adverse weather conditions. Poor visibility can cause disorientation and loss of control of your aircraft. Strong winds can cause similar problems.
- Do not take chances. If at any time during flight you observe any erratic or abnormal operation, land immediately and do not resume flight until the cause of the problem has been ascertained and corrected. Safety can never be taken lightly.
- Do not fly near power lines.

## Table of Contents

Notice .....	2
Meaning of Special Language .....	2
Warnings .....	2
Introduction .....	3
Important Information Regarding Warranty Information .....	3
Specifications .....	3
Using the Manual .....	3
Contents of Kit/Parts Layout .....	3
Covering Colors .....	3
Hardware/Accessory Sizes .....	3
Recommended Radio Equipment .....	4
Power 25 Motor Setup .....	4
Power 32 Motor Setup .....	4
Optional Accessories .....	4
Required Tools and Adhesives .....	4
Hinging the Ailerons .....	4
Aileron Servo Installation .....	6
Joining the Wing Panels .....	9
Radio Installation .....	11
Nose Gear Installation .....	13
Motor Installation .....	15
Main Landing Gear Installation .....	18
Wing Installation .....	20
Stabilizer and Vertical Fin Installation .....	21
Hinging the Elevator and Rudder .....	24
Rudder and Elevator Linkage Installation .....	25
Optional Pilot Installation .....	27
Canopy Installation .....	28
Canopy Installation .....	29
Decal Installation .....	29
Center of Gravity .....	30
Control Throws .....	30
Preflight .....	31
Flying Your Advance 25e ARF .....	31
Range Test Your Radio .....	32
Daily Flight Checks .....	32
Warranty and Repair Policy .....	32
Warranty Services .....	33
Compliance Information for the European Union .....	34
2010 Official Academy of Model Aeronautics Safety Code .....	34

## Introduction

E-flite® is proud to announce the Advance 25e, a low-wing sport plane with exceptionally smooth flight performance at an accessible price. Designed by world-class competition pilot and designer, Mike McConville, this aircraft includes semi-symmetrical airfoil wings for great aerobatic flight, tricycle landing gear for excellent ground handling, and an UltraCote® trim scheme to provide the best finish. Additionally, convenience plays a big factor in the Advance 25e, which is why it is designed for both 25 and 32-size brushless outrunner motors and is constructed with a bolt-on wing for simpler setup and tear-down for easy transport.

### Important Information Regarding Warranty Information

Please read our Warranty and Liability Limitations section before building this product. If you as the Purchaser or user are not prepared to accept the liability associated with the use of this Product, you are advised to return this Product immediately in new and unused condition to the place of purchase.

### Specifications

Wingspan:	52.5 in (1335mm)
Wing Area:	535 sq in (34.5 sq dm)
Length:	49.0 in (1245mm)
Weight w/o Battery:	3.70–3.90 lb (1.6–1.8 kg)
Weight with Battery:	4.40–4.06 lb (1.9–2.1 kg)

## Using the Manual

This manual is divided into sections to help make assembly easier to understand, and to provide breaks between each major section. In addition, check boxes have been placed next to each step to keep track of its completion. Steps with a single circle (○) are performed once, while steps with two or more circles (○○) indicate the step will require repeating, such as for a right or left wing panel, two servos, etc.

Remember to take your time and follow the directions.

### Contents of Kit/Parts Layout

#### Replacement Parts

EFL422501	Wing Set with Ailerons
EFL422502	Fuselage with Hatch
EFL422503	Tail Set
EFL422504	Pushrod Set
EFL422505	Landing Gear Set
EFL422506	Canopy
EFL422507	Decal Set
EFL422508	Wood Spacer, Power 32
EFL422509	Wheels Set



### Covering Colors

White	HANU870
True Red	HANU866
Deep Blue	HANU873

### Hardware/Accessory Sizes

Main wheel diameter	2 <sup>1</sup> / <sub>4</sub> -in (57mm)
Nose wheel diameter	2-in (51mm)

## Recommended Radio Equipment

You will need a minimum 4-channel transmitter, receiver and six servos. You can choose to purchase a complete radio system. If you are using an existing transmitter, just purchase the other required equipment separately. We recommend the crystal-free, interference-free Spektrum™ DX6 2.4GHz DSM® 6-channel system. If using your own transmitter, we recommend the following radio equipment.

If you own the Spektrum DX6i radio, or you are using a different DSM2 radio, just add the AR6200 DSM2™ 6-channel receiver and four JR SPORT™ MN48 servos.

### Complete Radio System

SPM6600 DX6i DSM2 6CH system

### Or Purchase Separately

SPMAR6200 AR6200 DSM2 6-Channel Full-Range Receiver  
JSP20040 MN48 Servo (4)  
JRPA135 Y-harness ailerons to receiver  
JSP98100 3-inch (76mm) Servo Extension

## Power 25 Motor Setup

EFLM4025A Power 25 BL Outrunner Motor, 870Kv  
EFLA1040L 40-Amp Lite Pro SB Brushless ESC  
EFLB32003S30 3200mAh 3S 14.8V 30C Li-Po, 12AWG EC3  
APC12080E 12 x 8E Electric Propeller

## Power 32 Motor Setup

EFLM4032A Power 32 Brushless Outrunner Motor, 770Kv  
EFLA1060 60-Amp Pro Switch-Mode BEC Brushless ESC  
EFLB32004S30 3200mAh 4S 14.8V 30C Li-Po, 12AWG EC3  
APC12060E 12 x 6E Electric Propeller

## Optional Accessories

EFLSP175 1<sup>3</sup>/<sub>4</sub>-inch Aluminum Spinner with 4mm and 5mm Collets  
EFLA110 Power Meter  
EFLC505 Intelligent 1- to 5-Cell Balancing Charger  
EFLAEC312 Charge Lead with 12-inch Wire and Jacks, 16AWG  
EFLA151 1/9 Civilian Pilot, Blue

## Required Tools and Adhesives

### Tools & Equipment

Drill Epoxy brush  
Felt-tipped pen Flat file  
Low-tack tape Mixing cup  
Mixing stick Medium grit sandpaper  
Paper towel Pencil  
Pin vise Phillips screwdriver: #1, #2  
Pliers Rubbing alcohol  
Ruler Scissors  
Side cutter Spinner  
Square T-pins  
Drill bit: 1/16-inch (1.5mm), 5/64-inch (2mm)  
Hex wrench: 2.5mm, 3/32-inch  
Hobby knife with #11 blade

### Optional Tools & Equipment

Balancing stand (optional)  
Box wrench: 10mm  
Z-bend pliers

### Adhesives

30-minute epoxy Silicone adhesive  
Thin CA Medium CA  
Threadlock

## E-tips

During the course of building your model we suggest you use a soft base for the building surface.

Such things as a foam stand, large piece of bedding foam or a thick bath towel will work well and help protect the model from damage during assembly. This is not shown in the instructions to provide the greatest detail in the photos.

## Hinging the Ailerons

### Required Parts

Wing panel with aileron (left and right)

### Required Tools and Adhesives

Thin CA T-pins  
Pin vise Drill bit: 1/16-inch (1.5mm)

- 1. Locate the wing panel. Separate the aileron from the wing panel. Set the four hinges aside at this time.

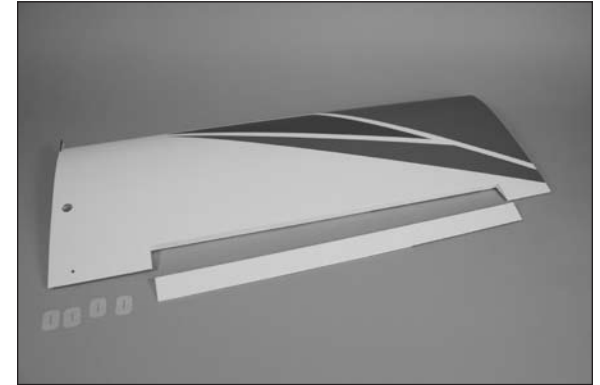

- 2. Use a pin vise and 1/16-inch (1.5mm) drill bit to drill a hole in the center of each hinge slot in the wing panel. This will provide a tunnel for the CA to wick into, making the bond between the hinge and wood stronger.



- 3. Prepare the aileron for hinging following the procedure described in Step 2.



- 4. Slide the hinges into the aileron. Insert the hinges so the holes in the hinge are at the hinge line. Insert a T-pin through one of the holes to keep the hinge centered when the aileron is installed on the wing panel.

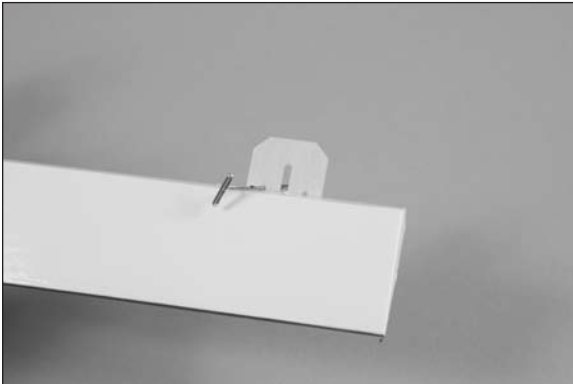

- 5. Slide the hinges in the aileron into the slots on the wing. Check that the gap at each end of the aileron is equal.

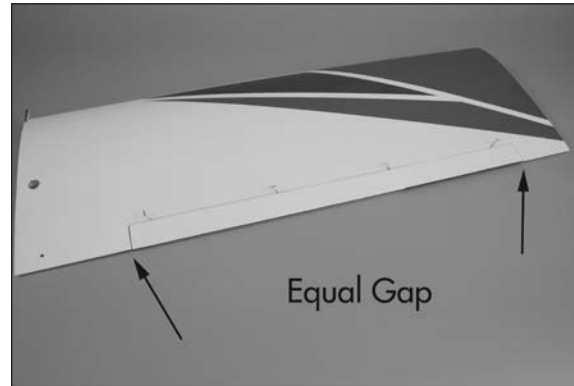

***E-tips***

When gluing the hinges, do not use a CA accelerator. The CA must be allowed time to soak into the hinges to provide the best bond between the hinge and surrounding wood.

- 6. Remove the T-pins from the hinges. Make sure the aileron is tight against the wing. Wick thin CA into each hinge, both top and bottom, until the hinge is saturated with CA. Allow the CA to fully cure before proceeding.



- 7. Once the CA has fully cured, gently pull on the wing and aileron to make sure the hinges are glued securely. If not, reapply thin CA to any hinges that are not secure.

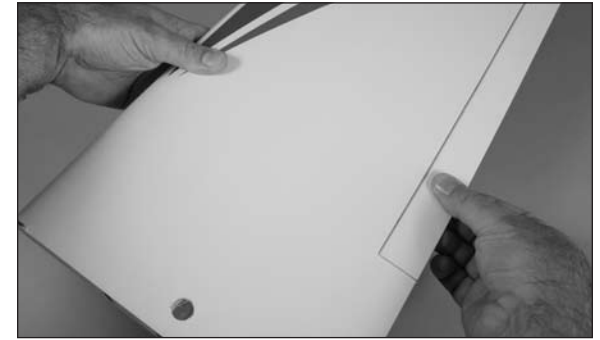

- 8. Flex the aileron through its range of motion a number of times to break in the hinges. This will reduce the initial load on the servo for your first flights.

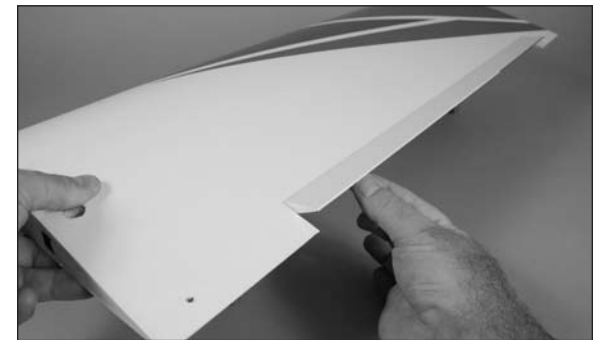

- 9. Repeat Steps 1 through 8 to install the remaining aileron and hinges.

## Aileron Servo Installation

### Required Parts

Silicone tubing      Nylon clevis (2)  
Transmitter      Receiver  
Wing panel with aileron (left and right)  
Servo with hardware (2)  
Threaded pushrod, 11<sup>7</sup>/<sub>8</sub>-inch (302mm)  
Nylon control horn with backplate (2)  
2mm x 12mm machine screw (4)

### Required Tools and Adhesives

Thin CA      Pin vise  
Side cutter      Square  
Felt-tipped pen      Hobby knife with #11 blade  
Ruler      Low-tack tape  
Pliers  
Drill bit: 5/64-inch  
Phillips screwdriver: #1

### Optional Tools

Z-bend pliers

## **Etips**

Before starting the installation of the servos, it is recommended to center the trims and sticks on your transmitter. If you are using a computer radio, make sure to reset a model memory and name it for this particular model. We also recommend binding the transmitter and receiver at this time following the instructions provided with your radio system.

- ○ 1. Prepare the aileron servo by installing the rubber grommets and brass eyelets as described in the servo instructions.

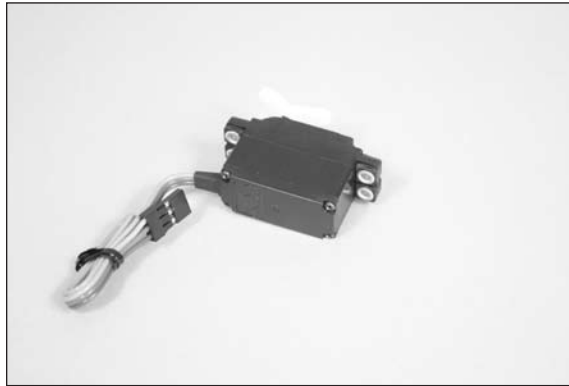

- ○ 2. Use a #1 Phillips screwdriver to thread a servo mounting screw in each of the four servo mounting holes. This will cut threads into the surrounding wood.



- ○ 3. Apply 2–3 drops of thin CA in each of the servo mounting holes. This will harden the threads in the surrounding wood, which will help prevent the screws from vibrating loose.

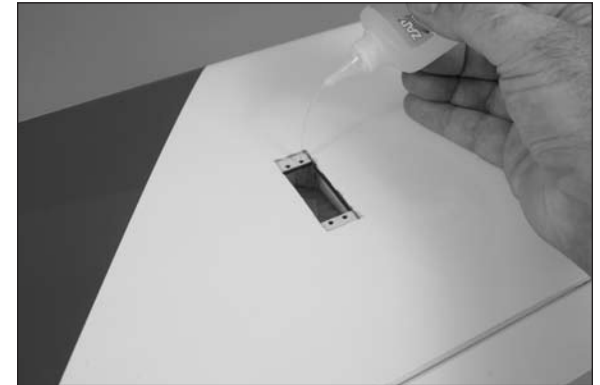

- ○ 4. Carefully remove the string from the servo pocket. Make sure not to pull the string loose from the center of the wing. Tie the end of the string around the servo lead near the connector.

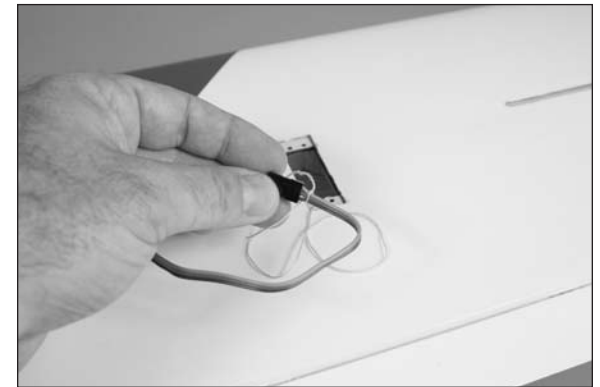

- 5. Use the string to pull the servo lead through the wing and out of the hole in the top of the wing panel.



### ***E-tips***

Leave a small amount of string tied to the servo lead. Tape the string to the top of the wing to prevent the servo lead from falling back into the wing.

- 6. Use the screws provided with the servo to secure it in the wing. The output shaft of the servo will face the aileron. Use a #1 Phillips screwdriver to tighten the servo mounting screws.



- 7. Use the radio system to center the aileron servo. Position the servo horn parallel to the hinge line of the aileron. Enlarge the hole in the servo horn facing toward the wing tip that is 1/2-inch (13mm) from the center of the horn using a pin vise and 5/64-inch drill bit. Use side cutters to remove any unused arms from the servo horn so they don't interfere with the operation of the aileron servo.

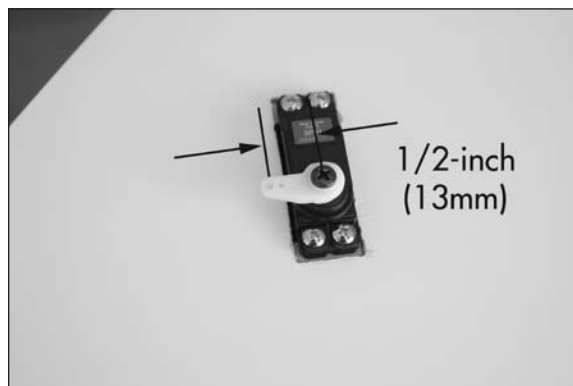

### ***E-tips***

When installing the aileron servos, the linkages must connect to the side of the servo facing the wing tips as shown.

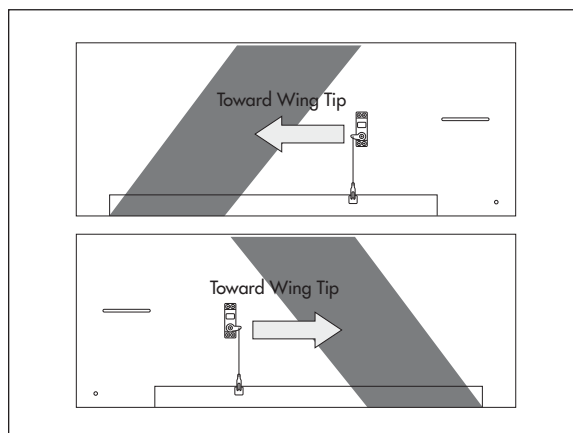

- 8. Position a square so it is aligned with the edge of the wing and the hole in the servo horn enlarged in Step 6. Use a felt-tipped pen to mark the aileron for the aileron control horn. This aligns the horn and linkage correctly for your model.

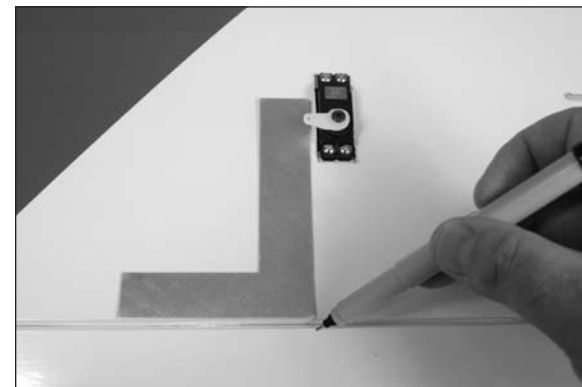

- 9. Position the control horn on the aileron. The holes in the control horn will align with the hinge line of the aileron, and with the mark made in the previous step. Use a felt-tipped pen to transfer the locations for the control horn mounting screws on the aileron.

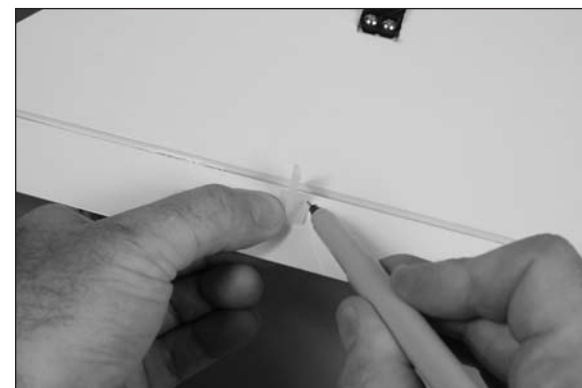

- ○ 10. Use a pin vise and 5/64-inch (2mm) drill bit to drill the two holes for the control horn mounting screws.

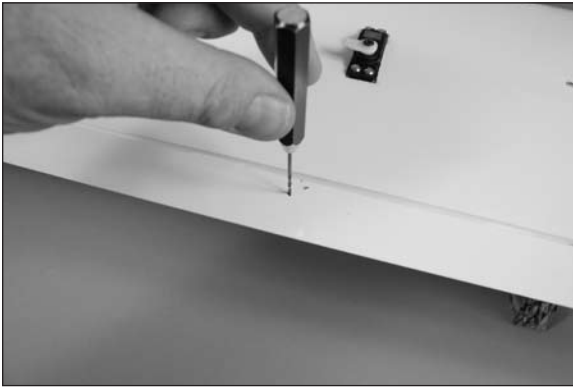

- ○ 11. Apply 2-3 drops of thin CA in each of the holes to harden the surrounding wood. This will keep the control horn secure and prevent the surrounding wood from becoming damaged over time.

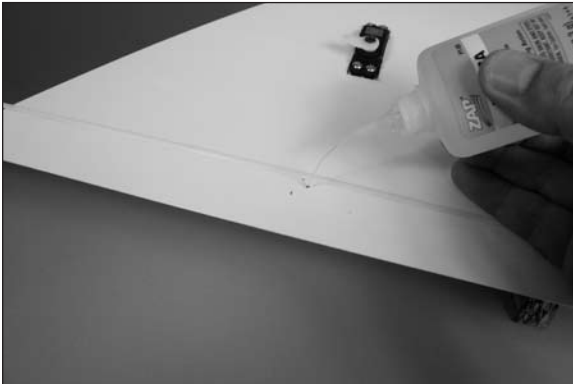

- ○ 12. Attach the control horn to the aileron using two 2mm x 12mm machine screws and the control horn backplate. Use a #1 Phillips screwdriver to tighten the screws. Make sure not to over-tighten the screws and damage the underlying wood.

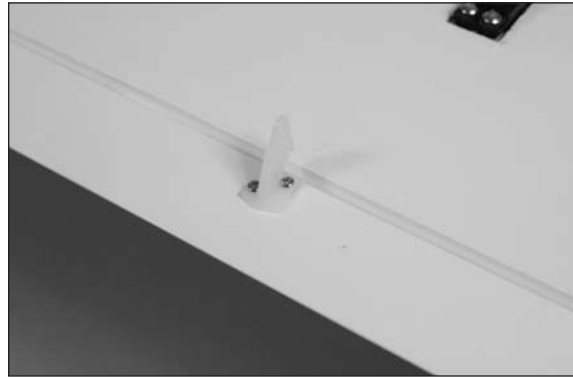

- ○ 13. Use a hobby knife with a #11 blade to cut a 1/4-inch (6mm) piece from the silicone tube.

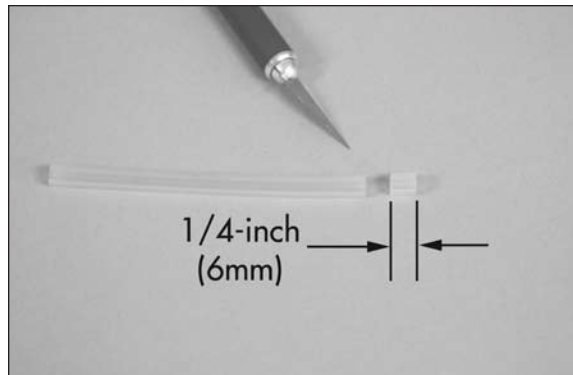

- ○ 14. Slide the small piece of tubing in a nylon clevis. Thread the clevis 12-turns on a 11<sup>7</sup>/<sub>8</sub>-inch (302mm) threaded pushrod wire. This will provide enough threads in the clevis to be secure and allow for adjustment of the linkage.

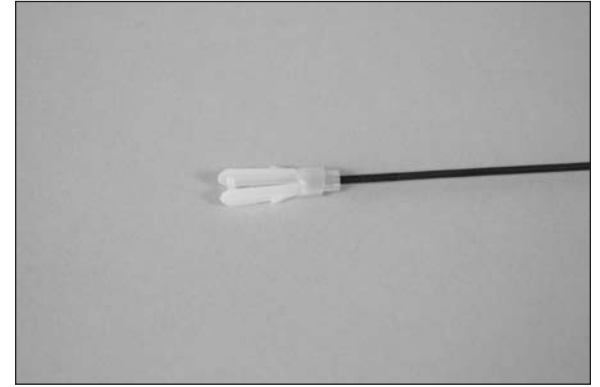

- ○ 15. Wrap a small piece of low-tack tape around the aileron and trailing edge to keep the aileron centered. Attach the clevis to the outer hole of the control horn.





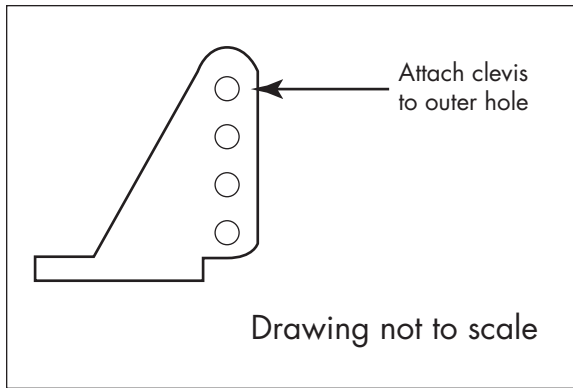

- 16. Use a felt-tipped pen to mark the pushrod where it crosses the hole in the servo horn that was enlarged in Step 6.



### ***E-tips***

Making a Z-bend takes some skill. There is plenty of excess wire to experiment with. We recommend using Z-bend pliers (HAN119) to make the perfect Z-bend in your pushrod wire.

- 17. Disconnect the clevis from the control horn. Make a Z-bend in the pushrod wire using a pair of pliers. Use side cutters to trim the excess wire to match the photo below.



- 18. Insert the bend in the hole of the servo horn. Reconnect the clevis to the outer hole of the control horn. Slide the silicone tube over the forks of the clevis to prevent it from opening accidentally in flight.

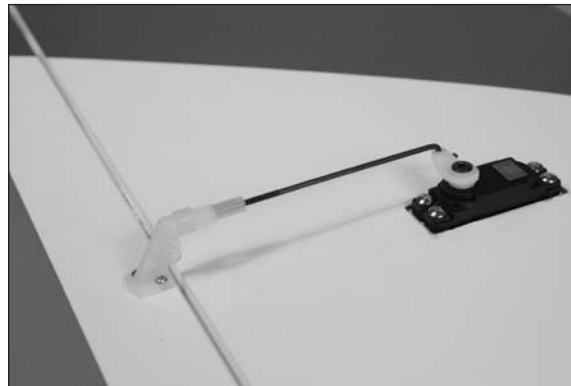

- 19. Repeat Steps 1 through 19 to install the remaining aileron servo and linkage. Remove the low-tack tape securing the aileron before joining the wing panels.

## ***Joining the Wing Panels***

### ***Required Parts***

Wing panel with aileron (left and right)  
Hardwood wing joiner

### ***Required Tools and Adhesives***

30-minute epoxy	Pencil
Low-tack tape	Paper towel
Mixing stick	Mixing cup
Epoxy brush	Rubbing alcohol
Medium grit sandpaper	

- 1. Locate the hardwood wing joiner. Mark the joiner and wing panels with an "R" and "L" so the joiner can be associated with a particular wing panel for test fitting.

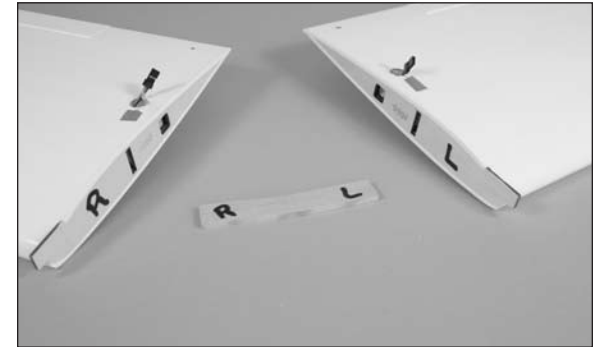

- 2. Slide the wing joiner into one of the wing panels. Use a pencil to draw a line on the joiner against the wing as shown. The joiner should easily slide into the wing panel. If not, use medium grit sandpaper to lightly sand the joiner so it slides in easily.



- 3. Slide the joiner into the opposite wing panel. It should slide in up to or past the line drawn in the previous step. If not, you will need to sand the joiner using medium grit sandpaper so it fits.



- 4. Slide the two wing panels together. They should fit together tightly with no gaps. If there are gaps, use medium grit sandpaper to make any necessary adjustments.



### ***E-tips***

The following steps must be completed before the epoxy begins to cure. Make sure to read through and understand the following steps before mixing any epoxy.

- 5. Separate the wing panels and remove the joiner. Mix 1/2 ounce (15mL) of 30-minute epoxy. Use a mixing stick to apply epoxy into the joiner pocket of one of the wing panels.

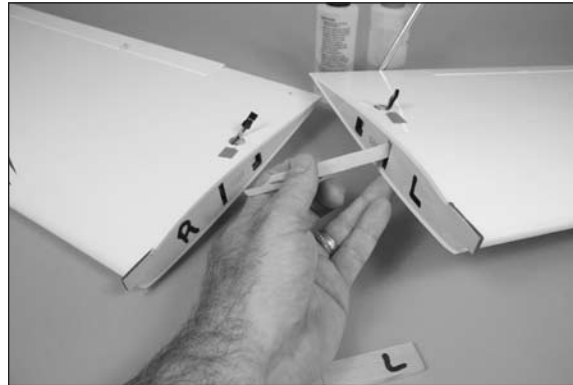

### ***E-tips***

Before applying epoxy, wrap low-tack tape 1/32-inch (1mm) from the root edge of the wing to help prevent the epoxy from running onto the wing.

- 6. Use an epoxy brush to apply a thin coat of epoxy to the exposed wood on the wing root as shown.



- 7. Use an epoxy brush to apply the epoxy to one half of the joiner. Make sure to coat the front, back, top and bottom of the joiner with epoxy.

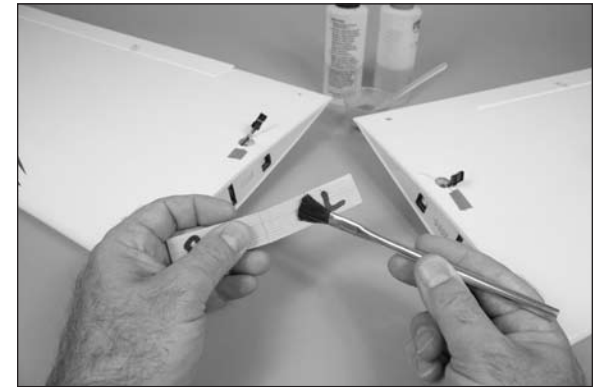

- 8. Slide the wing joiner into the wing panel. Use a paper towel and rubbing alcohol to remove any excess epoxy.



- 9. Repeat Steps 5 through 8 to apply epoxy to the exposed joiner and to the remaining wing panel. Slide the panels together and use low-tack tape to hold them tightly together until the epoxy fully cures. Make sure to use a paper towel and rubbing alcohol to remove any excess epoxy before it begins to cure.

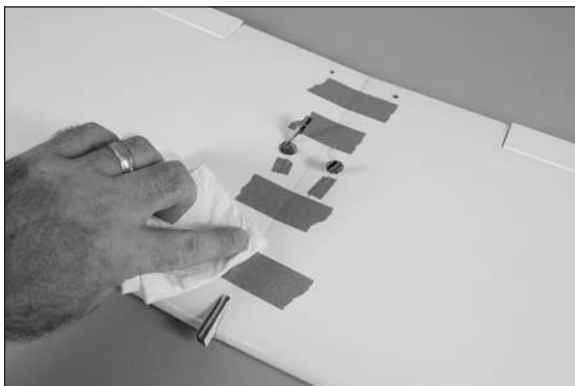

- 10. Once the epoxy has fully cured, remove the tape from the wing.

### ***Etips***

We recommend working through the next two sections of the manual to allow the epoxy to fully cure.

## **Radio Installation**

### **Required Parts**

Fuselage	Servo with hardware (2)
Transmitter	Receiver
Y-harness	Hook and loop tape

### **Required Tools and Adhesives**

Scissors	Phillips screwdriver: #1
Thin CA	Side cutter
Pin vise	Drill bit: 5/64-inch (2mm)

- 1. Prepare the rudder and elevator servos by installing the rubber grommets and brass eyelets.

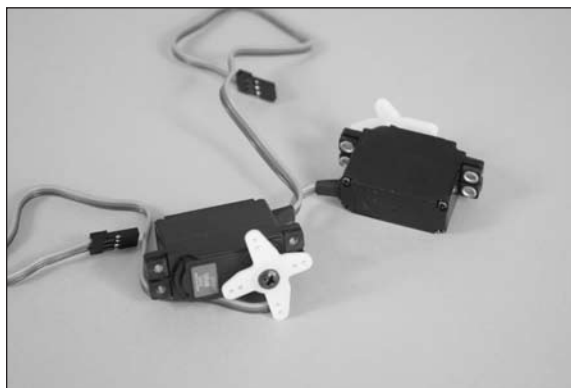

- 2. Use the radio system to center the elevator servo. Enlarge the hole in the servo arm that is 1/2-inch (13mm) from the center of the servo. Use side cutters to remove the remaining arms from the horn so they don't interfere with the operation of the servo.

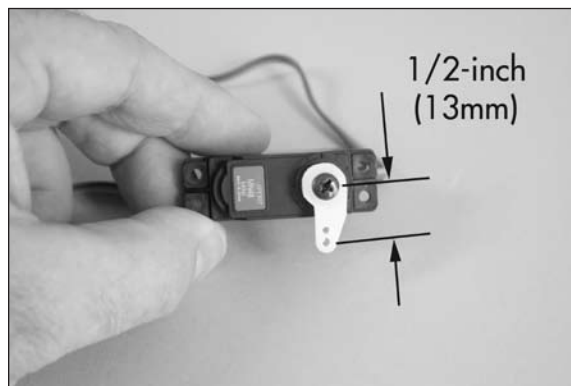

- 3. Use the radio system to center the rudder servo. Enlarge the hole in the servo arm that is 1/2-inch (13mm) from the center of the servo for the rudder pushrod. Use side cutters to remove the shorter arms from the horn so they don't interfere with the operation of the servo. Make sure to leave the two arms as shown: one connects to the rudder, the other connects to the nose gear steering. Do not enlarge any of the holes on the side of the arm for the steering pushrod.

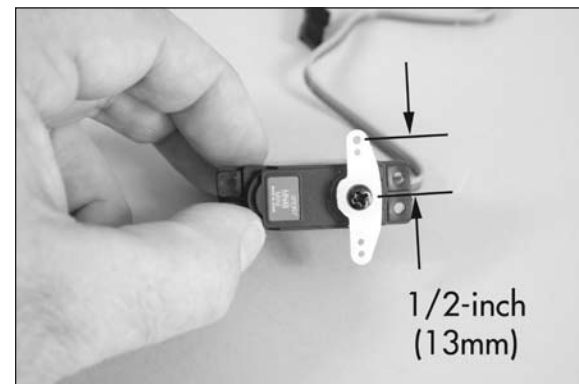

- 4. Use a #1 Phillips screwdriver to thread a servo mounting screw in each of the eight servo mounting holes. This will cut threads into the surrounding wood.



- 5. Apply 2–3 drops of thin CA in each of the servo mounting holes. This will harden the threads in the surrounding wood, which will help prevent the servo mounting screws from vibrating loose.



- 6. Mount the rudder and elevator servos in the fuselage. Make sure to guide the servo leads through the radio tray. Use a #1 Phillips screwdriver to tighten the servo mounting screws.

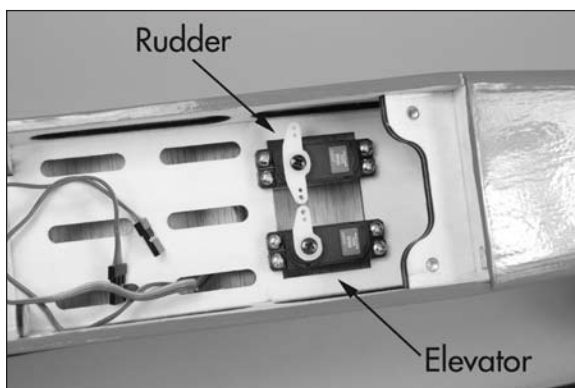

- 7. Use scissors to cut two small pieces of hook and loop tape to fit the main and remote receivers. Apply the tape to the receivers as shown.



- 8. Mount the main receiver in the fuselage using the hook and loop tape. Plug the rudder, elevator and Y-harness for the aileron servos into the receiver at this time.



- 9. Secure the remote receiver to the fuselage side using the hook and loop tape.

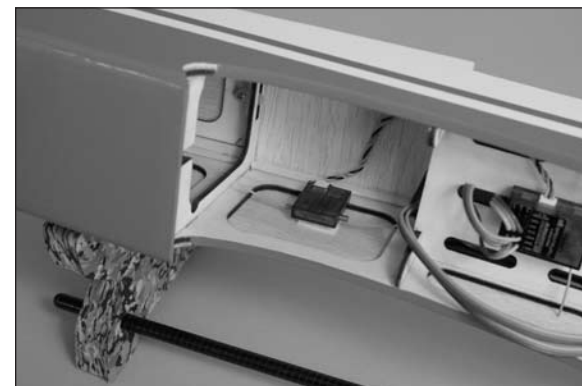

## Nose Gear Installation

### Required Parts

Fuselage assembly	Nose gear mount
Nylon clevis	Silicone tubing
Nose gear wire	Wheel, 2-inch (51mm)
Nylon spacer	3mm x 15mm machine screw (4)
Steering arm with screw	
Wheel collar with screw	
Pushrod wire, 24-inch (610mm)	
Nylon tube, 11 <sup>7</sup> / <sub>8</sub> -inch (302mm)	

### Required Tools and Adhesives

Ruler	Medium grit sandpaper
Threadlock	Phillips screwdriver: #1
Felt-tipped pen	Hobby knife with #11 blade
Pliers	Side cutter
Medium CA	Flat file

- 1. Use medium grit sandpaper to lightly sand a 1/4-inch (6mm) wide section of the 11<sup>7</sup>/<sub>8</sub>-inch (302mm) pushrod tube. This provides a surface for the CA to bond to when the pushrod is glued in the fuselage. Use the photo to locate the areas that are 2<sup>1</sup>/<sub>4</sub>-inch (57mm) and 6-inches (147mm) from the end of the tube.

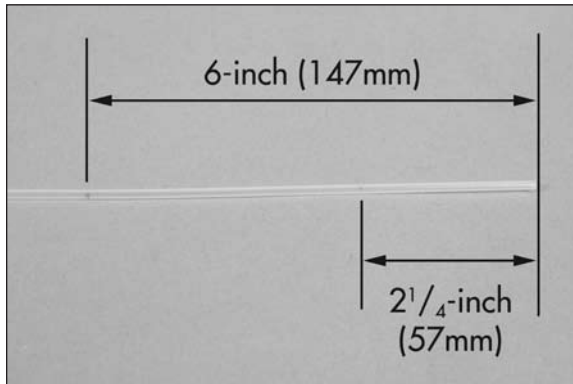

- 2. Remove the battery cover by rotating the knob on the cover 90-degrees. Lift the cover and set it aside in a safe location.

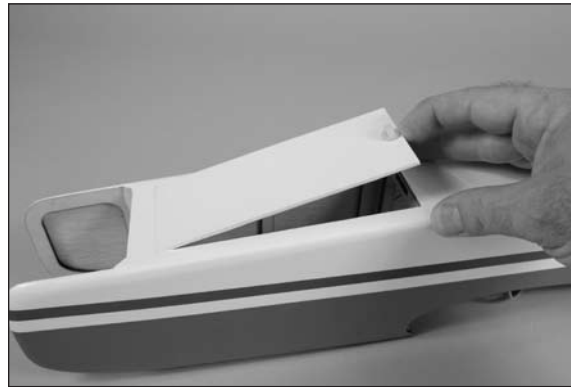

- 3. Slide the pushrod tube into the fuselage through the oval hole in the firewall with the 2<sup>1</sup>/<sub>4</sub>-inch (57mm) sanded end first. The tube will be routed up through the battery tray, then through the hole in the former near the servo tray. With the end of the tube flush with the firewall, use medium CA to glue the tube where it crosses the formers inside the fuselage.

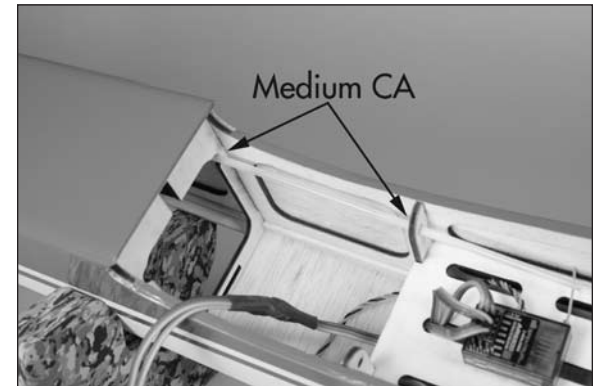
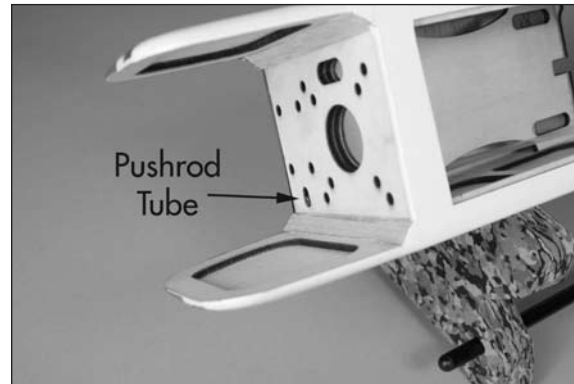

**E-tips**

Always use threadlock on metal-to-metal fasteners.

- 4. Attach the nose gear mount to the firewall using four 3mm x 15mm machine screws and a #1 Phillips screwdriver.



## ***Etips***

Always use threadlock on metal-to-metal fasteners.

- 5. Position the steering arm in the nose gear mount. Slide the nose gear wire through the mount and steering arm so it is flush with the top of the nose gear mount. The steering arm will angle away from the firewall so the nose wheel can operate properly. Use a #1 Phillips screwdriver to tighten the screw in the steering arm so it rests on the flat area on the nose gear wire.



- 6. Use a hobby knife with a #11 blade to cut a 1/4-inch (6mm) piece from the silicone tube. Slide the small piece of tubing on a nylon clevis. Thread the clevis 12-turns on a 24-inch (610mm) threaded pushrod wire. This will provide enough thread in the clevis to be secure and allow for adjustment of the linkage.

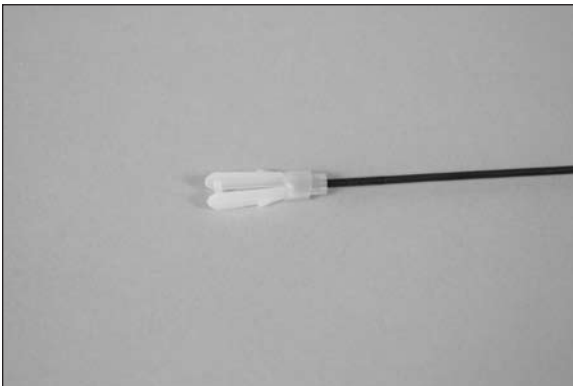

## ***Etips***

Use the rudder trim on the radio to trim the model in flight. If the model does not track straight on the runway, adjust the clevis on the steering linkage. Do not use the rudder trim to correct the steering on your model.

- 7. Slide the steering pushrod wire into the tube from the inside of the fuselage. Connect the clevis to the outer hole of the rudder servo horn.



- 8. Center the nose gear wire. The axle (where the wheel mounts) will be parallel to the firewall. Use a felt-tipped pen to mark the pushrod wire where it crosses the outer hole of the steering arm.

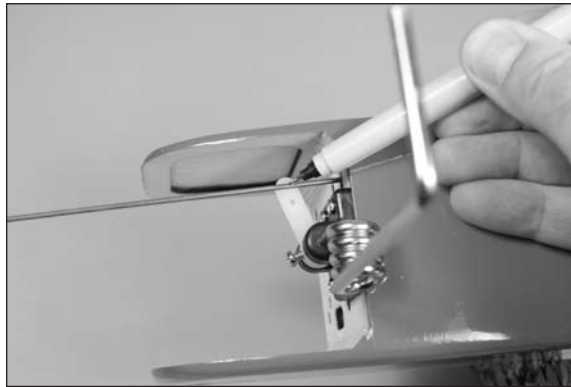

- 9. Use pliers to make a 90-degree bend in the wire. Use side cutters to trim the wire 3/8-inch (9mm) past the bend as shown.

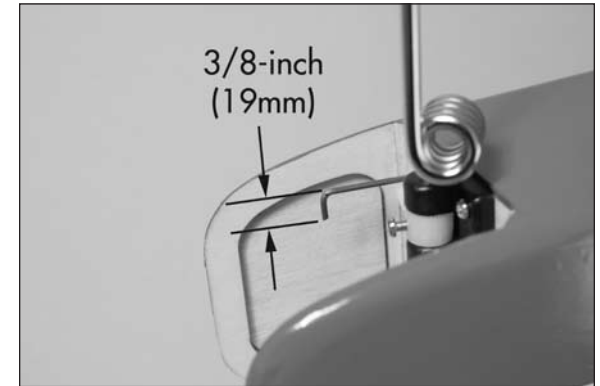

- 10. Insert the wire through the outer hole in the steering arm. You may have to disassemble the nose gear assembly to fit the wire through the hole.

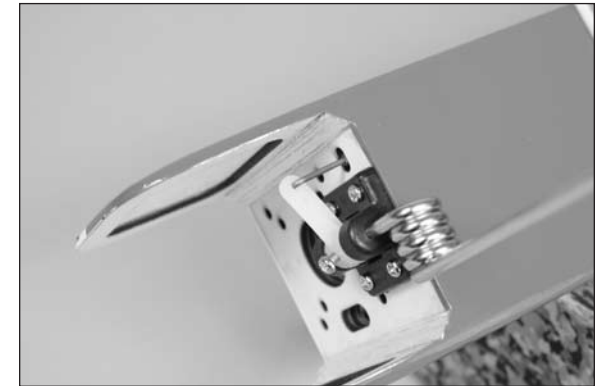

- 11. Use a flat file to make a 1/4-inch (6mm) wide flat area on the nose gear wire that is 1/2-inch (13mm) from the end of the wire. This will give the screw in the wheel collar a place to rest, making it more secure when installed.

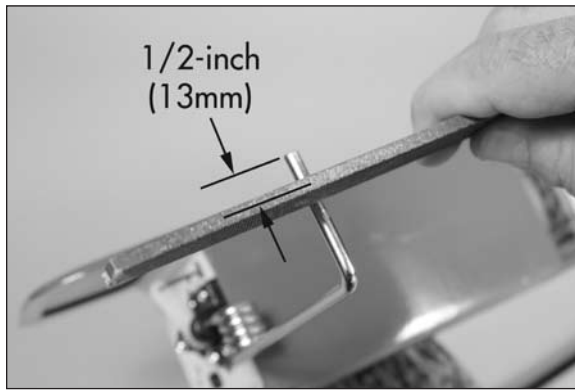

- 12. Slide the nylon spacer on the nose gear wire, then the 2-inch (51mm) wheel.



**E-tips**

Always use threadlock on metal-to-metal fasteners.

- 13. Secure the wheel to the nose gear wire using a wheel collar and a #1 Phillips screwdriver to tighten the screw.

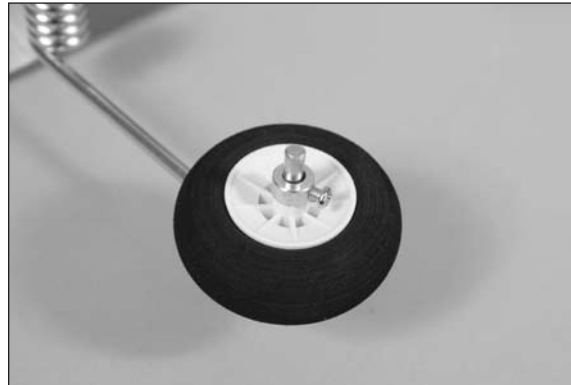

## Motor Installation

### Required Parts

Transmitter                      Fuselage assembly  
 Power 25 motor with hardware  
 40-Amp speed control (ESC) for Power 25  
 Propeller, 12 x 8  
 3200mAh 3S 11.1V motor battery (charged)  
 Hook and loop strap (2)  
 Hook and loop tape  
 Servo extension, 3-inch (76mm)

### Required Tools and Adhesives

Threadlock                      Phillips screwdriver: #2  
 Scissors                      Hex wrench: 2.5mm

### Optional Required Parts

Power 32 motor with hardware  
 60-Amp speed control (ESC) for Power 32  
 Plywood adapter plate for Power 32  
 Propeller, 12 x 6  
 3200mAh 4S 14.8V motor battery (charged)

### Optional Tools and Accessories

Spinner  
 Box wrench: 10mm  
 Hex wrench: 3/32-inch

**E-tips**

Always use threadlock on metal-to-metal fasteners.

- 1. Use a #2 Phillips screwdriver to attach the X-mount to the back of the motor using the hardware provided with the motor.





Power 32

### ***E-tips***

Always use threadlock on metal-to-metal fasteners.

#### **POWER 25 SPECIFIC**

- 2. Attach the motor to the firewall using the hardware provided with the motor. Guide the leads from the motor through the hole in the firewall. Use a 2.5mm hex wrench to tighten the bolts securing the motor to the firewall.



#### **POWER 32 SPECIFIC**

- 2A. Locate the plywood spacer. The spacer will be placed between the motor and firewall. Check the fit of the spacer, as it will be notched for the nose gear mount and will line up with the holes in the firewall for the motor. There is a front and back to the spacer, so if the holes don't line up, flip it around so that they do.



- 2B. Guide the leads from the motor through the hole in the firewall. Use the hardware provided with the motor to attach it to the firewall. Use a 2.5mm hex wrench to tighten the bolts securing the motor to the firewall.



- 3. Insert the hook and loop straps through the slots in the battery tray. Make sure not to get the steering pushrod inside the straps as this will cause the steering linkage to bind, possibly damaging the rudder servo.



### ***E-tips***

Matching the colors between the ESC and motor when they are connected results in the correct motor direction if using all E-flite components.

- 4. Connect the leads from the motor to the leads from the speed control. Use hook and loop tape to secure the speed control inside the fuselage as shown.

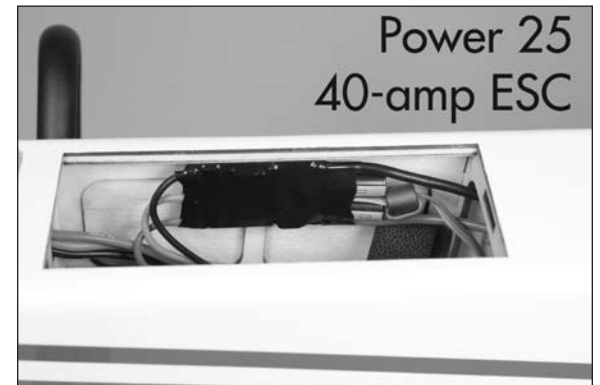

Power 25  
40-amp ESC



## ***E-tips***

When mounting the 60-amp speed control for the Power 32, make sure to secure the switch on the speed control where it can be easily accessed.

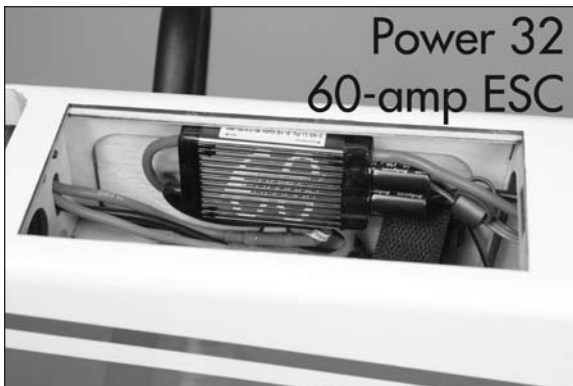

- 5. Connect the lead from the speed control to the receiver using a 3-inch (76mm) servo extension.

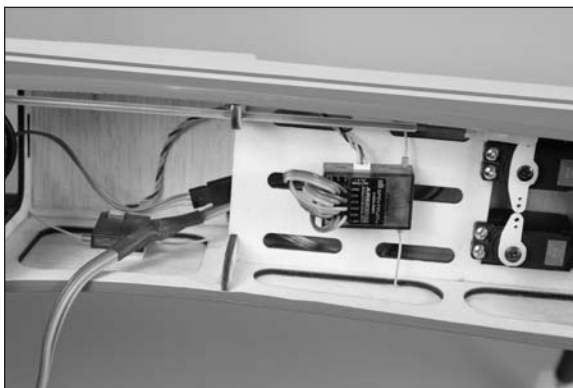

- 6. Apply the remaining hook and loop tape to the bottom of the battery. This will keep the battery from moving forward or aft in the fuselage.



- 7. Use the hook and loop straps to secure the battery to the battery tray.



- 8. Turn on the transmitter. Connect the battery to the power lead of the speed control. Check the rotation of the motor to make sure it rotates counterclockwise when viewed from the front of the fuselage. If not, swap any two of the motor leads to correct the direction of rotation.

## ***E-tips***

Always balance your propeller. An unbalanced propeller can cause vibrations to be transmitted into the airframe, which could damage the airframe or other components as well as produce unwanted flight characteristics.

- 9. Use the propeller adapter to secure the propeller to the motor. Slide a 2.5mm-inch hex wrench through the hole in the adapter to tighten it, securing the propeller.



## ***E-tips***

We recommend using the optional spinner to enhance the looks of your model.

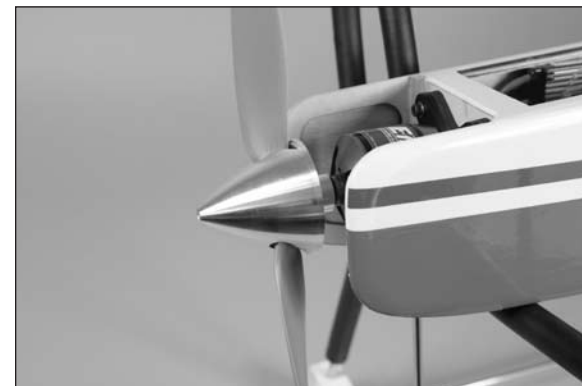

## Main Landing Gear Installation

### Required Parts

Wing assembly      Main gear wire (2)  
Nylon spacer (2)    Nylon landing gear strap (4)  
3mm x 10mm sheet metal screw (8)  
Wheel collar with screw (2)  
Wheel, 2<sup>1</sup>/<sub>4</sub>-inch (57mm) (2)

### Required Tools and Adhesives

Flat file              Phillips screwdriver: #1  
Drill                  Drill bit: 1/16-inch (1.5mm)  
Thin CA              Threadlock  
Low-tack tape        Ruler  
Felt-tipped pen

- 1. Insert the landing gear into the channel in the bottom of the wing. The gear will fit flush with the bottom of the wing.



- 2. Use a felt-tipped pen and ruler to make two marks that are 1/2-inch (13mm) from the ends of the wire as shown.

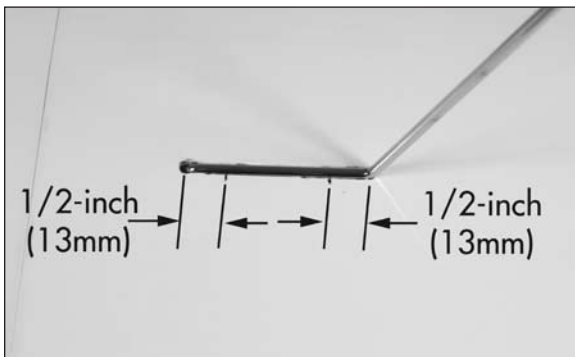

- 3. Center the nylon landing gear strap over the gear wire and the mark made in the previous step. Use a felt-tipped pen to transfer the locations for the mounting screws to the bottom of the wing.

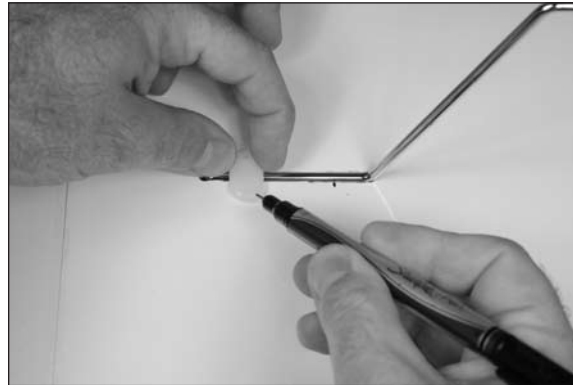

### E-tips

Wrap a small piece of low-tack tape around a 1/16-inch drill bit so it is 1/2-inch (13mm) from the end of the bit. This will help in preventing drilling through the top of the wing when drilling the holes for the mounting screws.

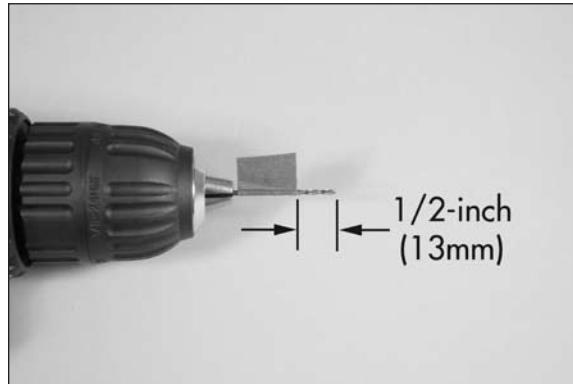

- 4. Use a drill and 1/16-inch (1.5mm) drill bit to drill the four holes for the landing gear strap mounting screws.

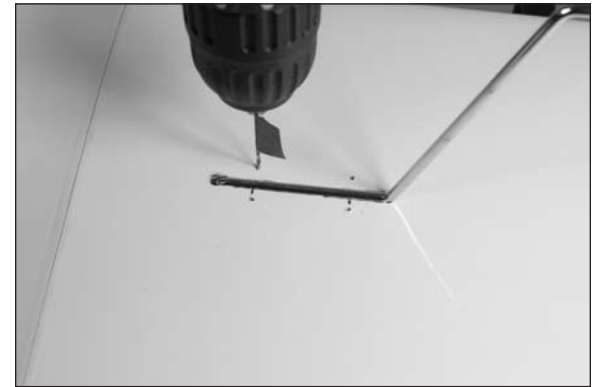

- 5. Use a #1 Phillips screwdriver to thread a 3mm x 10mm sheet metal screw in each of the holes. This will cut threads into the surrounding wood.

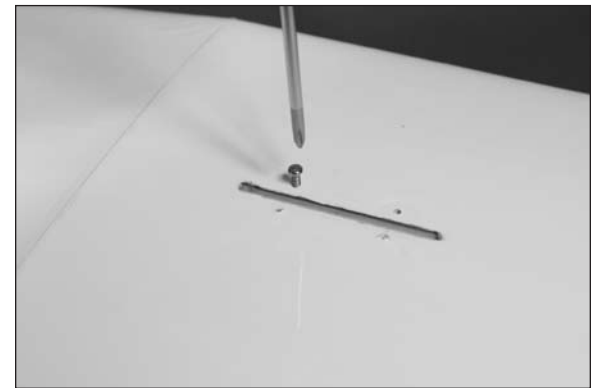

- 6. Apply 2–3 drops of thin CA in each of the holes. This will harden the threads in the surrounding wood, which will help prevent the screws from vibrating loose.

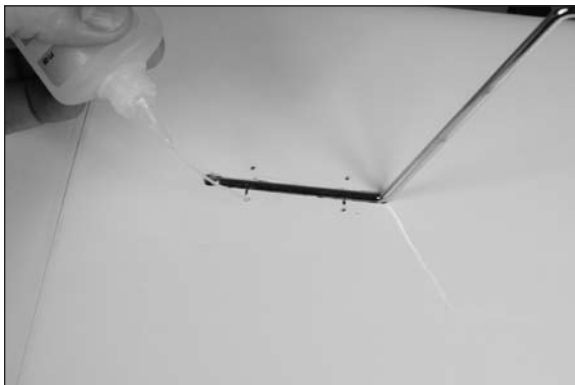

- 7. Use a #1 Phillips screwdriver to attach the nylon landing gear straps using four 3mm x 10mm sheet metal screws.

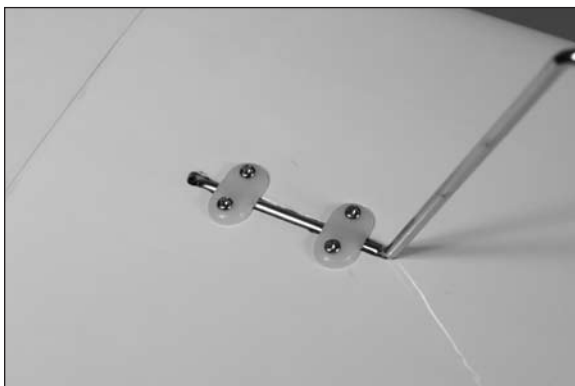

- 8. Use a flat file to make a 1/4-inch (6mm) wide flat area on the main gear wire that is 1/2-inch (13mm) from the end of the wire. This will give the screw in the wheel collar a place to rest, making it more secure when installed.

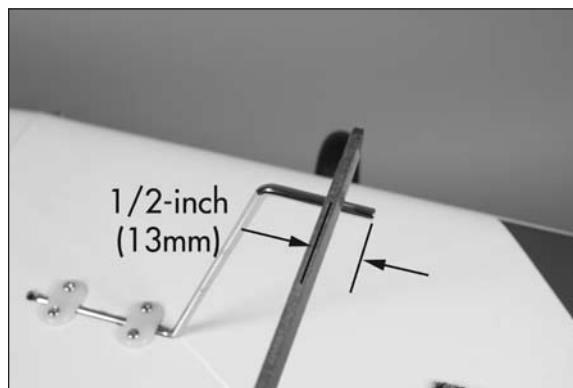

- 9. Slide the nylon spacer on the main gear wire, then the 2 1/4-inch (57mm) wheel.



- 10. Secure the wheel to the main gear wire using a wheel collar and a #1 Phillips screwdriver to tighten the screw.



- 11. Repeat Steps 1 through 10 to install the remaining main gear wire and wheel.

***Etips***

Always use threadlock on metal-to-metal fasteners.

## Wing Installation

### Required Parts

Wing assembly      Fuselage assembly  
4mm x 25mm machine screws  
Plywood wing bolt plate

### Required Tools and Adhesives

Felt-tipped pen      Hobby knife with #11 blade  
Medium CA          Phillips screwdriver: #2  
Paper towel          Rubbing alcohol

## *E-tips*

Before installing the wing bolt plate, draw a centerline on the underside of the plate and lightly score the plate so it can easily conform to the dihedral angle of the wing. Use care not to cut through the plate.

- 1. Place the plywood wing bolt plate on the bottom of the wing. Trace the outline of the wing bolt plate on the bottom of the wing. We used the two 4mm x 25mm machine screws to keep the plate in the correct position.



## *E-tips*

When cutting through the covering, use a new #11 blade and light pressure to avoid cutting into the underlying wood, which could weaken the underlying structure, causing it to fail in flight. We also recommend using a hot knife to melt through the covering to help reduce damaging the underlying wood.

- 2. Remove the plate from the wing. Use a hobby knife and #11 blade to trim the covering inside the lines drawn in the previous step by 1/16-inch (1.5mm). Remove the covering, exposing the bare wood. The lines can be removed using a paper towel and rubbing alcohol.

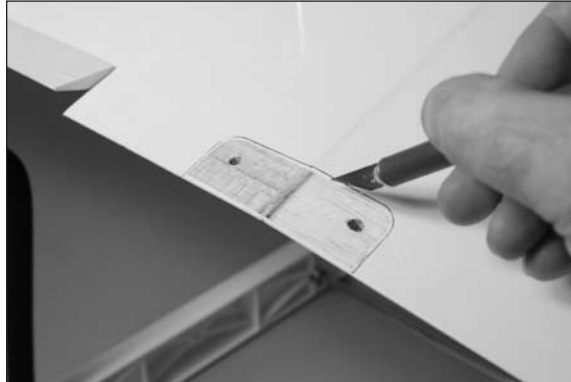

- 3. Use medium CA to glue the wing bolt plate to the bottom of the wing. Make sure the holes are aligned before the CA fully cures.



- 4. Connect the leads between the aileron Y-harness and aileron servos.



- 5. Place the wing on the fuselage. Make sure the aileron servo leads are tucked in and not exposed between the wing and fuselage. Use two 4mm x 25mm machine screws and a #2 Phillips screwdriver to secure the wing to the fuselage.



## Stabilizer and Vertical Fin Installation

### Required Parts

Airframe                      Stabilizer with elevator  
Fin with rudder

### Required Tools and Adhesives

Ruler                      Phillips screwdriver: #2  
30-minute epoxy        Hobby knife with #11 blade  
Felt-tipped pen         Square  
Low-tack tape         Paper towel  
Mixing stick             Mixing cup  
Epoxy brush             Rubbing alcohol  
T-pins                     Medium grit sandpaper

- 1. Use a ruler and felt-tipped pen to draw a reference line down the center of the stabilizer saddle.



- 2. Separate the elevator and stabilizer. Leave the six hinges in the elevator so they don't get lost. Set the elevator aside in a safe location to be installed later.

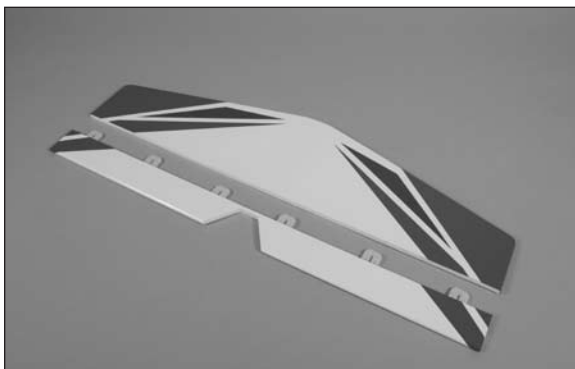

- 3. Use a hobby knife and a #11 blade to remove the covering from the center slot of the stabilizer.

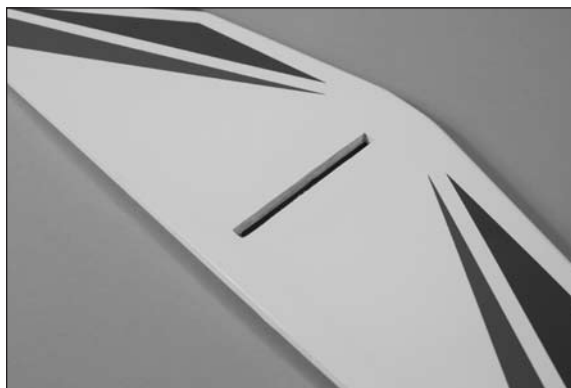

- 4. Place the stabilizer on the fuselage. Use the line drawn on the stabilizer saddle in Step 1 to help align the slot in the stabilizer on the stabilizer saddle. With the stabilizer as far forward on the saddle as possible, use two T-pins to keep the stabilizer in position to check its alignment.

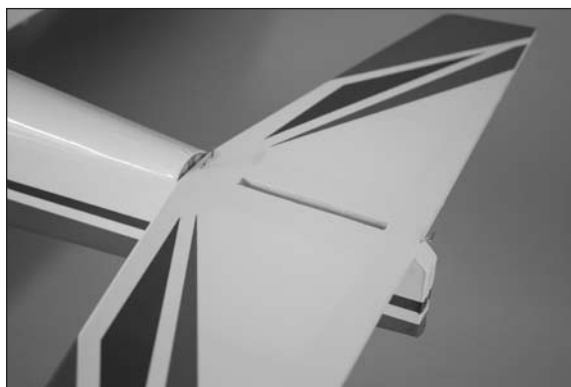

***Etips***

It is important to check the alignment of the stabilizer in relationship to the wing. Not doing so may cause your airplane to require excessive amounts of trim to correct for poor alignment, resulting in poor flight performance.

- 5. Measure the distance from each stabilizer tip to the fuselage centerline to make sure the stabilizer is centered on the fuselage ( $A=A$ ). Measure the distance from each stabilizer tip to its respective wing tip ( $B=B$ ). These measurements must match as close as possible. Adjust the position of the stabilizer if necessary to position the stabilizer.

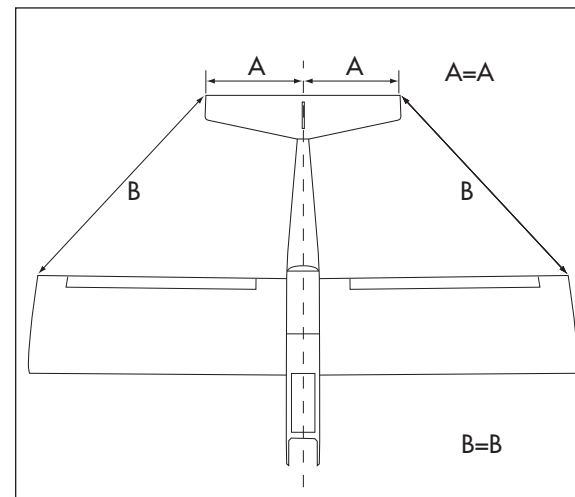

- 6. Stand back 8–10 feet (2–3 meters) and view the aircraft from the rear. Check the alignment between the wing and stabilizer. They must be equal distance on each side as shown. If not, lightly sand the stabilizer saddle to correct any alignment problems.

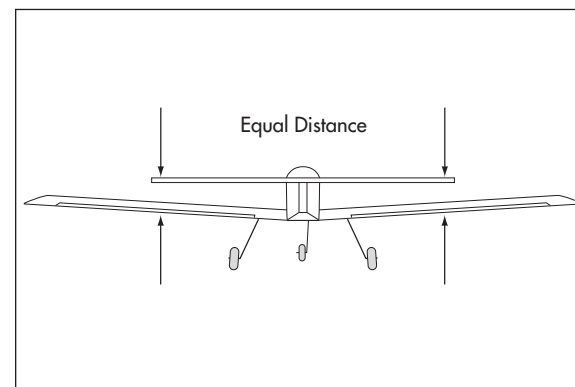

- 7. Once the stabilizer has been aligned to the wing, use a felt-tipped pen to trace the outline of the fuselage on the bottom of the stabilizer.



### ***E-tips***

When cutting through the covering, use a new #11 blade and light pressure to avoid cutting into the underlying wood, which could weaken the underlying structure, causing it to fail in flight. We also recommend using a hot knife to melt through the covering to help reduce damaging the underlying wood.

- 8. Remove the stabilizer from the fuselage. Use a hobby knife and #11 blade to trim the covering inside the lines drawn in the previous step by 1/16-inch (1.5mm). Remove the covering, exposing the bare wood. The lines can be removed using a paper towel and rubbing alcohol.



### ***E-tips***

The following steps must be completed before the epoxy begins to cure. Make sure to read through and understand the following steps before mixing any epoxy.

- 9. Mix 1/2 ounce (15mL) of 30-minute epoxy. Apply a thin coat of epoxy on the stabilizer saddle with an epoxy brush.



- 10. Use an epoxy brush to apply a thin coat of epoxy to the exposed wood on the stabilizer.

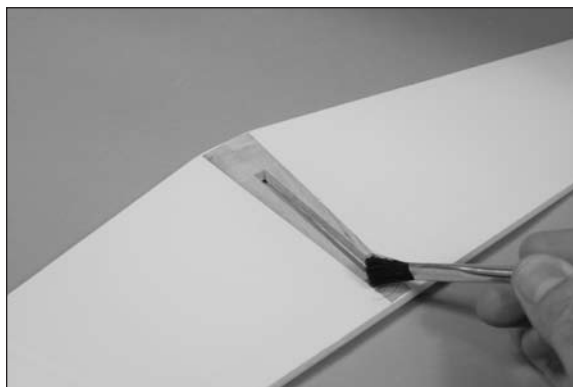

- 11. Place the stabilizer back on the fuselage. Recheck the alignment, then use T-pins to hold the stabilizer in position. Use a paper towel and rubbing alcohol to remove any excess epoxy before it cures. Set the fuselage aside until the epoxy fully cures.

### ***E-tips***

Use care not to get epoxy in the slot at the center of the stabilizer. This will change the fit of the fin in the slot when it is installed.

- 12. Once the epoxy has fully cured, use a #2 Phillips screwdriver to remove the wing from the fuselage. Set the wing aside in a safe location until instructed to install it again.
- 13. Separate the rudder from the fin. Leave the three hinges in the rudder so they don't get lost. Set the rudder aside in a safe location to be installed later.

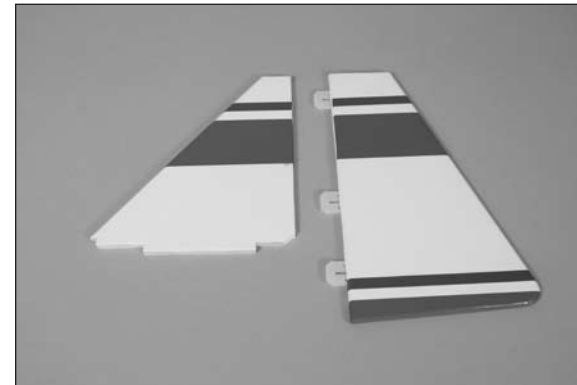

- 14. Remove the T-pins from the stabilizer. Position the fin in the slot in the stabilizer. It must rest tightly against the stabilizer. Use a felt-tipped pen to transfer the top edge of the stabilizer on the bottom of the fin.

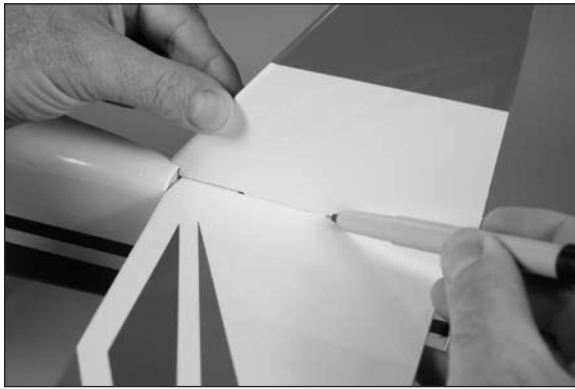

- 15. Use a felt-tipped pen to trace the outline of the fin on the top of the stabilizer.

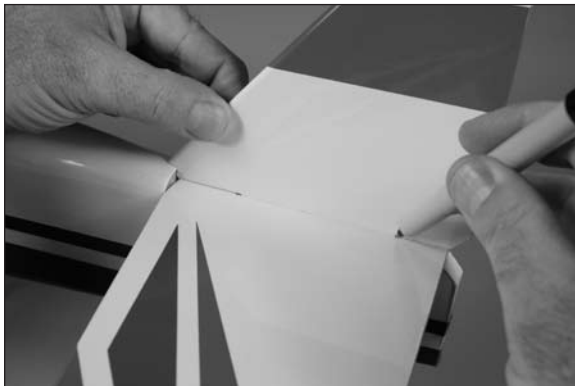

### ***Etips***

When cutting through the covering, use a new #11 blade and light pressure to avoid cutting into the underlying wood, which could weaken the underlying structure, causing it to fail in flight. We also recommend using a hot knife to melt through the covering to help reduce damaging the underlying wood.

- 16. Use a hobby knife and #11 blade to remove the covering from the fin 1/16-inch (1.5mm) below the line drawn in the previous steps.

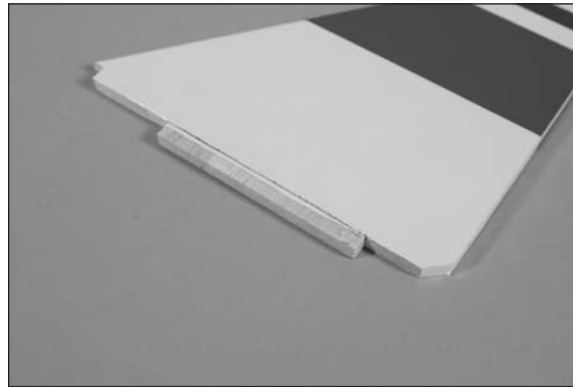

- 17. Use a hobby knife and #11 blade to trim the covering inside the lines drawn on the stabilizer by 1/16-inch (1.5mm). Remove the covering, exposing the bare wood. The lines can be removed using a paper towel and rubbing alcohol.

### ***Etips***

The following steps must be completed before the epoxy begins to cure. Make sure to read through and understand the following steps before mixing any epoxy.

- 18. Mix 1/2 ounce (15mL) of 30-minute epoxy. Apply a thin coat of epoxy to the exposed wood and in the slot on the top of the stabilizer.



- 19. Apply a thin coat of epoxy to the exposed wood at the bottom of the fin.

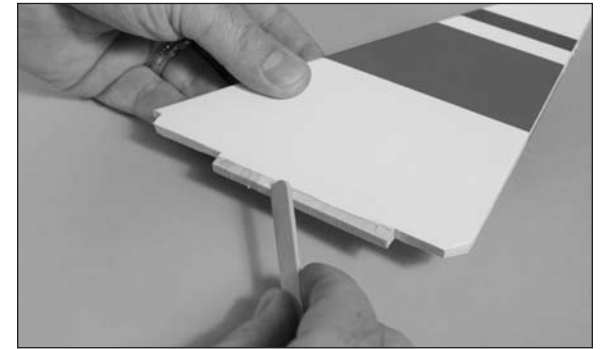

- 20. Place the fin in position in the slot. Use a square to make sure the fin is perpendicular to the stabilizer.

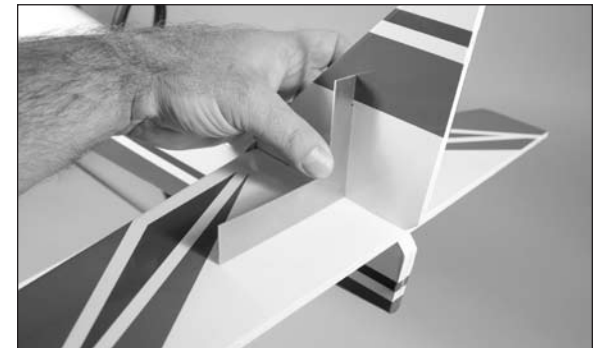

- 21. Use low-tack tape and T-pins to keep the fin in position until the epoxy fully cures. Use a paper towel and rubbing alcohol to remove any excess epoxy before it cures.

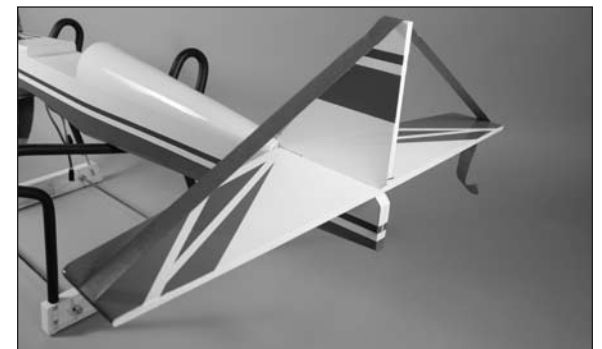

## Hinging the Elevator and Rudder

### Required Parts

Fuselage assembly Rudder with hinges  
Elevator with hinges

### Required Tools and Adhesives

Pin vise Drill bit: 1/16-inch  
Thin CA T-pins

- 1. Use a pin vise and 1/16-inch (1.5mm) drill bit to drill a hole in the center of each hinge slot in the stabilizer. This will provide a tunnel for the CA to wick into, making the bond between the hinge and wood stronger.

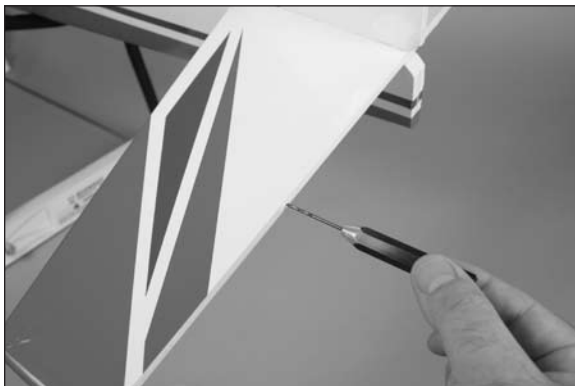

- 2. Remove the hinges from the elevator. Prepare the elevator for hinging following the procedure described in Step 1.

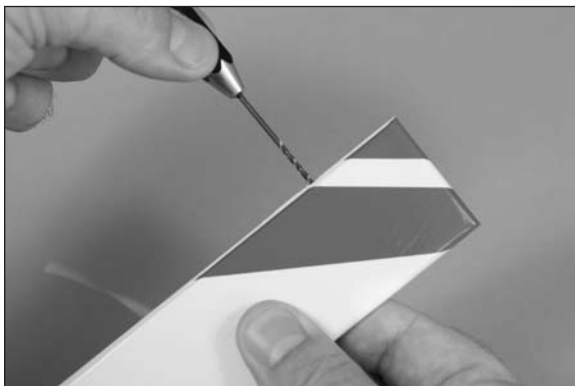

- 3. Slide the hinges into the elevator. Insert the hinges so the holes in the hinge are at the hinge line. Insert a T-pin through one of the holes to keep the hinge centered when the elevator is installed on the stabilizer.

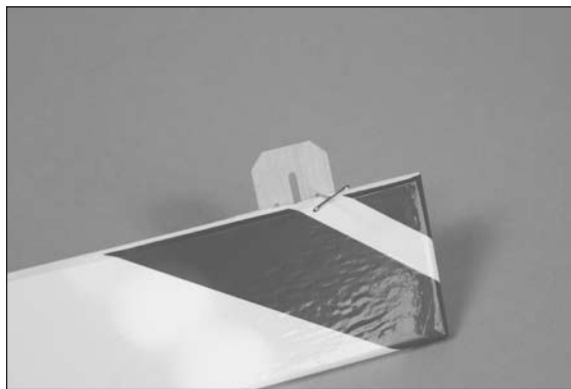

- 4. Slide the six hinges in the elevator into the slots on the stabilizer. Check that the ends of the elevator are aligned with the ends of the stabilizer.



## ***E-tips***

When gluing the hinges, do not use a CA accelerator. The CA must be allowed time to soak into the hinges to provide the best bond between the hinge and surrounding wood.

- 5. Remove the T-pins from the hinges. Make sure the elevator is tight against the stabilizer. Wick thin CA into each hinge, both top and bottom, until the hinge is saturated with CA. Allow the CA to fully cure before proceeding.



- 6. Once the CA has fully cured, gently pull on the elevator and stabilizer to make sure the hinges are glued securely. If not, reapply thin CA to any hinges that are not secure.

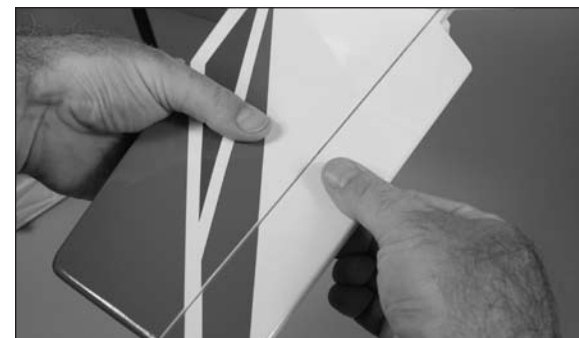



- 7. Flex the elevator through its range of motion a number of times to break in the hinges. This will reduce the initial load on the servo for your first flights.

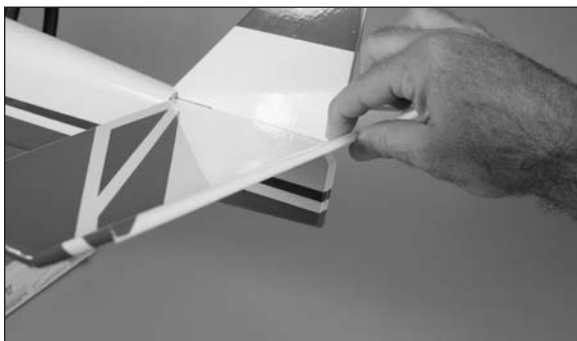

- 8. Repeat Steps 1 through 7 to attach the rudder to the fin and fuselage using three CA hinges.

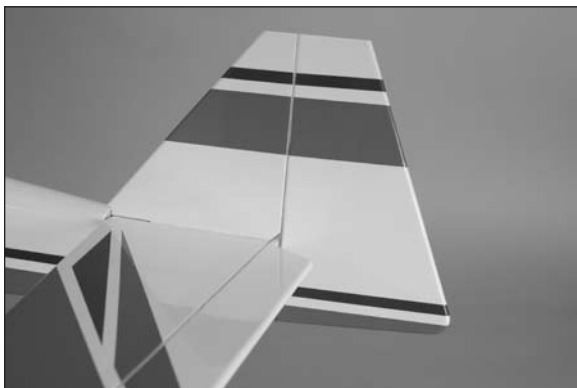

## Rudder and Elevator Linkage Installation

### Required Parts

Fuselage assembly Transmitter  
 Silicone tubing Nylon clevis (2)  
 Nylon control horn with backplate (2)  
 2mm x 12mm machine screw (4)  
 Pushrod wire, 24-inch (610mm) (2)

### Required Tools and Adhesives

Pin vise Drill bit: 5/64-inch (2mm)  
 Pliers Felt-tipped pen  
 Thin CA Hobby knife with #11 blade  
 Ruler Phillips screwdriver: #1  
 Side cutter

- 1. Use a hobby knife with a #11 blade to cut a 1/4-inch (6mm) piece from the silicone tube. Slide the small piece of tubing on a nylon clevis. Thread the clevis 12-turns on a 24-inch (610mm) threaded pushrod wire. This will provide enough thread in the clevis to be secure and allow for adjustment of the linkage.



- 2. Attach the clevis to the outer hole on the nylon control horn.

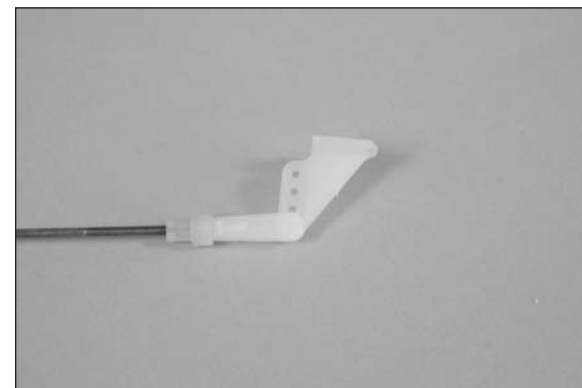

- 3. Slide the pushrod in the preinstalled elevator pushrod tube.

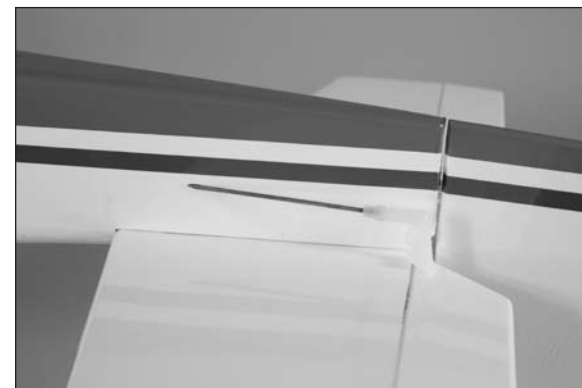

- 4. Rest the control horn on the elevator so the holes in the horn align with the elevator hinge line. The pushrod wire will help aligning the horn. Use a felt-tipped pen to mark the locations for the control horn screws.

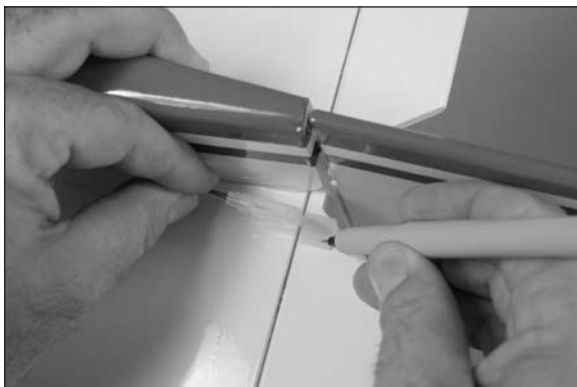

- 5. Use a pin vise and 5/64-inch (2mm) drill bit to drill the two holes for the elevator control horn mounting screws.



- 6. Apply 2–3 drops on thin CA in each of the holes to harden the surrounding wood. This will keep the control horn secure and prevent the surrounding wood from becoming damaged over time.

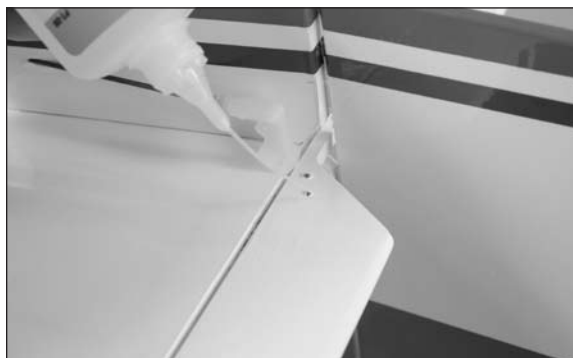

- 7. Attach the control horn to the elevator using two 2mm x 12mm machine screws and the control horn backplate. Use a #1 Phillips screwdriver to tighten the screws. Make sure not to over-tighten the screws and damage the underlying wood.



- 8. Use a ruler to check that the elevator and stabilizer are in alignment with one another.

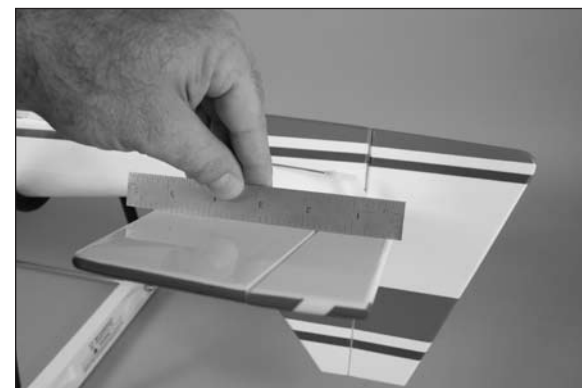

- 9. Use the radio system to center the elevator servo. Use a felt-tipped pen to mark the pushrod where it crosses the hole in the elevator servo horn that was enlarged previously.



### ***Etips***

Making a Z-bend takes some skill. There is plenty of excess wire to experiment with. We recommend using Z-bend pliers (HAN119) to make the perfect Z-bend in your pushrod wire.

- 10. Make a Z-bend in the pushrod wire using a pair of pliers. It may be necessary to disconnect the clevis from the control horn to make the bend in the pushrod wire.

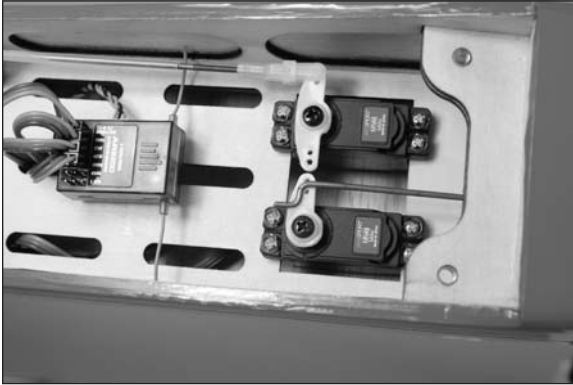

- 11. Remove the servo horn from the servo. Insert the bend in the hole of the servo horn. Secure the control horn back on the servo using a #1 Phillips screwdriver. Reconnect the clevis to the outer hole of the control horn. Slide the silicone tube over the forks of the clevis to prevent it from opening accidentally in flight. Use side cutters to remove any excess pushrod that might interfere with the operation of the radio system.

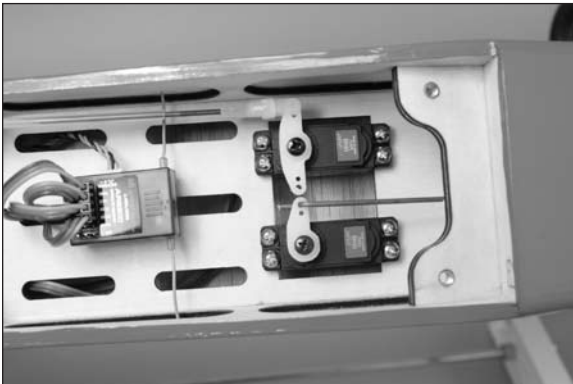

- 12. Repeat Steps 1 through 11 to install the rudder linkage.

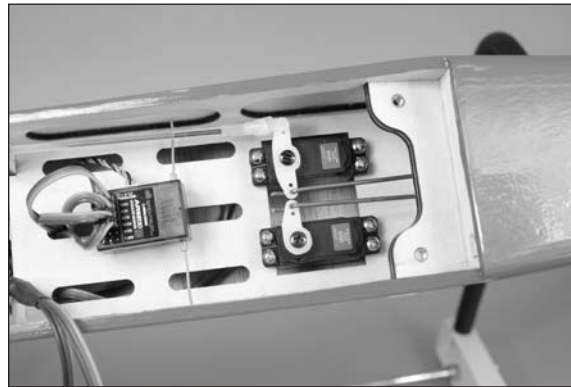
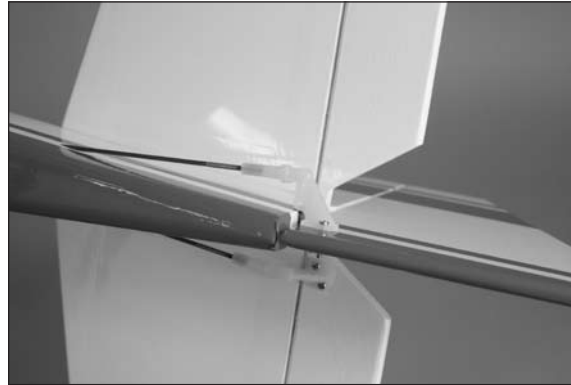

## Optional Pilot Installation

### Required Parts

Fuselage assembly Pilot

### Required Tools and Adhesives

Felt-tipped pen Scissors  
Silicone adhesive Hobby knife with #11 blade

**Note:** Skip to the next section of the manual if you are not installing the optional pilot.

- 1. Use a felt-tipped pen to trace a line on the pilot figure that is up 1/4-inch (6mm) from the bottom of the pilot.



- 2. Use a hobby knife and scissors to trim the pilot along the line drawn in the previous step.



- 3. Use silicone adhesive to glue the pilot figure in the cockpit. The pilot will be centered 2-inches (52mm) forward of the back of the cockpit as shown.

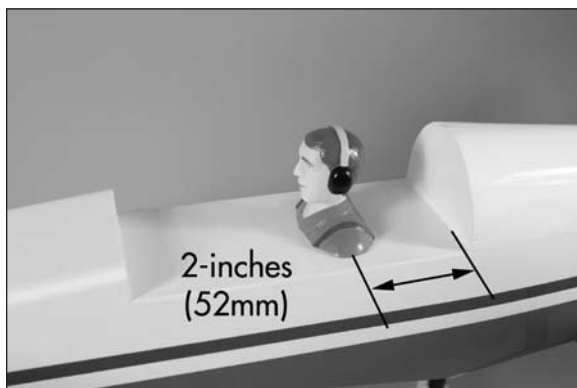

## Canopy Installation - Option 1

### Required Parts

Fuselage assembly Canopy  
2mm x 8mm sheet metal screw (4)

### Required Tools and Adhesives

Drill Drill bit: 1/16-inch (1.5mm)  
Low-tack tape Thin CA  
Phillips screwdriver: #1

We show two different options for the canopy installation. The second option can be found on Page 29.

- 1. Use low-tack tape to tape the canopy to the fuselage. Make sure it is centered left-to-right on the fuselage.



- 2. Use a pin vise and 1/16-inch (1.5mm) drill bit to drill four mounting holes for the canopy. Position the holes as far forward and rearward as possible.



- 3. Remove the canopy from the fuselage. Apply 2-3 drops of thin CA in each hole to harden the surrounding wood. Allow the CA to fully cure to prevent getting any on the canopy.

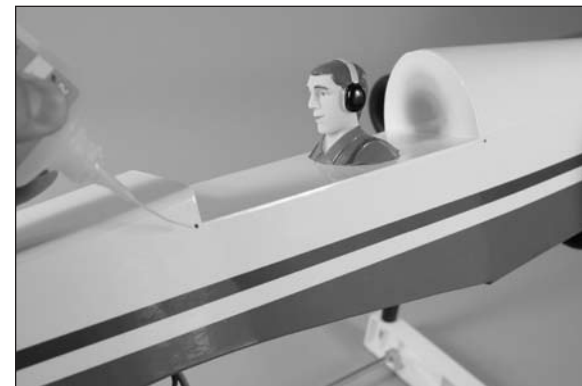

- 4. Attach the canopy using four 2mm x 8mm sheet metal screws and a #1 Phillips screwdriver.



## Canopy Installation - Option 2

### Required Parts

Fuselage assembly   Canopy  
Striping tape

### Required Tools and Adhesives

Low-tack tape   Canopy glue

- 1. Apply a thin bead of canopy glue around the perimeter of the canopy.

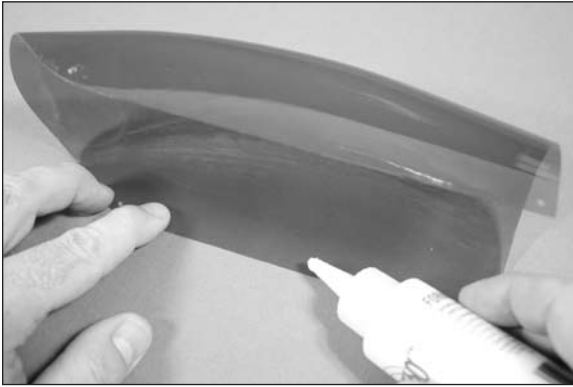

- 2. Use low-tack tape to hold the canopy in position on the fuselage. Make sure it is centered left-to-right on the fuselage.



- 3. Remove the low-tack tape once the glue has fully cured. Apply the striping tape around the edge of the canopy. Work slowly, pulling the tape to stretch it around the curves at the front of the canopy.



## Decal Installation

### Required Parts

Fuselage assembly   Wing assembly

### Required Tools and Adhesives

Spray bottle   Dish washing detergent  
Paper towel   Hobby knife with #11 blade

- 1. Apply the decals to your model using the photos located in this section of the manual and the box art from your model. Use a spray bottle and a drop of dish washing liquid sprayed in the location of the decal to allow repositioning of the decal. Use a paper towel as a squeegee to remove excess water from under the decal. Allow the model to rest overnight so the remaining water can evaporate.



## Center of Gravity

### Required Parts

Assembled airframe

### Required Tools and Adhesives

Felt-tipped pen Ruler

Phillips screwdriver: #2

Balancing stand (optional)

An important part of preparing the aircraft for flight is properly balancing the model.



**CAUTION:** Do not inadvertently skip this step or property damage and injury could occur.

- 1. Assemble your model in preparation for flight, making sure the wing is on securely and the motor battery is installed as instructed in this manual.
- 2. The recommended Center of Gravity (CG) location for your model is 3 to 3 $\frac{1}{2}$  inches (76 to 89mm) back from the leading edge of the wing as shown with the battery pack installed. Mark the location of the CG on the top of the wing with a felt-tipped pen.

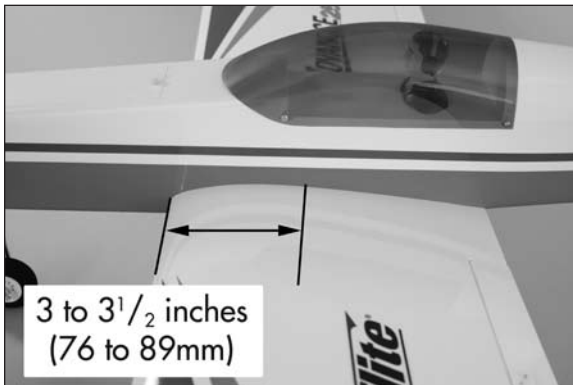

- 3. When balancing your model, support the plane inverted at the marks made on the top of the wing with your fingers or a commercially available balancing stand. This is the correct balance point for your model. Make sure your model is assembled and ready for flight before balancing.

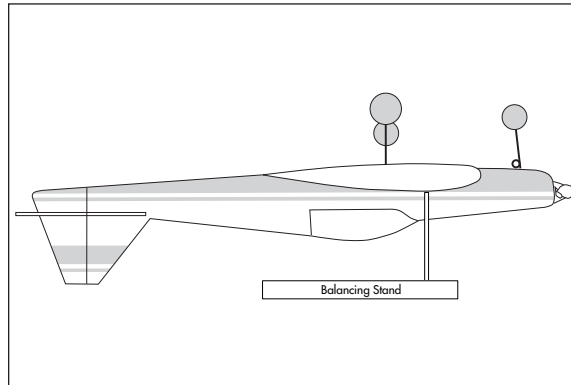

Adjust the motor battery as necessary so the model is level or slightly nose down. This is the correct balance point for your model. You should find the CG to be very close with the battery installed as shown in this manual. Mark the location of the battery on the battery tray using a felt-tipped pen so it can be returned to this position if it is removed from your model.

After the first flights, the CG position can be adjusted for your personal preference.

## Control Throws

- 1. Turn on the transmitter and receiver of your model. Check the movement of the rudder using the transmitter. When the stick is moved right, the rudder should also move right. Reverse the direction of the servo at the transmitter if necessary.
- 2. Check the movement of the elevator with the radio system. Moving the elevator stick toward the bottom of the transmitter makes the airplane elevator move up.
- 3. Check the movement of the ailerons with the radio system. Moving the aileron stick right makes the right aileron move up and the left aileron move down.
- 4. Use a ruler to adjust the throw of the elevator, ailerons and rudder. Adjust the position of the pushrod at the control horn to achieve the following measurements when moving the sticks to their endpoints.

### Elevator High Rate (100%) (20% Exponential)

Up	19/32-inch (15mm)	23 degrees
Down	23/32-inch (18mm)	25 degrees

### Elevator Low Rate (15% Exponential)

Up	11/32-inch (8.5mm)	13 degrees
Down	13/32-inch (10.5mm)	15 degrees

### Aileron High Rate (100%) (20% Exponential)

Up	17/32-inch (13.5mm)	25 degrees
Down	17/32-inch (13.5mm)	25 degrees

### Aileron Low Rate (15% Exponential)

Up	13/32-inch (10.5mm)	19 degrees
Down	13/32-inch (10.5mm)	19 degrees

### **Rudder High Rate (100%) (20% Exponential)**

Right	2 <sup>7</sup> / <sub>8</sub> -inch	(73mm)	35 degrees
Left	2 <sup>7</sup> / <sub>8</sub> -inch	(73mm)	35 degrees

### **Rudder Low Rate (15% Exponential)**

Right	2 <sup>1</sup> / <sub>4</sub> -inch	(57mm)	25 degrees
Left	2 <sup>1</sup> / <sub>4</sub> -inch	(57mm)	25 degrees

## ***E-tips***

Measurements are taken at the inner or widest point on the control surface.

These are general guidelines measured from our own flight tests. You can experiment with higher rates to match your preferred style of flying.

## ***E-tips***

Travel Adjust and Sub-Trims are not listed and should be adjusted according to each individual model and preference.

## ***E-tips***

We highly recommend re-binding the radio system once all the control throws are set. This will keep the servos from moving to their endpoints until the transmitter and receiver connect.

## **Preflight**

### **Check Your Radio**

Before going to the field, be sure your batteries are fully charged per the instructions included with your radio. Charge the transmitter and motor battery for your airplane. Use the recommended charger supplied with your particular radio system, following the instructions provided with the radio. In most cases, the radio should be charged the night before going out flying.

Before each flying session, be sure to range check your radio. See your radio manual for the recommended range and instructions for your radio system. Each radio manufacturer specifies different procedures for their radio systems. Next, run the motor. With the model securely anchored, check the range again. The range test should not be significantly affected. If it is, don't attempt to fly! Have your radio equipment checked out by the manufacturer.

Double-check that all controls (aileron, elevator, rudder and throttle) move in the correct direction.

Check the radio installation and make sure all the control surfaces are moving correctly (i.e., the correct direction and with the recommended throws).

Check all the control horns, servo horns, and clevises to make sure they are secure and in good condition.

## **Flying Your Advance 25e ARF**

The Advance 25e is a very spirited flyer yet is gentle and forgiving during takeoff and landing.

Ground handling is easy due to the tricycle landing gear. When on the runway, set the throttle trim to so the motor is spinning low RPM. Then smoothly apply power and apply a small amount of up elevator during your takeoff roll. Make small corrections with the rudder to keep the airplane tracking straight down the runway. The Advance will lift off of the ground gently and smoothly and settle into a gentle climb angle. Once at altitude, trim the airplane at a cruise power setting of 1/2 to 3/4 throttle. After trimming and making a few passes, try some slow speed flight at altitude. The airplane is very stable at low airspeeds and during a stall; it will break very gently straight ahead.

The Advance is easily capable of aerobatics such as loops, rolls, spins, inverted flight and even knife edge. Combine these to create an endless amount of aerobatic maneuvers.

When setting up to land, reduce power and begin to bleed off airspeed. Fly a traffic pattern and continue to lose altitude. Line up to the runway on final approach and allow the Advance to continue to descend. When a few feet above the runway, begin to flare with up elevator. Once the airplane settles into ground effect, it will set down gently at a slightly nose-high attitude. If the nose is kept high on roll out, the airplane will bleed off speed much quicker. Use small corrections to keep the airplane tracking straight down the runway.

Congratulations, you have just successfully flown your Advance 25e! We hope you have many more enjoyable flights with this model.

Happy Landings!

## Range Test Your Radio

Before each flying session, and especially with a new model, it is important to perform a range check. It is helpful to have another person available to assist during the range check. If you are using a Spektrum transmitter, please refer to your transmitter's manual for detailed instructions on the range check process.

- 1. With the model resting on the ground, stand 30 paces (approximately 90 feet) away from the model.
- 2. Face the model with the transmitter in your normal flying position. Be sure the throttle is in the full down position and plug the flight battery into the speed control.
- 3. As you move the controls, watch to be sure the airplane's motor and controls operate smoothly. You should have total control of the model at 30 paces (90 feet).
- 4. If control issues exist, call the appropriate Horizon Product Support office (see page 43) or go to [horizonhobby.com](http://horizonhobby.com) to find a local Spektrum distributor in your country for service if using a Spektrum radio system.

## Daily Flight Checks

- 1. Check the battery voltage of the transmitter battery. Do not fly below the manufacturer's recommended voltage. To do so can crash your aircraft.

### ***E-tips***

When you check these batteries, ensure you have the polarities correct on your expanded scale voltmeter.

- 2. Check all hardware (linkages, screws, nuts, and bolts) prior to each day's flight. Be sure that binding does not occur and that all parts are properly secured.
- 3. Ensure all surfaces are moving in the proper manner.
- 4. Perform a ground range check before each flying session.
- 5. Prior to starting your aircraft, turn off your transmitter, then turn it back on. Do this each time you start your aircraft. If any critical switches are on without your knowledge, the transmitter alarm will sound a warning at this time.
- 6. Check that all trim levers are in the proper location.
- 7. All servo pigtails and switch harness plugs should be secured in the receiver. Make sure the switch harness moves freely in both directions.

## Warranty and Repair Policy

### WARRANTY PERIOD

Exclusive Warranty- Horizon Hobby, Inc., (Horizon) warranties that the Products purchased (the "Product") will be free from defects in materials and workmanship at the date of purchase by the Purchaser.

### LIMITED WARRANTY

***Horizon reserves the right to change or modify this warranty without notice and disclaims all other warranties, express or implied.***

(a) This warranty is limited to the original Purchaser ("Purchaser") and is not transferable. REPAIR OR REPLACEMENT AS PROVIDED UNDER THIS WARRANTY IS THE EXCLUSIVE REMEDY OF THE PURCHASER. This warranty covers only those Products purchased from an authorized Horizon dealer. Third party transactions are not covered by this warranty. Proof of purchase is required for all warranty claims.

(b) Limitations- HORIZON MAKES NO WARRANTY OR REPRESENTATION, EXPRESS OR IMPLIED, ABOUT NON-INFRINGEMENT, MERCHANTABILITY OR FITNESS FOR A PARTICULAR PURPOSE OF THE PRODUCT. THE PURCHASER ACKNOWLEDGES THAT THEY ALONE HAVE DETERMINED THAT THE PRODUCT WILL SUITABLY MEET THE REQUIREMENTS OF THE PURCHASER'S INTENDED USE.

(c) Purchaser Remedy- Horizon's sole obligation hereunder shall be that Horizon will, at its option, (i) repair or (ii) replace, any Product determined by Horizon to be defective. In the event of a defect, these are the Purchaser's exclusive remedies. Horizon reserves the right to inspect any and all equipment involved in a warranty claim. Repair or replacement decisions are at the sole discretion of Horizon. This warranty does not cover cosmetic damage or damage due to acts of God, accident, misuse, abuse, negligence, commercial use, or modification of or to any part of the Product. This warranty does not cover damage due to improper installation, operation, maintenance, or attempted repair by anyone other than Horizon. Return of any Product by Purchaser must be approved in writing by Horizon before shipment.



## DAMAGE LIMITS

---

HORIZON SHALL NOT BE LIABLE FOR SPECIAL, INDIRECT OR CONSEQUENTIAL DAMAGES, LOSS OF PROFITS OR PRODUCTION OR COMMERCIAL LOSS IN ANY WAY CONNECTED WITH THE PRODUCT, WHETHER SUCH CLAIM IS BASED IN CONTRACT, WARRANTY, NEGLIGENCE, OR STRICT LIABILITY. Further, in no event shall the liability of Horizon exceed the individual price of the Product on which liability is asserted. As Horizon has no control over use, setup, final assembly, modification or misuse, no liability shall be assumed nor accepted for any resulting damage or injury. By the act of use, setup or assembly, the user accepts all resulting liability.

If you as the Purchaser or user are not prepared to accept the liability associated with the use of this Product, you are advised to return this Product immediately in new and unused condition to the place of purchase.

Law: These Terms are governed by Illinois law (without regard to conflict of law principals).

## Warranty Services

---

### QUESTIONS, ASSISTANCE, AND REPAIRS

---

Your local hobby store and/or place of purchase cannot provide warranty support or repair. Once assembly, setup or use of the Product has been started, you must contact Horizon directly. This will enable Horizon to better answer your questions and service you in the event that you may need any assistance. For questions or assistance, please direct your email to [productsupport@horizonhobby.com](mailto:productsupport@horizonhobby.com), or call 877.504.0233 toll free to speak to a Product Support representative. You may also find information on our website at [www.horizonhobby.com](http://www.horizonhobby.com).

### INSPECTION OR REPAIRS

---

If this Product needs to be inspected or repaired, please use the Horizon Online Repair Request submission process found on our website or call Horizon to obtain a Return Merchandise Authorization (RMA) number. Pack the Product securely using a shipping carton. Please note that original boxes may be included, but are not designed to withstand the rigors of shipping without additional protection. Ship via a carrier that provides tracking and insurance for lost or damaged parcels, as Horizon is not responsible for merchandise until it arrives and is accepted at our facility. An Online Repair Request is available at [www.horizonhobby.com](http://www.horizonhobby.com) <http://www.horizonhobby.com> under the Repairs tab. If you do not have internet access, please contact Horizon Product Support to obtain a RMA number along with instructions for submitting your product for repair. When calling Horizon, you will be asked to provide your complete name, street address, email address and phone number where you can be reached during business hours. When sending product into Horizon, please include your RMA number, a list of the included items, and a brief summary of the problem. A copy of your original sales receipt must be included for warranty consideration. Be sure your name, address, and RMA number are clearly written on the outside of the shipping carton.

**Notice: Do not ship batteries to Horizon. If you have any issue with a battery, please contact the appropriate Horizon Product Support office.**

## WARRANTY INSPECTION AND REPAIRS

---

**To receive warranty service, you must include your original sales receipt** verifying the proof-of-purchase date. Provided warranty conditions have been met, your Product will be repaired or replaced free of charge. Repair or replacement decisions are at the sole discretion of Horizon.

### NON-WARRANTY REPAIRS

---

**Should your repair not be covered by warranty the repair will be completed and payment will be required without notification or estimate of the expense unless the expense exceeds 50% of the retail purchase cost.** By submitting the item for repair you are agreeing to payment of the repair without notification. Repair estimates are available upon request. You must include this request with your repair. Non-warranty repair estimates will be billed a minimum of ½ hour of labor. In addition you will be billed for return freight. Horizon accepts money orders and cashiers checks, as well as Visa, MasterCard, American Express, and Discover cards. By submitting any item to Horizon for inspection or repair, you are agreeing to Horizon's Terms and Conditions found on our website under the Repairs tab.

### UNITED STATES

---

*(Electronics and engines)*  
Horizon Service Center  
4105 Fieldstone Rd  
Champaign, Illinois  
61822 USA  
877-504-0233

Online Repair Request visit:  
[www.horizonhobby.com/repairs](http://www.horizonhobby.com/repairs)

*(All other products)*  
Horizon Product Support  
4105 Fieldstone Rd  
Champaign, Illinois  
61822 USA  
[productsupport@horizonhobby.com](mailto:productsupport@horizonhobby.com)  
877-504-0233

## UNITED KINGDOM

Horizon Hobby Limited  
Units 1-4 Ployters Rd  
Staple Tye  
Harlow, Essex  
CM18 7NS  
United Kingdom  
sales@horizonhobby.co.uk  
+44 (0) 1279 641 097

## GERMANY

Horizon Technischer Service  
Hamburger Str. 10  
25335 Elmshorn  
Germany  
service@horizonhobby.de  
+49 4121 46199 66

## FRANCE

Horizon Hobby SAS  
14 Rue Gustave Eiffel  
Zone d'Activité du Réveil Matin  
91230 Montgeron  
infofrance@horizonhobby.com  
+33 (0) 1 60 47 44 70

## Compliance Information for the European Union



### INSTRUCTIONS FOR DISPOSAL OF WEEE BY USERS IN THE EUROPEAN UNION

This product must not be disposed of with other waste. Instead, it is the user's responsibility to dispose of their waste equipment by handing it over to a designated collection point for the recycling of waste electrical and electronic equipment. The separate collection and recycling of your waste equipment at the time of disposal will help to conserve natural resources and ensure that it is recycled in a manner that protects human health and the environment. For more information about where you can drop off your waste equipment for recycling, please contact your local city office, your household waste disposal service or where you purchased the product.

## 2010 Official Academy of Model Aeronautics Safety Code

### GENERAL

1. A model aircraft shall be defined as a non-human-carrying device capable of sustained flight in the atmosphere. It shall not exceed limitations established in this code and is intended to be used exclusively for recreational or competition activity.
2. The maximum takeoff weight of a model aircraft, including fuel, is 55 pounds, except for those flown under the AMA Experimental Aircraft Rules.
3. I will abide by this Safety Code and all rules established for the flying site I use. I will not willfully fly my model aircraft in a reckless and/or dangerous manner.
4. I will not fly my model aircraft in sanctioned events, air shows, or model demonstrations until it has been proven airworthy.
5. I will not fly my model aircraft higher than approximately 400 feet above ground level, when within three (3) miles of an airport without notifying the airport operator. I will yield the right-of-way and avoid flying in the proximity of full-scale aircraft, utilizing a spotter when appropriate.
6. I will not fly my model aircraft unless it is identified with my name and address, or AMA number, inside or affixed to the outside of the model aircraft. This does not apply to model aircraft flown indoors.
7. I will not operate model aircraft with metal-blade propellers or with gaseous boosts (other than air), nor will I operate model aircraft with fuels containing tetranitromethane or hydrazine.

8. I will not operate model aircraft carrying pyrotechnic devices which explode, burn, or propel a projectile of any kind. Exceptions include Free Flight fuses or devices that burn producing smoke and are securely attached to the model aircraft during flight. Rocket motors up to a G-series size may be used, provided they remain firmly attached to the model aircraft during flight. Model rockets may be flown in accordance with the National Model Rocketry Safety Code; however, they may not be launched from model aircraft. Officially designated AMA Air Show Teams (AST) are authorized to use devices and practices as defined within the Air Show Advisory Committee Document.
9. I will not operate my model aircraft while under the influence of alcohol or within eight (8) hours of having consumed alcohol.
10. I will not operate my model aircraft while using any drug which could adversely affect my ability to safely control my model aircraft.
11. Children under six (6) years old are only allowed on a flightline or in a flight area as a pilot or while under flight instruction.
12. When and where required by rule, helmets must be properly worn and fastened. They must be OSHA, DOT, ANSI, SNELL or NOCSAE approved or comply with comparable standards.

### RADIO CONTROL

1. All model flying shall be conducted in a manner to avoid over flight of unprotected people.
2. I will have completed a successful radio equipment ground-range check before the first flight of a new or repaired model aircraft.

3. I will not fly my model aircraft in the presence of spectators until I become a proficient flier, unless I am assisted by an experienced pilot.
4. At all flying sites a line must be established, in front of which all flying takes place. Only personnel associated with flying the model aircraft are allowed at or in front of the line. In the case of airshows demonstrations straight line must be established. An area away from the line must be maintained for spectators. Intentional flying behind the line is prohibited.
5. I will operate my model aircraft using only radio-control frequencies currently allowed by the Federal Communications Commission (FCC). Only individuals properly licensed by the FCC are authorized to operate equipment on Amateur Band frequencies.
6. I will not knowingly operate my model aircraft within three (3) miles of any preexisting flying site without a frequency-management agreement. A frequency management agreement may be an allocation of frequencies for each site, a day-use agreement between sites, or testing which determines that no interference exists. A frequency-management agreement may exist between two or more AMA chartered clubs, AMA clubs and individual AMA members, or individual AMA members. Frequency-management agreements, including an interference test report if the agreement indicates no interference exists, will be signed by all parties and copies provided to AMA Headquarters.
7. With the exception of events flown under official AMA rules, no powered model may be flown outdoors closer than 25 feet to any individual, except for the pilot and located at the flightline.
8. Under no circumstances may a pilot or other person touch a model aircraft in flight while it is still under power, except to divert it from striking an individual.
9. Radio-controlled night flying is limited to low-performance model aircraft (less than 100 mph). The model aircraft must be equipped with a lighting system which clearly defines the aircraft's attitude and direction at all times.
10. The operator of a radio-controlled model aircraft shall control it during the entire flight, maintaining visual contact without enhancement other than by corrective lenses that are prescribed for the pilot. No model aircraft shall be equipped with devices which allow it to be flown to a selected location which is beyond the visual range of the pilot.

**Advance 25e**

**Safe Operating Recommendations**

- Inspect your model before every flight to make certain it is airworthy.
- Be aware of any other radio frequency user who may present an interference problem.
- Always be courteous and respectful of other users of your selected flight area.
- Choose an area clear of obstacles and large enough to safely accommodate your flying activity.
- Make certain this area is clear of friends and spectators prior to launching your aircraft.
- Be aware of other activities in the vicinity of your flight path that could cause potential conflict.
- Carefully plan your flight path prior to launch.
- Abide by any and all established AMA National Model Aircraft Safety Code.



© 2010 Horizon Hobby, Inc.  
[horizonhobby.com](http://horizonhobby.com)  
[www.e-fliterc.com](http://www.e-fliterc.com)

*The Spektrum trademark is used with permission of Bachmann Industries, Inc.*

*E-flite, JR SPORT, DSM, DSM2 and UltraCote are trademarks or registered trademarks of Horizon Hobby, Inc.*

*All other trademarks, service marks and logos are the property of their respective owners.*