

P-47 Thunderbolt



E-fliteTM

Assembly Manual

Table of Contents

Table of Contents	2
Specifications	2
Contents of Kit/Parts Layout	3
Required Radio Equipment	4
Required Power System Equipment	4
Required Tools and Adhesives	5
Optional High Power Inrunner Brushless Motor Power System Required Equipment*	6
Optional Sport Outrunner Brushless Motor Power System Required Equipment*	6
Optional High Power Outrunner Brushless Motor Power System Required Equipment	7
Optional Accessories	7
Using the Manual	8
Warning	8
Before Starting Assembly	8
Note on Lithium Polymer Batteries	8

Warranty Information	9
Wing Preparation	10
Wing Installation	14
Stabilizer Installation	15
Optional Rudder	19
Radio Installation	22
Stock Motor Installation	27
Inrunner Motor Installation Park 400	30
Outrunner Motor Installation	35
Final Assembly	39
Control Throws	41
Range Testing the Radio	42
Preflight	42
Notes	44
2005 Official AMA National Model Aircraft Safety Code	46

Specifications

Wingspan:	39" (990mm)
Length:	32" (813mm)
Wing Area:	260 sq in (16.8 sq dm)
Weight w/o Battery:	18–21 oz (510–595 g)
Weight w/ Battery:	21–26 oz (595–737 g)

Contents of Kit/Parts Layout

Large Replacement Parts:

EFL6001	Wing
EFL6002	Fuselage
EFL6003	Hatch
EFL6004	Cowl
EFL6005	Horizontal Tail

Small Replacement Parts

EFL6006	Hardware and Pushrod Set
EFL6007	Landing Gear Set
EFL6008	Bomb and Pylon Set
EFL6009	Decal Set
EFLM232	480 Motor w/19T 0.5 Module Pinion
EFLM236	400 Gearbox, w/56T 0.5M Spur Gear
EFLM237	Spur Gear, 56T 0.5 Module with Shaft
EFLM238	Spur Gear, 56T 0.5 Module
EFLM1915	Outrunner Stick Mount
EFLP1080E	10x8 Electric Prop



Required Radio Equipment

You will need a 3-channel or greater radio transmitter and micro receiver (at least 4-channel with optional rudder). You can choose from the equipment below including a complete radio system or separate receiver, crystal and servos when using your existing radio equipment.

JSP14010**	JR Sport 4-Channel System MD2 UL —Complete radio system (Includes 2 servos)
or	
JSP30610	6CH UL FM Receiver w/o crystal, Positive Shift (JR/AIRZ)
or	
JSP30615	6CH UL FM Receiver w/o crystal, Negative Shift (HRC/FUT)
JRPXFR**	FM Receiver Crystal
EFLRS75	7.5-Gram Sub-Micro Servo (3 or 4 w/ optional rudder)
JSP98020	Y-Harness, Standard 6"

Required Power System Equipment

For stock brushed power system only. Please see optional brushless power system required equipment when choosing brushless power system alternatives.

CSEP20P	Pixie-20P Sub Micro ESC
EFLA239	Female Bullet Plug w/Lead
THP21003SPL	2100mAh 3-Cell 11.1V Li-Po, 16GA
EFLC3005	Celectra 1-3 Cell Li-Po Charger
WSD1300	Ultra Plug, Male/Female Set (2)

Substituting the 3-Cell Li-Po pack and charger with a 9-Cell Ni-MH pack and charger offers slightly reduced performance and duration but provides a good power pack alternative:

PKZ1027	10.8V 1000mAh Ni-MH Battery
PKZ1519	5–10 Cell DC Peak Charger

Required Tools and Adhesives

Tools & Equipment

EFLA257	Screwdriver, #0 Phillips (Or included with EFLA250)
EFLA258	Screwdriver, #1 Phillips (Or included with EFLA250)
EFLA250	Park Flyer Tool Assortment, 5pc

Hobby knife

Drill

Drill bit: .050", 5/32"

Straight edge

Felt tipped pen

Razor saw

Sandpaper

Adhesives

EFLA206	Foam Compatible Thick CA (Or included with EFLA208)
EFLA207	Foam Compatible Activator (Or included with EFLA208)
EFLA208	Foam CA/Activator Pack
EFLA209	Foam Compatible Medium CA

Low-temperature hot glue

Optional High Power Inrunner Brushless Motor Power System Required Equipment*

This is the most powerful optional power system well suited for large field flying and “full house” airframe configurations (i.e. – landing gear, rudder, etc. installed). Use with the included gearbox and optional 6.5:1 gear ratio.

EFLM1100	Park 400 Inrunner Brushless, 4200Kv
EFLM1912	Heat Sink, 20mm x 20mm Park 400 Inrunner
EFLA311B	20-Amp Brushless ESC (V2)
EFLM243	Spur Gear, 65T 0.5 Module
EFLM1951	Pinion Gear, 10T 0.5 Module 2mm I.D.
EFLP1170	11x7 Slow Flyer Propeller (2)
THP21003SPL	2100mAh 3-Cell 11.1V Li-Po, 16GA
EFLC3005	Celectra 1-3 Cell Li-Po Charger
WSD1300	Ultra Plug, Male/Female Set (2)

*Proper throttle management is required when using high performance setups.

Optional Sport Outrunner Brushless Motor Power System Required Equipment*

This powerful optional power system is well suited for small field flying and “lightweight” airframe configurations (i.e. – no landing gear, no rudder, etc installed). Use with the included 10x8E prop and outrunner stick mount.

EFLM1305	Park 400 Outrunner Brushless, 920Kv
EFLA311B	20-Amp Brushless ESC (V2)
THP21003SPL	2100mAh 3-Cell 11.1V Li-Po, 16GA
EFLC3005	Celectra 1-3 Cell Li-Po Charger
WSD1300	Ultra Plug, Male/Female Set (2)

*Proper throttle management is required when using high performance setups.

Optional High Power Outrunner Brushless Motor Power System Required Equipment

This powerful optional power system is well suited for large field flying and “full house” airframe configurations (i.e. - landing gear, rudder, etc. installed). Use with the included 10x8E prop and outrunner stick mount.

EFLM1400	Park 450 Outrunner Brushless, 890Kv
EFLA311B	20-Amp Brushless ESC (V2)
THP21003SPL	2100mAh 3-Cell 11.1V Li-Po, 16GA
EFLC3005	Celectra 1-3 Cell Li-Po Charger
WSD1300	Ultra Plug, Male/Female Set (2)

Substituting the 3-Cell Li-Po pack and charger with a 9-Cell Ni-MH pack and charger offers slightly reduced performance and duration but provides a good power pack alternative:

PKZ1027	10.8V 1000mAh Ni-MH Battery
PKZ1519	5–10 Cell DC Peak Charger

*Proper throttle management is required when using high performance setups.

Optional Accessories

EFLA110	Power Meter
EFLA212	Gear Puller: 1mm–5mm Shaft

Using the Manual

This manual is divided into sections to help make assembly easier to understand, and to provide breaks between each major section.

Remember to take your time and follow the directions.

Warning

An RC aircraft is not a toy! If misused, it can cause serious bodily harm and damage to property. Fly only in open areas, preferably at AMA (Academy of Model Aeronautics) approved flying sites, following all instructions included with your radio.

Keep loose items that can get entangled in the propeller away from the prop, included loose clothing, or other objects such as pencils and screwdrivers. Especially keep your hands away from the propeller.

Before Starting Assembly

Before beginning the assembly of your P-47D Thunderbolt, remove each part from its bag for inspection. Closely inspect the fuselage, hatch, wing and stabilizer for damage. If you find any damaged or missing parts, contact the place of purchase.

Note on Lithium Polymer Batteries



Lithium Polymer batteries are significantly more volatile than alkaline or Ni-Cd/ Ni-MH batteries used in RC applications. All manufacturer's instructions and warnings must be followed closely. Mishandling of Li-Po batteries can result in fire. Always follow the manufacturer's instructions when disposing of Lithium Polymer batteries.

Warranty Information

Horizon Hobby, Inc. guarantees this kit to be free from defects in both material and workmanship at the date of purchase. This warranty does not cover any component parts damage by use or modification. In no case shall Horizon Hobby's liability exceed the original cost of the purchased kit. Further, Horizon Hobby reserves the right to change or modify this warranty without notice.

In that Horizon Hobby has no control over the final assembly or material used for the final assembly, no liability shall be assumed nor accepted for any damage resulting from the use of the final assembled product. By the act of using the assembled product, the user accepts all resulting liability.

Please note that once assembly of the model has been started, you must contact Horizon Hobby, Inc. directly regarding any warranty question. Please do not contact your local hobby shop regarding warranty issues, even if that is where you purchased it. This will enable Horizon to better answer your questions and service you in the event that you may need any assistance.

If the buyer is not prepared to accept the liability associated with the use of this product, the buyer is advised to return this kit immediately in new and unused condition to the place of purchase.

Horizon Hobby, Inc.
4105 Fieldstone Road
Champaign, Illinois 61822
877-504-0233
horizonhobby.com

Wing Preparation

Required Parts

- Wing
- Y-Harness
- Landing gear screws (4)
- 18mm x 20mm two-sided tape (2)
- Servo (2)
- Aileron pushrod (2)

Required Tools and Adhesives

- Drill
 - Hobby knife
 - Low-temperature hot glue
 - Phillips screwdriver (small)
 - Drill bit: .050"
- 1. Use the radio system to electronically center the aileron servos. Attach a control horn to each of the servos.



- 2. Apply the 18mm x 20mm two-sided tape to the servos. Test fit the servos into the wing. The servo arm faces to the leading edge. After fitting, remove the backing from the tape to secure the servos into the wing.

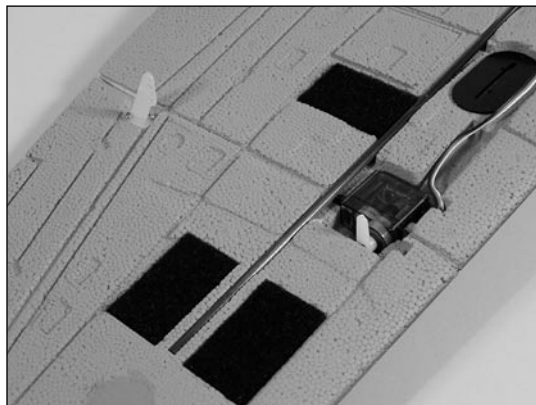

- 3. Attach the Y-Harness to both servos. Route the single lead of the Y-Harness through the hole in the center of the wing.

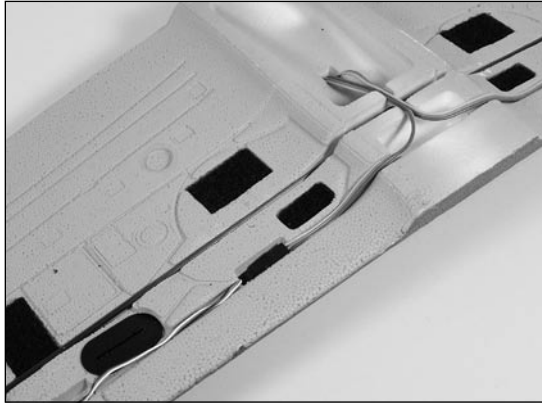

Hint: Use tape to secure the servo leads to the Y-Harness so they won't accidentally unplug.

Note: If using a radio with the appropriate mixing capability, two 12" servo extensions can be used instead of the Y-Harness for the aileron servos.

Note: The landing gear is optional and can be left off when flying from rough surfaces or tall grass that could damage the gear. Skip to Step 6 if the landing gear will not be installed.

- 4. Attach the main landing gear using four landing gear mounting screws (2mm x 6mm).

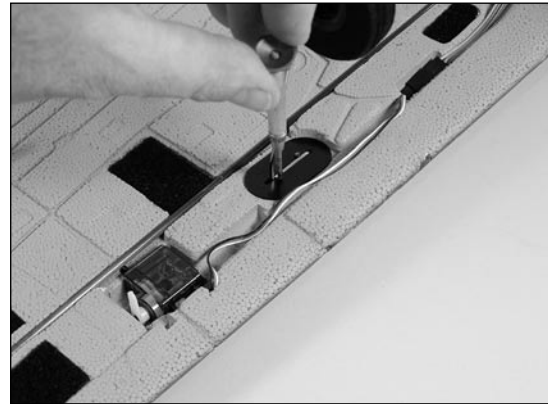

- 5. Attach the tail wheel using two landing gear mounting screws (2mm x 6mm).

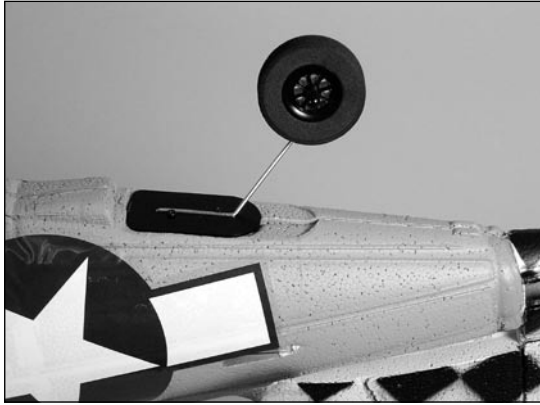

- 6. Test fit the wing covers. Trim around the landing gear and servo arm as necessary. Remove the backing from the two-sided tape on the covers. Carefully place the wing covers into position, pressing them against the wing to secure them.

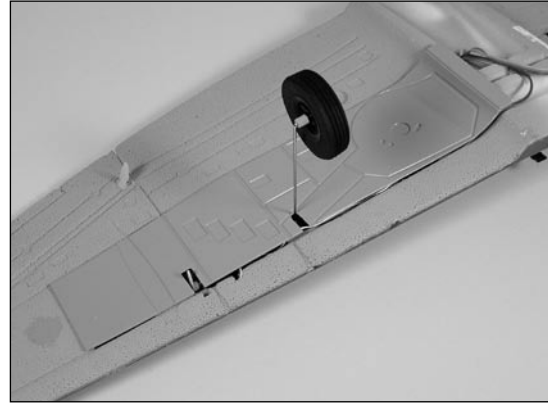

Hint: Use clear tape to keep the servo lead and extension in the channel in the wing.

- 7. Attach the "Z" bend of the pushrod to the aileron servo arm. Use a hobby knife or .050" drill bit to ream out the servo arm if necessary to fit the pushrod.

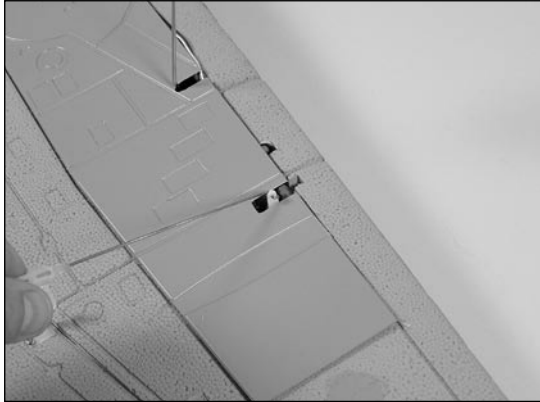

- 8. Turn the radio system on and plug the Y-Harness lead into the receiver. Snap the clevis onto the control horn. Thread the clevis either in or out so the aileron is centered when the servo is centered.



Wing Installation

Required Parts

- Wing
- Belly pan
- Fuselage

Required Tools and Adhesives

- Phillips screwdriver

- 1. Place the wing onto the fuselage. Make sure to pass the Y-Harness lead through the opening in the fuselage.



- 2. Place the belly pan onto the wing and fuselage. The mounting plate at the rear of the belly pan keys into the fuselage mounting plate. Use the screw at the front to secure the belly pan and wing to the fuselage.

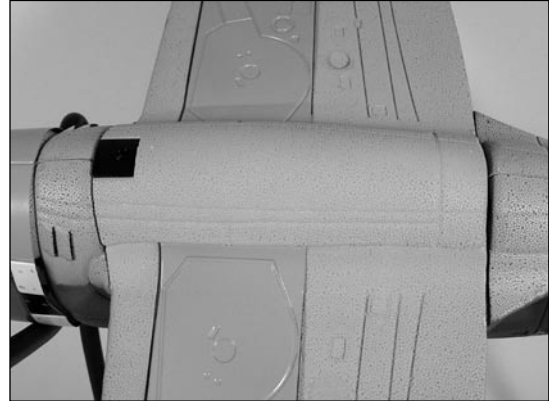

Stabilizer Installation

Required Parts

- Fuselage assembly
- Stabilizer w/elevators and hinges

Required tools and Adhesives

- Sandpaper
- Hobby knife
- Foam-safe CA

- 1. Carefully remove any flashing from the opening in the fuselage for the stabilizer.

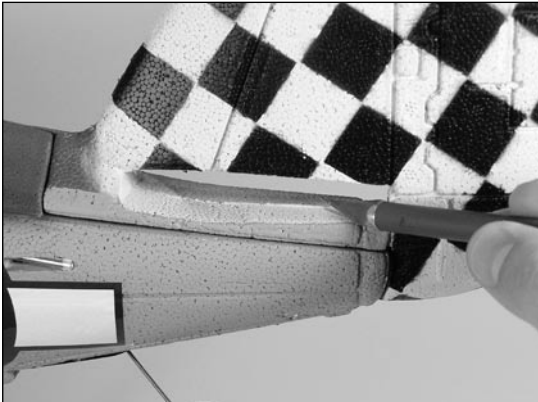

- 2. Remove the elevators and joiner wire with bushings from the stabilizer. Slide the stabilizer into the fuselage.



Note: You may need to sand the fuselage opening slightly for proper fit of the stabilizer.

- 3. Check the alignment of the stabilizer to the wing. When viewed from the rear it must be level to the wing. Sanding the opening in the fuse can correct any misalignments.

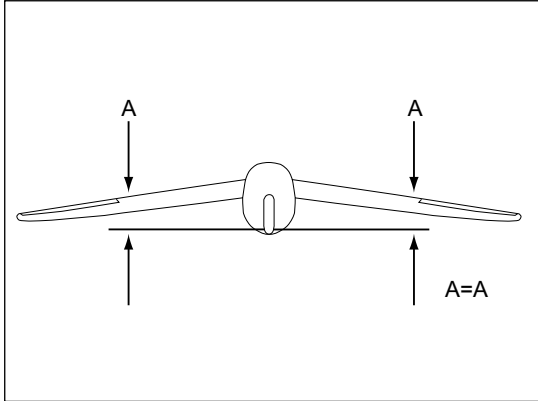

- 4. Check the distance between each stabilizer tip and each wing tip. Move the stabilizer as necessary for alignment, making both distances equal. Also make sure the stabilizer is centered with equal amounts of the stabilizer on each side of the fuselage. Once you have confirmed proper alignment, use a felt tip marker to mark the stabilizer where it lines up with the fuse. It is best to mark the bottom of the stabilizer only as you will not be able to remove marker without causing damage to the paint finish.

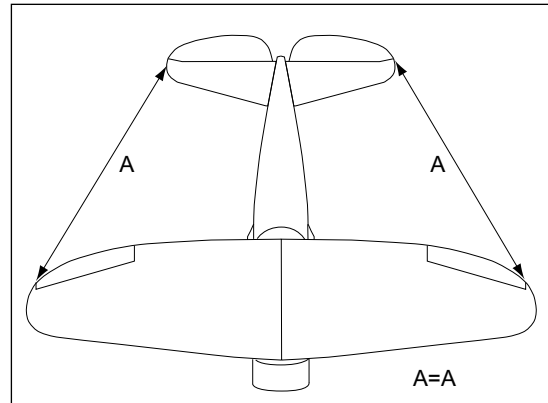

- 5. Remove the stabilizer and cut a notch in the rudder to allow for the elevator joiner wire.

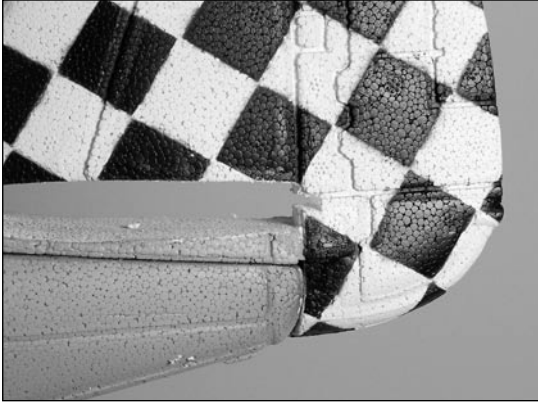

- 6. Place the joiner wire into the notch cut in the last step. Slide the stabilizer back into position. Check the alignment of the stabilizer, and then use foam safe CA to glue the stabilizer to the fuselage.



- 7. Glue the joiner wire and hinges using foam-safe CA.



Optional Rudder

Note: Your P-47D Thunderbolt has an option to make the rudder functional. This section covers the required steps for this option. You can skip this section if you do not want to use the optional rudder.

Required Parts

- Hinge (3)
- Fuselage assembly
- Control horn backplate
- Control horn
- Control horn screw (2)

Required tools and Adhesives

- Sandpaper
- Straight edge
- Felt-tipped pen
- Hobby knife
- Foam-safe CA

- 1. Use a sharp hobby knife to carefully cut the rudder from the fuselage. Use sandpaper to clean up the cut on the fuselage.

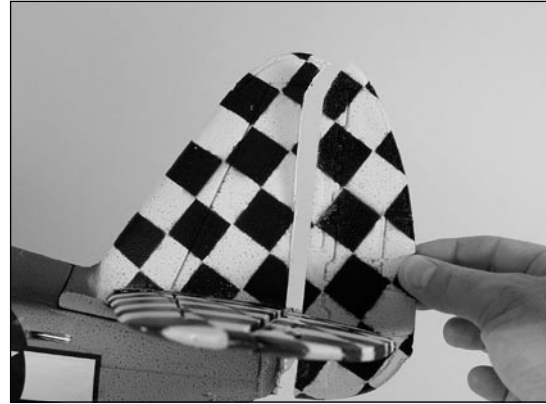

- 2. Use a straight edge to draw a centerline on the front edge of the rudder.

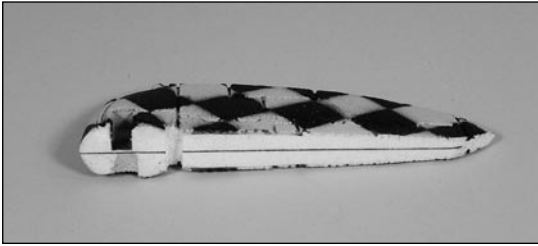

- 3. Sand a bevel on the rudder back from the centerline as shown.



- 4. Cut slots for the three rudder hinges. The slots are near the top, near the bottom, and in the center. Use foam safe CA to install the hinges into the rudder.

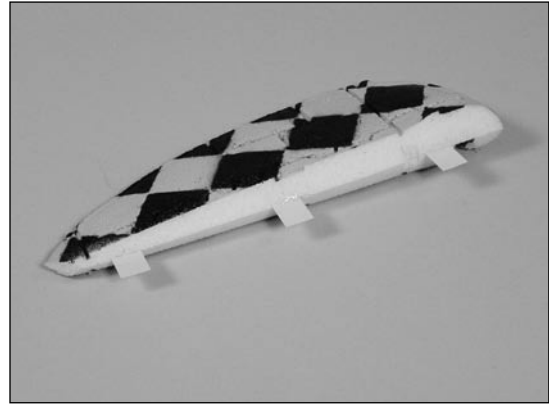

- 5. Install the control horn using the control horn backplate and the two control horn screws.

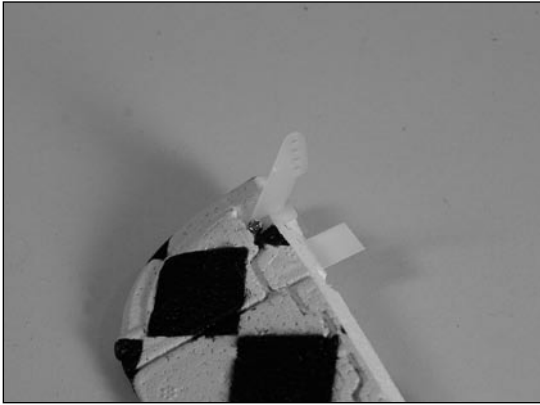

- 6. Cut three slots in the fin for the rudder hinges. Test the fit of the rudder to ensure the bevel and hinge gap allow for plenty of travel without binding. Once you have everything fit and moving freely, use foam-safe CA to glue the hinges to the fin and fuselage.



Radio Installation

Required Parts

- Receiver
- Servo (2)
- Clevis (2)
- Speed control
- Bullet connectors
- Fuselage assembly
- Rudder pushrod (13³/₄")
- Elevator pushrod (13¹/₈")

Required Tools and Adhesives

- Drill
- Drill bit: .050"
- Low-temperature hot glue
- Hook and loop material

Note: Ignore the items mentioning the rudder servo and pushrod if you have not installed the optional rudder.

- 1. Plug the rudder and elevator servos into the receiver. Use the radio system to center the servos. Attach servo arms to the rudder and elevator servos.

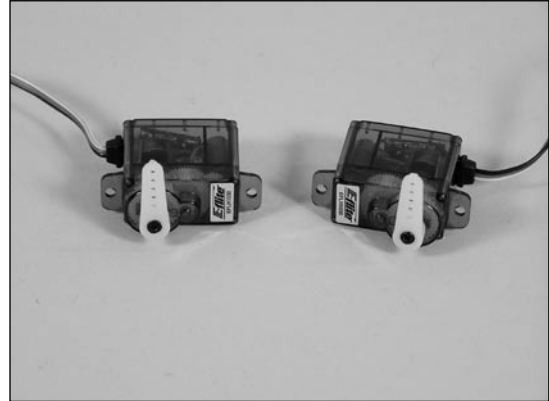

- 2. Attach the $13\frac{1}{8}$ " elevator pushrod to the servo to be used for the elevator. Slide the pushrod into one of the tubes in the fuselage and check that it exits the fuselage on the side of the elevator horn. If not, use the other tube.

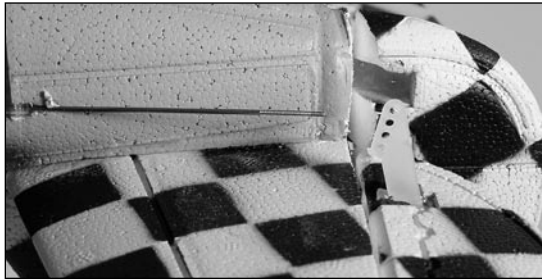

- 3. Test fit the elevator servo. Once fit, use low-temperature hot glue to secure the servo in the fuselage.

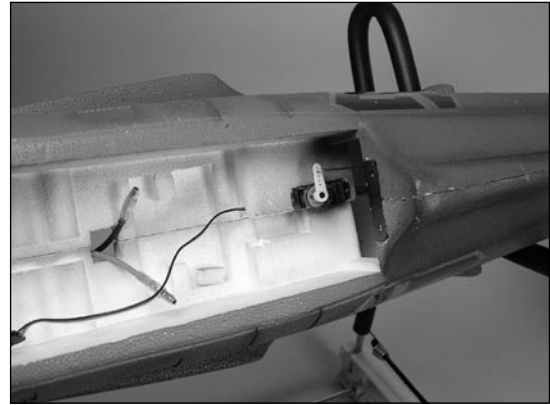

- 4. With the radio on, thread the clevis onto the elevator pushrod. Use a hobby knife or .050" drill bit to ream out the servo arm if necessary to fit the pushrod. Snap the clevis onto the elevator control horn. Check that the elevator is neutral. If not, thread the clevis in or out as necessary.



- 5. Repeat Steps 2 through 4 for the optional rudder servo. Use the 13 ³/₄" pushrod when installing the rudder pushrod.

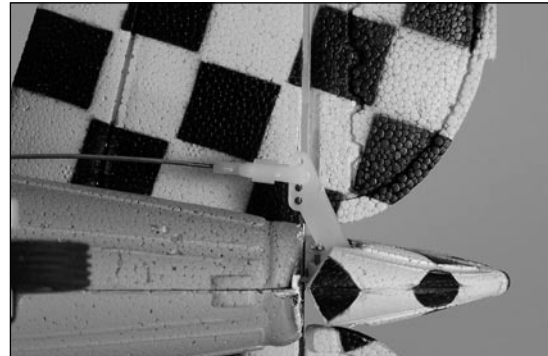
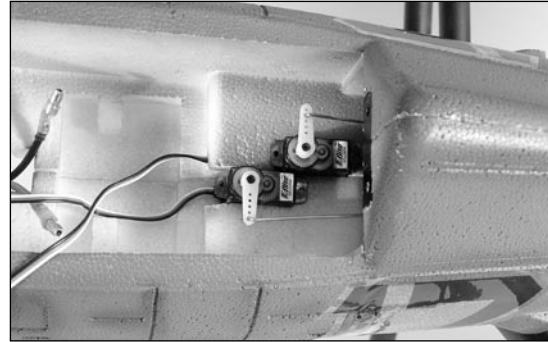

Note: A small bend may be required in the rudder pushrod after it exits the fuselage to prevent the pushrod from binding when attached to the control horn.

- 6. Use the included hook and loop material to attach the receiver in the fuselage. Route the antenna wire out of the fuselage and to the tail of your P-47D Thunderbolt.

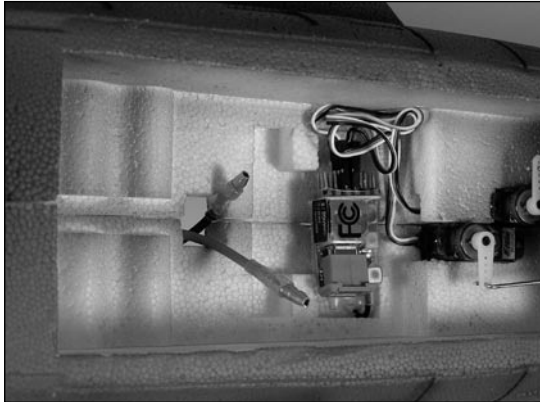

Note: Do not cut the antenna wire as it will greatly reduce the range of your radio system.

Be sure to route the antenna wire as far away from all electronic components and pushrods as possible. We suggest routing the antenna out the rear of the hatch or cooling air exits and attaching it to the top of the vertical fin.

- 7. Install the bullet connectors to the motor leads of your speed control. You can solder the speed control leads directly to the motor leads if you prefer. Connect the speed control to the receiver. Check that the motor rotates the correct direction when powered up. If not, reverse the motor leads. Use the included hook and loop material to secure the speed control in the fuselage.

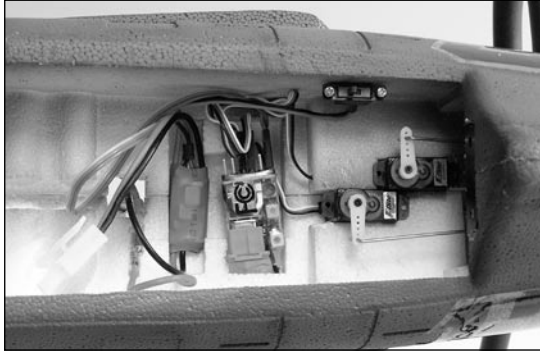

Note: Make sure the receiver and speed control are fitted into the recesses in the fuselage. If not, the cockpit on the canopy hatch will interfere with these and not fit correctly.

Stock Motor Installation

Required Parts

- Propeller
- Assembled airframe
- Motor and gearbox

Required Tools and Adhesives

- Wrench
- Foam-safe CA

Note: This section covers installing the stock gearbox and motor. Skip to the next section if you have opted to install the optional outrunner motor.

- 1. Check the motor stick to make sure it is secure in the fuselage. Apply foam-safe CA as necessary to make sure the motor stick is secure.



- 2. Slide the gearbox fully onto the motor stick.
Secure the gearbox using a 2mm x 10mm screw.

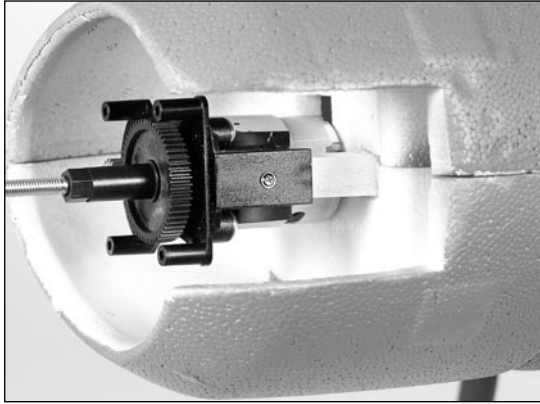

- 3. Remove the backing from the two-sided tape on the sides of the fuselage. Slide the cowling onto the fuselage, pressing it against the tape once you have confirmed proper alignment.



- 4. Attach the propeller using the lock nut and washer supplied. Tighten the lock nut only to hold the propeller on, as the hex will actually lock the motor shaft to the propeller. Do not over-tighten the lock nut.



- 5. Install the spinner onto the gearbox shaft by threading it into place.

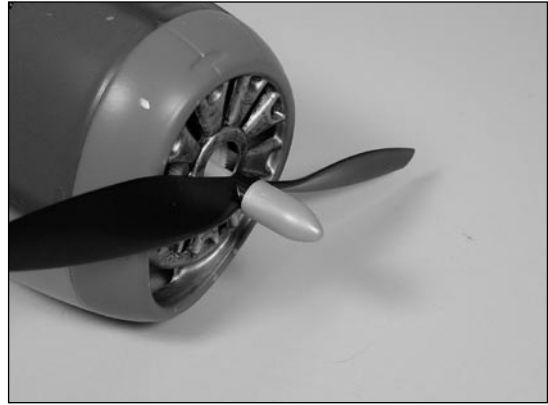

Inrunner Motor Installation Park 400

Required Parts

- 11x7 propeller
- Assembled airframe
- 10-tooth 0.5 module pinion gear
- 65-tooth 0.5 module spur gear

Required Tools and Adhesives

- Wrench
- Foam-safe CA
- Drill
- Drill bit: 5/32"

Note: This section covers installing the stock gearbox and optional Park 400 inrunner motor. Skip to the next section if you have opted to install the optional outrunner motor.

- 1. It may be necessary to attach motor adapters or other accessories to your particular motor at this time. Use the instructions provided with your motor to install any accessories.

- 2. Install the 10T 0.5 module pinion gear on your motor if you are using our included gearbox. Using any pinion gear other than the optional 10-tooth 0.5 module pinion gear (EFLM1951) will cause damage to the spur gear.
- 3. Remove the 56-tooth spur gear by sliding it off the shaft. Slide the optional 65-tooth 0.5 module spur gear (EFLM1243) onto the shaft.



Note: You will need to install the upper motor mounting screw with the spur gear removed.

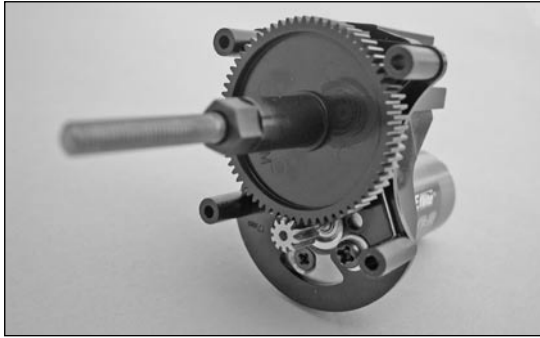

Note: When installing your motor into the gearbox, it is very important that your gear mesh is set correctly and the gear's mesh is smooth with no binding. This gearbox features multiple mounting holes so that you can ensure your gear mesh is correct depending on the motor and gear ratio you have chosen to use. Using the 18mm hole spacing will ensure the gear mesh can be set correctly when using the Park 400 motor and 6.5:1 gearing. Remember, if your mesh is too loose or too tight, it may strip the gears.

Proper gear mesh is extremely important for high power setups. Be certain to check the mesh at multiple points on the spur gear before finalizing the motor mounting position in the gearbox. To extend the life of your gearbox, we also recommend using a small amount of grease, such as lithium grease, on the spur gear.

We strongly recommend the use of our E-flite™ Park 400 Inrunner Brushless Motor. All product testing was conducted with this motor.



- 4. Check the motor stick to make sure it is secure in the fuselage. Apply foam-safe CA as necessary to make sure the motor stick is secure.



- 5. Slide the gearbox fully onto the motor stick. Secure the gearbox using a 2mm x 10mm screw.

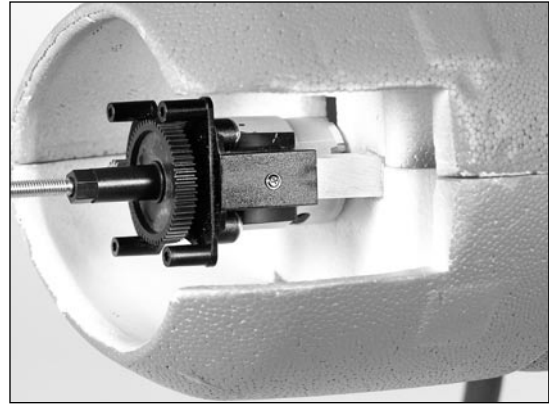

- 6. Remove the backing from the two-sided tape on the sides of the fuselage. Slide the cowling onto the fuselage, pressing it against the tape once you have confirmed proper alignment.



- 7. Install the large hex to small hex adapter then the 11 x 7 propeller.

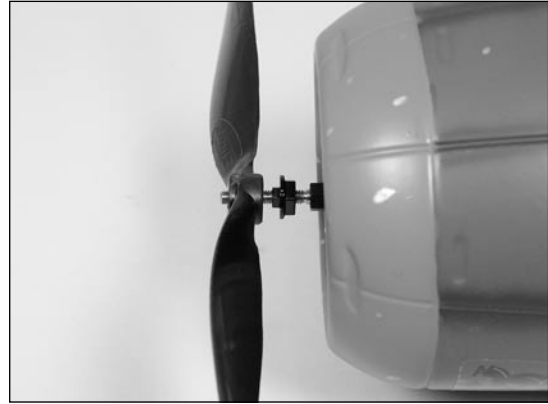

Note: The propeller will have to be drilled out using a 5/32" drill bit.

- 8. Secure the propeller using the lock nut and washer supplied. Tighten the lock nut only to hold the propeller on, as the hex will actually lock the motor shaft to the propeller. Do not over-tighten the lock nut.



- 9. Install the spinner onto the gearbox shaft by threading it into place.

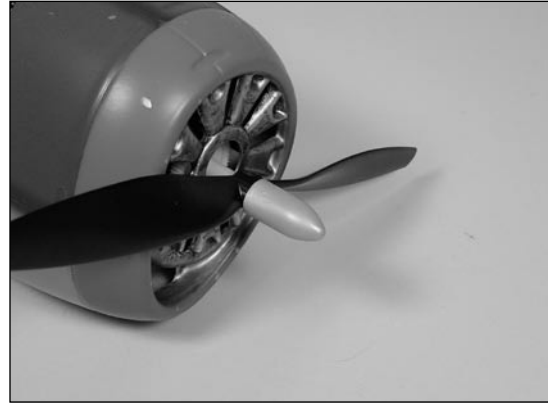

Outrunner Motor Installation

Required Parts

- Propeller
- Outrunner motor mount

Required Tools and Adhesives

- Wrench
- Foam-safe CA

Note: This section covers installation of the optional Park 400 or Park 450 outrunner motor. If you have opted to install the supplied gearbox and motor, or inrunner brushless motor and gearbox, skip this section.

- 1. Check the motor stick to make sure it is secure in the fuselage. Apply foam-safe CA as necessary to make sure the motor stick is secure.



- 2. Use a razor saw to carefully shorten the motor stick by $9/16"$ (15mm) if using the Park 400 outrunner motor, or 1" (25mm) if using the Park 450 outrunner motor.

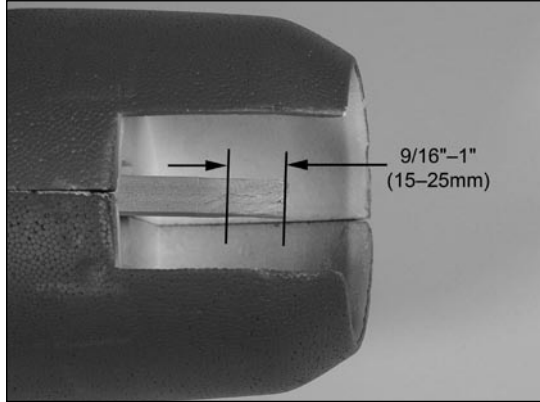

Note: Due to possible variations in motor stick length, it is best to confirm the amount required to shorten the stick using your chosen motor and mount before cutting the stick.

- 3. Attach your outrunner motor to the outrunner motor mount using the hardware included or provided with your motor if necessary.



Note: Some motors, like the Park 450 outrunner, may require the use of the included aluminum spacers between the motor and mount to provide adequate clearance for the shaft collar.

- 4. Slide the outrunner motor mount fully onto the motor stick. Secure the mount using a 2mm x 10mm screw.

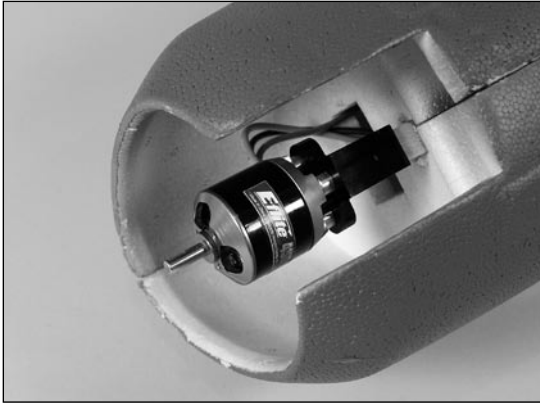

- 5. Remove the backing from the two-sided tape on the sides of the fuselage. Slide the cowling onto the fuselage, pressing it against the tape once you have confirmed proper alignment.



- 6. Slide the propeller adapter into position. Attach the propeller using the hardware from the motor. You may need to drill out or ream the prop mounting hole to fit the prop adapter. Tighten the spinner to hold the propeller on.



Final Assembly

Required Parts

- Battery pack
 - Bomb w/pylon (2)
 - Balancing clay
 - Two-sided tape 5mm x 70mm (2)
- 1. Install the battery pack into the fuselage. Attach the canopy hatch to complete assembly.

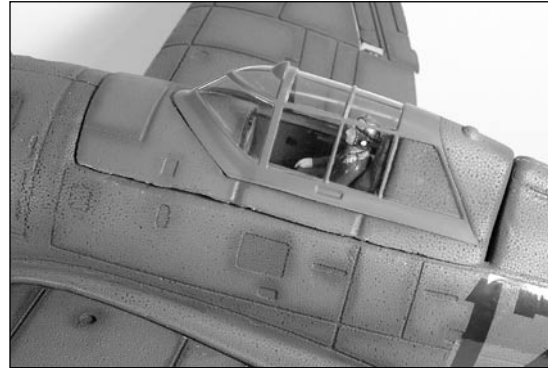
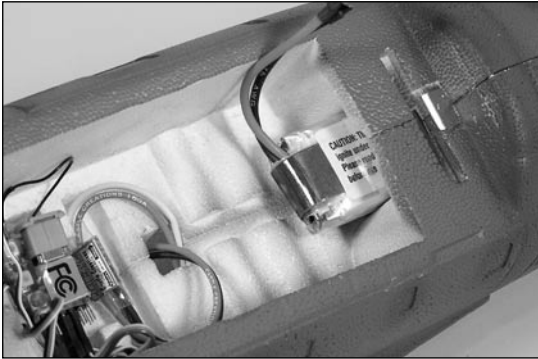

Note: Use the included hook and loop material on the battery and fuselage if the battery does not fit tightly.

- 2. Turn the model over and place your fingertips in the recess in the wing. The model will rest level when balanced. Move the battery forward or backward in the fuse to achieve balance. If the battery is at its limits, use the supplied clay to weight either the nose or tail to achieve balance.

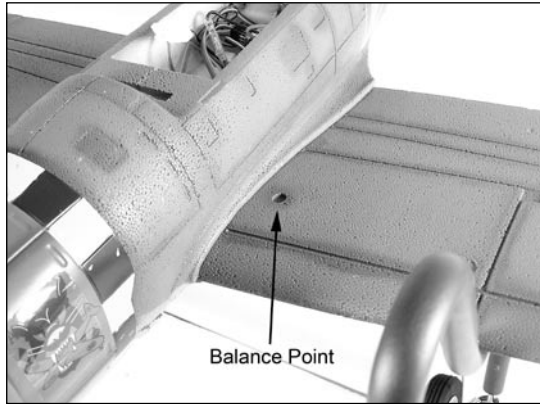

- 3. The optional bomb pylons can be attached to the bottom of the wing using the supplied 5mm x 70mm two-sided tape pieces. The bombs can be removed from the pylons by pulling them forward.

Note: Only install the bombs and pylons if the landing gear has been installed. Without the gear, the bombs and pylons can easily be damaged when landing on rough surfaces.

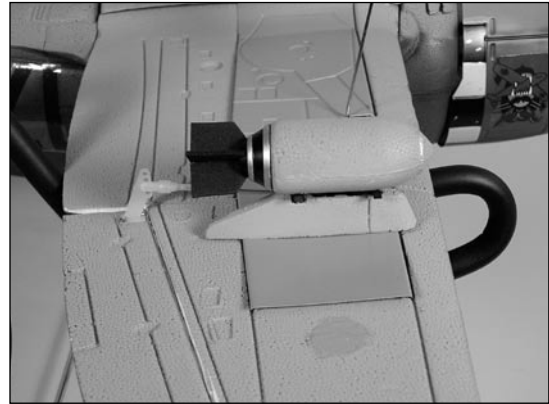

Control Throws

- 1. Turn on the transmitter and receiver of your P-47D Thunderbolt. Check the movement of the rudder using the transmitter. When the stick is moved right, the rudder should also move right. Reverse the direction of the servo at the transmitter if necessary.

- 2. Check the movement of the elevator with the radio system. Moving the elevator stick down will make the airplane elevator move up.

- 3. Check the movement of the aileron with the radio system. Moving the aileron stick to the right will make the left aileron go down and the right aileron go up.

- 4. Use a ruler to adjust the throw of the elevator, ailerons and rudder. Adjust the position of the pushrod at the control horn to achieve the following measurements when moving the sticks to their endpoints.

Ailerons:

1/2" (13mm) Up/Down

Elevator:

3/8" (10mm) Up/Down

Rudder:

3/8" (10mm) Right/Left

These are general guidelines measured from our own flight tests. You can experiment with lower or higher rates to match your preferred style of flying.

Range Testing the Radio

- 1. Before each flying session, be sure to range check your radio. This is accomplished by turning on your transmitter with the antenna collapsed. Turn on the receiver in your airplane. With your airplane on the ground and the engine running, you should be able to walk 30 paces (approximately 100 feet) away from your airplane and still have complete control of all functions. If not, don't attempt to fly! Have your radio equipment checked out by the manufacturer.

- 2. Double-check that all controls (aileron, elevator, rudder and throttle) move in the correct direction.

- 3. Be sure that your transmitter batteries are fully charged, per the instructions included with your radio.

Preflight

Check Your Radio

- Before going to the field, be sure that your batteries are fully charged, per the instructions included with your radio. Charge both the transmitter and receiver pack for your airplane. Use the recommended charger supplied with your particular radio system, following the instructions provided with the radio. In most cases the radio should be charged the night before going out flying.

Preflight (continued)

- Before each flying session, be sure to range check your radio. See your radio manual for the recommended range and instructions for your radio system. Each radio manufacturer specifies different procedures for their radio systems. Next, start the motor. With the model securely anchored, check the range again. The range test should not be significantly affected. If it is, don't attempt to fly! Have your radio equipment checked out by the manufacturer.

Note: Keep loose items that can get entangled in the propeller away from the prop. These include loose clothing, or other objects such as pencils and screwdrivers. Especially keep your hands away from the propeller.

- Double-check that all controls (aileron, elevator, rudder and throttle) move in the correct direction.

- Check the radio installation and make sure all the control surfaces are moving correctly (i.e. the correct direction and with the recommended throws). Test run the motor and make sure it transitions smoothly from off to full throttle and back. Also ensure the engine is installed according to the manufacturer's instructions, and it will operate consistently.
- Check all the control horns, servo horns, and clevises to make sure they are secure and in good condition. Replace any items that would be considered questionable. Failure of any of these components in flight would mean the loss of your aircraft.

Notes

Notes

Notes

Notes

2005 Official AMA National Model Aircraft Safety Code

GENERAL

- 1) I will not fly my model aircraft in sanctioned events, air shows or model flying demonstrations until it has been proven to be airworthy by having been previously, successfully flight tested.
- 2) I will not fly my model higher than approximately 400 feet within 3 miles of an airport without notifying the airport operator. I will give right-of-way and avoid flying in the proximity of full-scale aircraft. Where necessary, an observer shall be utilized to supervise flying to avoid having models fly in the proximity of full-scale aircraft.
- 3) Where established, I will abide by the safety rules for the flying site I use, and I will not willfully or deliberately fly my models in a careless, reckless and/or dangerous manner.
- 4) The maximum takeoff weight of a model is 55 pounds, except models flown under Experimental Aircraft rules.

5) I will not fly my model unless it is identified with my name and address or AMA number on or in the model. (This does not apply to models while being flown indoors.)

6) I will not operate models with metal-bladed propellers or with gaseous boosts, in which gases other than air enter their internal combustion engine(s); nor will I operate models with extremely hazardous fuels such as those containing tetranitromethane or hydrazine.

RADIO CONTROL

- 1) I will have completed a successful radio equipment ground range check before the first flight of a new or repaired model.
- 2) I will not fly my model aircraft in the presence of spectators until I become a qualified flier, unless assisted by an experienced helper.

2005 Official AMA National Model Aircraft Safety Code

3) At all flying sites a straight or curved line(s) must be established in front of which all flying takes place with the other side for spectators. Only personnel involved with flying the aircraft are allowed at or in front of the flight line. Intentional flying behind the flight line is prohibited.

4) I will operate my model using only radio control frequencies currently allowed by the Federal Communications Commission. (Only properly licensed Amateurs are authorized to operate equipment on Amateur Band frequencies.)

5) Flying sites separated by three miles or more are considered safe from site-to-site interference, even when both sites use the same frequencies. Any circumstances under three miles separation require a frequency management arrangement, which may be either an allocation of specific frequencies for each site or testing to determine that freedom from interference exists. Allocation plans or interference test reports shall be signed by the parties involved and provided to AMA Headquarters.

Documents of agreement and reports may exist between (1) two or more AMA Chartered Clubs, (2) AMA clubs and individual AMA members not associated with AMA Clubs, or (3) two or more individual AMA members.

6) For Combat, distance between combat engagement line and spectator line will be 500 feet per cubic inch of engine displacement. (Example: .40 engine = 200 feet.); electric motors will be based on equivalent combustion engine size. Additional safety requirements will be per the RC Combat section of the current Competition Regulations.

7) At air shows or model flying demonstrations, a single straight line must be established, one side of which is for flying, with the other side for spectators.

8) With the exception of events flown under AMA Competition rules, after launch, except for pilots or helpers being used, no powered model may be flown closer than 25 feet to any person.

9) Under no circumstances may a pilot or other person touch a powered model in flight.

E-fliteTM

HORIZON
H O B B Y

© 2005 Horizon Hobby, Inc.
4105 Fieldstone Road
Champaign, Illinois 61822
(877) 504-0233
horizonhobby.com
E-fliteRC.com