

P-40 Warhawk 300 ARF

Assembly Manual



Specifications

Wingspan:	25.6 in (650mm)
Wing Area:	108 sq in (7.02 sq dm)
Length:	21.7 in (550mm)
Weight (without battery):	5.5–6.0 oz (156–170 g)
Weight (with Li-Po Battery):	6.5–7.0 oz (184–198 g)



Table of Contents

Introduction	2
Important Warranty Information	2
Using the Manual	2
Product Registration	2
Contents of Kit/Parts Layout	2
Recommended Radio Equipment	3
Additional Electronics	3
Optional Accessories	3
Required Tools and Adhesives	3
Note on Lithium Polymer Batteries	3
Electronics Installation	3
Linkage Connections	6
Wing Installation	8
Battery Installation	9
Spinner Installation	9
Propeller Removal and Replacement	10
Display Stand Assembly	11
Control Throws	12
Center of Gravity	13
Preflight	13
Range Test Your Radio	14
Flying Your P-40 Warhawk	14
Safety Do's and Don'ts for Pilots	14
Age Requirements	14
Safety, Precautions and Warnings	15
Warranty Information	15
CE Compliance Information for the European Union	17
2009 Official Academy of Model Aeronautics Safety Code	17
Declaration of Conformity	18

Introduction

Thank you for purchasing the E-flite® P-40 Warhawk 300 ARF. On paper, the P-40 was outclassed by many of the foes it faced. But in the hands of the pilots of the American Volunteers Group, the Warhawk was used to deadly effect against “superior” Zeros. Their exploits made the iconic shark-toothed grin of the “Flying Tigers” a symbol of victory for the Allies and cause for concern to any enemy pilot that encountered it.

E-flite has captured the spirit of the Tigers in this fun-to-fly recreation of the P-40 that goes together fast and is small enough to fly in the park. It comes out of the box loaded with scale details like an authentic Flying Tigers paint scheme and molded panel lines. It also comes equipped with a factory-installed 300 BL outrunner motor that will provide plenty of power for warbird aerobatics like loops, rolls and Immelmans. Its simple 3-channel control setup means you only need to buy two servos – one for aileron and one for elevator – making it even more affordable to get flying. When you're not flying, you can show off its scale looks with included static display stand.

Important Warranty Information

Please read our Warranty and Liability Limitations section on Page 14 before building this product. If you as the Purchaser or user are not prepared to accept the liability associated with the use of this Product, you are advised to return this Product immediately in new and unused condition to the place of purchase.

Using the Manual

This manual is divided into sections to help make assembly easier to understand, and to provide breaks between each major section. In addition, check boxes have been placed next to each step to keep track of its completion.

Remember to take your time and follow the directions.

Product Registration

Register your product online at:
www.e-fliterc.com/register/

Contents of Kit/Parts Layout

EFL6076	Fuselage with Tail and Hatch
EFL6077	Main Wing
EFL6078	Propeller (2)
EFL6079	Spinner
EFL6080	Motor
EFL6081	Canopy Hatch
EFL6082	Wing Mount O-rings (3)
EFL6083	Horizontal Stabilizer

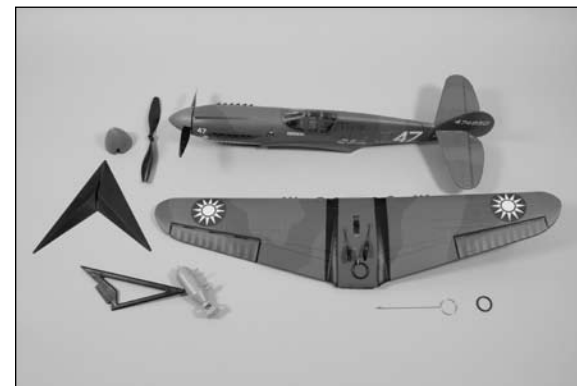

Recommended Radio Equipment

You will need a minimum 4-channel transmitter, receiver, and two servos. You can also choose to purchase a complete radio system. If you are using an existing transmitter, just purchase the other required equipment separately. We recommend the crystal-free, interference-free Spektrum™ DX5e 2.4GHz DSM® 5-channel system.

If you own the Spektrum DX5e radio, just add the AR6100e DSM2™ 6-channel receiver and two E-flite S60 Super Sub-Micro Servos.

Transmitter and Receiver

SPMAR5500 DX5e 5-Channel Transmitter only, Mode 2

Purchase Separately

SPMAR6100E AR6100E 6-Channel Receiver, Air

And

EFLRS60 S60 Super Sub Micro Servo (2)

Additional Electronics

EFLB4302SJ 430mAh 2S 7.4V 20C LiPo, 20AWG JST
EFLA1010 10-Amp Pro Brushless ESC

The Spektrum trademark is used with permission of Bachmann Industries, Inc.

Optional Accessories

EFLA110 Power Meter
EFLC3005 Celetra™ 1-3 Cell Li-Po Charger
EFLC505 Intelligent 1- to 5-Cell Balancing Charger

Required Tools and Adhesives

Tools & Equipment

Hobby knife with #11 blade
Phillips screwdriver: #0
Flat blade screwdriver
Nut driver: 5mm
Two-sided tape
Ruler

Adhesives

Foam CA 1 oz/Activator 2 oz Pack (EFLA208)
Canopy Glue (PAAPT56)

Note on Lithium Polymer Batteries



Lithium Polymer batteries are significantly more volatile than alkaline or Ni-Cd/ Ni-MH batteries used in RC applications. All manufacturer's instructions and warnings must be followed closely. Mishandling of Li-Po batteries can result in fire. Always follow the manufacturer's instructions when disposing of Lithium Polymer batteries.

E-tips

During the course of building your model we suggest that you use a soft base for the building surface. Such things as a foam stand, large piece of bedding foam or a thick bath towel will work well and help protect the model from damage during assembly.

Electronics Installation

Required Parts

Fuselage assembly Wing assembly
Servo with horn (2) Receiver
Speed control Flight battery
Transmitter

Required Tools

Foam-safe CA Hobby knife with #11 blade
Two-sided tape Phillips screwdriver: #0

E-tips

If you are using a computer radio, it is recommended to start with a new program and clear it before starting the installation of the electronics. Make sure the trims, sub-trims and sticks are centered, and no programmable mixing has been turned on as well.

1. Use a #0 Phillips screwdriver to remove the servo horns from the two servos.

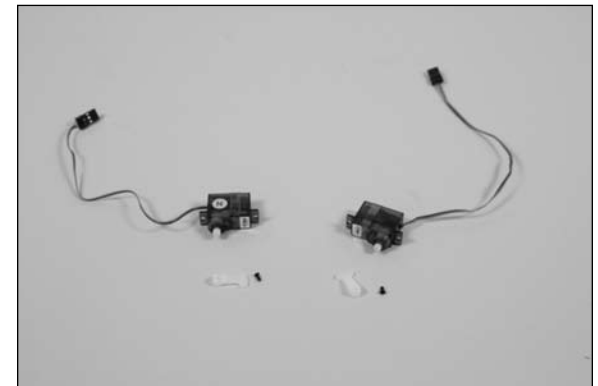

- 2. Use a hobby knife with a #11 blade to cut a narrow notch at the edge of the servo pocket in the wing to allow the servo wire from the aileron servo to fit in.



- 3. Press the servo into the servo pocket in the wing. Make sure to guide the servo wire into the notch made in the previous step. Note that the output of the servo faces to the trailing edge (rear) of the wing.



- 4. Place a drop or two of foam-safe CA in the hole in the servo tab. The CA will go through the hole and bond the servo to the wing.



- 5. Use a hobby knife with a #11 blade to cut a narrow notch at the edge of the servo pocket in the fuselage for the elevator servo to allow the servo wire to fit in.



- 6. Press the servo into the servo pocket in the fuselage. Make sure to guide the servo wire into the notch made in the previous step. Note that the output of the servo faces to the front of the fuselage. Place a drop or two of foam-safe CA in the hole in the servo tab. The CA will go through the hole and bond the servo to the fuselage.



- 7. Plug the speed control and elevator servo connectors into the receiver.

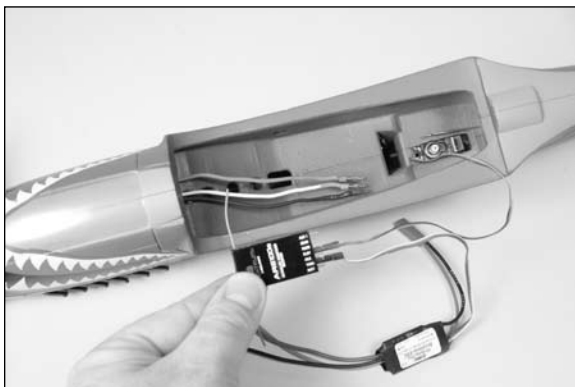

- 8. Place a small piece of two-sided tape on the receiver. Slide the receiver into the fuselage and press it against the tape to secure it into the fuselage. Make sure to leave enough of the receiver exposed to know which port to plug the aileron servo into.

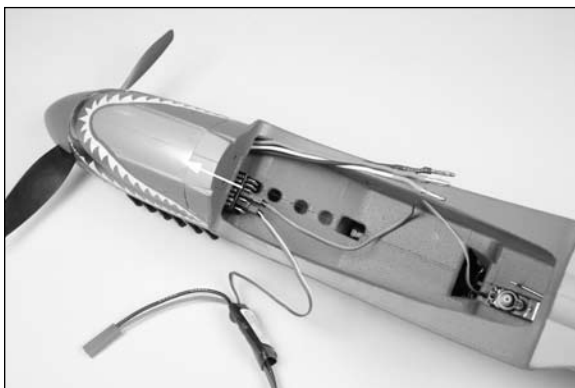

- 9. Connect the leads from the motor to the speed control.

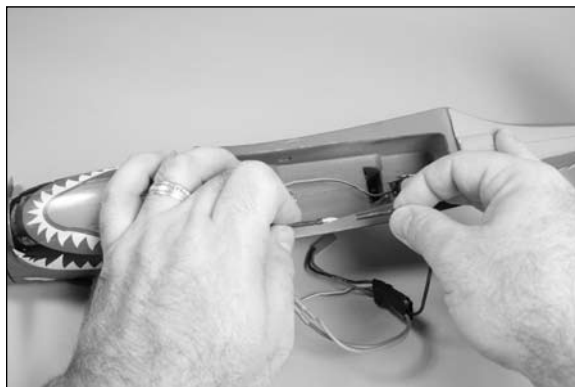

- 10. Use two-sided tape to secure the speed control in the fuselage as shown.

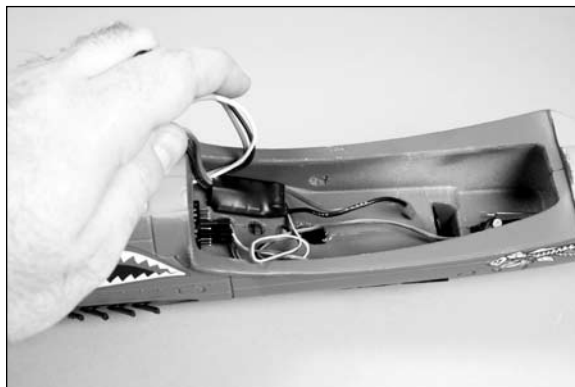

Etips

Before checking the rotation of your motor, make sure to remove the propeller to avoid any accidental injuries. The details for removing the propeller can be found on Page 10, "Propeller Removal and Installation."

- 11. Check the operation of your motor at this time using the radio system. The motor should spin counterclockwise when viewed from the front of the fuselage. If not, follow the speed control manufacturer's recommendations to reverse the direction if necessary. Once the direction of rotation is verified, you can install the propeller back on the motor.

- 12. Tuck the motor leads in the fuselage as shown.



- 13. Insert the lead for the battery from the speed control into the larger hole in the fuselage. The lead will enter the compartment under the canopy.

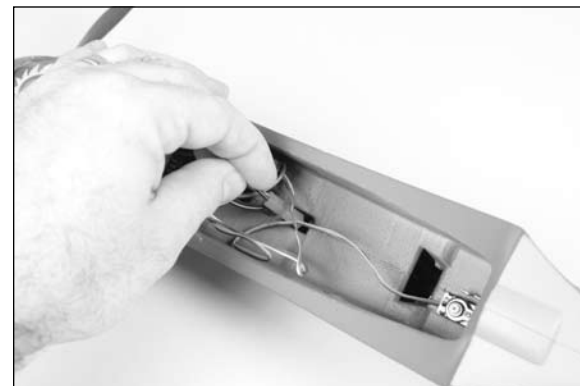

Linkage Connections

Required Parts

Fuselage assembly Wing assembly
Flight battery Transmitter
Single-sided servo horn
Double-sided servo horn

Required Tools

Ruler Flat blade screwdriver
Phillips screwdriver: #0
Hobby knife with #11 blade

- 1. Inspect the clevis and its connection to the elevator control horn. Note which hole the clevis is attached to. Use a flat blade screwdriver to open the clevis and remove it from the elevator control horn.

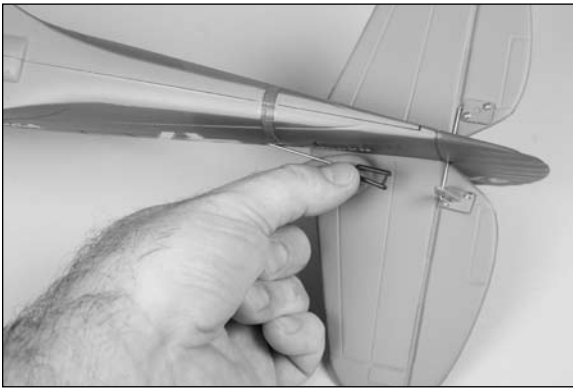

- 2. Use a hobby knife to enlarge the hole in a single-sided servo horn that is 9/32-inch (7mm) from the center of the servo horn. The hole needs to be big enough to insert the pushrod wire for the elevator. Use care not to make the hole too large as this will cause slop in the control system.

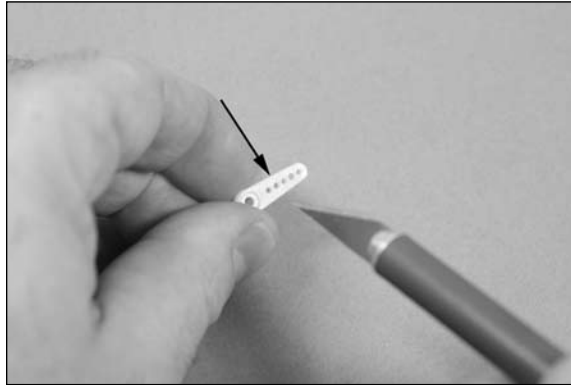

- 3. Insert the pushrod wire from the elevator into the hole enlarged in the previous step.



- 4. Use the radio system to center the elevator servo. Secure the servo horn to the elevator servo using the screw removed in the previous section of the manual. You will need a #0 Phillips screwdriver to tighten the screw.



- 5. Reconnect the clevis to the elevator control horn in the hole noted in Step 1. Make sure the clevis is secure before proceeding. Check to see that the elevator is level when the servo is centered. If not adjust the clevis to the correct length by adjusting the clevis in or out on the pushrod.



- 6. Use a hobby knife to enlarge the holes in a double-sided servo horn that is 1/2-inch (13mm) from the center of the servo horn. The hole needs to be big enough to insert the pushrod wires for the ailerons. Use care not to make the hole too large as this will cause slop in the control system.

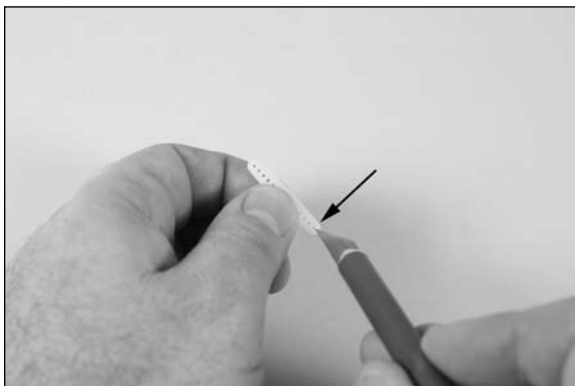

- 7. Install the servo horn on the aileron linkages by inserting both linkages into the holes in the servo arm. The arm is then rotated on the bends so the splines face to the aileron servo.



- 8. Use the radio system to center the aileron servo. Secure the servo horn to the aileron servo using the screw removed in the previous section of the manual. You will need a #0 Phillips screwdriver to tighten the screw.



- 9. Check to make sure the aileron is aligned with the trailing edge of the wing. If not, thread the clevis in or out until the two are aligned. Make sure to check both the left and right ailerons.

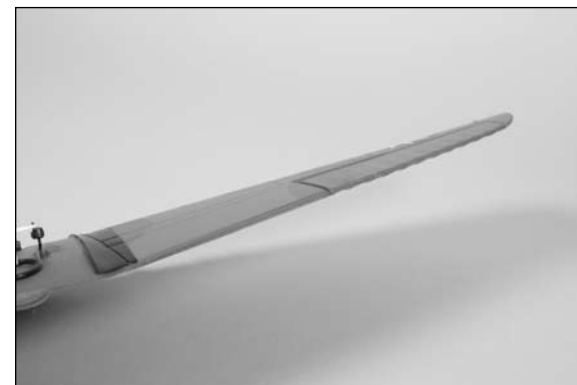

Wing Installation

Required Parts

Fuselage assembly Wing assembly
O-ring tool

Etips

Before installing the wing stretch the O-ring slightly by holding the base of the mount in the wing and pulling tension on the O-ring. Do not use much force as you could damage the wing or the mount. Repeat this process 2 or 3 times. This will allow the O-ring to stretch some before it is installed.

- 1. Remove the canopy from the fuselage by lifting it upward. The canopy is held on with magnets.



- 2. Plug the aileron servo into the receiver.

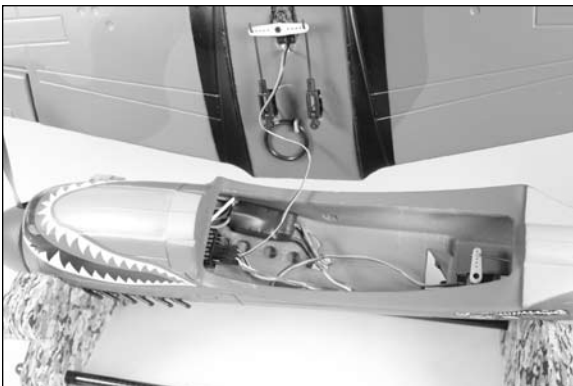

- 3. Position the wing on the bottom of the fuselage. The pins at the front of the wing will slide into the holes in the fuselage.



- 4. Press the rear of the wing down so the wing fits tight against the fuselage. Make sure none of the wires from the inside of the fuselage are exposed on the top side of the wing.



- 5. Use the O-ring tool to pull the O-ring upward so it can be hooked onto the tab at the rear of the cockpit as shown.



Battery Installation

Required Parts

Assembled airframe Motor battery

- 1. Slide the motor battery into the fuselage. It should slide in easily with little force.



- 2. When you are ready to fly your aircraft, connect the lead from the battery to the lead from the speed control. Tuck the leads into the hole or alongside the battery so the canopy can be installed.



- 3. Place the canopy back on the fuselage.



E-tips

Make sure that the leads are tucked into the hole in the fuselage so that the canopy fits correctly on the model. If not you could loose your canopy during flight.

Spinner Installation

Required Parts

Fuselage assembly Spinner

Required Tools

Nut driver: 5mm Canopy glue

PLEASE NOTE THAT YOUR SPINNER IS NOT GLUED ON FROM THE FACTORY. IT IS JUST SLID ON TO THE PROP AND NEEDS TO BE REMOVED AND GLUED ON FOR SAFETY.

- 1. Apply a small amount of canopy glue to the nut. Use a small amount so the spinner can be easily removed if the propeller requires replacement.



- 2. Slide the spinner back on the propeller. Allow the glue to fully cure before flying your model.



Propeller and Spinner Removal and Replacement

Required Parts

Fuselage assembly Propeller
Spinner

Required Tools

Nut driver: 5mm Canopy glue

- 1. Carefully pull the spinner forward to remove it from the motor. It will take a small amount of force to remove.

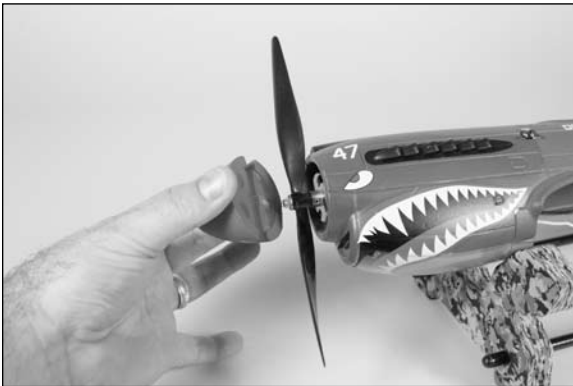

- 2. Use a 5mm nut driver to remove the nut holding the propeller on the motor.



- 3. Remove the washer and propeller from the motor.

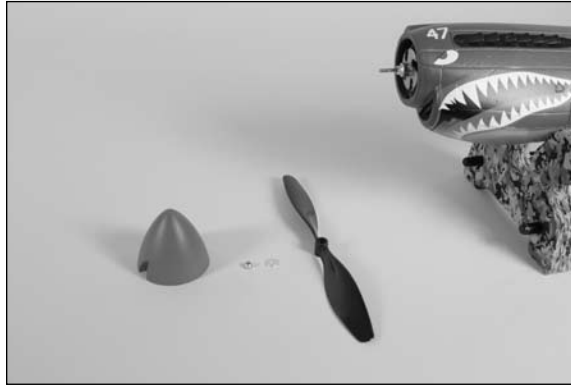

Etips

If you are checking the rotation of the motor, now is the time to do so while the propeller is removed.

- 4. Before installing a new propeller, make sure it is installed in the correct direction. One side will have a hex that keys to the motor. Make sure it is installed with this hex toward the motor.



- 5. Slide the propeller on the motor shaft.

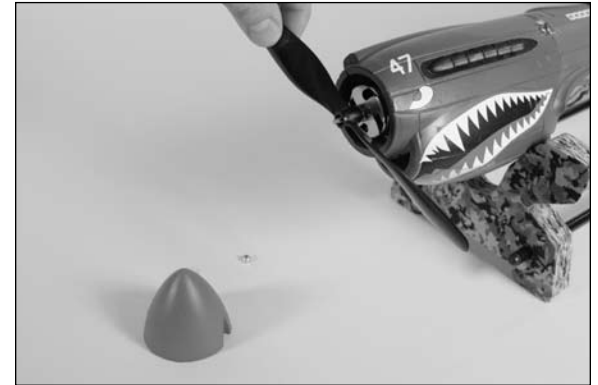

- 6. Next, slide the washer back on the motor shaft. Thread the 5mm locknut back on the shaft.



- 7. Use a 5mm nut driver to tighten the nut holding the propeller on the motor.

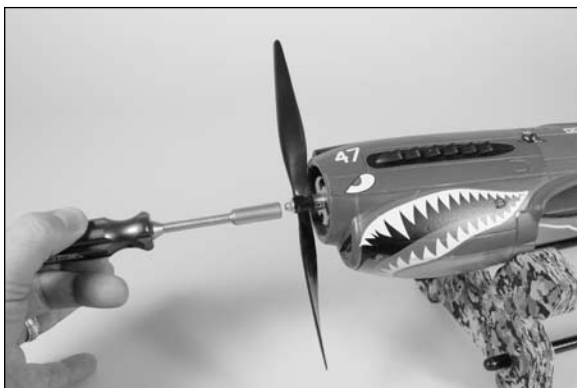

- 8. Apply a small amount of canopy glue to the nut. Use a small amount so the spinner can be easily removed if the propeller requires replacement.



- 9. Slide the spinner back on the propeller. Allow the glue to fully cure before flying your model.



Display Stand Assembly

Required Parts

Assembled airframe Display stand base
Display stand strut

- 1. Insert the tab from the display stand strut into the slot in the display stand base. They will fit tight and not require glue to keep them from coming apart.

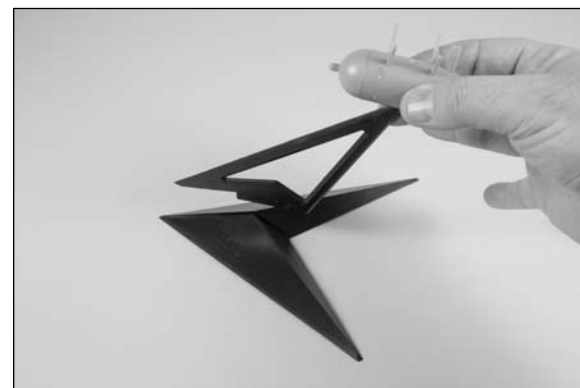

- 2. The mount for the plane can swivel on the display stand strut. This allows you to position your model for the best dramatic effect while on display.

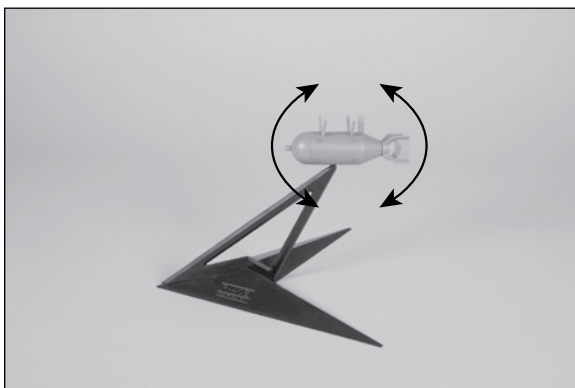

- 3. The plane will rest on the mount. The straight pin on the mount is inserted into the hole in the area of the finger grips as shown.

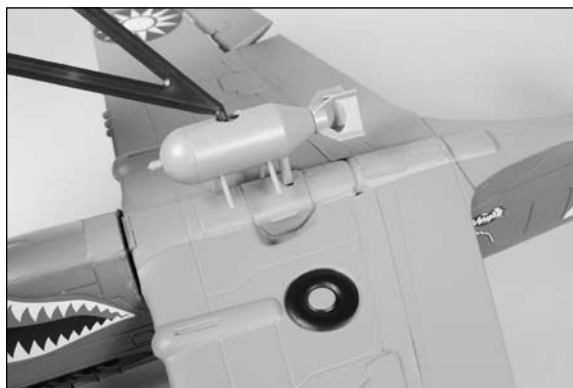

- 4. With the stand and plane upright, you are now able to display your model when you are not out flying sorties.



Control Throws

- 1. Turn on the transmitter and receiver of your model.
- 2. Check the movement of the elevator with the radio system. Moving the elevator stick toward the bottom of the transmitter will make the airplane elevator move up.
- 3. Check the movement of the ailerons with the radio system. Moving the aileron stick right will make the right aileron move up and the left aileron move down.
- 4. Use a ruler to adjust the throw of the elevator and ailerons.

Center of Gravity

An important part of preparing the aircraft for flight is properly balancing the model.

Caution: Do not inadvertently skip this step!

The recommended Center of Gravity (CG) location for your model is $1\frac{1}{8}$ to $1\frac{1}{4}$ inches (28–35mm) back from the leading edge of the wing at the inside edge next to the fuselage. Make sure to measure from the farthest point forward for accuracy. Mark the location for the Center of Gravity on the top of the wing next to the fuselage as shown. Make sure to check the balance point with the flight battery installed.

Adjust the speed control and receiver as necessary so the model hangs level or slightly nose down. This is the correct balance point for your model.

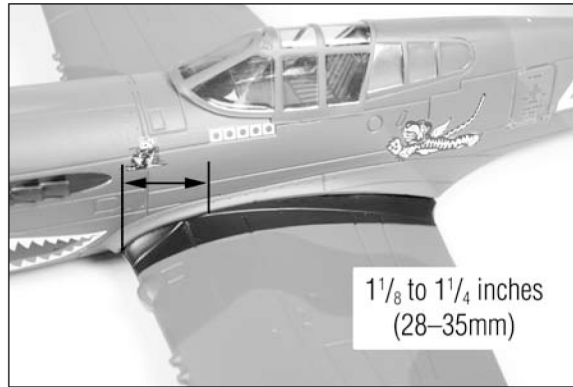

After the first flights, the CG position can be adjusted for your personal preference.

Preflight

Check Your Radio

Before going to the field, be sure that your batteries are fully charged per the instructions included with your radio. Charge both the transmitter and receiver pack (if so equipped) for your airplane. Use the recommended charger supplied with your particular radio system, following the instructions provided with the radio. In most cases, the radio should be charged the night before going out flying.

Before each flying session, be sure to range check your radio. See your radio manual for the recommended range and instructions for your radio system. Each radio manufacturer specifies different procedures for their radio systems. Next, start the motor. With the model securely held by a helper (staying clear of the propeller), check the range again. The range test should not be significantly affected. If it is, don't attempt to fly! Have your radio equipment checked out by the manufacturer.

Note: Keep loose items that can get entangled in the propeller away from the prop. These include loose clothing, or other objects such as pencils and screwdrivers. Especially keep your hands away from the propeller.

Double-check that all controls (aileron, elevator and throttle) move in the correct direction.

Check the radio installation and make sure all the control surfaces are moving correctly (i.e. the correct direction and with the recommended throws). Test run the motor and make sure it transitions smoothly from off to full throttle and back. Also ensure the motor is installed according to the manufacturer's instructions, and it will operate consistently.

Check all the control horns, servo horns, and clevises to make sure they are secure and in good condition. Repair or replace any items that would be considered questionable. Failure of any of these components in flight would mean the loss of your aircraft.

Aileron High Rate

Up 5/16-inch (8mm)
Down 5/16-inch (8mm)

Aileron Low Rate

Up 1/4-inch (6mm)
Down 1/4-inch (6mm)

Elevator High Rate

Up 3/16-inch (5mm)
Down 3/16-inch (5mm)

Elevator Low Rate

Up 5/32-inch (4mm)
Down 5/32-inch (4mm)

E-tips

Measurements are taken at the inner or widest point on the control surface.

E-tips

You will notice that the elevator throw for the P-40 has very little travel. This is due to the sensitivity of the elevator. The elevator is very responsive and will not require any more travel than this.

These are general guidelines measured from our own flight tests. You can experiment with higher rates to match your preferred style of flying.

E-tips

Travel Adjust, Sub Trim and Exponential are not listed and should be adjusted according to each individual model and preference.

Range Test Your Radio

- 1. Before each flying session, be sure to range check your radio. See your radio manual for the recommended range and instructions for your radio system. Each radio manufacturer specifies different procedures for their radio systems. Next, start the motor. With the model securely anchored, check the range again. The range test should not be significantly affected. If it is, don't attempt to fly! Have your radio equipment checked out by the manufacturer.
- 2. Double-check that all controls (aileron, elevator and throttle) move in the correct direction.
- 3. Be sure that your transmitter batteries are fully charged, per the instructions included with your radio.

Flying Your P-40 Warhawk

Flying the P-40 Warhawk is a pleasure you will not soon forget. A gentle hand launch with full throttle is all that is needed to get the P-40 into the air. Once you are airborne, you will find that the P-40 is very smooth and handles very well. Basic aerobatics such as loops and rolls are a breeze with the P-40. Both high and low speed flight are also easily obtained. When it is time to land, a gentle descent while carrying a little power is all that is needed. Once you are over the threshold and about one foot off the ground, pull the power off and gently apply up elevator to flair for a smooth landing.

Happy Landings!

Safety Do's and Don'ts for Pilots

- Check all control surfaces prior to each takeoff.
- Do not fly your model near spectators, parking areas or any other area that could result in injury to people or damage of property.
- Do not fly during adverse weather conditions. Poor visibility can cause disorientation and loss of control of your aircraft. Strong winds can cause similar problems.
- Do not take chances. If at any time during flight you observe any erratic or abnormal operation, land immediately and do not resume flight until the cause of the problem has been ascertained and corrected. Safety can never be taken lightly.
- Do not fly near power lines.

Age Requirements

Age Recommendation: 14 years or over. This is not a toy. This product is not intended for use by children without direct adult supervision.

Safety, Precautions and Warnings

As the user of this product, you are solely responsible for operating it in a manner that does not endanger yourself and others or result in damage to the product or the property of others.

Carefully follow the directions and warnings for this and any optional support equipment (chargers, rechargeable battery packs, etc.) that you use.

This model is controlled by a radio signal that is subject to interference from many sources outside your control. This interference can cause momentary loss of control so it is necessary to always keep a safe distance in all directions around your model, as this margin will help to avoid collisions or injury.

- Always operate your model in an open area away from cars, traffic or people.
- Avoid operating your model in the street where injury or damage can occur.
- Never operate the model out into the street or populated areas for any reason.
- Never operate your model with low transmitter batteries.
- Carefully follow the directions and warnings for this and any optional support equipment (chargers, rechargeable battery packs, etc.) that you use.
- Keep all chemicals, small parts and anything electrical out of the reach of children.
- Moisture causes damage to electronics. Avoid water exposure to all equipment not specifically designed and protected for this purpose.

Warranty Information

WARRANTY PERIOD

Exclusive Warranty- Horizon Hobby, Inc., (Horizon) warranties that the Products purchased (the "Product") will be free from defects in materials and workmanship at the date of purchase by the Purchaser.

LIMITED WARRANTY

(a) This warranty is limited to the original Purchaser ("Purchaser") and is not transferable. REPAIR OR REPLACEMENT AS PROVIDED UNDER THIS WARRANTY IS THE EXCLUSIVE REMEDY OF THE PURCHASER. This warranty covers only those Products purchased from an authorized Horizon dealer. Third party transactions are not covered by this warranty. Proof of purchase is required for warranty claims. Further, Horizon reserves the right to change or modify this warranty without notice and disclaims all other warranties, express or implied.

(b) Limitations- HORIZON MAKES NO WARRANTY OR REPRESENTATION, EXPRESS OR IMPLIED, ABOUT NON-INFRINGEMENT, MERCHANTABILITY OR FITNESS FOR A PARTICULAR PURPOSE OF THE PRODUCT. THE PURCHASER ACKNOWLEDGES THAT THEY ALONE HAVE DETERMINED THAT THE PRODUCT WILL SUITABLY MEET THE REQUIREMENTS OF THE PURCHASER'S INTENDED USE.

(c) Purchaser Remedy- Horizon's sole obligation hereunder shall be that Horizon will, at its option, (i) repair or (ii) replace, any Product determined by Horizon to be defective. In the event of a defect, these are the Purchaser's exclusive remedies. Horizon reserves the right to inspect any and all equipment involved in a warranty claim. Repair or replacement decisions are at the sole discretion of Horizon. This warranty does not cover cosmetic damage or damage due to acts of God, accident, misuse, abuse, negligence, commercial use, or modification of or to any part of the Product. This warranty does not cover damage due to improper installation, operation, maintenance, or attempted repair by anyone other than Horizon. Return of any goods by Purchaser must be approved in writing by Horizon before shipment.

DAMAGE LIMITS

HORIZON SHALL NOT BE LIABLE FOR SPECIAL, INDIRECT OR CONSEQUENTIAL DAMAGES, LOSS OF PROFITS OR PRODUCTION OR COMMERCIAL LOSS IN ANY WAY CONNECTED WITH THE PRODUCT, WHETHER SUCH CLAIM IS BASED IN CONTRACT, WARRANTY, NEGLIGENCE, OR STRICT LIABILITY. Further, in no event shall the liability of Horizon exceed the individual price of the Product on which liability is asserted. As Horizon has no control over use, setup, final assembly, modification or misuse, no liability shall be assumed nor accepted for any resulting damage or injury. By the act of use, setup or assembly, the user accepts all resulting liability.

If you as the Purchaser or user are not prepared to accept the liability associated with the use of this Product, you are advised to return this Product immediately in new and unused condition to the place of purchase.

Law: These Terms are governed by Illinois law (without regard to conflict of law principals).

SAFETY PRECAUTIONS

This is a sophisticated hobby Product and not a toy. It must be operated with caution and common sense and requires some basic mechanical ability. Failure to operate this Product in a safe and responsible manner could result in injury or damage to the Product or other property. This Product is not intended for use by children without direct adult supervision. The Product manual contains instructions for safety, operation and maintenance. It is essential to read and follow all the instructions and warnings in the manual, prior to assembly, setup or use, in order to operate correctly and avoid damage or injury.

QUESTIONS, ASSISTANCE, AND REPAIRS

Your local hobby store and/or place of purchase cannot provide warranty support or repair. Once assembly, setup or use of the Product has been started, you must contact Horizon directly. This will enable Horizon to better answer your questions and service you in the event that you may need any assistance. For questions or assistance, please direct your email to productsupport@horizonhobby.com, or call 877.504.0233 toll free to speak to a service technician.

INSPECTION OR REPAIRS

If this Product needs to be inspected or repaired, please call for a Return Merchandise Authorization (RMA). Pack the Product securely using a shipping carton. Please note that original boxes may be included, but are not designed to withstand the rigors of shipping without additional protection. Ship via a carrier that provides tracking and insurance for lost or damaged parcels, as Horizon is not responsible for merchandise until it arrives and is accepted at our facility. A Service Repair Request is available at www.horizonhobby.com on the "Support" tab. If you do not have internet access, please include a letter with your complete name, street address, email address and phone number where you can be reached during business days, your RMA number, a list of the included items, method of payment for any non-warranty expenses and a brief summary of the problem. Your original sales receipt must also be included for warranty consideration. Be sure your name, address, and RMA number are clearly written on the outside of the shipping carton.

WARRANTY INSPECTION AND REPAIRS

To receive warranty service, you must include your original sales receipt verifying the proof-of-purchase date. Provided warranty conditions have been met, your Product will be repaired or replaced free of charge. Repair or replacement decisions are at the sole discretion of Horizon Hobby.

NON-WARRANTY REPAIRS

Should your repair not be covered by warranty the repair will be completed and payment will be required without notification or estimate of the expense unless the expense exceeds 50% of the retail purchase cost. By submitting the item for repair you are agreeing to payment of the repair without notification. Repair estimates are available upon request. You must include this request with your repair. Non-warranty repair estimates will be billed a minimum of 1/2 hour of labor. In addition you will be billed for return freight. Please advise us of your preferred method of payment. Horizon accepts money orders and cashiers checks, as well as Visa, MasterCard, American Express, and Discover cards. If you choose to pay by credit card, please include your credit card number and expiration date. Any repair left unpaid or unclaimed after 90 days will be considered abandoned and will be disposed of accordingly. Please note: non-warranty repair is only available on electronics and model engines.

United States:

Electronics and engines requiring inspection or repair should be shipped to the following address:

Horizon Service Center
4105 Fieldstone Road
Champaign, Illinois 61822

All other Products requiring warranty inspection or repair should be shipped to the following address:

Horizon Product Support
4105 Fieldstone Road
Champaign, Illinois 61822

Please call 877-504-0233 or e-mail us at productsupport@horizonhobby.com with any questions or concerns regarding this product or warranty.

United Kingdom:

Electronics and engines requiring inspection or repair should be shipped to the following address:

Horizon Hobby UK
Units 1-4 Ployters Rd
Staple Tye
Harlow, Essex
CM18 7NS
United Kingdom

Please call +44 (0) 1279 641 097 or e-mail us at sales@horizonhobby.co.uk with any questions or concerns regarding this product or warranty.

Germany:

Electronics and engines requiring inspection or repair should be shipped to the following address:

Horizon Technischer Service
Hamburger Strasse 10
25335 Elmshorn
Germany

Please call +49 4121 46199 66 or e-mail us at service@horizonhobby.de with any questions or concerns regarding this product or warranty

CE Compliance Information for the European Union

INSTRUCTIONS FOR DISPOSAL OF WEEE BY USERS IN THE EUROPEAN UNION

This product must not be disposed of with other waste. Instead, it is the user's responsibility to dispose of their waste equipment by handing it over to a designated collection point for the recycling of waste electrical and electronic equipment. The separate collection and recycling of your waste equipment at the time of disposal will help to conserve natural resources and ensure that it is recycled in a manner that protects human health and the environment. For more information about where you can drop off your waste equipment for recycling, please contact your local city office, your household waste disposal service or where you purchased the product.



2009 Official Academy of Model Aeronautics Safety Code

GENERAL

1. A model aircraft shall be defined as a non-human-carrying device capable of sustained flight in the atmosphere. It shall not exceed limitations established in this code and is intended to be used exclusively for recreational or competition activity.
2. The maximum takeoff weight of a model aircraft, including fuel, is 55 pounds, except for those flown under the AMA Experimental Aircraft Rules.
3. I will abide by this Safety Code and all rules established for the flying site I use. I will not willfully fly my model aircraft in a reckless and/or dangerous manner.
4. I will not fly my model aircraft in sanctioned events, air shows, or model demonstrations until it has been proven airworthy.
5. I will not fly my model aircraft higher than approximately 400 feet above ground level, when within three (3) miles of an airport without notifying the airport operator. I will yield the right-of-way and avoid flying in the proximity of full-scale aircraft, utilizing a spotter when appropriate.
6. I will not fly my model aircraft unless it is identified with my name and address, or AMA number, inside or affixed to the outside of the model aircraft. This does not apply to model aircraft flown indoors.
7. I will not operate model aircraft with metal-blade propellers or with gaseous boosts (other than air), nor will I operate model aircraft with fuels containing tetranitromethane or hydrazine.

8. I will not operate model aircraft carrying pyrotechnic devices which explode, burn, or propel a projectile of any kind. Exceptions include Free Flight fuses or devices that burn producing smoke and are securely attached to the model aircraft during flight. Rocket motors up to a G-series size may be used, provided they remain firmly attached to the model aircraft during flight. Model rockets may be flown in accordance with the National Model Rocketry Safety Code; however, they may not be launched from model aircraft. Officially designated AMA Air Show Teams (AST) are authorized to use devices and practices as defined within the Air Show Advisory Committee Document.
9. I will not operate my model aircraft while under the influence of alcohol or within eight (8) hours of having consumed alcohol.
10. I will not operate my model aircraft while using any drug which could adversely affect my ability to safely control my model aircraft.
11. Children under six (6) years old are only allowed on a flightline or in a flight area as a pilot or while under flight instruction.
12. When and where required by rule, helmets must be properly worn and fastened. They must be OSHA, DOT, ANSI, SNELL or NOCSAE approved or comply with comparable standards.

RADIO CONTROL

1. All model flying shall be conducted in a manner to avoid flying over unprotected people.
2. I will have completed a successful radio equipment ground-range check before the first flight of a new or repaired model aircraft.
3. I will not fly my model aircraft in the presence of spectators until I become a proficient flier, unless I am assisted by an experienced pilot.

4. At all flying sites a line must be established, in front of which all flying takes place. Only personnel associated with flying the model aircraft are allowed at or in front of the line. In the case of airshows demonstrations straight line must be established. An area away from the line must be maintained for spectators. Intentional flying behind the line is prohibited.
5. I will operate my model aircraft using only radio-control frequencies currently allowed by the Federal Communications Commission (FCC). Only individuals properly licensed by the FCC are authorized to operate equipment on Amateur Band frequencies.
6. I will not knowingly operate my model aircraft within three (3) miles of any preexisting flying site without a frequency-management agreement. A frequency management agreement may be an allocation of frequencies for each site, a day-use agreement between sites, or testing which determines that no interference exists. A frequency-management agreement may exist between two or more AMA chartered clubs, AMA clubs and individual AMA members, or individual AMA members. Frequency-management agreements, including an interference test report if the agreement indicates no interference exists, will be signed by all parties and copies provided to AMA Headquarters.
7. With the exception of events flown under official AMA rules, no powered model may be flown outdoors closer than 25 feet to any individual, except for the pilot and located at the flightline.
8. Under no circumstances may a pilot or other person touch a model aircraft in flight while it is still under power, except to divert it from striking an individual.
9. Radio-controlled night flying is limited to low-performance model aircraft (less than 100 mph). The model aircraft must be equipped with a lighting system which clearly defines the aircraft's attitude and direction at all times.

10. The operator of a radio-controlled model aircraft shall control it during the entire flight, maintaining visual contact without enhancement other than by corrective lenses that are prescribed for the pilot. No model aircraft shall be equipped with devices which allow it to be flown to a selected location which is beyond the visual range of the pilot.

P-40 Warhawk Safe Operating Recommendations

- Inspect your model before every flight to make certain it is airworthy.
- Be aware of any other radio frequency user who may present an interference problem.
- Always be courteous and respectful of other users of your selected flight area.
- Choose an area clear of obstacles and large enough to safely accommodate your flying activity.
- Make certain this area is clear of friends and spectators prior to launching your aircraft.
- Be aware of other activities in the vicinity of your flight path that could cause potential conflict.
- Carefully plan your flight path prior to launch.
- Abide by any and all established AMA National Model Aircraft Safety Code.

Declaration of Conformity

(in accordance with ISO/IEC 17050-1)

No. HH20090501

Product(s): P-40 Warhawk 300 ARF

Item Number(s): EFL6075

Equipment class: 1

The object of declaration described above is in conformity with the requirements of the specifications listed below, following the provisions of the European R&TTE directive 1999/5/EC:

EN 301 489-1 v.1.6.1 General EMC requirements

EN 301 489-17 v.1.2.1

Signed for and on behalf of:

Horizon Hobby, Inc.

Champaign, IL USA

May 1, 2009

Steven A. Hall

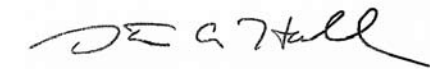

Vice President

International Operations and Risk Management

Horizon Hobby, Inc.



© 2009 Horizon Hobby, Inc.
4105 Fieldstone Road
Champaign, Illinois 61822
U.S.A.
(877) 504-0233
horizonhobby.com
E-fliteRC.com