

# F-15 Eagle ARF

Assembly Manual



## Specifications

Wingspan:	36 in (915mm)
Length:	47 in (1195mm)
Wing Area:	400 sq in (25.8 sq dm)
Weight w/ Battery:	1.9-2.1 lb (0.9-1.0 kg)
Weight w/o Battery:	2.5-3.1 oz (1.1-1.4 kg)

## Table of Contents

Specifications .....	1
Introduction.....	2
Using the Manual.....	2
Contents of Kit/Parts Layout.....	3
Required Radio Equipment.....	3
Important Information About Motor Selection .....	4
Motor Setup.....	4
Required Tools and Adhesives .....	4
Optional Accessories .....	4
Warranty Information .....	5
Note on Lithium Polymer Batteries .....	7
Warning.....	7
Safety, Precautions, and Warnings .....	7
Stabilator Installation .....	8
Motor and Fan Installation .....	11
Fixed Gear Installation.....	15
Retract Installation .....	18
Aileron Servo Installation .....	25
Wing Panel Installation .....	27
Receiver Installation .....	28
Vertical Fin Installation.....	29
Canopy Installation.....	30
Control Throws.....	31
Center of Gravity .....	32
Range Test Your Radio .....	32
Instructions for Disposal of WEEE by Users in the European Union .....	32
Preflight .....	33
Flying the F-15 Eagle .....	33
2008 Official AMA National Model Aircraft Safety Code ...	34

## Introduction

The McDonnell Douglas Corporation's F-15 Eagle was designed to be a tactical fighter to gain and maintain air superiority in aerial combat. The F-15 Eagle was developed out of the lessons learned from Vietnam and the need for the United States Air Force to have a dedicated air superiority fighter. The F-15 was delivered into service in the late 1970s and remained in service with the USAF for over twenty years. The F-15 was successful in achieving air superiority through the use of avionics, weapons, speed, and maneuverability. Its electronic systems and weaponry could detect, track, and attack enemy aircraft while the flight control systems would allow one person to effectively perform air-to-air combat. E-flite has replicated the F-15 Eagle as a sport, scale model. This military fighter model boasts the scale Edwards Air Force Base Safety Chase trim scheme, making it a very attractive and highly visible plane. Spend less time building and more time flying, as this model comes out of the box fully painted red and silver on white foam with custom decals applied. It even includes retracts.

This high-powered model was designed around the use of two 420 DF 3800Kv motors to match with the included ducted fan units. The low wing loading and twin ducted fans allow superior maneuverability and acceleration to perform basic aerobatics. While this plane is capable of flying a tight flight pattern, it can still be flown at your local park. The wings are each reinforced with a carbon fiber tube spar for added stability. This model also has full flying horizontal stabilizers for pitch control and stability. The flight characteristics and response of E-flite's F-15 Eagle mirror those of the full-size McDonnell Douglas Eagle, down to the aerobatic capabilities. This model was created for the ambitious sport scale, advanced pilot looking for a versatile model capable of park flying.

## Contents of Kit/Parts Layout

### Large Parts:

EFL7051	Wing Set
EFL7052	Fuselage
EFL7053	Main Hatch
EFL7054	Horizontal Stab Set
EFL7055	Vertical Fin Set
EFL7056	Power Hatch
EFL7057	Landing Gear Set
EFL7058	Wheel Set
EFL7059	Pushrod Set
EFL7060	Canopy
EFL7061	Decal Set
EFL7062	Retracts



## Required Radio Equipment

You will need a minimum 4-channel transmitter, crystals, receiver, and five sub-micro servos. You can choose to purchase a complete radio system. If you are using an existing transmitter, just purchase the other required equipment separately. We recommend the crystal-free, interference-free Spektrum™ DX6i 2.4GHz DSM® 6-channel system. If using your own transmitter, we recommend the E-flite® S75 Sub-Micro Servos.

If you own the Spektrum DX6i radio, just add the AR6100E DSM2™ 6-channel receiver and five (to eight) of our E-flite S75 Sub-Micro Servos.

### Complete Radio System

SPM6600                      DX6i DSM 6CH system

### Or

SPMAR6100E                AR6100E DSM2 6-Channel Receiver  
Ultralite (for DX6i or DX7)

### And

EFLRS75                      7.5-gram Sub-Micro Servo (5–8)  
(if using retracts)  
EFLREX12L                  12-inch Servo Extension, Lightweight (2)  
(Optional retracts)  
EFLREX18L                  18-inch Servo Extension, Lightweight (3)  
EFLRYH3                      3-inch Y-Harness, Lightweight  
(3 required, 4 when installing retracts)

## Motor Setup

EFLM1340DF                420 Ducted Fan Brushless Outrunner,  
3800Kv (2 required)  
EFLA312b                    40-amp Brushless ESC (2 required)  
EFLB21003S                2100mAh 3-Cell 11.1V Li-Po (2 required)

## Required Tools and Adhesives

---

### Tools & Equipment

EFLA250 Park Flyer Tool Assortment, 5-piece

### Or Purchase Separately

EFLA257 Screwdriver, #1 and #2 Phillips  
(or included with EFLA250)

Hex wrench: 1.5mm	6-minute epoxy
Hobby knife	Clear tape
Phillips screwdriver: #1	Hobby knife
Side cutters	String
Painter's tape	Canopy glue
Ruler	Threadlock
Rotary tool with sanding drum and high speed grinding bit	

## Optional Accessories

---

EFLA110	Power Meter
EFLC3005	Celectra™ 1- to 3-Cell Li-Po Charger
EFLC505	Intelligent 1- to 5-Cell Balancing Charger
THP21003SPL	2100mAh 3S 11.1V Li-Po Battery

## Using the Manual

---

This manual is divided into sections to help make assembly easier to understand, and to provide breaks between each major section. In addition, check boxes have been placed next to each step to keep track of each step completed. Steps with a single circle (○) are performed once, while steps with two circles (○ ○) indicate that the step will require repeating, such as for a right or left wing panel, two servos, etc.

Remember to take your time and follow the directions.

## Warranty Information

---

### Warranty Period

---

Horizon Hobby, Inc., (Horizon) warrants that the Products purchased (the "Product") will be free from defects in materials and workmanship at the date of purchase by the Purchaser.

### Limited Warranty

---

(a) This warranty is limited to the original Purchaser ("Purchaser") and is not transferable. REPAIR OR REPLACEMENT AS PROVIDED UNDER THIS WARRANTY IS THE EXCLUSIVE REMEDY OF THE PURCHASER. This warranty covers only those Products purchased from an authorized Horizon dealer. Third party transactions are not covered by this warranty. Proof of purchase is required for warranty claims. Further, Horizon reserves the right to change or modify this warranty without notice and disclaims all other warranties, express or implied.

(b) Limitations- HORIZON MAKES NO WARRANTY OR REPRESENTATION, EXPRESS OR IMPLIED, ABOUT NON-INFRINGEMENT, MERCHANTABILITY OR FITNESS FOR A PARTICULAR PURPOSE OF THE PRODUCT. THE PURCHASER ACKNOWLEDGES THAT THEY ALONE HAVE DETERMINED THAT THE PRODUCT WILL SUITABLY MEET THE REQUIREMENTS OF THE PURCHASER'S INTENDED USE.

(c) Purchaser Remedy- Horizon's sole obligation hereunder shall be that Horizon will, at its option, (i) repair or (ii) replace, any Product determined by Horizon to be defective. In the event of a defect, these are the Purchaser's exclusive remedies. Horizon reserves the right to inspect any and all equipment involved in a warranty claim. Repair or replacement decisions are at the sole discretion of Horizon. This warranty does not cover cosmetic damage or damage due to acts of God, accident, misuse, abuse, negligence, commercial use, or modification of or to any part of the Product. This warranty does not cover damage due to improper installation, operation, maintenance, or attempted repair by anyone other than Horizon. Return of any goods by Purchaser must be approved in writing by Horizon before shipment.

## Damage Limits

---

HORIZON SHALL NOT BE LIABLE FOR SPECIAL, INDIRECT OR CONSEQUENTIAL DAMAGES, LOSS OF PROFITS OR PRODUCTION OR COMMERCIAL LOSS IN ANY WAY CONNECTED WITH THE PRODUCT, WHETHER SUCH CLAIM IS BASED IN CONTRACT, WARRANTY, NEGLIGENCE, OR STRICT LIABILITY. Further, in no event shall the liability of Horizon exceed the individual price of the Product on which liability is asserted. As Horizon has no control over use, setup, final assembly, modification or misuse, no liability shall be assumed nor accepted for any resulting damage or injury. By the act of use, setup or assembly, the user accepts all resulting liability.

If you as the Purchaser or user are not prepared to accept the liability associated with the use of this Product, you are advised to return this Product immediately in new and unused condition to the place of purchase.

Law: These Terms are governed by Illinois law (without regard to conflict of law principals).

## Safety Precautions

---

This is a sophisticated hobby Product and not a toy. It must be operated with caution and common sense and requires some basic mechanical ability. Failure to operate this Product in a safe and responsible manner could result in injury or damage to the Product or other property. This Product is not intended for use by children without direct adult supervision. The Product manual contains instructions for safety, operation and maintenance. It is essential to read and follow all the instructions and warnings in the manual, prior to assembly, setup or use, in order to operate correctly and avoid damage or injury.

## Questions, Assistance, and Repairs

---

Your local hobby store and/or place of purchase cannot provide warranty support or repair. Once assembly, setup or use of the Product has been started, you must contact Horizon directly. This will enable Horizon to better answer your questions and service you in the event that you may need any assistance. For questions or assistance, please direct your email to [productsupport@horizonhobby.com](mailto:productsupport@horizonhobby.com), or call 877.504.0233 toll free to speak to a service technician.

## Inspection or Repairs

---

If this Product needs to be inspected or repaired, please call for a Return Merchandise Authorization (RMA). Pack the Product securely using a shipping carton. Please note that original boxes may be included, but are not designed to withstand the rigors of shipping without additional protection. Ship via a carrier that provides tracking and insurance for lost or damaged parcels, as **Horizon is not responsible for merchandise until it arrives and is accepted at our facility**. A Service Repair Request is available at [www.horizonhobby.com](http://www.horizonhobby.com) on the "Support" tab. If you do not have internet access, please include a letter with your complete name, street address, email address and phone number where you can be reached during business days, your RMA number, a list of the included items, method of payment for any non-warranty expenses and a brief summary of the problem. Your original sales receipt must also be included for warranty consideration. Be sure your name, address, and RMA number are clearly written on the outside of the shipping carton.

## Warranty Inspection and Repairs

---

**To receive warranty service, you must include your original sales receipt** verifying the proof-of-purchase date. Provided warranty conditions have been met, your Product will be repaired or replaced free of charge. Repair or replacement decisions are at the sole discretion of Horizon Hobby.

## Non-Warranty Repairs

---

***Should your repair not be covered by warranty the repair will be completed and payment will be required without notification or estimate of the expense unless the expense exceeds 50% of the retail purchase cost.*** By submitting the item for repair you are agreeing to payment of the repair without notification. Repair estimates are available upon request. You must include this request with your repair. Non-warranty repair estimates will be billed a minimum of ½ hour of labor. In addition you will be billed for return freight. Please advise us of your preferred method of payment. Horizon accepts money orders and cashiers checks, as well as Visa, MasterCard, American Express, and Discover cards. If you choose to pay by credit card, please include your credit card number and expiration date. Any repair left unpaid or unclaimed after 90 days will be considered abandoned and will be disposed of accordingly. ***Please note: non-warranty repair is only available on electronics and model engines.***

Electronics and engines requiring inspection or repair should be shipped to the following address:

Horizon Service Center  
4105 Fieldstone Road  
Champaign, Illinois 61822

All other Products requiring warranty inspection or repair should be shipped to the following address:

Horizon Product Support  
4105 Fieldstone Road  
Champaign, Illinois 61822

***Please call 877-504-0233 with any questions or concerns regarding this product or warranty.***

## Note on Lithium Polymer Batteries

---



Lithium Polymer batteries are significantly more volatile than alkaline or Ni-Cd/Ni-MH batteries used in RC applications. All manufacturer's instructions and warnings must be followed closely. Mishandling of Li-Po batteries can result in fire. Always follow the manufacturer's instructions when disposing of Lithium Polymer batteries.

## Warning

---

An RC aircraft is not a toy! If misused, it can cause serious bodily harm and damage to property. Fly only in open areas, preferably at AMA (Academy of Model Aeronautics) approved flying sites, following all instructions included with your radio.

Keep loose items that can get entangled in the propeller away from the prop, including loose clothing, or other objects such as pencils and screwdrivers. Especially keep your hands away from the propeller.

## Safety, Precautions and Warnings

As the user of this product, you are solely responsible for operating it in a manner that does not endanger yourself and others or result in damage to the product or the property of others.

Carefully follow the directions and warnings for this and any optional support equipment (chargers, rechargeable battery packs, etc.) that you use.

This model is controlled by a radio signal that is subject to interference from many sources outside your control. This interference can cause momentary loss of control so it is necessary to always keep a safe distance in all directions around your model, as this margin will help to avoid collisions or injury.

- Always operate your model in an open area away from cars, traffic, or people.
- Avoid operating your model in the street where injury or damage can occur.
- Never operate the model out into the street or populated areas for any reason.
- Never operate your model with low transmitter batteries.
- Carefully follow the directions and warnings for this and any optional support equipment (chargers, rechargeable battery packs, etc.) that you use.
- Keep all chemicals, small parts and anything electrical out of the reach of children.
- Moisture causes damage to electronics. Avoid water exposure to all equipment not specifically designed and protected for this purpose.

## Stabilator Installation

### Required Parts

Servo (2)	Stabilator (right and left)
Pushrod connector (2)	145mm pushrod w/ball end (2)
Nylon nut (2)	Control ball end w/setscrew (2)

### Required Tools and Adhesives

Hex wrench: 1.5mm	6-minute epoxy
Hobby knife	Threadlock

1. Remove the servo horn from the servo. Use 6-minute epoxy to glue the elevator servo in position in the fuselage.



- ○ 2. Locate the stabilator and look at the rod of the stabilizer. You will note that one side of the control rod has a flat area ground onto the rod. This will face to the top of the fuselage when the stabilator is installed.

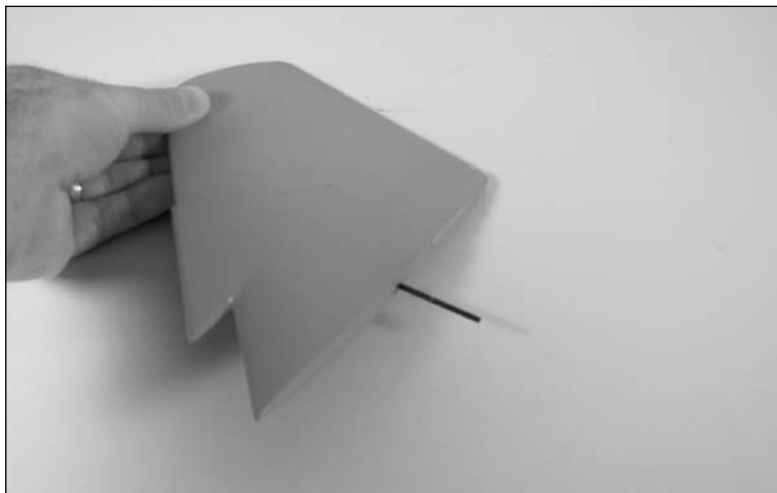

- ○ 3. Slide the appropriate stabilator into the bushing in the fuselage. As you slide the stabilator in position, slide it into one of the control ball ends.



- ○ 4. Once the stabilator is positioned, rotate it so the setscrew can be accessed. After applying a drop of threadlock on the setscrew, use a 1.5mm hex wrench to tighten the setscrew onto the flat of the control rod.

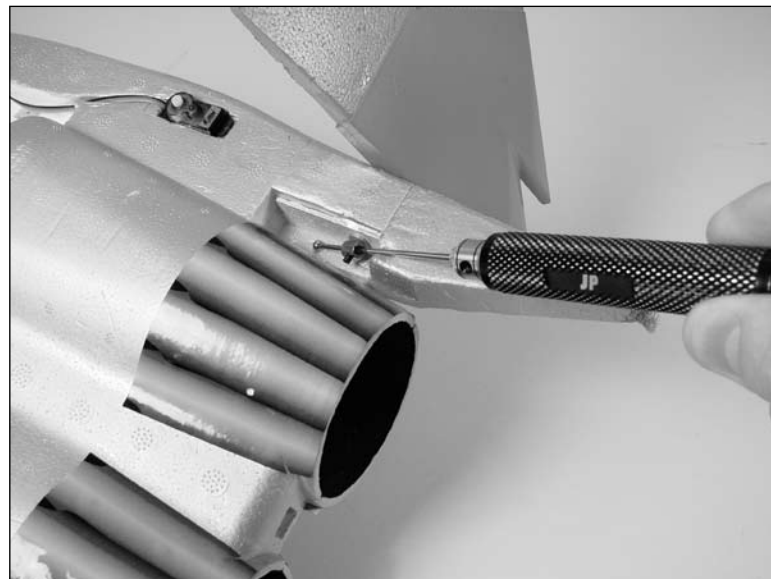

- ○ 5. Use a hobby knife to enlarge the outer hole of a servo arm. Install the pushrod connector and secure it, using the nylon nut supplied with your model.

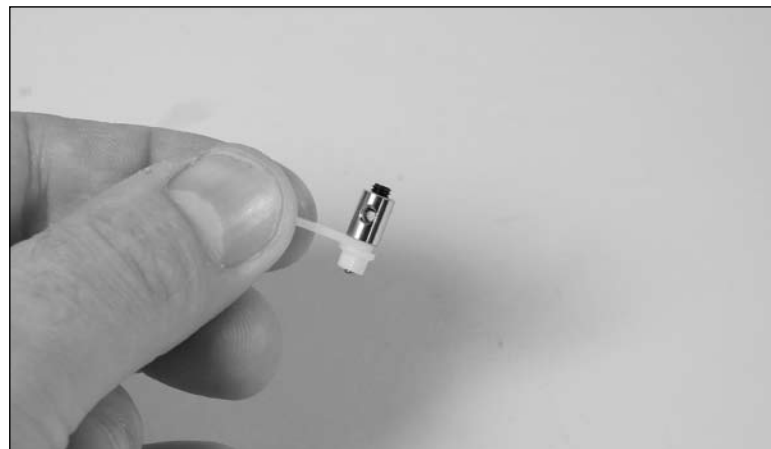



- 6. Snap the ball link on the 145mm pushrod onto the stabilizer control ball end.

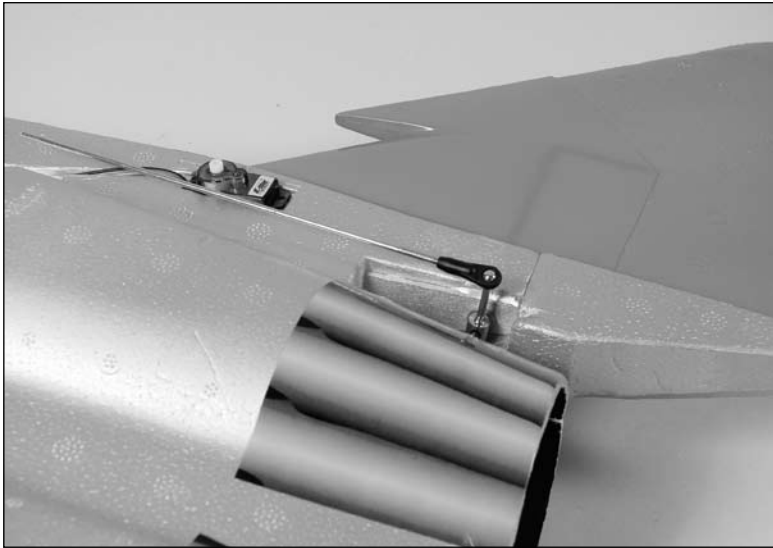

- 7. Slide the pushrod connector onto the pushrod wire. After centering the elevator servo using the radio, install the servo arm on the elevator servo. Make a small bend in the pushrod to ensure the pushrod is straight and in line with the control arm.

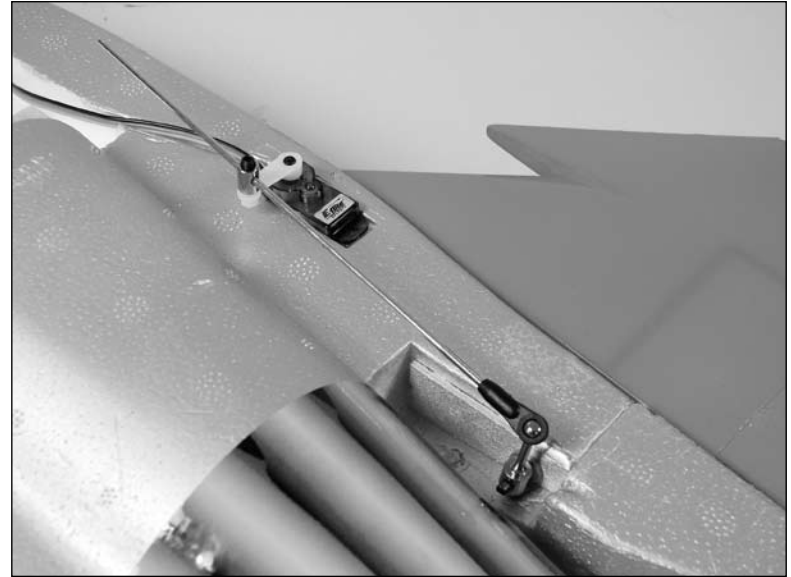

- ○ 8. With the radio system on, center the stabilator using the guide on the side of the fuselage. Tighten the setscrew to secure the pushrod wire to the elevator servo. Make sure to use threadlock on the setscrew to prevent it from vibrating loose.

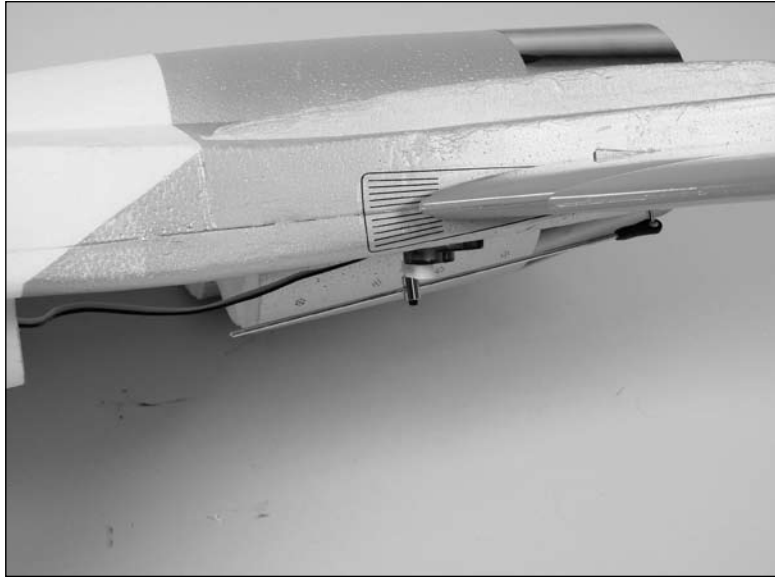

- 9. Repeat Steps 1 through 8 to install the remaining elevator servo. Make note that the pushrod is bent slightly and the servo arms of both elevator servos face the same direction. This will make both stabilators operate in the same direction without the need to use mixing at the radio.

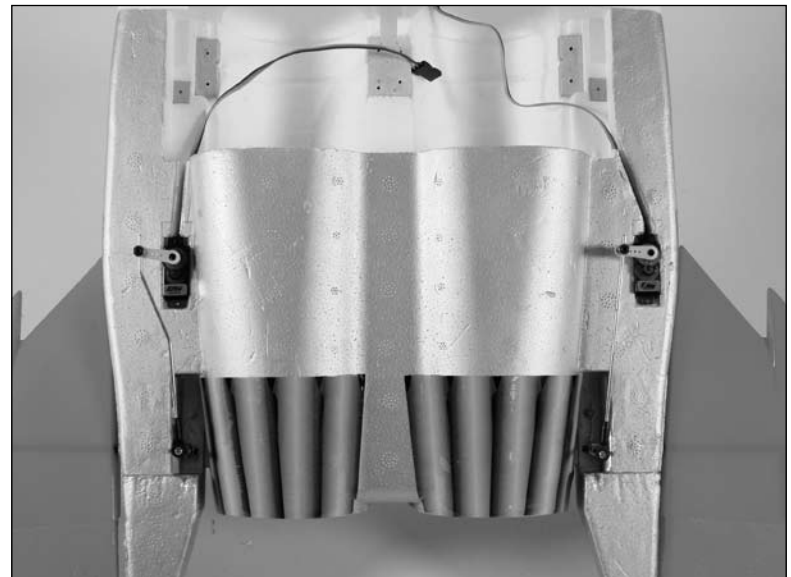
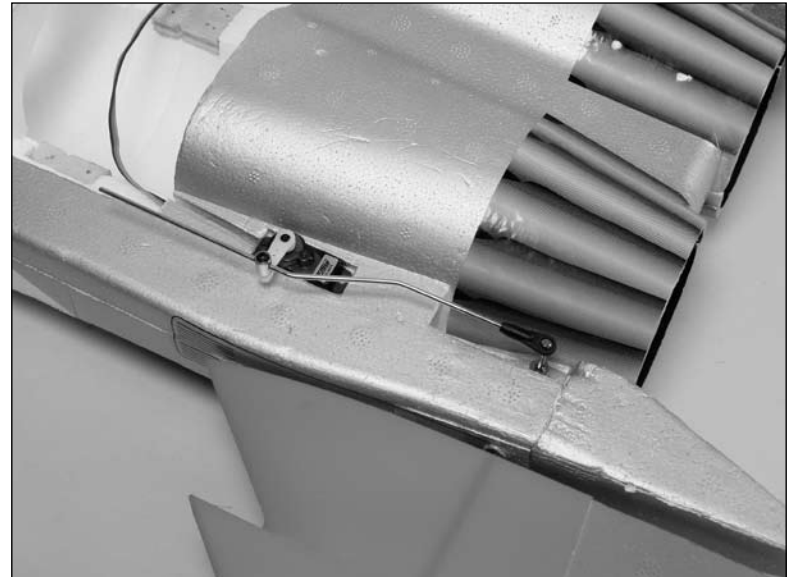

# Motor and Fan Installation

## Required Parts

Impeller (2)	Impeller shaft (2)
Impeller shaft nut (2)	Fan housing (2)
Motor w/connectors(2)	Speed control w/connectors (2)
Fan cover	2mm x 8mm sheet metal screw (8)
18-inch extension	Y-harness
Servo (2)	2mm x 6mm machine screw (2)
2mm x 22mm sheet metal screw (2)	

## Required Tools and Adhesives

Hex wrench: 1.5mm	Phillips screwdriver: #1
Clear tape	Threadlock
Soldering iron	Solder
Hook and loop tape	String
Rotary tool with high speed grind bit and fine drum sander	

**Note:** There is minimal airflow through the center of the fuselage for ESC cooling. For this reason we have gone to a larger amperage ESC than is really necessary. We use the E-flite 40-amp ESC and have had no issues with this setup in any of our test models.

- 1. Slide the impeller shaft onto the impeller.

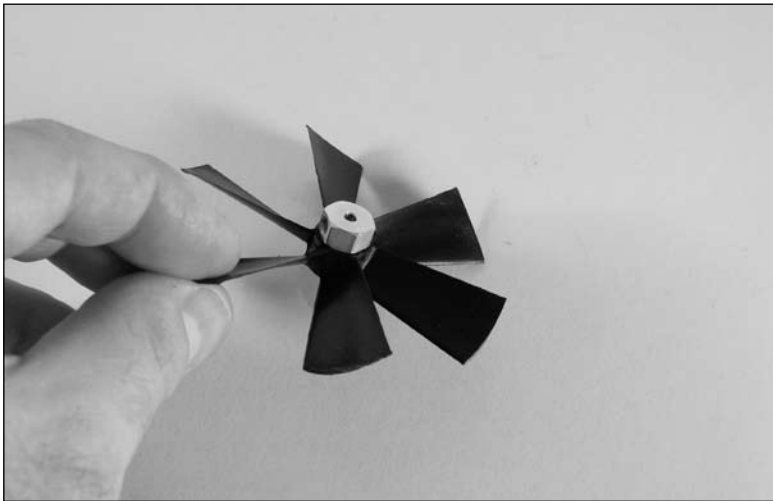

- 2. Use the impeller nut to secure the impeller shaft to the impeller. Do not tighten at this time.

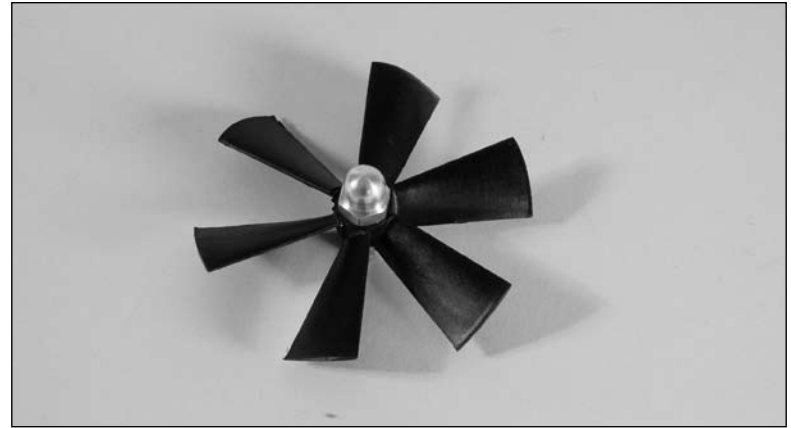

- 3. Use two 2mm x 6mm machine screws and a #1 Phillips screwdriver to secure the motor in the fan housing. Route the motor leads to the outside of the shroud as shown.



**Note:** You might have to grind a small hole in the shroud to accommodate your motor leads.

- ○ 4. Secure the impeller to the motor shaft using a 1.5mm hex wrench and setscrew. Be sure to use threadlock when installing the setscrew.



- ○ 5. Solder the appropriate connector to the motor leads to connect the motor to your particular speed control. Also install the appropriate connector to the speed control to connect the motor battery.

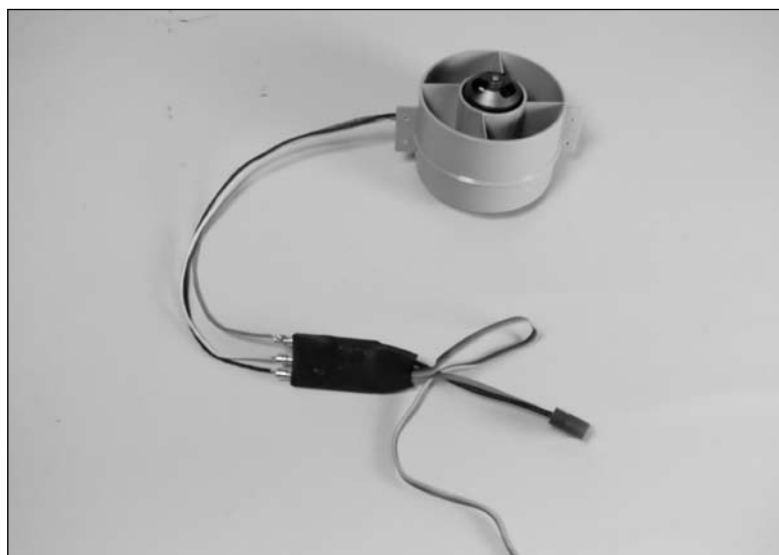

- ○ 6. You can check the operation of the motor at this time. Be very careful that you do not encounter the impeller when checking the operation of the fan. If any rubbing occurs, you can remove the fan rotor assembly and work the area with a rotary tool and a fine drum sander until all the black area is removed. Remove very little, maintaining the circumference of the shroud. Reinstall the impeller and run again. There should be no rubbing at all during operation.
- ○ 7. Slide the speed control into the opening between the fan tunnels and into the main fuselage.

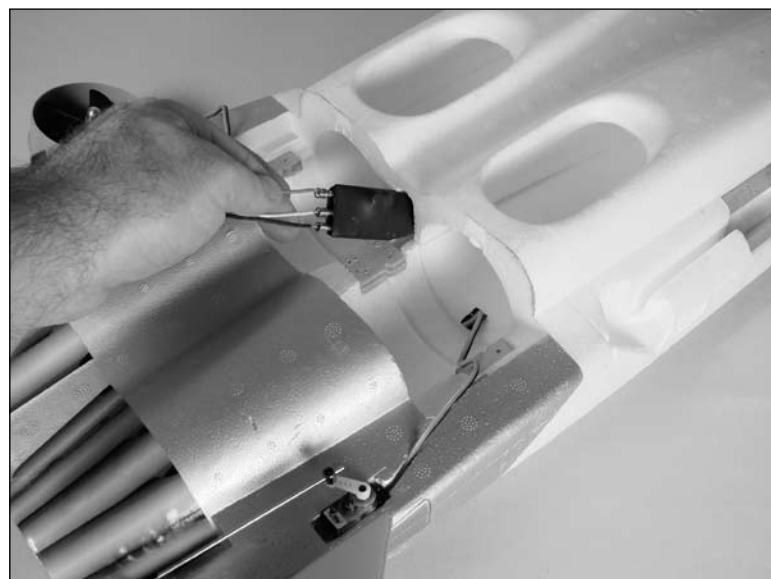

- ○ 8. Secure the fan to the fuselage using four 2mm x 8mm sheet metal screws and a #1 Phillips screwdriver.

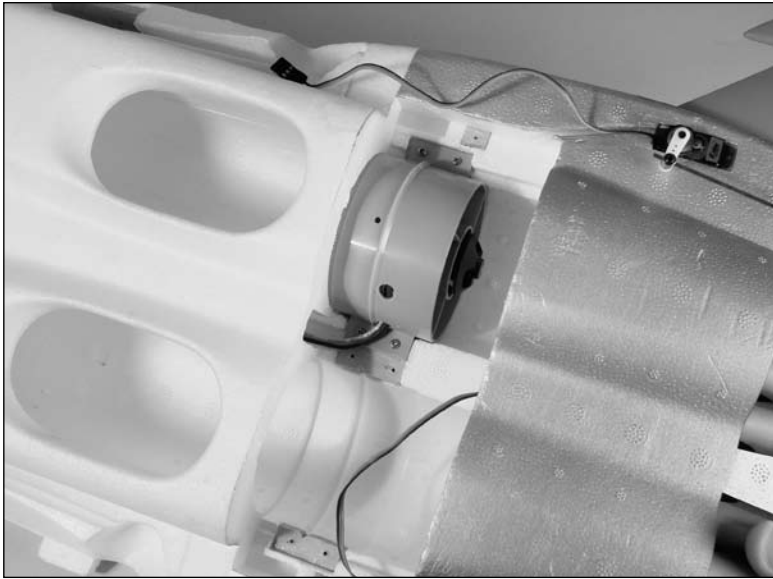

- ○ 9. Secure the speed control to the side of the fuselage using hook and loop tape.

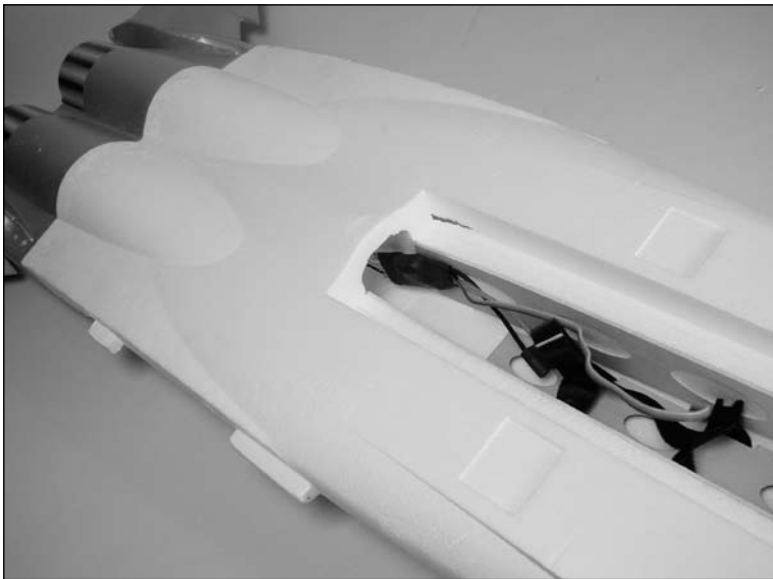

- 10. Repeat Steps 1 through 9 to install the remaining fan assembly in the fuselage.

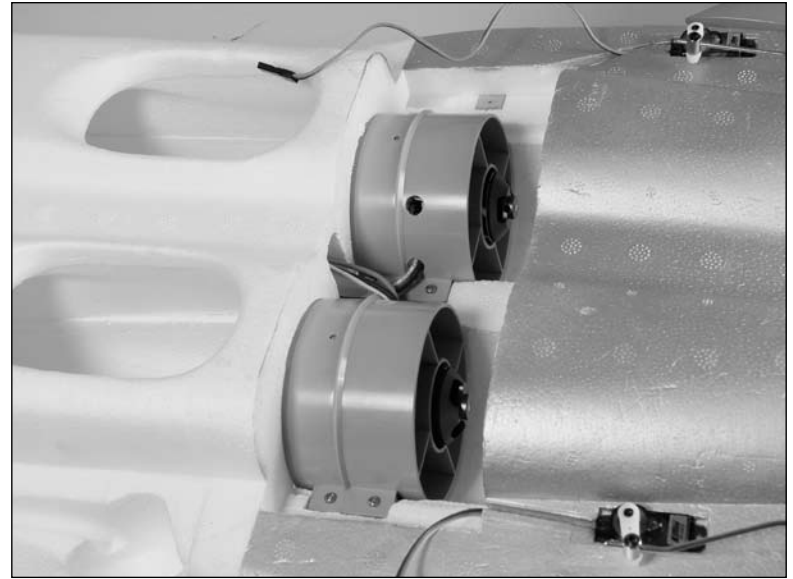

- 11. Secure a lightweight Y-harness to a lightweight 18-inch (457mm) servo extension.



- 12. Secure the elevator servos to the Y-harness using string or a commercially available connector.

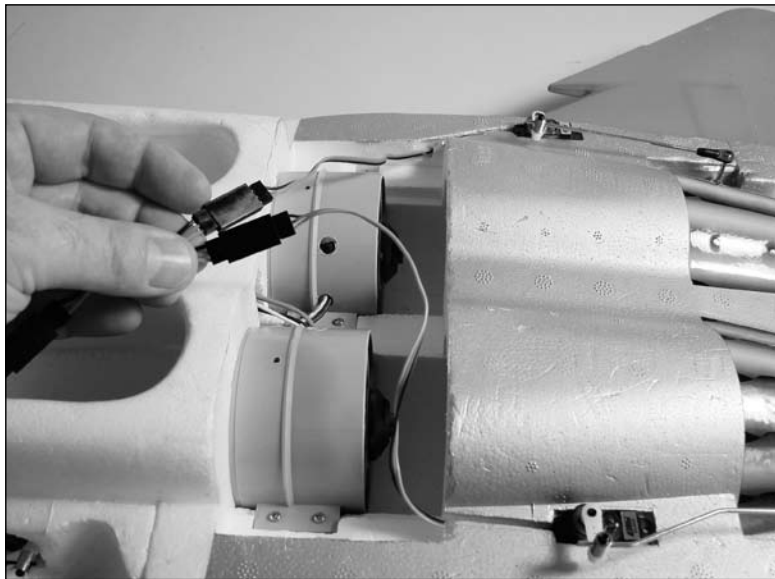

- 13. Slide the servo extension into the opening between the fan tunnels at this time.

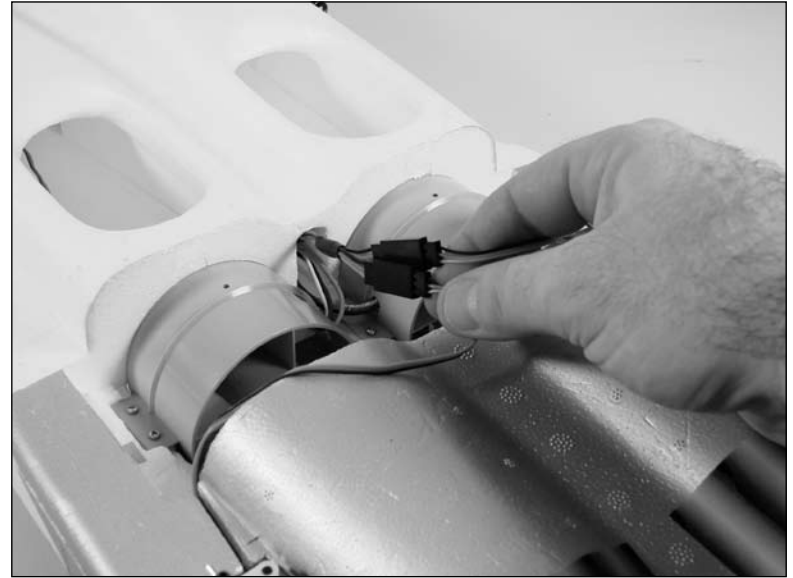

- 14. Use clear tape to secure the elevator servo leads to the fan shroud. This will prevent the wiring from interfering with the operation of the fans.

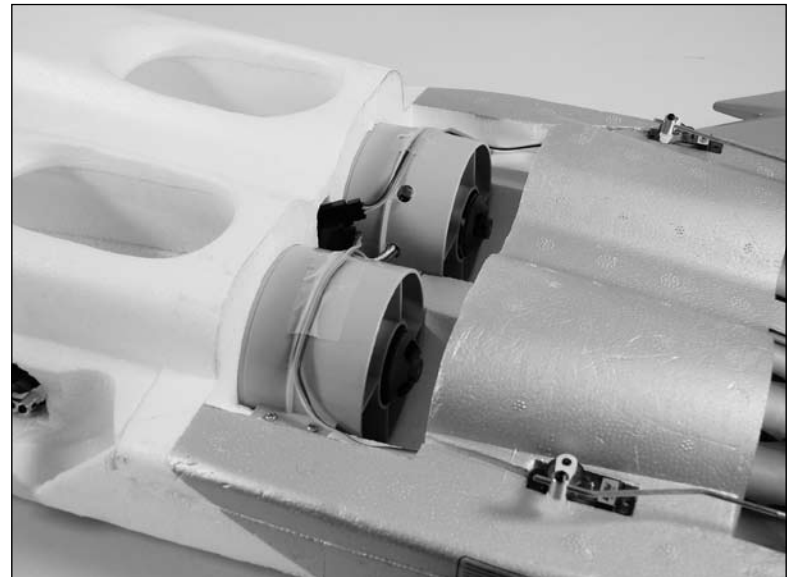

- 15. Secure the fan cover in position using two 2mm x 22mm sheet metal screws and a #1 Phillips screwdriver.

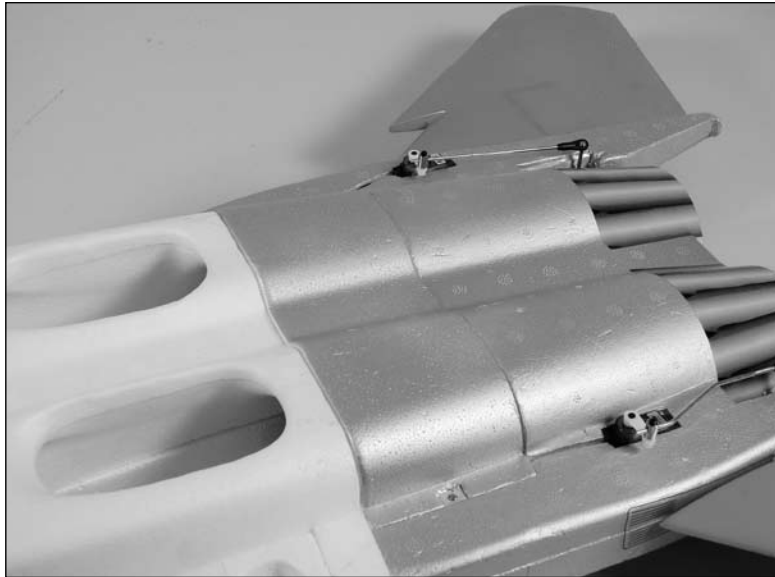

**Note:** You might have to remove a small amount of foam from the inside area of the Power Hatch to allow the hatch to fit down nice and tight. This is due to the wires from the stab servos running through this area.

## Fixed Gear Installation

### Required Parts

Main gear (right and left)	Nose gear
Wheel (3)	Spring washer (3)
Servo w/hardware	2mm x 8mm sheet metal screw (12)
Pushrod connector	Nylon nut
185mm pushrod wire w/clevis	

### Required Tools and Adhesives

Hex wrench: 1.5mm	Phillips screwdriver: #1
Threadlock	Hobby knife
Side cutters	

- 1. Secure the main gear in the fuselage using four 2mm x 8mm sheet metal screws and a #1 Phillips screwdriver. The gear face toward the front of the fuselage.

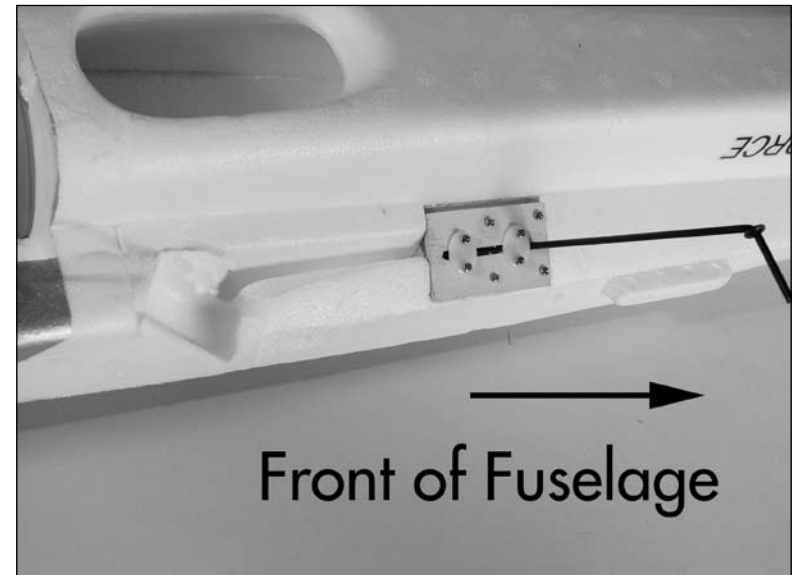

- ○ 2. Slide the wheel onto the gear. Press a spring washer onto the wire to secure the wheel.



- 3. Repeat Steps 1 and 2 to install the opposite main landing gear.

- 4. Locate the 185mm pushrod wire. Attach the clevis to the steering arm on the nose gear as shown. Slide the tubing on the clevis to prevent the clevis from opening during flight.

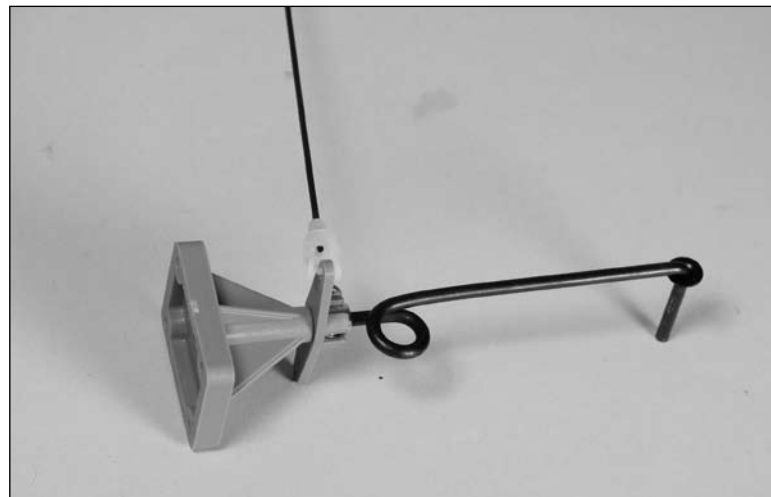

- 5. Use four 2mm x 8mm sheet metal screws and a #1 Phillips screwdriver to secure the nose gear. Note that the spring for the gear faces to the aft of the fuselage.





- 6. Slide the wheel onto the gear. Press a spring washer onto the wire to secure the wheel.

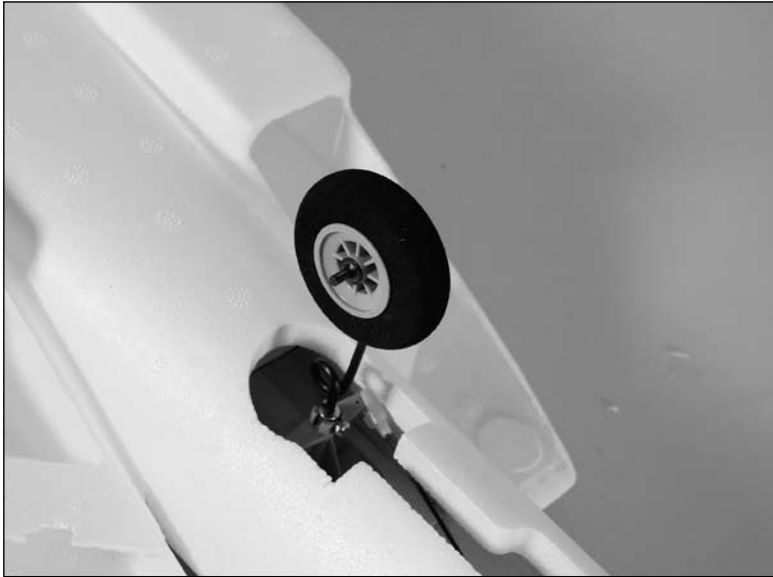

- 7. Use a #1 Phillips screwdriver and the screws provided with the servo to secure it in the fuselage. Make sure to slide the servo as far to the side of the fuselage as shown.

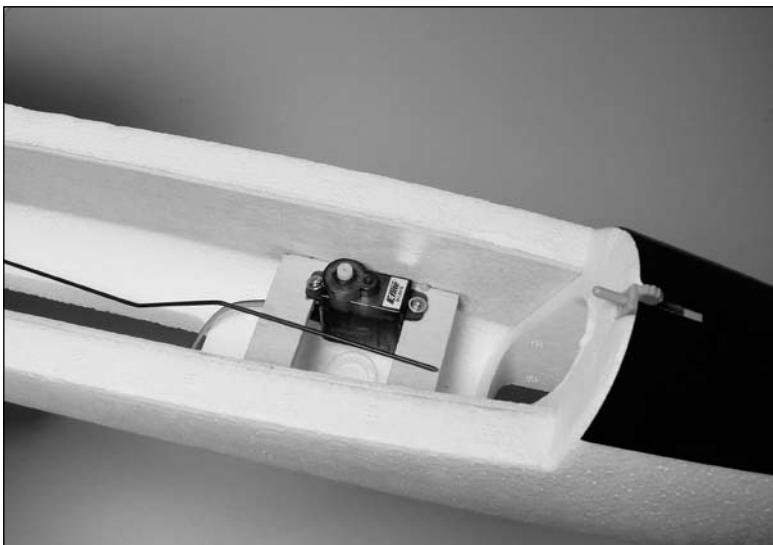

- 8. Use side cutters to remove the outer hole from the servo arm. This is done in case you will be installing retracts later in the life of your model.

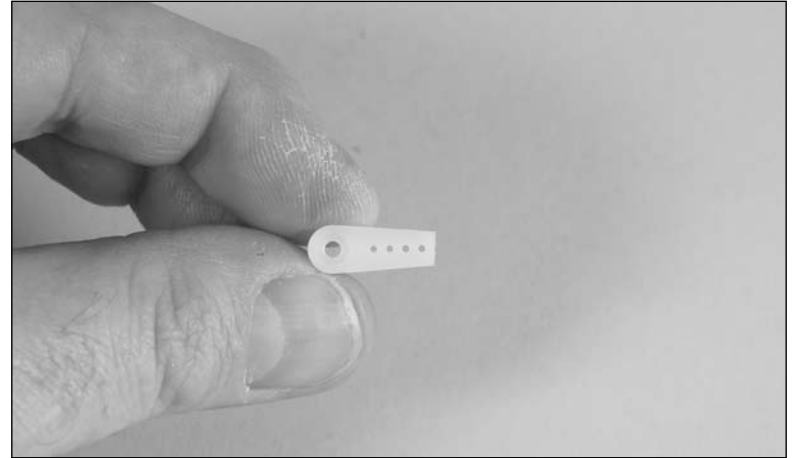

- 9. Use a hobby knife to enlarge the outer hole of a servo arm. Install the pushrod connector and secure it using the nylon nut supplied with your model.

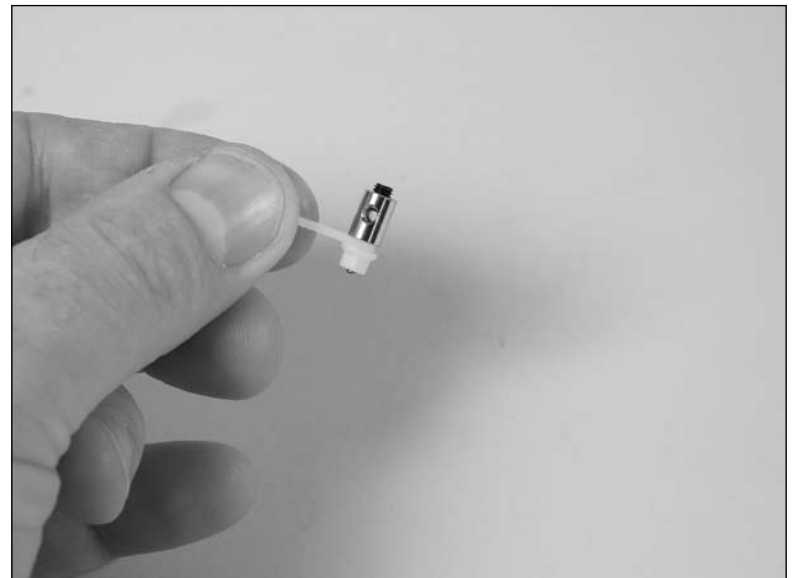

- 10. Slide the pushrod connector onto the pushrod wire. After centering the steering servo using the radio, install the servo arm on the steering servo. Center the nose wheel and secure the pushrod wire using the setscrew and 1.5mm hex wrench.

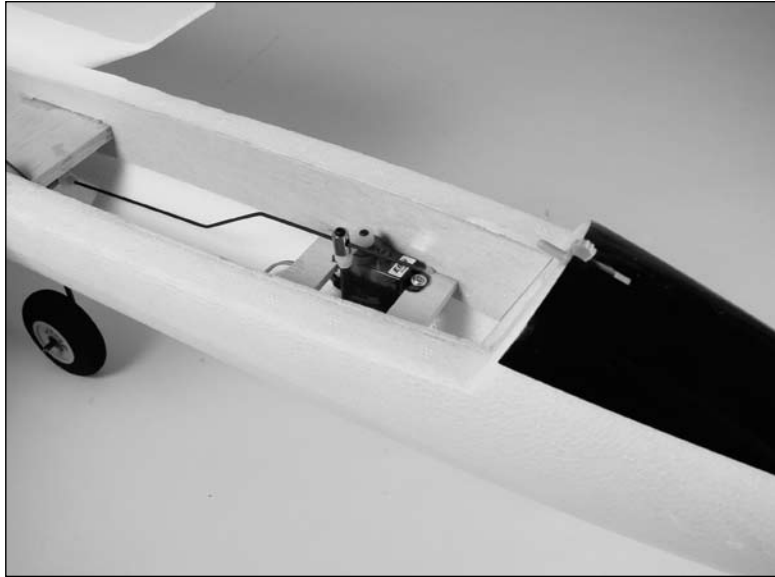

**Note:** You will need to bend the nose gear pushrod slightly to achieve the correct alignment between the servo and nose gear.

## Retract Installation

### Required Parts

Nose gear retract	Main gear retract (right and left)
Wheel (3)	Spring washer (3)
Servo w/hardware (4)	2mm x 8mm sheet metal screw (12)
Pushrod connector (4)	Nylon nut (4)
185mm pushrod wire w/clevis	127mm pushrod wire w/clevis (3)
Y-harness	

### Required Tools and Adhesives

Hex wrench: 1.5mm	Phillips screwdriver: #1
Threadlock	Hobby knife
Side cutters	

**Special note:** We use E-flite S75 servos to actuate the retracts on the F-15. Because of this we use two channels on the DX7 to actuate the retracts, channels 5 and 7. We set the endpoint adjustments on these channels and use a program mix with the Gear as the master channel and Aux 2 as the slave channel. We reverse the Aux 2 channel to be sure it goes in the correct direction. Using a Y-harness between the nose retract servo and one of the main gear retract servos will enable you to ensure correct operation of the retracts.

- ○ 1. Use a hobby knife to enlarge the outer hole of a servo arm. Install the pushrod connector and secure it using the nylon nut supplied with your model.

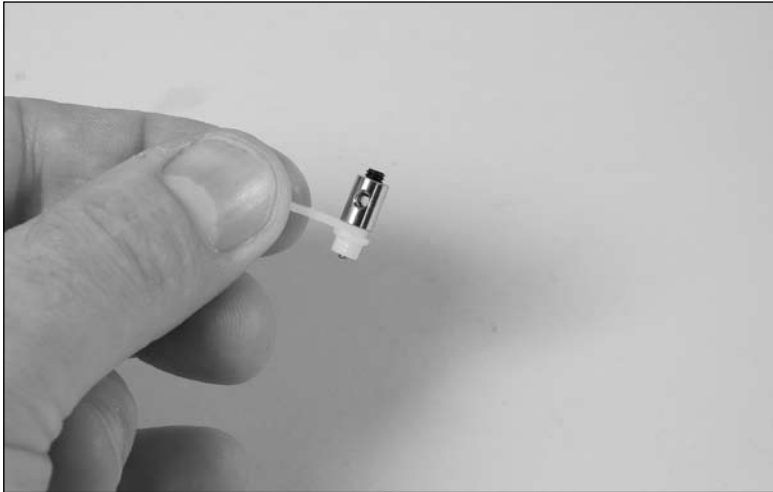

- ○ 2. Install the servo arm on the main gear retract servo. The servos shown are centered. You will want an equal amount of throw in both directions from this center position when operating the retract servos.

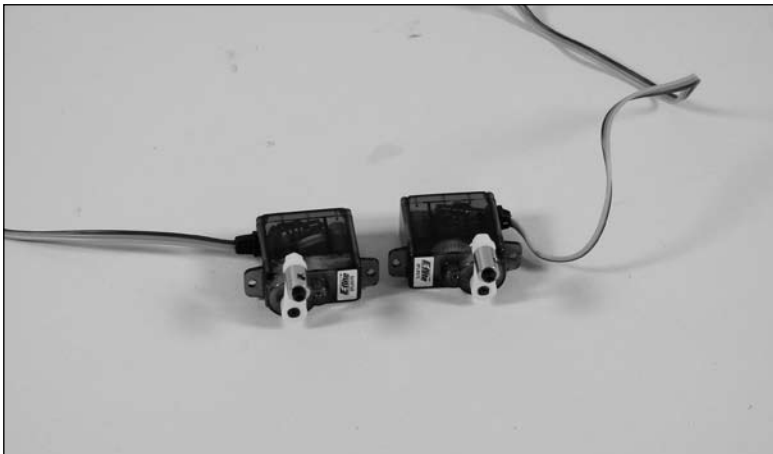

- ○ 3. Use a hobby knife to remove the material from under the rear wing alignment tab. This will provide the access necessary to cut the opening for the retract servo in the side of the fuselage.



- 4. Carefully cut a hole in the side of the fuselage to install the main gear retract servo. Make sure to allow for clearance of the servo arm.

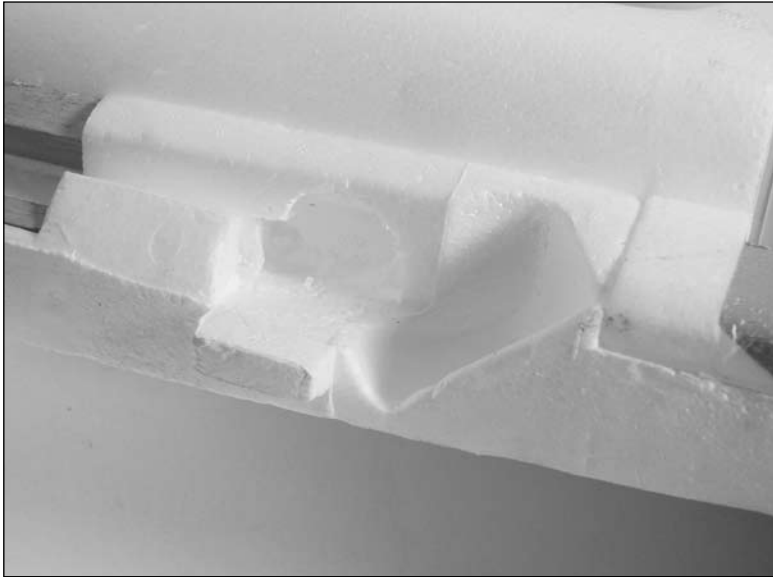

- 5. Fit the retract servo into the fuselage. It will extend into the intake as shown. Make sure the servo fits in far enough so the hole in the connector aligns with the center line of the slot for the retract gear wire. Use 6-minute epoxy to glue the servo in position.

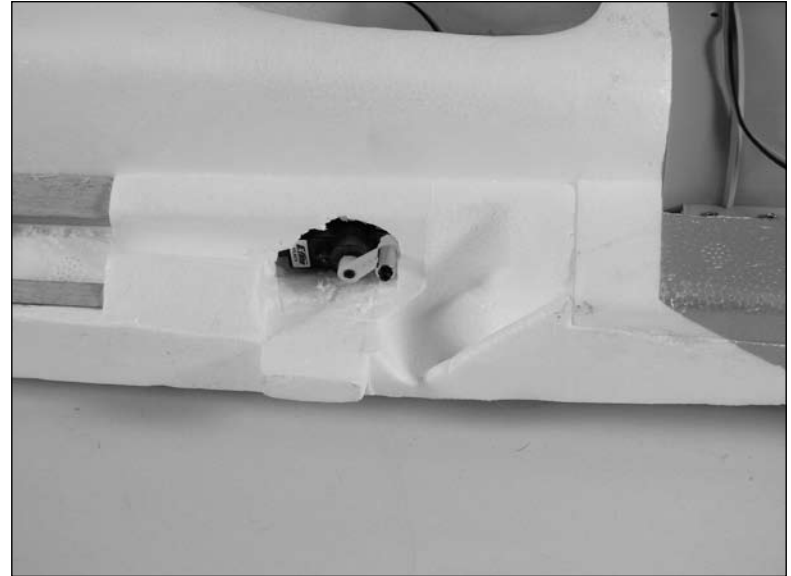

**Note:** Some early kits may need to have the retract units changed for this application. Please check your retract units with the pictures. The actuation arm should exit the same side as the gear strut wire when retracted. If so, skip to Step 8 on the following page of this manual.

- 6. Remove the three screws that hold the main gear retract together.

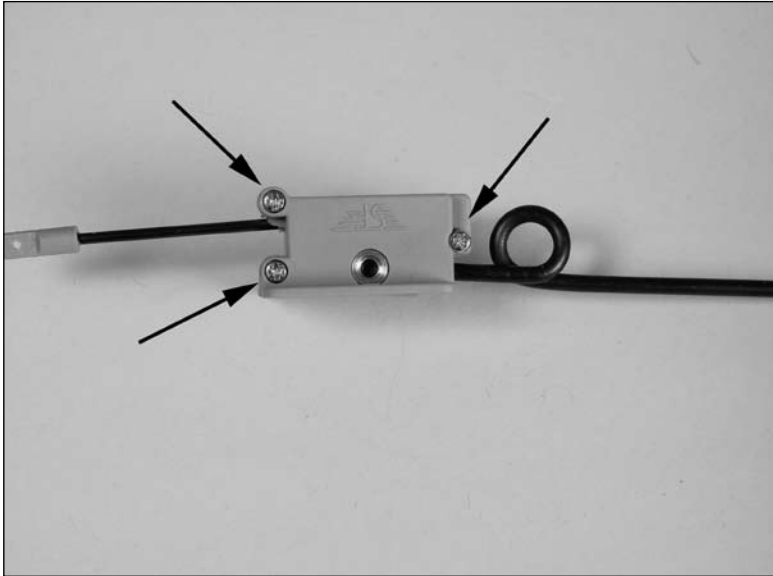

- 7. Carefully remove the actuator arm and move it so the actuator is on the same side as the gear strut. Install the screws and check that the retract moves smoothly without any binding.

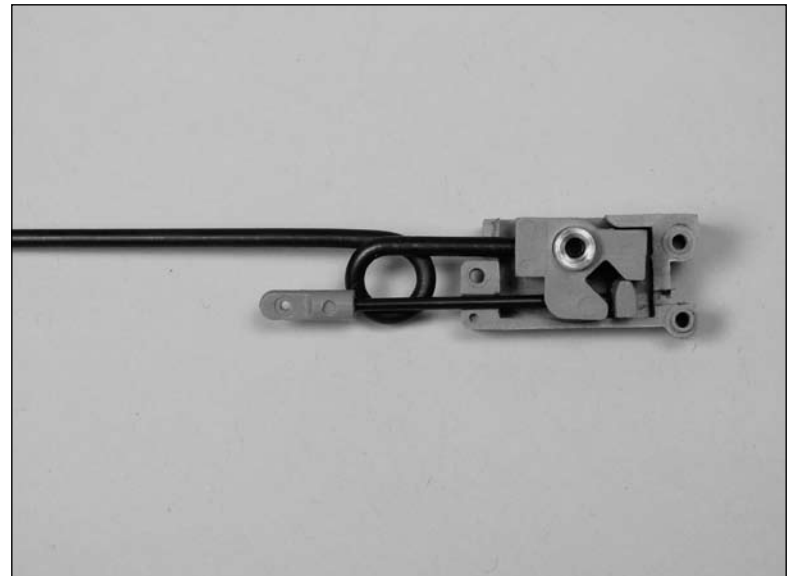
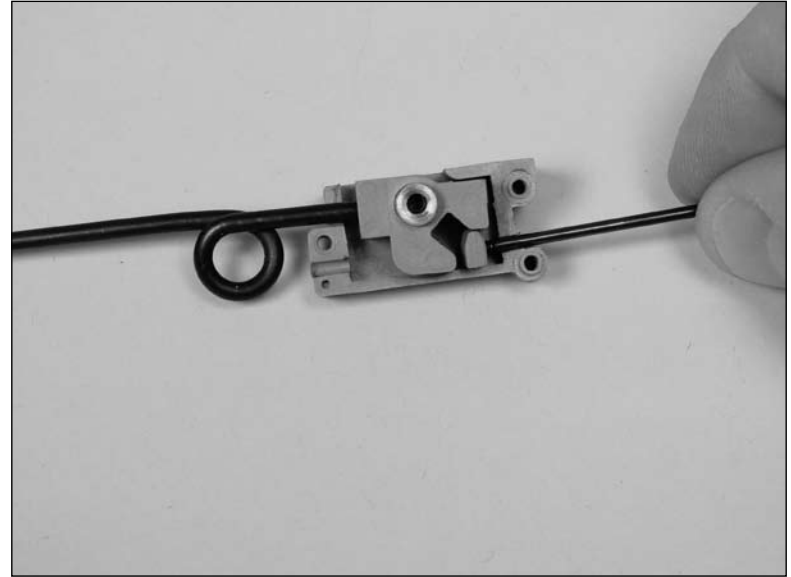

- 8. Attach the clevis from a 127mm pushrod to the retract actuator. Slide the tubing over the clevis to secure the clevis and prevent it from opening accidentally.

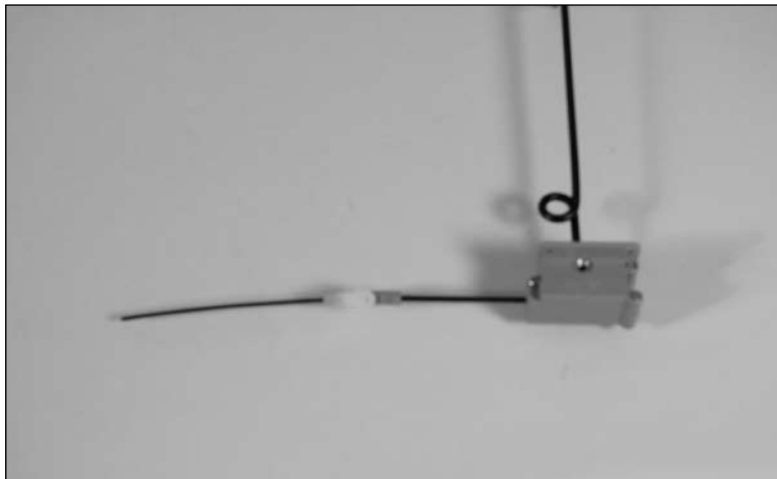

**Important:** You may need to shave the plastic retract connector on the retract actuator arm to ensure the clevis pin snaps closed.

- 9. Move the retract to the "down" position. Use the radio system to move the retract servo to the "down" position. Mark the pushrod wire against the connector. Do not tighten the setscrew at this time.

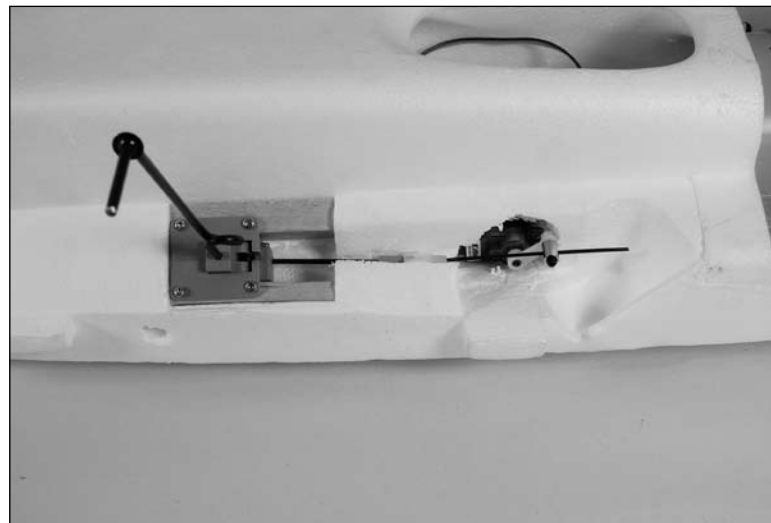

- 10. Use the radio to move the servo to the "up" position, then move the retract linkage. Check the line made on the wire to see if it is in the same location as it was in the "down" position. If not, use the end point adjustment of the radio to fine-tune the servo so the line on the pushrod is in the same position when the servo is in both the "up" and "down" positions. Once the servo has been adjusted, use a 1.5mm hex wrench to tighten the setscrew and secure the pushrod.

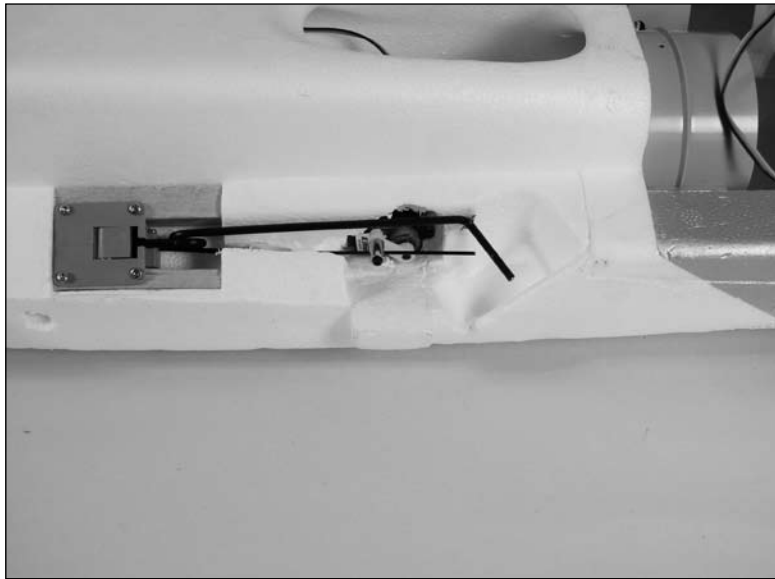

- 11. Use side cutters to cut the excess wire that may interfere with the operation of the retract.



- 12. Slide the wheel onto the gear. Press a spring washer onto the wire to secure the wheel.

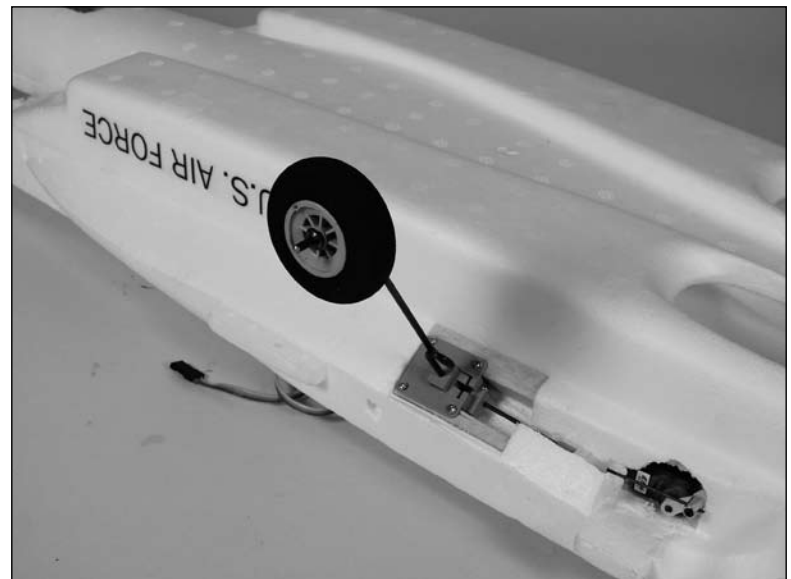

- 13. Repeat Steps 1 through 12 to install the remaining retract and servo. You will find one main retract servo to operate in conjunction with the nose gear and one main retract servo will need to be plugged into an aux channel on your radio.
- 14. Locate the 185mm pushrod wire. Attach the clevis to the steering arm on the nose gear as shown. Slide the tubing onto the clevis to prevent the clevis from opening during flight. Connect the clevis from the 127mm pushrod wire to the retract actuator.

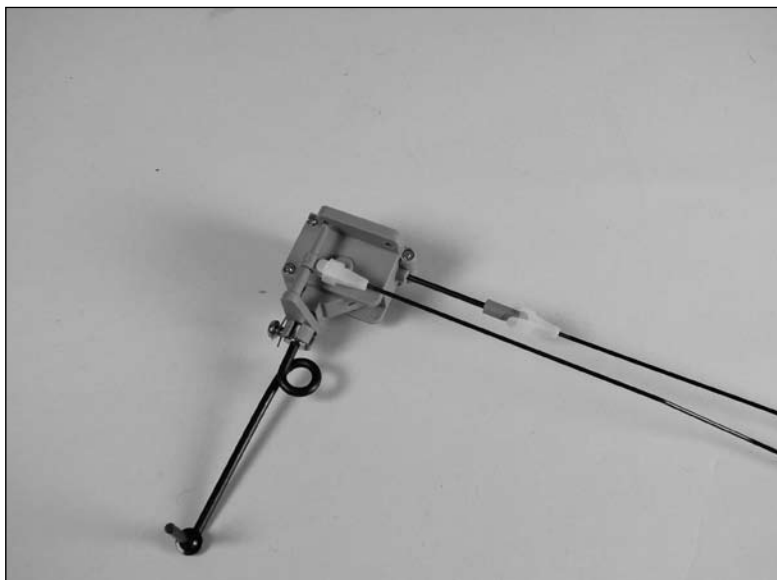

- 15. Use four 2mm x 8mm sheet metal screws and a #1 Phillips screwdriver to secure the nose gear. Note that the spring for the gear faces to the front of the fuselage. Slide the wheel onto the gear. Press a spring washer onto the wire to secure the wheel.



- 16. Use the screws provided with the servos to secure them in the fuselage. Make sure to slide the servos as far to the sides of the fuselage as shown.

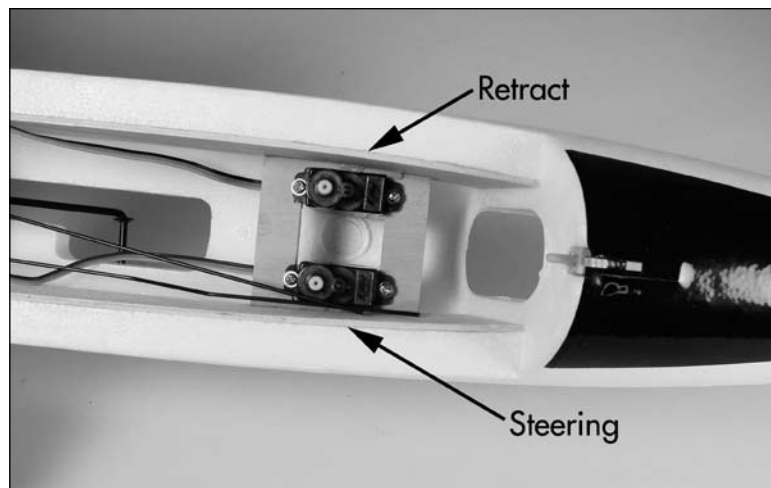



- 17. Use side cutters to remove the outer hole from the servo arm.

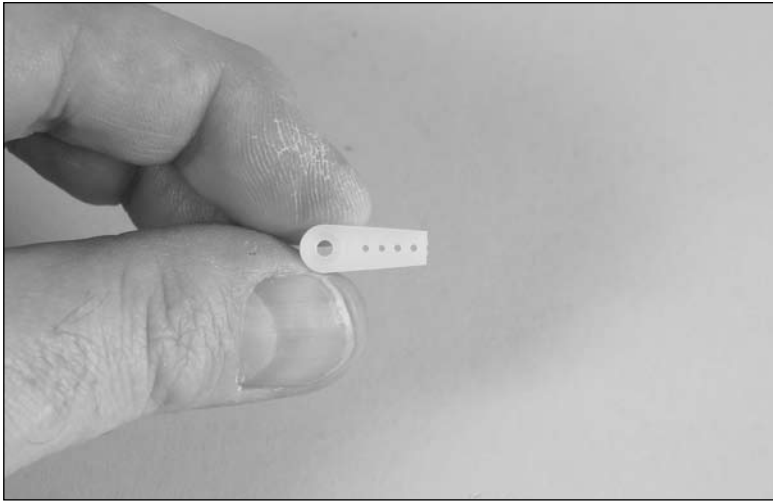

- 18. Use a hobby knife to enlarge the outer hole of a servo arm. Install the pushrod connector and secure it using the nylon nut supplied with your model.

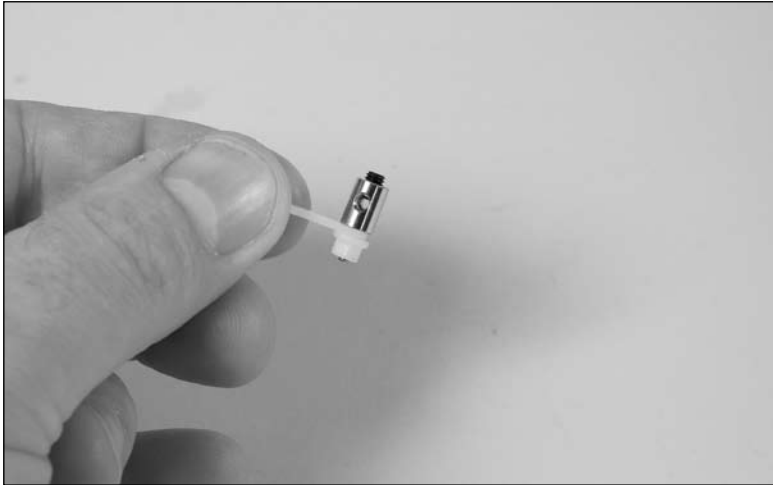

- 19. Slide the pushrod connector onto the pushrod wire. After centering the steering servo using the radio, install the servo arm on the steering servo. Center the nose wheel and secure the pushrod wire using the setscrew and 1.5mm hex wrench. Using a Y-harness, plug the nose gear retract servo into the gear channel. Repeat Steps 9, 10 and 11 to adjust the nose gear retract servo. You should find the nose retract servo will be very similar in endpoints to one of the main retract servos.

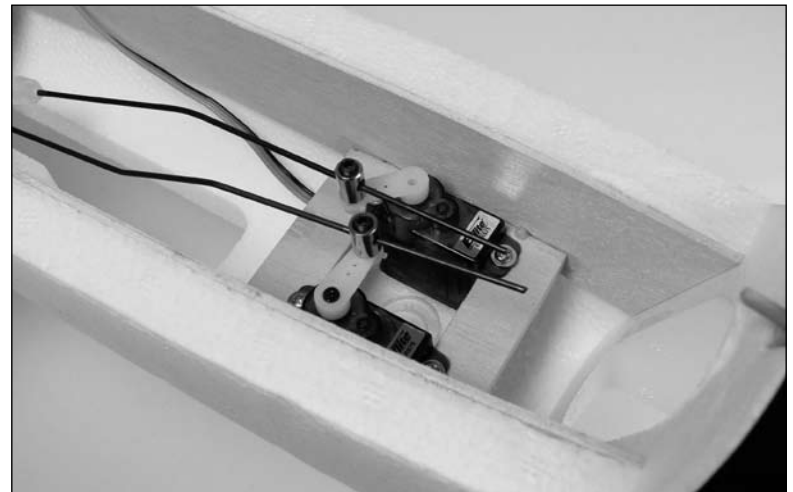
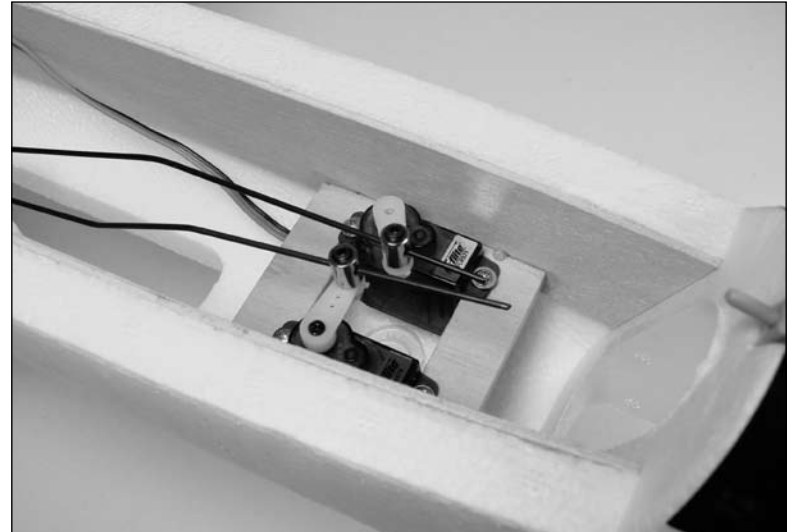

## Aileron Servo Installation

### Required Parts

Servo (2)	Wing panel (right and left)
Pushrod connector (2)	75mm pushrod w/clevis (2)
Nylon nut (2)	Control horn (2)
Servo tape covers	Carbon spar tape covers

### Required Tools and Adhesives

Hex wrench: 1.5mm	6-minute epoxy
Hobby knife	

- 1. Use a hobby knife to enlarge the outer hole of a servo arm. Install the pushrod connector and secure it using the nylon nut supplied with your model.

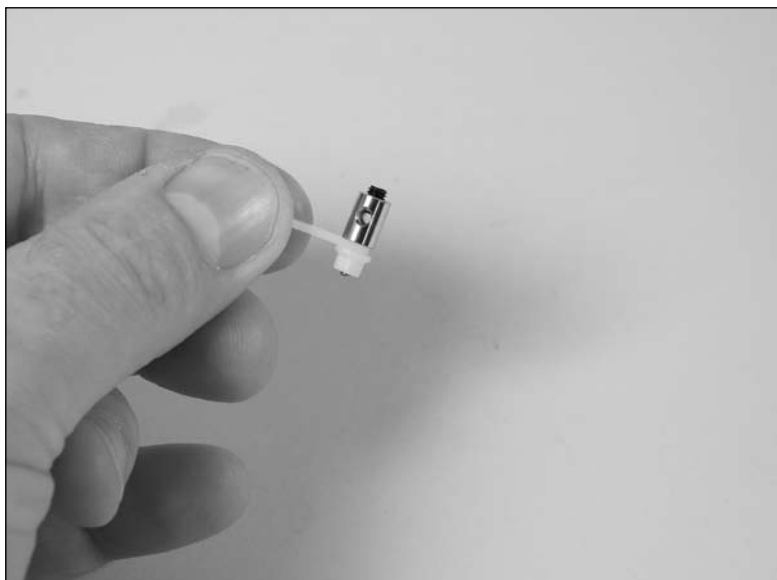

- 2. Install the servo arm on the aileron servos. Make sure to center the aileron servos using the radio system before installing the servo arms.

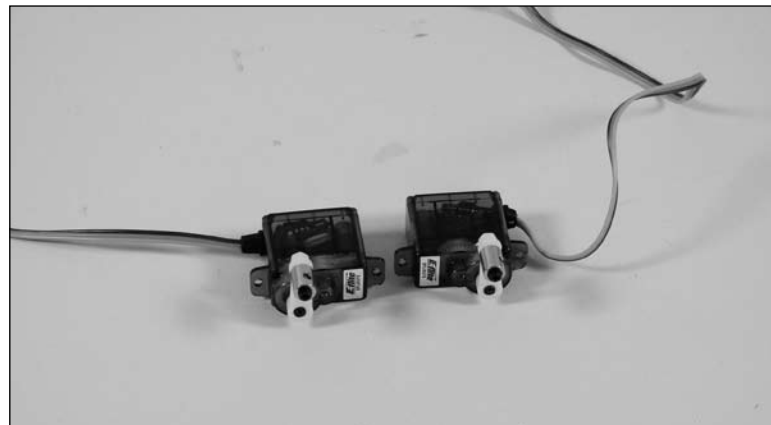

- 3. Use 6-minute epoxy to glue the aileron servo into the wing. Note that the servo arm faces toward the aileron. Press the servo lead into the channel in the wing as shown.

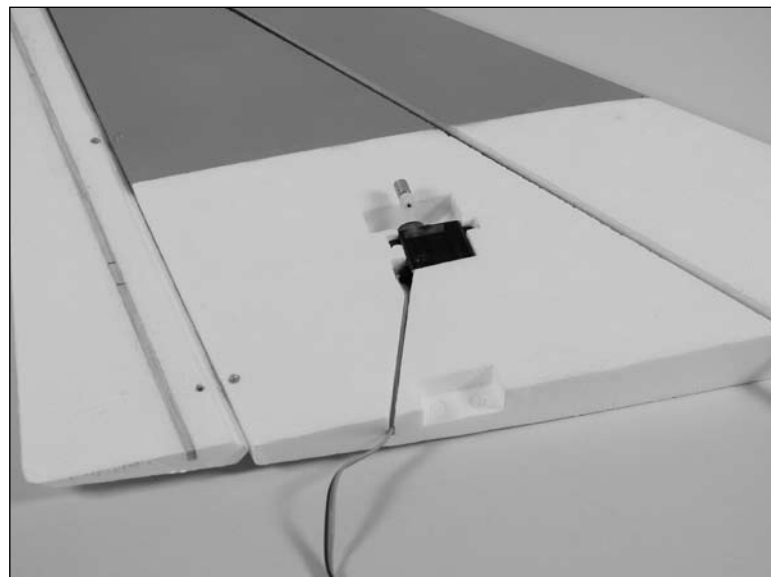

- 4. Slide a 75mm pushrod wire into the hole in the connector. Use a hobby knife to cut a 2mm wide slot in the aileron near the hinge line using the wire as a guide. Keep the wire perpendicular to the servo while cutting the slot.

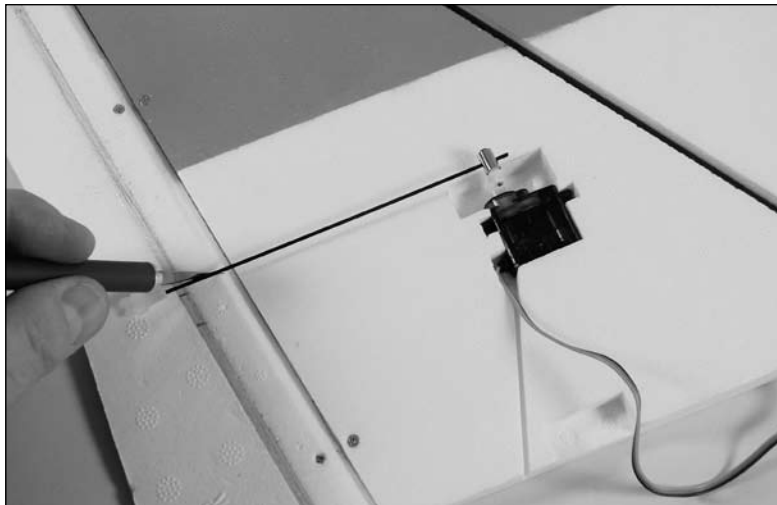

- 5. Use 6-minute epoxy to glue the control horn in the aileron as shown.

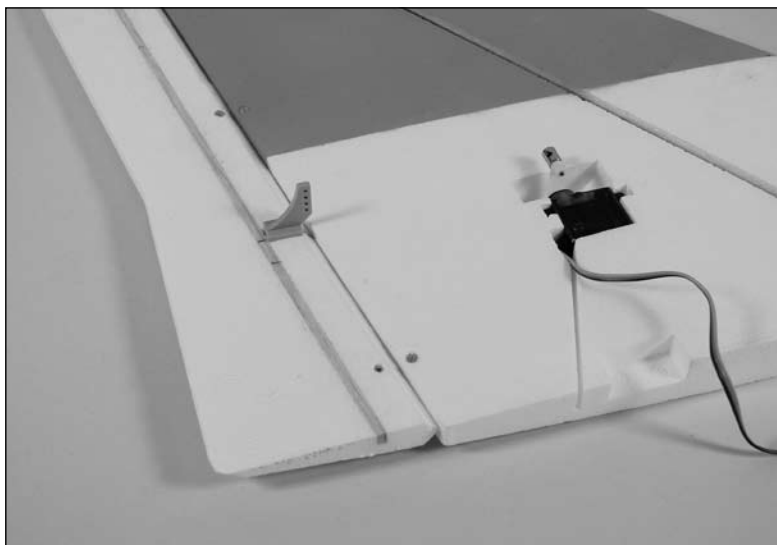

- 6. Connect the clevis to the control horn. With the aileron and aileron servo centered, tighten the setscrew in to connector with a 1.5mm hex wrench to secure the pushrod wire.

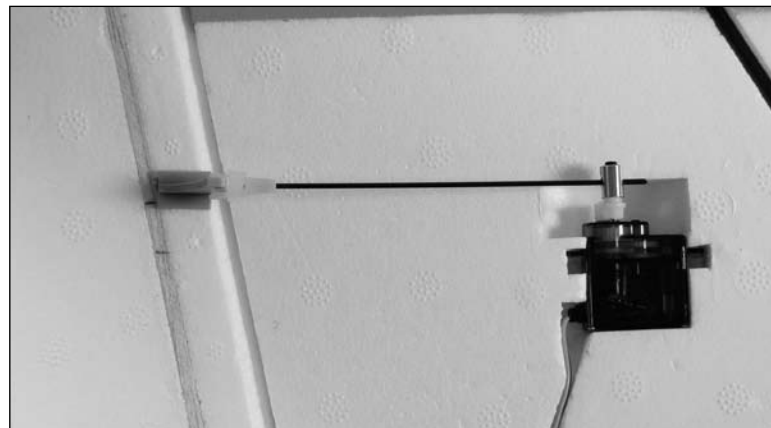

- 7. Use the supplied tape to cover the aileron servo and wire as shown. You may now cover the carbon spar with the white and orange tape.



- 8. Repeat Steps 1 through 7 to install the remaining aileron servo and linkage.

# Wing Panel Installation

## Required Parts

Assembled wing panel (right and left)

Assembled fuselage

## Required Tools and Adhesives

6-minute epoxy

Painter's tape

- ○ 1. Test fit the wing panel to the fuselage. You will need to cut a hole to route the aileron servo lead into the fuselage as shown.

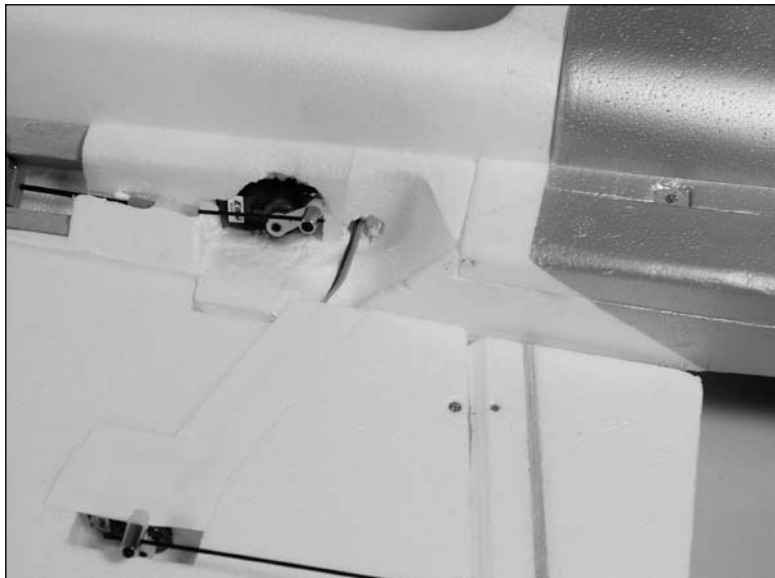

- ○ 2. Position the wing so it is parallel to your work surface when viewed from the front of the aircraft. Make sure the fuselage is parallel to the work surface as well. Use 6-minute epoxy to glue one wing panel to the fuselage. Use painter's tape to keep the wing tight against the fuselage while the epoxy cures.



- 3. Repeat Steps 1 and 2 to attach the remaining wing panel to the fuselage. Make sure the alignment of the second wing panel matches that of the first panel so the aircraft has an equal amount of dihedral for both right and left panels. If the dihedral does not match, it may require a lot of trim to correct and will not provide the best flight performance.

## Receiver Installation

### Required Parts

Assembled airframe

18-inch (457mm) lightweight servo extension (2) (aileron)

12-inch (305mm) lightweight servo extension (2) (main retract)

Y-harness (2) (3 if retracts are installed)

### Required Tools and Adhesives

Clear tape

Hook and loop tape

String

- 1. Secure an 18-inch (457mm) lightweight servo extension to each of the aileron servos. If retracts have been installed, secure 12-inch (305mm) extensions to each of the retract servos. Use clear tape to tape the leads and extensions inside the intake. You may use string to pull the extensions through the center of the model.



- 2. Secure the receiver on the top side of the same plywood plate the nose gear is attached to, using hook and loop tape. Plug the servo leads for the elevators, ailerons, retracts, nose gear steering and speed controls into the receiver. Use a Y-harness between each of the speed controls, between the aileron servo extensions and one of the main and nose gear retracts.

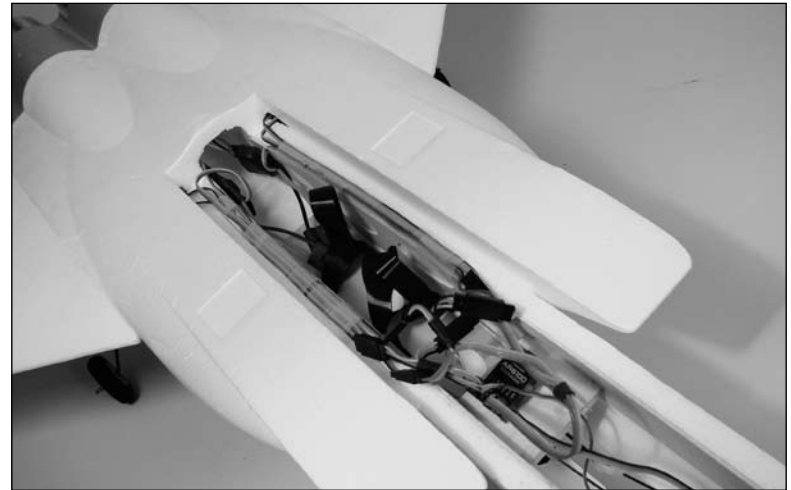

- 3. Use clear tape to secure the servo leads neatly inside the battery compartment. Doing so will make the installation and removal of the batteries much easier.



## Vertical Fin Installation

### Required Parts

Assembled airframe                      Vertical fin (right and left)

### Required Tools and Adhesives

6-minute epoxy

- 1. Position the right and left fins in the slots on the top of the fuselage.



- 2. Check the alignment between the right and left fins. They should be parallel to each other, and perpendicular to the top of the fuselage. If the alignment is correct, use 6-minute epoxy to glue the fins to the fuselage.

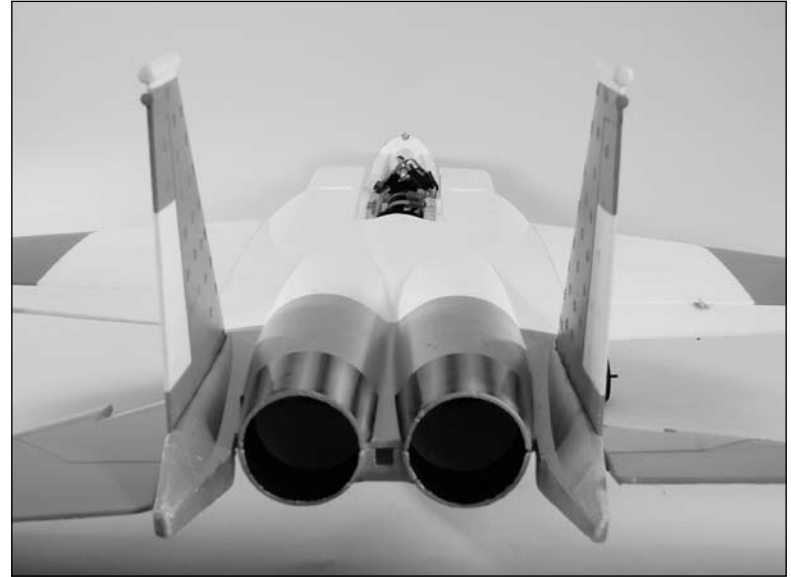

# Canopy Installation

## Required Parts

Assembled airframe                      Canopy hatch  
Canopy

## Required Tools and Adhesives

Painter's tape                              Canopy glue

- 1. Slide the tab at the back of the canopy hatch underneath the lip of the fuselage as shown.



- 2. Slide the canopy catch forward and press the canopy hatch down. Release the catch into position to secure the canopy.

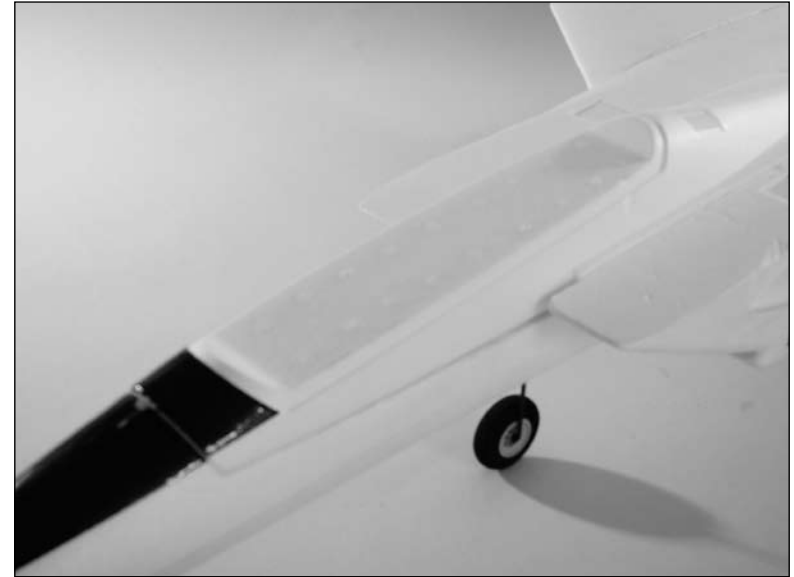

- 3. Use canopy glue to glue the canopy to the canopy hatch. Use painter's tape to keep the canopy in position until the glue fully cures.



## Control Throws

- 1. Turn on the transmitter and receiver of your F-15 Eagle. Check the movement of the rudder using the transmitter. When the stick is moved right, the rudder should also move right. Reverse the direction of the servo at the transmitter if necessary.
- 2. Check the movement of the elevator with the radio system. Moving the elevator stick down will make the airplane elevator move up.
- 3. Check the movement of the ailerons with the radio system. Moving the aileron stick right will make the right aileron move up and the left aileron move down.
- 4. Use a ruler to adjust the throw of the elevator, ailerons and rudder. Adjust the position of the pushrod at the control horn to achieve the following measurements when moving the sticks to their endpoints.

**Note:** Measurements are taken at the widest point on the surface.

### **Ailerons**

Low Rate: 1/2-inch (12mm) (Up/Down)

High Rate: 1-inch (25mm) (Up/Down)

### **Elevator**

Low Rate: 3/4-inch (19mm) (Up/Down)

High Rate: 1-inch (25mm) (Up/Down)

### **Nose Wheel Steering**

Low Rate: 10 degrees (left/right)

High Rate: 25 degrees (left/right)

These are general guidelines measured from our own flight tests. You can experiment with higher rates to match your preferred style of flying.

Once all the control throws have been set, make sure to slide the clevis retainers over the clevises to prevent them from opening accidentally.

**Note:** The following image shows the movement of the stabilator to the "up" position.

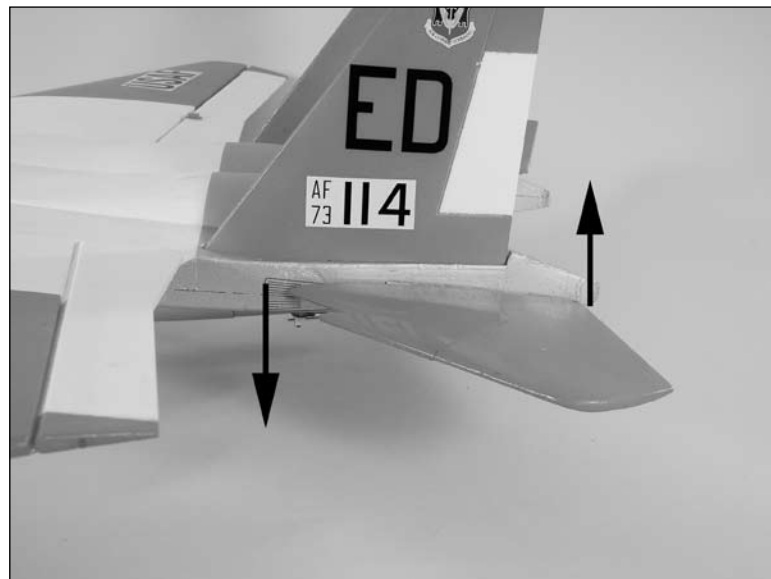



## Center of Gravity

An important part of preparing the aircraft for flight is properly balancing the model.

**Caution: Do not inadvertently skip this step!**

The recommended Center of Gravity (CG) location for the F-15 Eagle ARF is  $3\frac{3}{8}$ -inch (85mm) back from the leading edge of the wing. Mark the location of the CG on the top of the wing. You will notice two small dot stickers have been applied for your reference.

Please balance your model while it is upright with the batteries installed. If using retracts, balance with the gear retracted. If using (2) Thunder Power 2100 Pro-Lite Li-Po batteries, the balance should come out very close to the mark. With the model inverted, lift the model at the mark using your fingertips, or use a commercially available balancing stand. The model will rest level or slightly nose down when balanced correctly. Adjust the position of the motor battery, or add weight to the nose or tail if necessary to achieve the correct CG. Please understand that if you use a different Li-Po battery than the one included, you will need to rebalance the model to verify the Center of Gravity.

After the first flights, the CG position can be adjusted for your personal preference.

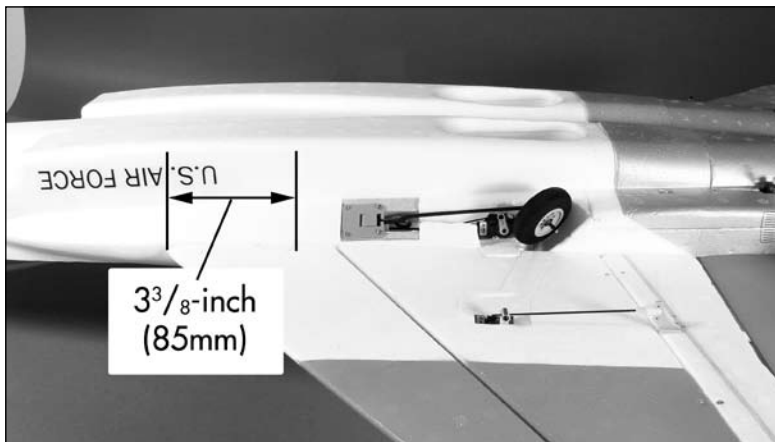

## Range Test Your Radio

- 1. Please consult your radio instructions for complete range testing instructions.
- 2. Double-check that all controls (aileron, elevator, rudder and throttle) move in the correct direction.
- 3. Be sure that your transmitter batteries are fully charged, per the instructions included with your radio.

## Instructions for Disposal of WEEE by Users in the European Union

This product must not be disposed of with other waste. Instead, it is the user's responsibility to dispose of their waste equipment by handing it over to a designated collection point for the recycling of waste electrical and electronic equipment. The separate collection and recycling of your waste equipment at the time of disposal will help to conserve natural resources and ensure that it is recycled in a manner that protects human health and the environment. For more information about where you can drop off your waste equipment for recycling, please contact your local city office, your household waste disposal service or where you purchased the product.



## Preflight

---

### **Check Your Radio**

Before going to the field, be sure that your batteries are fully charged per the instructions included with your radio. Charge both the transmitter and receiver pack for your airplane. Use the recommended charger supplied with your particular radio system, following the instructions provided with the radio. In most cases, the radio should be charged the night before going out flying.

Before each flying session, be sure to range check your radio. See your radio manual for the recommended range and instructions for your radio system. Each radio manufacturer specifies different procedures for their radio systems. Next, start the motor. With the model securely anchored, check the range again. The range test should not be significantly affected. If it is, don't attempt to fly! Have your radio equipment checked out by the manufacturer.

**Note:** Keep loose items that can get entangled in the propeller away from the prop. These include loose clothing, or other objects such as pencils and screwdrivers. Especially keep your hands away from the propeller.

Double-check that all controls (aileron, elevator, rudder and throttle) move in the correct direction.

Check the radio installation and make sure all the control surfaces are moving correctly (i.e. the correct direction and with the recommended throws). Test run the motor and make sure it transitions smoothly from off to full throttle and back. Also ensure the engine is installed according to the manufacturer's instructions, and it will operate consistently.

Check all the control horns, servo horns, and clevises to make sure they are secure and in good condition. Replace any items that would be considered questionable. Failure of any of these components in flight would mean the loss of your aircraft.

## Flying the F-15 Eagle

---

Flying the F-15 Eagle is about as easy as it can be with a small ducted fan. The large wing and full flying stabs make for a very maneuverable platform that is capable of some very slow high alpha flight.

If you elected to leave the gear off the model to maintain the lightest possible weight, you will need to hand launch the model. Using the two cheater holes in the bottom of the fuselage, this becomes a nice hand hold where you can grab hold of the model for a hand launch. To hand launch the model, all you need to do is apply full power and throw the model into the wind at a slightly nose up attitude. The plane will fly out without hesitation.

To take off from the ground, apply a small amount of elevator and full power. Steer the model straight with the nose gear. The plane should rotate within about 150 feet. Once you have rotated, ease off the elevator and continue to climb out at a nice angle of attack.

The model tracks very well through all basic aerobatic maneuvers. Inverted flight, rolls and loops are all accomplished with ease. To set up for landing, all that's needed is to lower the landing gear (if retracts are installed) and power back. As you lift the nose of the model, you will find the model behaves very well and it is easy to establish a shallow nose-high descent rate which can be managed with power. Touchdowns are nose high and the roll outs are straight down the runway. We hope you enjoy flying the F-15 Eagle as much as we do.

# 2008 Official AMA National Model Aircraft Safety Code

---

## GENERAL

- 1) I will not fly my model aircraft in sanctioned events, air shows or model flying demonstrations until it has been proven to be airworthy by having been previously, successfully flight tested.
- 2) I will not fly my model higher than approximately 400 feet within 3 miles of an airport without notifying the airport operator. I will give right-of-way and avoid flying in the proximity of full-scale aircraft. Where necessary, an observer shall be utilized to supervise flying to avoid having models fly in the proximity of full-scale aircraft.
- 3) Where established, I will abide by the safety rules for the flying site I use, and I will not willfully or deliberately fly my models in a careless, reckless and/or dangerous manner.
- 4) The maximum takeoff weight of a model is 55 pounds, except models flown under Experimental Aircraft rules.
- 5) I will not fly my model unless it is identified with my name and address or AMA number on or in the model. (This does not apply to models while being flown indoors.)
- 6) I will not operate models with metal-bladed propellers or with gaseous boosts, in which gases other than air enter their internal combustion engine(s); nor will I operate models with extremely hazardous fuels such as those containing tetranitromethane or hydrazine.

## RADIO CONTROL

- 1) I will have completed a successful radio equipment ground range check before the first flight of a new or repaired model.
- 2) I will not fly my model aircraft in the presence of spectators until I become a qualified flier, unless assisted by an experienced helper.
- 3) At all flying sites a straight or curved line(s) must be established in front of which all flying takes place with the other side for spectators. Only personnel involved with flying the aircraft are allowed at or in front of the flight line. Intentional flying behind the flight line is prohibited.

- 4) I will operate my model using only radio control frequencies currently allowed by the Federal Communications Commission. (Only properly licensed Amateurs are authorized to operate equipment on Amateur Band frequencies.)
- 5) Flying sites separated by three miles or more are considered safe from site-to-site interference, even when both sites use the same frequencies. Any circumstances under three miles separation require a frequency management arrangement, which may be either an allocation of specific frequencies for each site or testing to determine that freedom from interference exists. Allocation plans or interference test reports shall be signed by the parties involved and provided to AMA Headquarters.

Documents of agreement and reports may exist between (1) two or more AMA Chartered Clubs, (2) AMA clubs and individual AMA members not associated with AMA Clubs, or (3) two or more individual AMA members.

- 6) For Combat, distance between combat engagement line and spectator line will be 500 feet per cubic inch of engine displacement. (Example: .40 engine = 200 feet.); electric motors will be based on equivalent combustion engine size. Additional safety requirements will be per the RC Combat section of the current Competition Regulations.
- 7) At air shows or model flying demonstrations, a single straight line must be established, one side of which is for flying, with the other side for spectators.
- 8) With the exception of events flown under AMA Competition rules, after launch, except for pilots or helpers being used, no powered model may be flown closer than 25 feet to any person.
- 9) Under no circumstances may a pilot or other person touch a powered model in flight.



© 2008 Horizon Hobby, Inc.  
4105 Fieldstone Road  
Champaign, Illinois 61822  
(877) 504-0233  
[horizonhobby.com](http://horizonhobby.com)  
[E-fliteRC.com](http://E-fliteRC.com)