

# BAe Hawk 15 DF

## Assembly Manual



### Specifications

Wingspan:	33 in (846mm)
Length:	35.4 in (381mm)
Wing Area:	206 sq in (13.2 sq dm)
Weight w/o Battery:	34-36 oz (964-1021 g)
Weight w/Battery:	43-46 oz (1219-1304 g)

Pilots not included (PKZ4414)

## Table of Contents

Introduction .....	2
Important Information Regarding Warranty Information .....	2
Using the Manual.....	2
Contents of Kit/Parts Layout.....	2
Recommended Radio Equipment .....	3
Required Tools and Adhesives .....	3
Optional Accessories.....	3
Required Brushless Ducted Fan Setup.....	3
Note on Lithium Polymer Batteries .....	3
Warning.....	3
Fan Installation.....	4
Aileron Servo Installation.....	6
Aileron Linkage Installation.....	8
Mounting the Main Wing Panels .....	11
Stabilizer Installation .....	13
Elevator Installation .....	17
Elevator Linkage Installation .....	19
Landing Gear Installation.....	21
Nose Gear and Elevator Servo Installation.....	23
Speed Control and Receiver Installation .....	25
Canopy Installation .....	26
Thrust Tube Installation.....	28
Motor Battery Installation .....	29
Accessory Installation .....	29
Control Throws.....	30
Center of Gravity .....	31
Preflight.....	31
Range Test Your Radio .....	32
Flying Your BAe Hawk.....	32
Safety, Precautions and Warnings .....	32
Warranty Information.....	32
Instructions for Disposal of WEEE by Users in the European Union.....	34
2008 Official Academy of Model Aeronautics Safety Code .....	35

## Introduction

Designed as a trainer and light combat aircraft for use by the British Royal Air Force, the British Aerospace (BAe) Hawk was mainly used to teach air combat, air-to-air firing, air-to-ground firing, low-altitude flying techniques and operation procedures. There are currently over 900 Hawks in operation and nearly 2 million flying hours have been logged on the Hawk.

E-flite's BAe Hawk 15 DF ARF is a sport scale version of the British trainer. Constructed of fiberglass and balsa, the fuselage is prefinished with scale details. The Hawk boasts the rare and very visible Central Flying School airshow trim scheme from 1987 in red, white and blue.

This performance model was designed around E-flite's Delta V 15 (69mm) fan unit and matched 15 DF brushless motor. Pilots can use a 3-cell battery pack or utilize a 4-cell battery pack for increased vertical performance. The built-in fan mounts make installing the fan easy—just drop in the fan unit and tighten four screws. The removable front hatch also allows easy access to the radio equipment and battery. The entire trim scheme is pre-painted, pre-trimmed, the wings are covered in UltraCote® and all the decals have already been applied.

## Important Information Regarding Warranty Information

Please read our Warranty and Liability Limitations section on Page 32 before building this product. If you as the Purchaser or user are not prepared to accept the liability associated with the use of this Product, you are advised to return this Product immediately in new and unused condition to the place of purchase.

## Using the Manual

This manual is divided into sections to help make assembly easier to understand, and to provide breaks between each major section. In addition, check boxes have been placed next to each step to keep track of its completion. Steps with a single circle (○) are performed once, while steps with two circles (○○) indicate that the step will require repeating, such as for a right or left wing panel, two servos, etc.

Remember to take your time and follow the directions.

## Contents of Kit/Parts Layout

### Replacement Parts

EFL8026	Fuselage with side hatch
EFL8027	Canopy Hatch
EFL8028	Wing Panel with Hinged Aileron Left
EFL8029	Wing Panel with Hinged Aileron Right
EFL8030	Horizontal Stabilizer with Elevator L & R
EFL8031	Pushrods and Carbon Wing Tubes
EFL8032	Plastic Accessories
EFL8033	Landing Gear and Wheels with Hardware
EFL8034	Control Hardware



## Recommended Radio Equipment

You will need a minimum 4-channel transmitter, receiver and four or five servos (if using nose gear steering). You can choose to purchase a complete radio system. If you are using an existing transmitter, just purchase the other required equipment separately. We recommend the crystal-free, interference-free Spektrum™ DX6i 2.4GHz DSM® 6-channel system. If using your own transmitter, we recommend the E-flite® S75 Super Sub-Micro servos .

If you own the Spektrum DX6i radio, just add the AR6200 DSM2™ 6-channel receiver and four or five (nose gear steering) E-flite S75 Sub-Micro servos.

### Complete Radio System

SPM6600 DX6i DSM2 6CH system

### Or Purchase Separately

SPMAR6200 AR6200 DSM2 6-Channel Full-Range Receiver (for DX6i or DX7)

### And

EFLRS75 7.5-gram Sub-Micro S75 Servo  
EFLREX3L 3-inch Extension, Lightweight (2)  
EFLREX9L 9-inch Extension, Lightweight (2)

## Required Brushless Ducted Fan Setup

EFLM3015DF 15 DF Brushless Motor, 3600Kv  
EFLDF15 Delta V 15 (69mm) Ducted Fan Unit  
EFLA1060 60-Amp Pro Switch-Mode BEC Brushless ESC  
EFLB32003S 3200mAh 3S 11.1V 20C Li-Po, 13GA EC3

The Spektrum trademark is used with permission of Bachmann Industries, Inc.

## Required Tools and Adhesives

### Tools & Equipment

Drill	Epoxy brushes
Felt-tip pen	Hex wrench: 1.5mm
Hobby scissors	Low-tack tape
Mixing cups	Mixing sticks
Needle-nose pliers	Medium grit sandpaper
Paper towels	Pencil
Pin drill	Rubbing alcohol
Ruler	Scissors
Side cutters	Square
String/dental floss	Toothpicks
T-pins	Waxed paper
Phillips screwdriver: #0, #1	
Hobby knife (#11 blade)	
Drill bit: 1/16-inch (1.5mm), 5/64-inch (2mm)	

### Adhesives

Threadlock	6-Minute Epoxy (HAN8000)
Canopy glue	12-Minute Epoxy (HAN8001)
Thin CA	Medium CA

## Optional Accessories

PKZ4414	Pilot: T-28
EFLA110	Power Meter
EFLC3005	Celectra™ 1- to 3-Cell Li-Po Charger
EFLC505	Intelligent 1- to 5-Cell Balancing Charger

## Note on Lithium Polymer Batteries



Lithium Polymer batteries are significantly more volatile than alkaline or Ni-Cd/ Ni-MH batteries used in RC applications. All manufacturer's instructions and warnings must be followed closely. Mishandling of Li-Po batteries can result in fire. Always follow the manufacturer's instructions when disposing of Lithium Polymer batteries.

### Warning

An RC aircraft is not a toy! If misused, it can cause serious bodily harm and damage to property. Fly only in open areas, preferably at AMA (Academy of Model Aeronautics) approved flying sites, following all instructions included with your radio.

Keep loose items that can get entangled in the propeller away from the prop, including loose clothing, or other objects such as pencils and screwdrivers. Especially keep your hands away from the propeller.

During the course of building your BAe Hawk we suggest that you use a soft base for the building surface. Such things as a foam stand, large piece of bedding foam or a thick bath towel will work well and help protect the model from damage during assembly.

## Fan Installation

### Required Parts

Fuselage                      Fan assembly  
Thrust tube  
2mm x 8mm sheet metal screw (4)

### Required Tools and Adhesives

Felt-tip pen                      Hobby scissors  
Drill                                  Drill bit: 1/16-inch (1.5mm)  
Thin CA                              Phillips screwdriver: #1

- 1. Remove the cover from the fuselage to allow access for the fan assembly installation. Set the cover aside in a safe place.



- 2. Slide the thrust tube onto the fan assembly and over the motor wires.



- 3. Position the thrust tube on the fan assembly so it is rotated as shown. This will leave the gap necessary to fit the tube onto the fan assembly, allowing for clearance between the thrust tube and the fan mount to the fuselage.

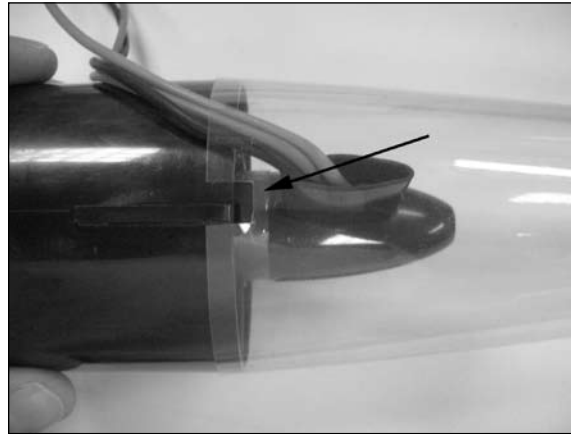

- 4. Use a felt-tip pen to mark the position of the motor wires onto the thrust tube.

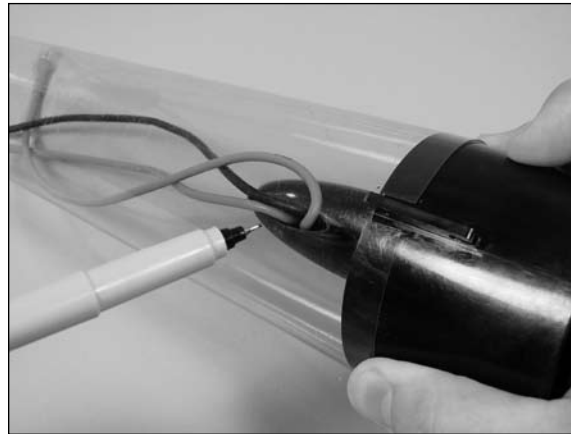

- 5. Use hobby scissors to trim the thrust tube for the motor wires. Set the thrust tube aside at this time as it will not be installed until later in the manual.

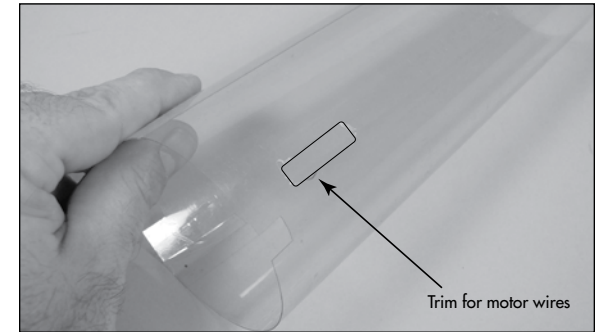

- 6. Move the elevator pushrod tube upwards to allow for the installation of the fan assembly.



- 7. Guide the motor wires into the hole in the fuselage former. The wires will be on the side of the center line former that is away from the opening as shown.



- 8. Install the fan by inserting it tail-end first into the fuselage as shown. The technique is very similar to parallel parking by backing the assembly in then moving it forward inside the fuselage.

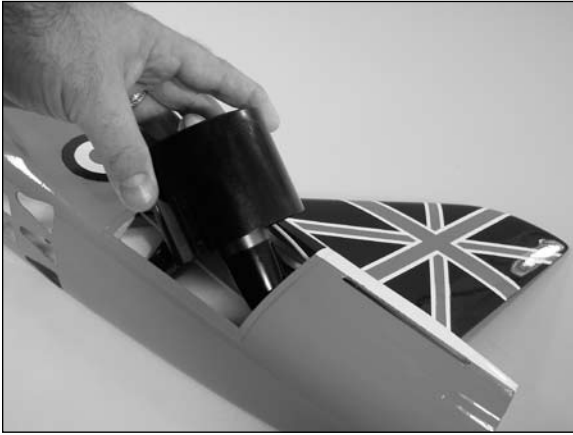

- 9. Slide the fan assembly as far forward in the fuselage as possible without damaging the fan assembly or fuselage. The front edge of the fan assembly will fit snugly into the fan intake inside the fuselage.

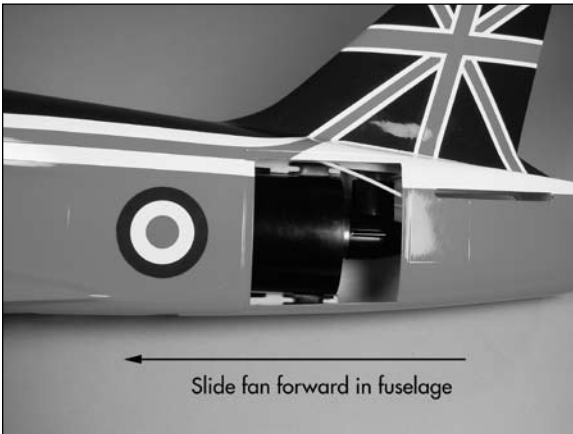

- 10. Use a drill and 1/16-inch (1.5mm) drill bit to drill four 1/16-inch (1.5mm) holes into the fan mount in the fuselage that correspond to the notches in the mounting flanges of the fan assembly. Position the holes as close to the center of the assembly to prevent the fan from shifting in the fuselage.

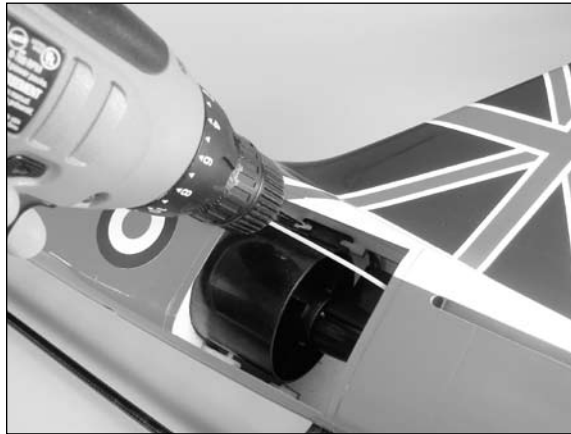

- 11. Apply 2–3 drops of thin CA into each of the four holes to harden the surrounding wood. This is done to provide a harder surface for the screws to bite into and will help in preventing them from vibrating loose.

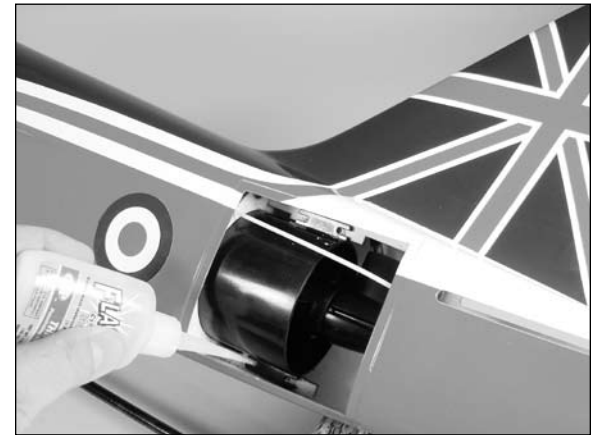



- 12. Use a #1 Phillips screwdriver and four 2mm x 8mm sheet metal screws to secure the fan assembly inside the fuselage.



## Aileron Servo Installation

### Required Parts

Left wing panel      Right wing panel  
 2.5 x 10mm sheet metal screw (4)  
 Aileron servo mount (2)  
 Servo mounting strap (2)

### Required Tools and Adhesives

Servo (2)              Medium grit sandpaper  
 6-minute epoxy      Phillips screwdriver: #1

- 1. Relocate the string from the aileron opening so it is near one of the corners. This will give full access to the opening and prevent accidentally gluing the string into the wing.

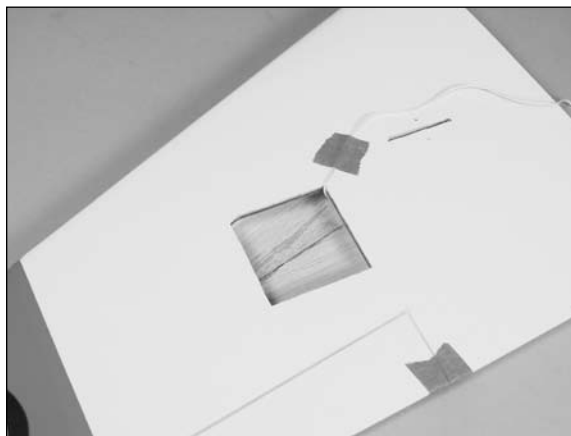

### ***E-tips***

DO NOT remove the string from the wing. The string will be used to pull the aileron servo lead through the wing later in this section.

- 2. Measure and mark the opening for the aileron servo 3/4-inch (19mm) from the edge that is closest to the wing tip as shown. The edge of the aileron servo mount will align with these marks when it is installed. Center the mount fore/aft in the opening for the aileron servo.

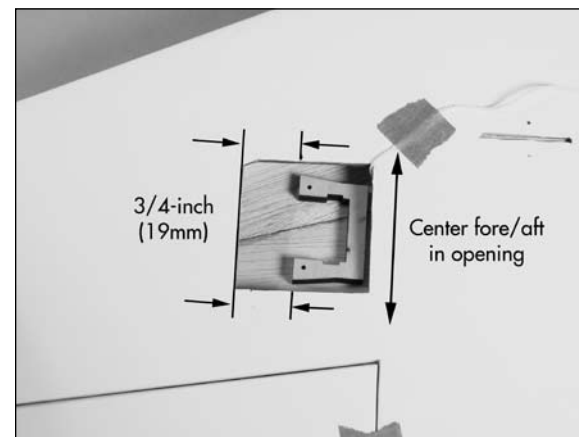

- 3. Lightly sand the aileron servo mount using medium grit sandpaper. This will allow the glue to penetrate into the mount and provide a better bond between the mount and wing.



- ○ 4. Mix a small amount of 6-minute epoxy and brush it onto the side of the aileron servo mount that was sanded in the previous step. Position the mount in the wing as shown in Step 2 and allow the epoxy to fully cure before proceeding.



### ***E-tips***

While waiting for the epoxy to dry on one wing panel, you can step through the previous steps to glue the remaining servo mount into the opposite wing panel.

- ○ 5. Plug the aileron servos into the receiver and use the transmitter to center the servos. Also check that they are operating correctly at this time. Remove the standard servo horn and install the single-sided servo arm that was supplied with the servo.

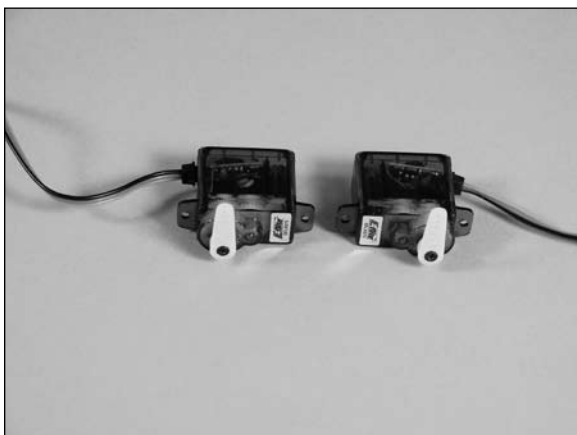

- ○ 6. Position the aileron servo in the servo mount as shown in the image.

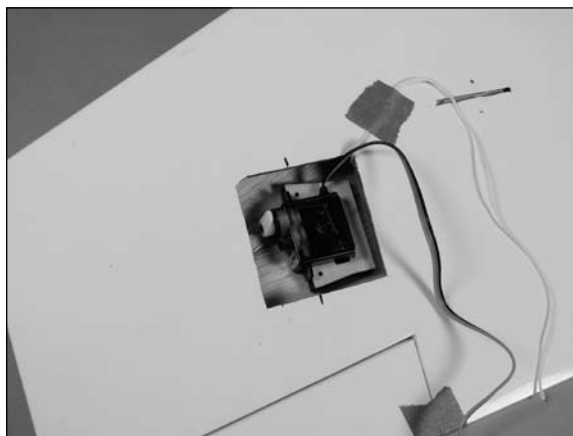

- ○ 7. Use a #1 Phillips screwdriver and two 2.5mm x 10 sheet metal screws to secure the servo in the servo using the servo mounting strap. Install one screw and only turn it one or two turns, then install the second screw. Make sure the strap has even pressure at both the front and back of the servo.

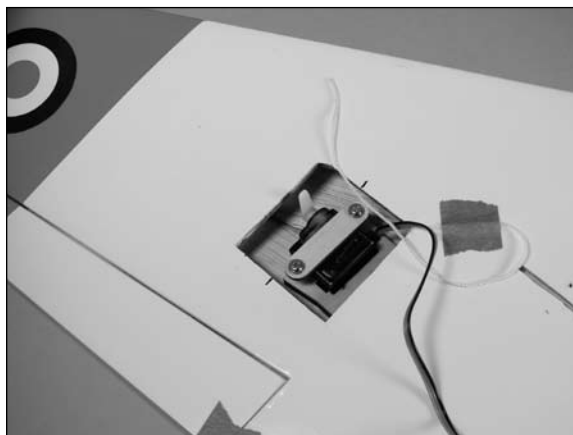

### ***E-tips***

Use care when installing the servo mounting strap. Over-tightening the strap could stress the wing sheeting and even push the servo through the top of the wing.

- ○ 8. Tie the string around the end of the servo lead as shown.

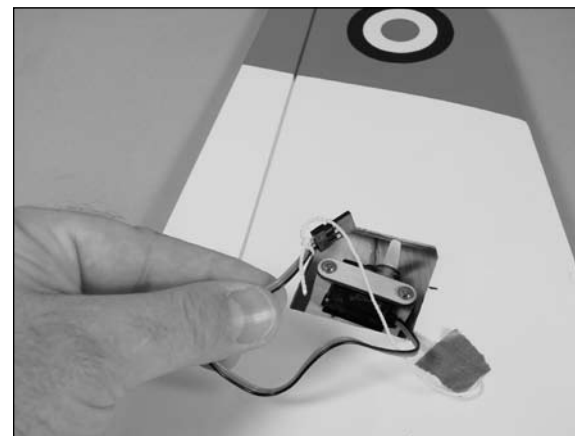

- ○ 9. Carefully pull the aileron servo lead through the wing using the string tied to it in the previous step.

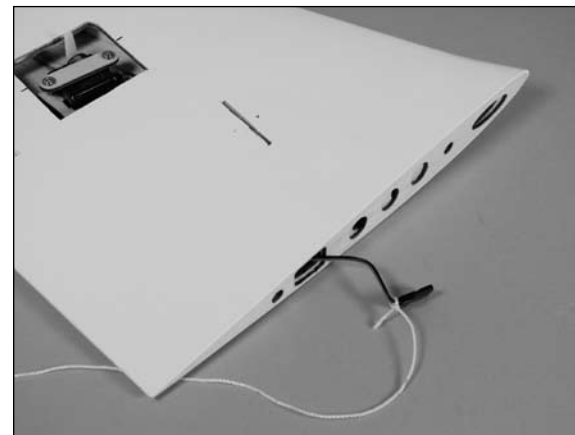

- 10. Repeat Steps 1 through 9 to install the remaining aileron servo.

## Aileron Linkage Installation

### Required Parts

Aileron pushrod keeper (2)  
Aileron pushrod wire, 5<sup>15</sup>/<sub>16</sub>-inch (151mm) (2)  
Servo cover (2)  
Aileron control horn (2)      Clear tape

### Required Tools and Adhesives

Side cutters              Medium CA  
Pin drill                  Drill bit: 5/64-inch (2mm)  
Felt-tip pen              Hobby knife w/#11 blade  
Needle-nose pliers      Hobby scissors  
Medium grit sandpaper

- 1. Using a felt tip pen mark the aileron for the aileron control horn. The horn is positioned 13/32-inch (10mm) back from the hinge line of the aileron. Also mark a center line that corresponds with the aileron servo horn.

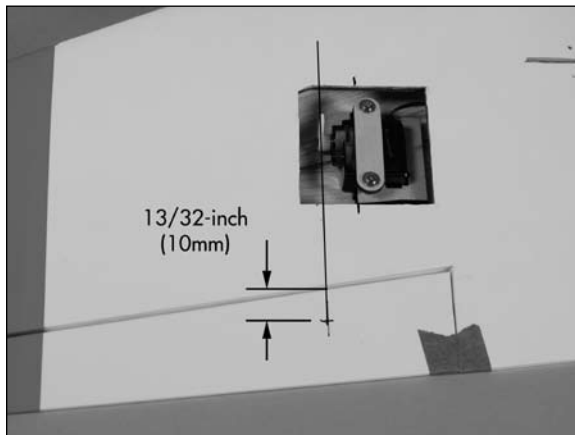

**E-tips**

Use low-tack tape to tape the aileron in position so it doesn't move during the linkage installation. This will make the procedure go easier and will help in keeping things aligned during the linkage installation process.

- 2. Position the control horn so it is aligned with the marks made in the previous step. Lightly press the control horn down to leave the indentations of the prongs in the aileron. The control horn should be aligned 90 degrees to the aileron hinge line in line with the servo arm.

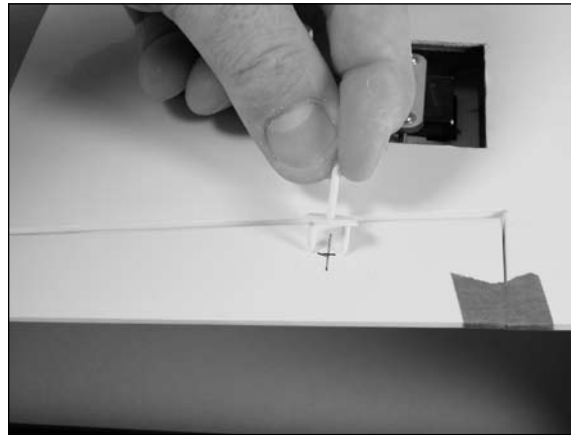

- 3. Use side cutters to remove 3/32-inch (2mm) from the prongs of the servo horn so they do not extend through the top of the aileron when the control horn is installed.

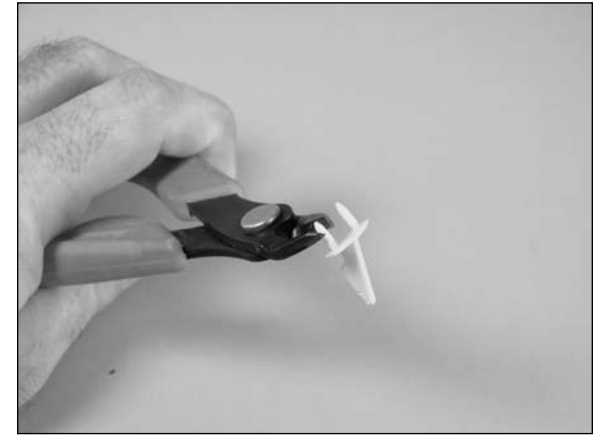

- 4. Use a pin drill and 5/64-inch (2mm) drill bit to drill the two holes for the control horn prongs. Use care not to drill into the aileron too far and accidentally drill through the top of the aileron.

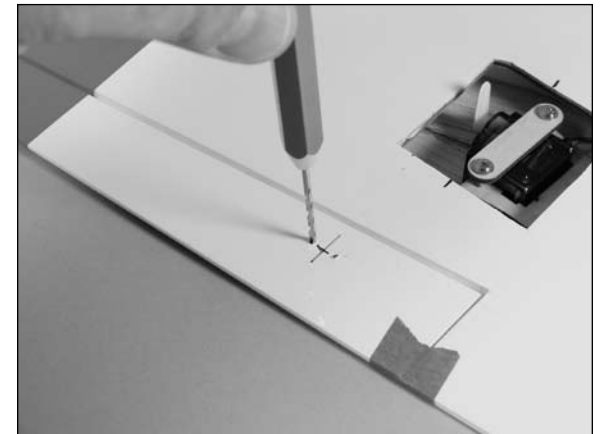



- 5. Position the control horn on the aileron and trace the outline of the horn onto the wing using a felt-tip pen.



- 6. Use a hobby knife and a new #11 blade to remove the covering 1/16-inch (1.5mm) from the inside of the lines drawn in the previous step. Use care not to cut into the underlying wood of the aileron.

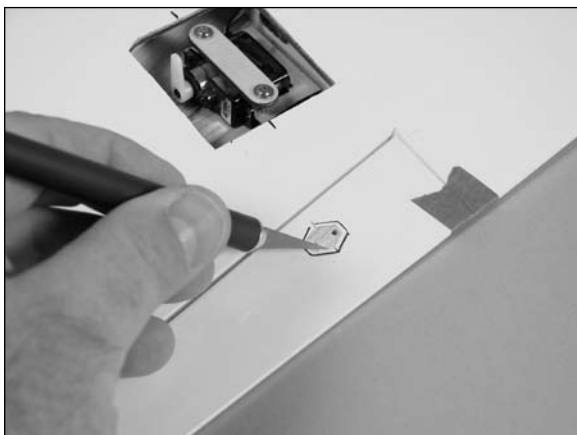

### ***E-tips***

Use a paper towel and rubbing alcohol to remove the lines from the aileron once the covering has been removed.

- 7. Use medium CA to glue the aileron control horn to the aileron. Allow the CA to fully cure before proceeding.

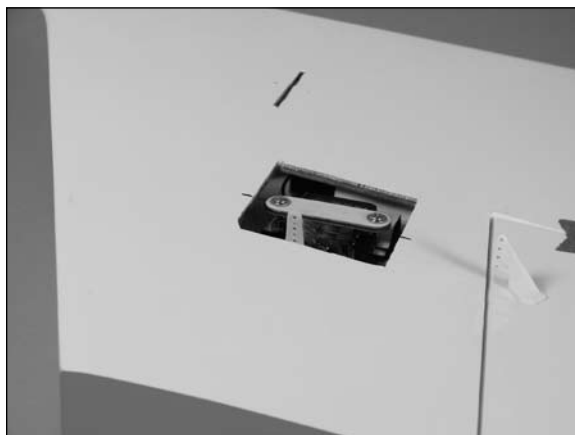

- 8. Insert the Z-bend of the aileron pushrod into the hole of the servo arm that is farthest from the center of the arm.

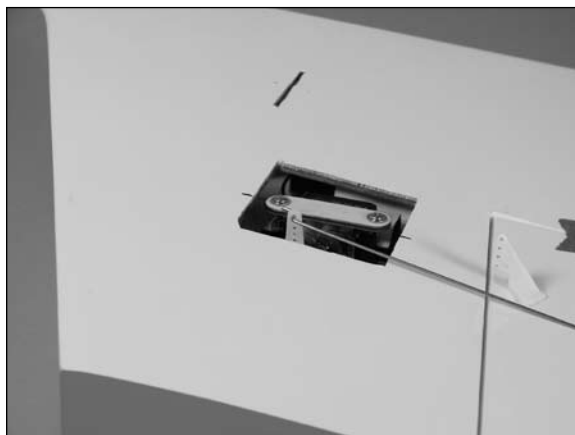

- 9. Slide the pushrod keeper onto the aileron pushrod wire as shown in the photo.



### ***E-tips***

There are two pairs of pushrod keepers included with your aircraft. The correct ones for the aileron pushrods will have larger holes than the elevator pushrod keepers. If the keepers are difficult to slide on the wire, try a different keeper, as they should slide easily on the pushrod wire. Make sure that these pushrod keepers are slid on to the pushrods before making the bend in Step 11.

- 10. Make sure the aileron servo has been centered using the radio system. Mark the pushrod using a felt-tip pen where it crosses the hole in the aileron control horn that is one up from the bottom of the horn as shown.

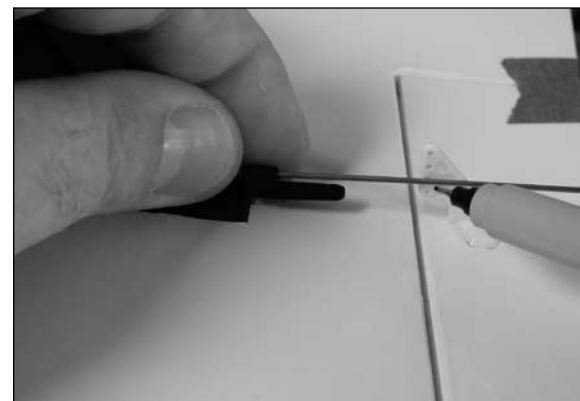

- ○ 11. Use needle-nose pliers to bend the pushrod wire 90 degrees at the mark made in the previous step. After making the 90-degree bend, cut the excess wire off of the pushrod leaving 1/4-inch (6mm) from the bend in the pushrod.

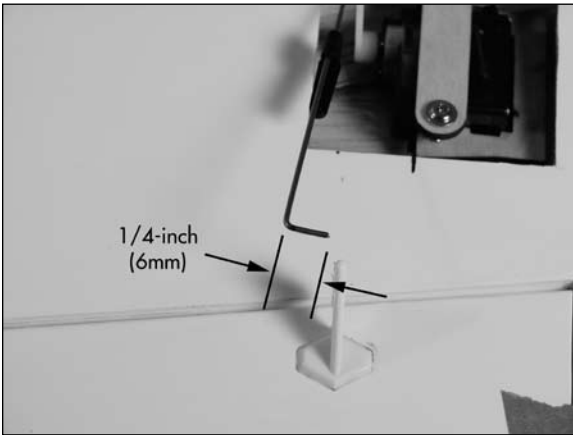
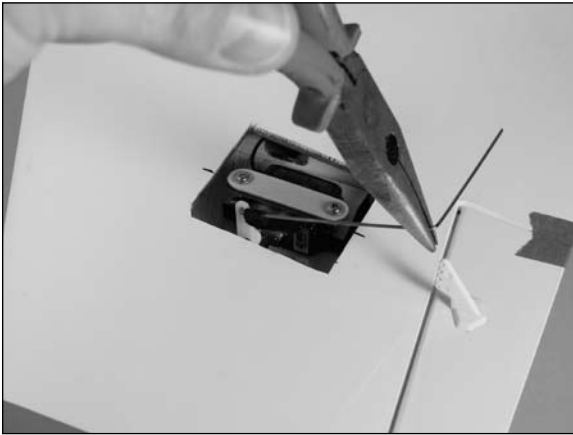

- ○ 12. Insert the bend into the hole in the aileron control horn that is one up from the bottom of the horn as shown.

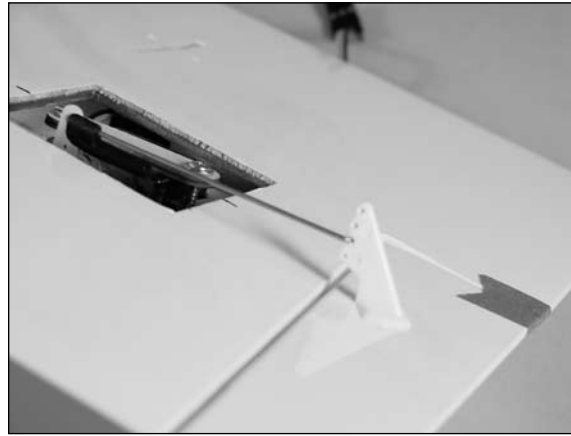

- ○ 13. Use needle-nose pliers to open the pushrod connector wire enough that it can be fit onto the pushrod wire.

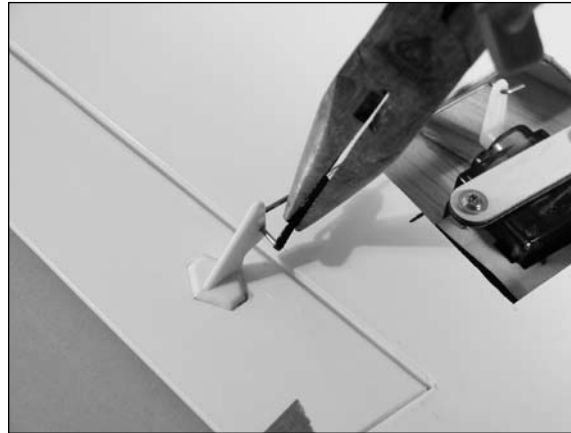

- ○ 14. Make sure the hole in the keeper fits onto the pushrod wire. The keeper should fit close to the control horn and not be bent when installed correctly.

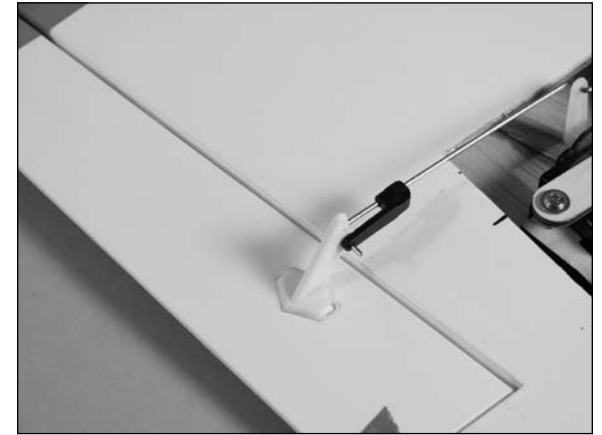

- ○ 15. Use hobby scissors to trim the aileron control horn servo cover on the lines that are molded into it. Use medium grit sandpaper to clean up and rough edges and to round the corners slightly on the cover.

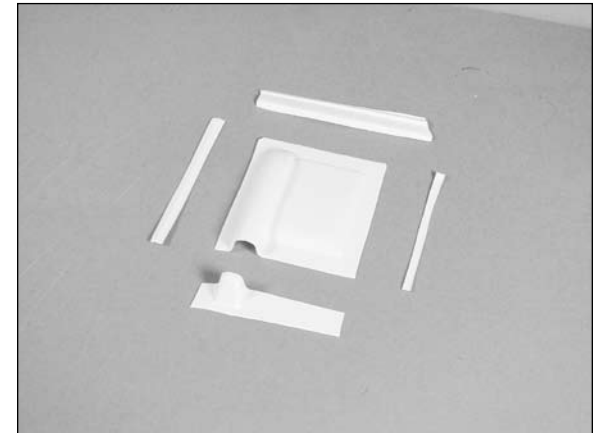

- 16. Cut four pieces of clear tape from the supplied tape using scissors and use them to attach the servo cover to the wing. Make sure the servo can operate without binding on the servo cover.

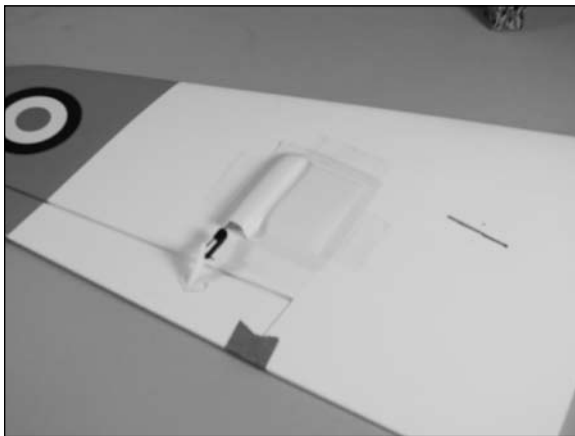

### ***E-tips***

You can also glue the cover to the wing using canopy glue or epoxy. The only drawback is that if you ever have a problem with the servo you may damage the cover and wing covering removing the servo cover.

- 17. Repeat Steps 1 through 16 to install the remaining aileron servo linkage.

## ***Mounting the Main Wing Panels***

### **Required Parts**

Left wing assembly    Right wing assembly  
Carbon wing rod, short  
Carbon wing rod, long  
Fuselage assembly  
9 inch (228mm) extension (2)

### **Required Tools and Adhesives**

15-minute epoxy    Mixing cup  
Mixing stick        Epoxy brush  
Paper towel        Rubbing alcohol  
Low-tack tape     Sandpaper  
Dental floss/string

- 1. Secure a 9-inch (228mm) servo extension to the aileron servo lead. Use thread or dental floss to secure the two together so they do not become unplugged inside the fuselage.



### ***E-tips***

You can also use large heat shrink to secure the extension to the servo lead. Be careful not to get the heat shrink too hot as it could distort the plug.

- 2. Slide the short and long wing rods into one of the wing panels. The longer wing rod will be inserted near the trailing edge of the wing, and the shorter rod toward the leading edge of the wing.

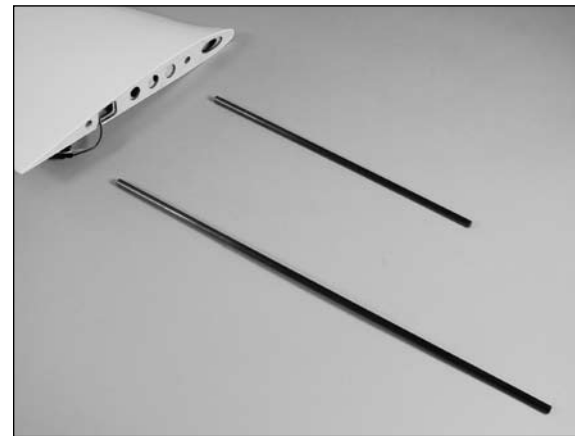

- 3. Slide the wing tubes into the fuselage. Make sure to guide the aileron servo extension into the fuselage so the wing can fit tight against the fuselage.



- ○ 4. Look at the fit of the wing to the fuselage on both the top and bottom. You will need to use sandpaper to remove the paint from the fuselage where the wing fits or the epoxy won't hold the wing securely to the fuselage. You also don't want to sand too much and ruin the wonderful paint job on the fuselage.

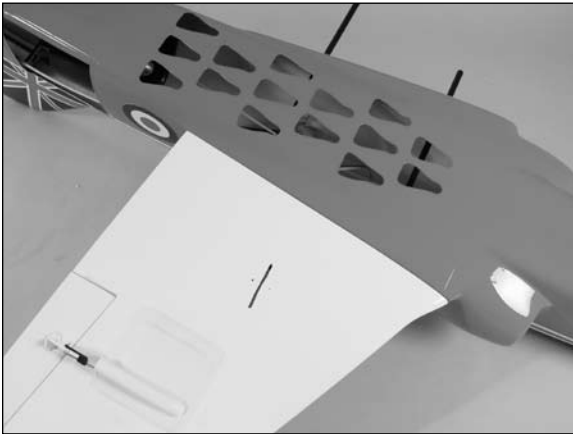

### ***E-tips***

You can use low-tack tape to make an outline about a 1/16-inch (1.5mm) inside the wing outline on the fuselage to prevent it from scratching the paint.

- ○ 5. Remove the wing from the fuselage. Use medium grit sandpaper to remove the paint from the fuselage where the wing fits.



- 6. Repeat Steps 1 through 5 to prepare the opposite side of the fuselage for the wing.



- ○ 7. Apply a thin layer of 15-minute epoxy to the fuselage where it was sanded previously.



- ○ 8. Apply a thin layer of 15-minute epoxy to the short and long wing rods before you insert them into the wing.

- ○ 9. Apply a thin coat of 15-minute epoxy on the end of the wing that will butt against the fuselage.



- 10. Slide the wing into position against the fuselage. Use low-tack tape to keep the wing tight against the fuselage until the epoxy fully cures.

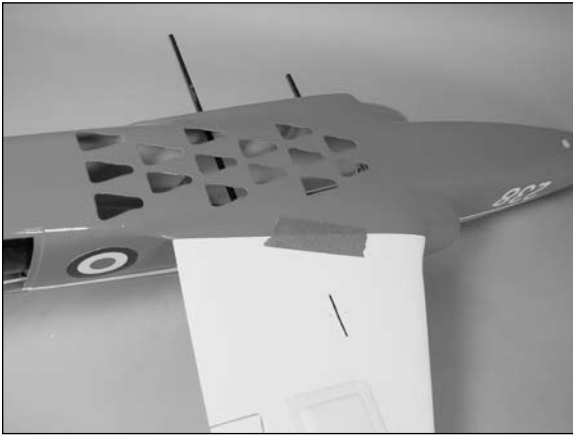

- 11. Repeat Steps 7 through 9 to install the remaining wing panel to the fuselage.

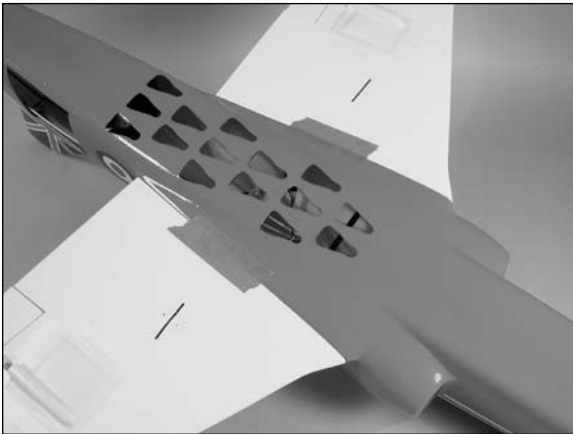

- 12. Before the epoxy cures, use a paper towel and rubbing alcohol to remove any excess epoxy that may have oozed out from between the joint between the wing and fuselage.



## Stabilizer Installation

### Required Parts

Stabilizer jig center    Stabilizer jig side (2)  
 Right stabilizer      Left stabilizer  
 Airframe assembly

### Required Tools and Adhesives

Medium CA              Square  
 6-minute epoxy        Mixing cup  
 Mixing stick            Epoxy brush  
 Paper towel             Rubbing alcohol  
 Low-tack tape         Waxed paper  
 Ruler                     Felt-tip pen  
 Hobby knife w/#11 blade

- 1. Use a square and medium CA to glue the stabilizer jig center to the stabilizer jig side. The square will keep the center perpendicular to the side and result in a straight jig. Not doing so may result in the jig being crooked and could produce the wrong angle when gluing the stabilizer halves together.

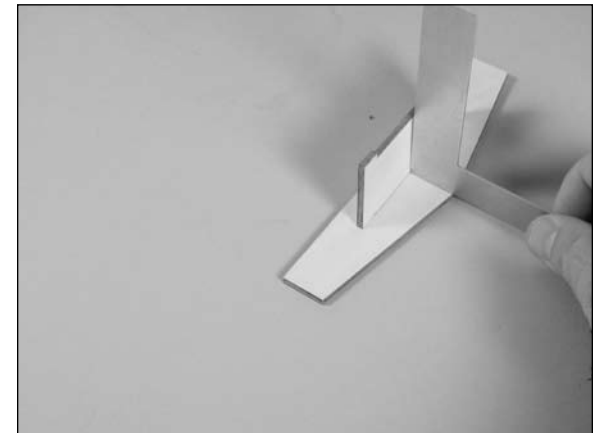



- 2. Use a square and medium CA to glue the stabilizer jig side to the structure assembled in Step 1. Use a square will keep the side perpendicular to the stabilizer jig center. Not doing so may result in the jig being crooked and could produce the wrong angle when gluing the stabilizer halves together.

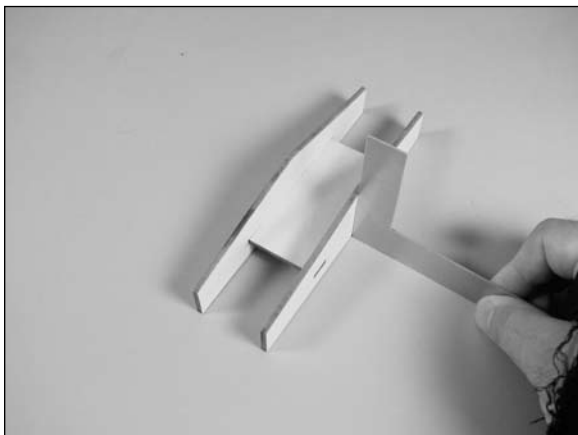

- 3. Remove the elevators from the stabilizer halves. Use a hobby knife w/#11 blade to remove the covering from the end of both the left and right stabilizers.

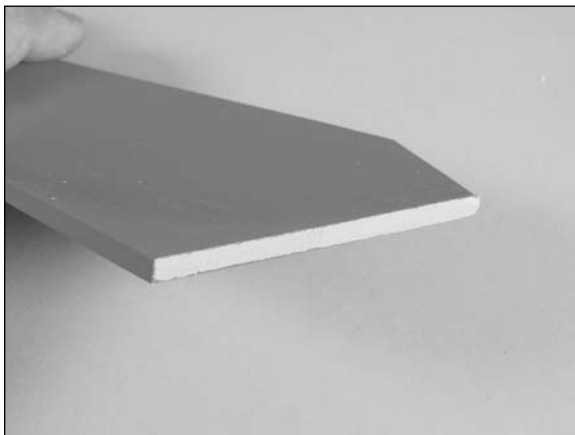

- 4. The stabilizer halves have been prepared at the factory with an angle so they fit tightly together when joined. If fit together incorrectly, the two halves will not fit tightly together.

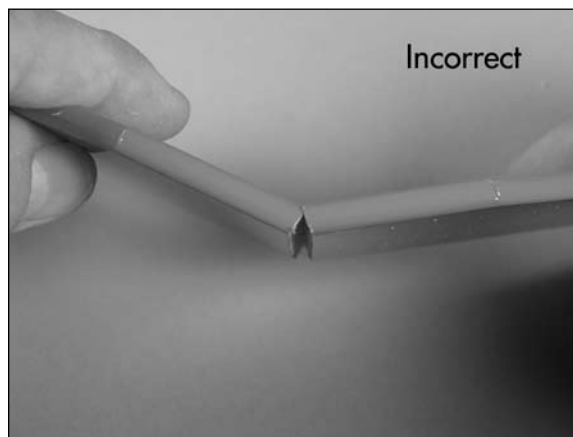
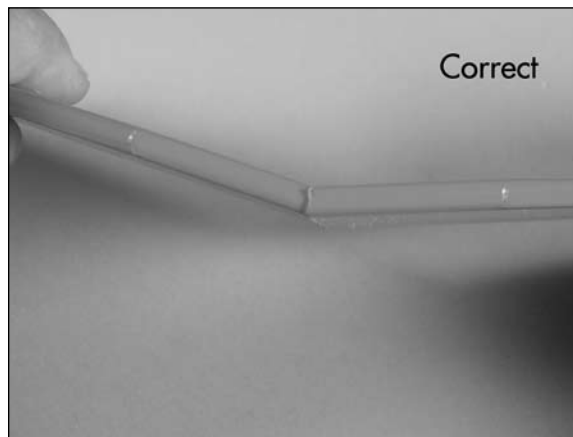

- 5. Place a piece of clear plastic or waxed paper over the stabilizer jig to prevent gluing the stabilizer directly to the jig.



- 6. Position the two stabilizer halves together (remember the angle) and align the front edges of the stabilizer halves. Use a small piece of low-tack tape to act as a hinge and keep the halves aligned.

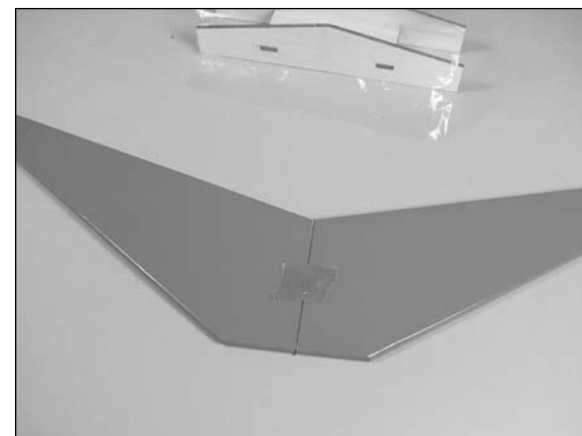

- 7. Position the stabilizer assembly on the jig to make sure the halves can rest against the jig without forcing them. If not, you will need to make a small gap between the two halves before taping them together.



- 8. Mix a small amount of 6-minute epoxy and use an epoxy brush to apply a thin layer of epoxy on the edges of each stabilizer half.



- 9. Position the stabilizer on the jig and either hold it or use weights to keep the halves tight against the jig until the epoxy fully cures.



- 10. Slide the stabilizer into the slot in the fuselage. Measure the distance from the fuselage to the tip of the stabilizer on both sides of the fuselage. Both measurements must be equal. If they are not, reposition the stabilizer and re-measure until both measurements are equal on both sides of the fuselage.

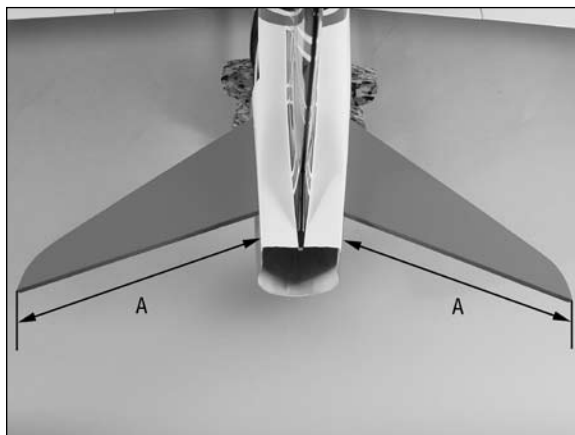

- 11. Measure the distance from the wing tip to the stabilizer tip on both the right and left of the aircraft. Both measurements must be equal. If not, readjust the stabilizer and re-measure until the measurement is the same on both the left and right of the aircraft.

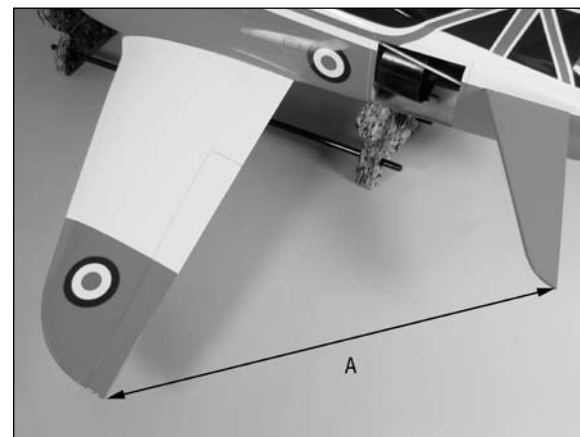
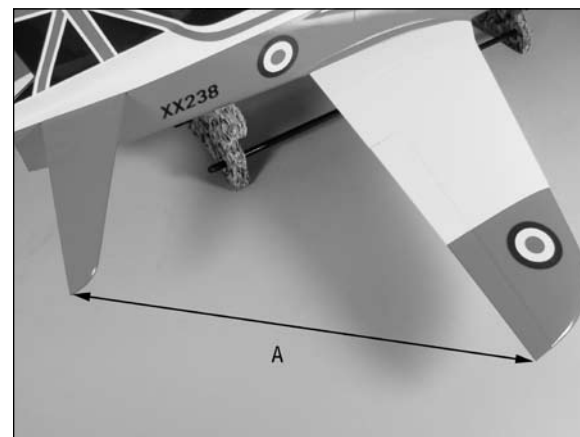

- 12. Step back about 4–5 feet (1.2–1.5 meters) and view the fuselage from the rear. Check that the stabilizer is in alignment with the wing by checking the stabilizer tips against the wing. Both stabilizer tips should align with the wing trailing edge. Adjust the position of the stabilizer if necessary for correct stabilizer alignment.



- 13. Use a felt-tip pen to trace the outline of the fuselage onto the top, bottom, left and right of the stabilizer.



- 15. Carefully use a hobby knife to remove the covering 1/16-inch (1.5mm) from inside the lines. Use light pressure with a new #11 blade to avoid cutting into the underlying wood. You will need to trim the covering from the top and bottom of the stabilizer at this time.

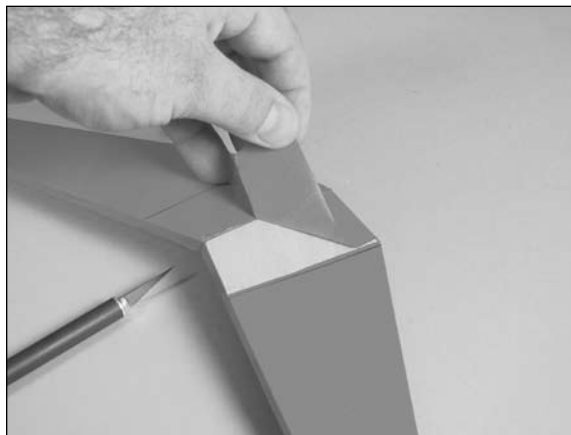

### ***E-tips***

Other options other than a hobby knife are to use a hot knife (with a new blade) or a soldering iron for cutting the covering. These will melt the covering and lower the chances of cutting into the wood structure of the stabilizer.

- 16. Use medium CA to glue the stabilizer to the fuselage. Apply a bead of CA to the joint inside the fuselage, both right and left. Wick thin CA on the top of the stabilizer/fuselage joint by holding the nose down. Use care not to let the CA wick out on the outside of the fuselage or stabilizer.



### ***E-tips***

Use a paper towel and rubbing alcohol to remove the lines from the stabilizer and fuselage before gluing the stabilizer in position.

## Elevator Installation

### Required Parts

Elevator (left and right)  
Elevator control horn (left and right)  
CA hinge (4)

### Required Tools and Adhesives

6-minute epoxy	Mixing cup
Mixing stick	Epoxy brush
Paper towel	Rubbing alcohol
Low-tack tape	Toothpicks
Thin CA	T-pins

- 1. Mix a small amount of 6-minute epoxy. Use a toothpick to apply the epoxy to the slot in the elevator and into the hole drilled in the elevator.



- 2. Apply a thin layer of epoxy on the elevator control wire at this time as well.



### ***E-tips***

Make sure not to apply epoxy near the threaded portion of the elevator control wire.

- 3. Press the elevator control wire into the elevator half. Remove any excess epoxy using a paper towel and rubbing alcohol. Use low-tack tape to hold the wire tightly in position in the elevator.

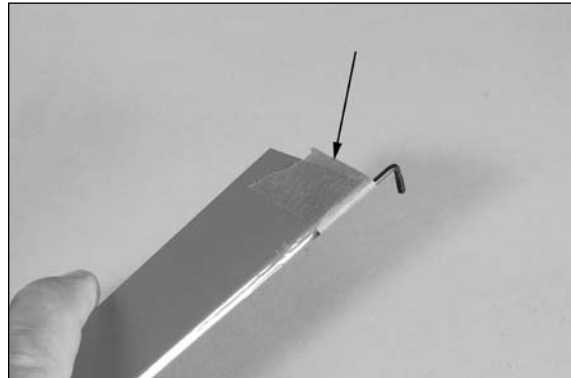

- 4. Repeat Steps 1 through 3 to install the remaining elevator control wire. Make sure to make a left and a right elevator. The threaded end of the control wire should point down toward the bottom of elevator.
- 5. Place a T-pin in the center of two of the elevator hinges. This will help center them equally in the stabilizer and elevator when they are installed.

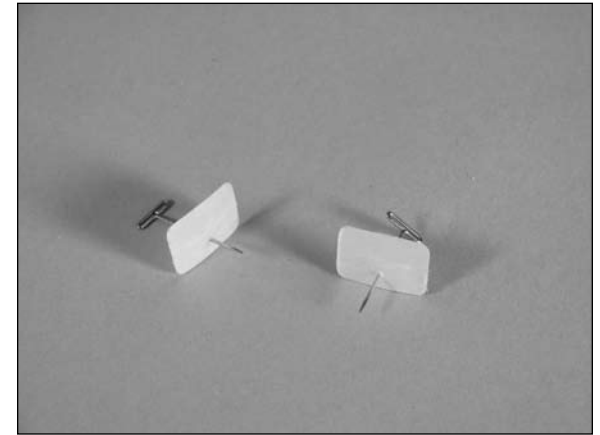

- 6. Slide the two hinges into the slots that have been pre-cut into the elevator.

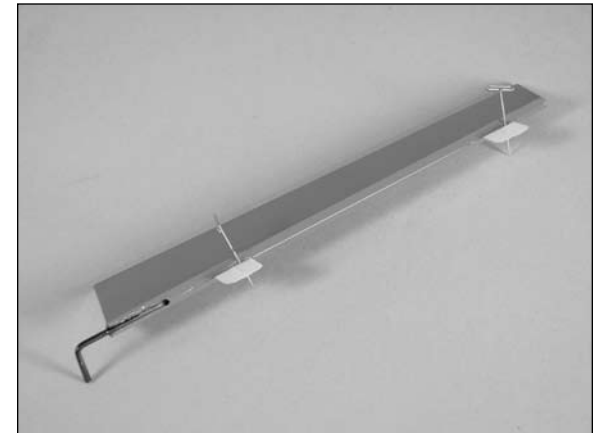

- 7. Insert the control wire into the fuselage first.

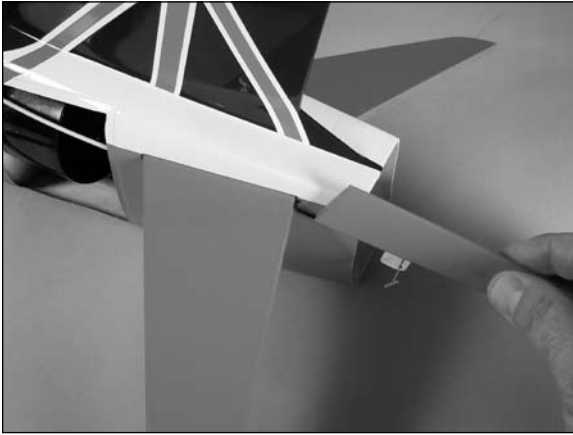

- 8. Rotate the elevator into position. The hinges will now fit into the pre-cut slots in the stabilizer.

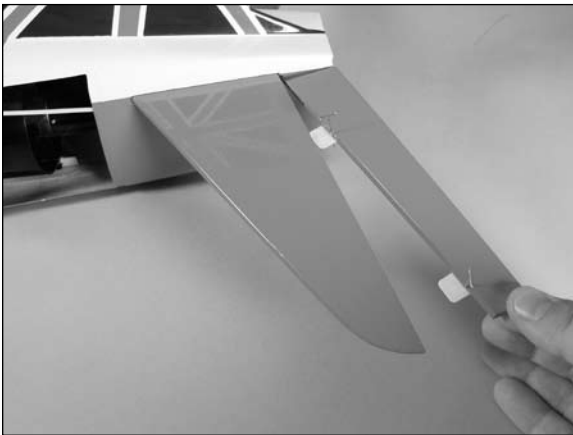

- 9. Before gluing the hinges, make sure the control horn wire is facing the correct direction. They must face down to the bottom of the fuselage or you won't be able to connect the linkages to operate the elevators.

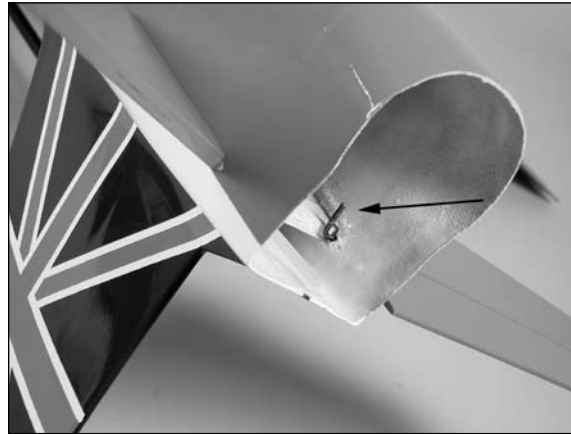

- 10. Position the elevator tight against the stabilizer. There should be just a slight gap between the elevator and the stabilizer. Check that the tips of the elevator and stabilizer align with each other.



- 11. Use thin CA to glue the two hinges. Apply CA to the top and bottom of each hinge, enough that it will fully soak into the hinge.



### ***E-tips***

DO NOT use CA accelerator on the hinges. The CA must be allowed to soak into the hinge to fully penetrate the hinge and surrounding wood. Accelerator will not allow the CA to soak into the hinge and will result in a poor bond between the hinge and surrounding wood.

- 12. Once the CA has fully cured, lightly pull on the elevator and stabilizer to make sure the hinges are secure. If not, apply additional CA to the hinges that are not secure.





- 13. Break in the elevator hinges by moving the elevator through its range of motion a few times. This will help in reducing the initial load on the servo and make the control surfaces easier to move initially.



- 14. Repeat Steps 5 through 13 to install the remaining elevator.

## Elevator Linkage Installation

### Required Parts

- Assembled airframe
- Elevator control horn (2)
- Elevator pushrod keeper (2)
- Elevator pushrod wire, 24<sup>7</sup>/<sub>16</sub>-inch (620mm) (2)

### Required Tools and Adhesives

- Hobby knife w/#11 blade
- Needle-nose pliers
- Medium CA

- 1. Slide the elevator pushrod tube back into position in the fuselage. When the pushrod is in the correct position it will be at the very bottom of the slot in the former.

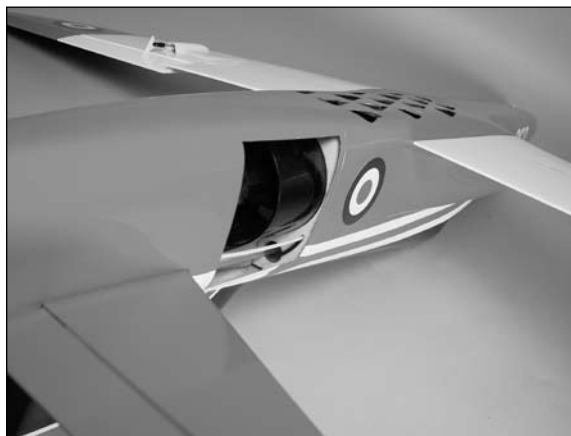

- 2. Tack the pushrod into position on the former with medium CA as you might need to break it loose if maintenance is required to the fan and motor.

- 3. Use a hobby knife to make a slight bevel inside the hole of the elevator control horn. Rotate the hobby knife like a drill to make the bevel even. This will help when installing the control horn onto the elevator control horn wire.

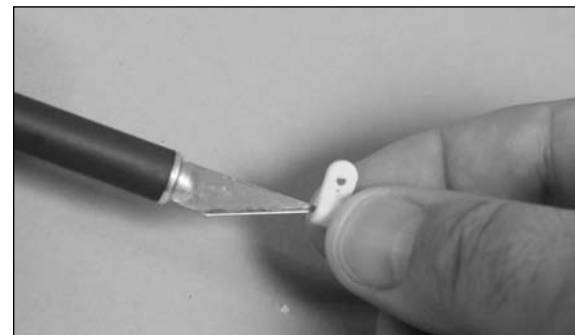

- 4. Thread the elevator control horn onto the elevator control horn wire. The end of each control horn will be flush with the end of the wire as shown in the photo.



- ○ 5. Slide the pushrod keeper onto the elevator pushrod wire. Please note that these are the keepers with the smaller holes in them.

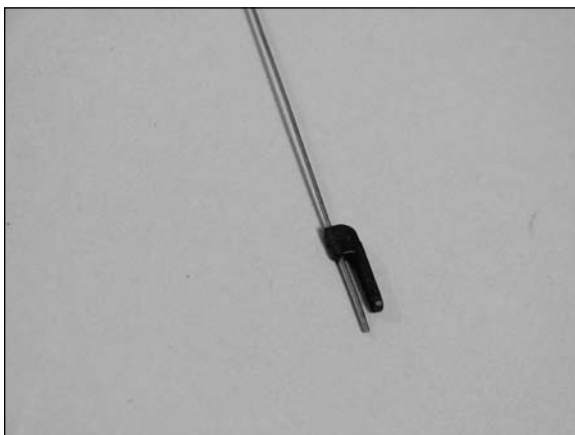

- ○ 6. Use needle-nose pliers to bend the pushrod wire 1/4-inch (6mm) from the end of the wire.

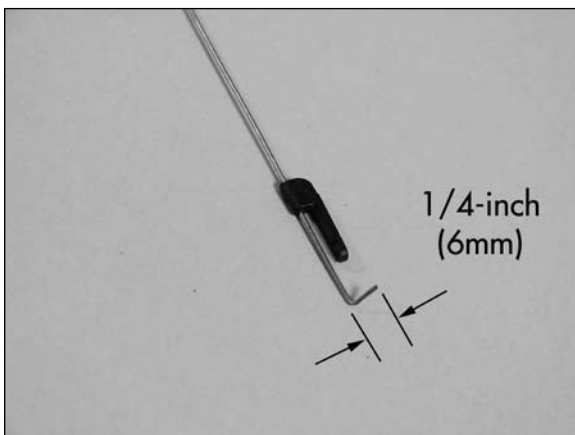

- ○ 7. Slide the elevator pushrod wire into the elevator pushrod tube.



- ○ 8. Connect the pushrod to the elevator control horn by sliding the bend from the pushrod wire into the hole in the elevator control horn. Use the pushrod keeper to secure the wire to the elevator control horn.



- 9. Repeat Steps 3 through 8 to install the remaining elevator control horn and pushrod wire.



## Landing Gear Installation

### Required Parts

- Nose gear wire
- Wheel collar (7)
- Main gear wire, left
- Main gear wire, right
- 3mm x 3mm setscrew
- Landing gear strap (2)
- Nose gear pushrod wire, 7<sup>7</sup>/<sub>8</sub>-inch (200mm)
- Nose gear steering arm
- 2mm x 8mm machine screw (7)
- Nose wheel, 1 <sup>3</sup>/<sub>16</sub>-inch (30mm)
- Main wheel, 1 <sup>5</sup>/<sub>8</sub>-inch (41mm) (2)
- 2mm x 8mm sheet metal screw (4)

### Required Tools and Adhesives

- Phillips screwdriver: #1
- Ruler
- Hex wrench: 1.5mm
- Threadlock

- ○ 1. Use a landing gear strap and two 2mm x 8mm sheet metal screws to secure the main landing gear wire to the bottom of the wing. There is a left and right main gear wire. When positioned correctly the spring coil will face the rear as shown in the second photo.

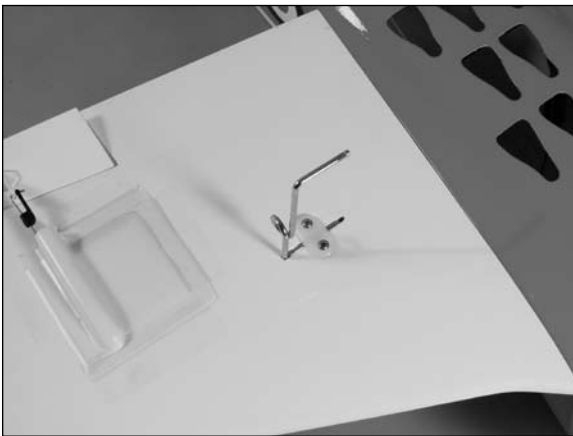

- ○ 2. Slide a wheel collar on the main landing gear and use a #1 Phillips screwdriver and 2mm x 8mm machine screw to secure the wheel collar to the wire. The wheel collars have a slight flange which faces toward the wheel. Make sure to install the wheel collars in the correct direction.



**E-tips**

Always use threadlock on metal-to-metal fasteners to prevent them from vibrating loose.

- ○ 3. Slide a main wheel and wheel collar onto the landing gear wire. Use a #1 Phillips screwdriver and 2mm x 8mm machine screw to secure the wheel. Remember to use threadlock on the screw to prevent it from vibrating loose.



**E-tips**

Leave a very small gap between the wheels and each collar to allow the wheel to roll freely.

- 4. Repeat Steps 1 through 3 to install the remaining main gear wire and wheel.

- 5. Position the wheel collar on the nose gear wire so it is  $2\frac{5}{16}$ -inch (57mm) from the axle as shown. Use a #1 Phillips screwdriver and 2mm x 8mm machine screw to secure the position of the wheel collar. Note that the flange on the collar faces away from the spring on the nose gear wire.

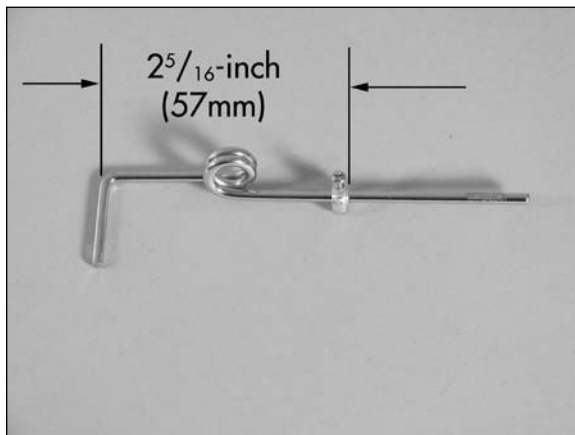

- 6. Install the nose wheel on the nose gear wire using two wheels collar and a #1 Phillips screwdriver to tighten the two 2mm x 8mm machine screws.

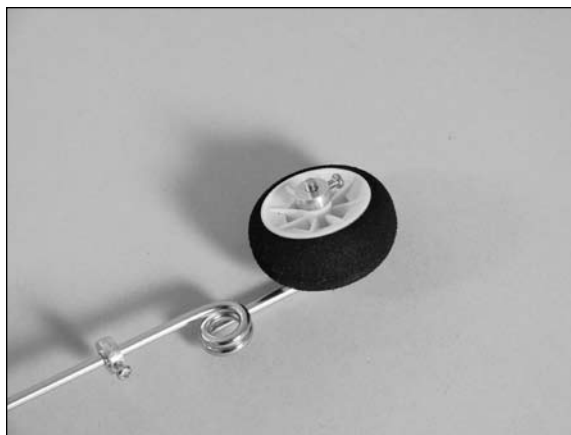
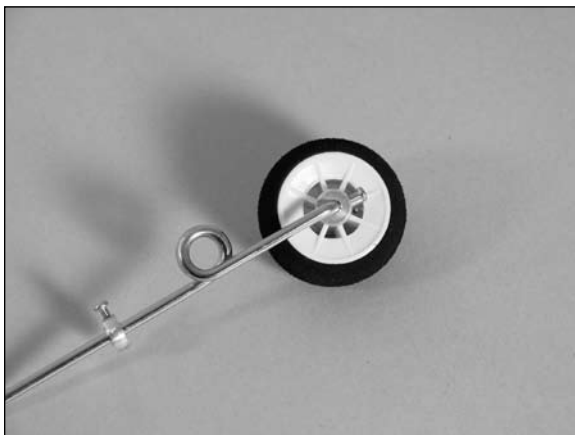

- 7. Slide the nose gear wire into the bushing in the front of the fuselage.



**E-tips**

During manufacturing the end of the nose gear wire may be slightly enlarged due to cutting. If this happens use a file to reduce the diameter of the end of the wire so that it will slide smoothly through the bushings.

- 8. Insert the Z-bend from the nose gear pushrod wire into the steering bell crank.



- 9. Slide the steering bell crank on the nose gear wire from inside the fuselage. Use a 1.5mm hex wrench and 3mm x 3mm setscrew to secure the steering arm to the nose gear wire. Make sure to use threadlock on the setscrew to prevent it from vibrating loose.



**E-tips**

Check to make sure the nose gear wire can move freely so the steering servo is not overloaded when trying to steer your aircraft.

## Nose Gear and Elevator Servo Installation

### Required Parts

Radio system      Assembled airframe  
Pushrod connector (2)  
Servo w/hardware (2)  
2x4mm machine screw (2)  
Servo arm, single-sided (2)  
3-inch (76mm) servo extension (2)  
2mm nut (2) #2 washer (2) (optional)

### Required Tools and Adhesives

Pencil      Thin CA  
Pin drill      Phillips screwdriver: #1  
String/dental floss      Drill bit: 5/64-inch (2mm)  
Side cutters

- 1. Secure a 3-inch (76mm) servo extension to the steering servo. Use dental floss to secure the connectors together. Use a #0 Phillips screwdriver to remove the servo arm from the servo.



- 2. Position the elevator servo in the fuselage with the output of the servo facing toward the elevators. Use a pencil to mark the locations for the two servo mounting screws onto the radio tray.



- 3. Remove the servo and use a pin drill and 1/16-inch (1.5mm) drill bit to drill the two holes for the servo mounting screws.



- 4. Place 2-3 drops of thin CA into each hole to harden the surrounding wood. This will provide a harder surface for the screws to bite into, making them more secure.



- 5. Secure the elevator servo using the two screws that were provided with the servo.





- 6. The installation of the steering servo is the same as the elevator servo. Repeat Steps 1 through 5 to install the steering servo in the fuselage. Make sure the output shaft of the steering servo faces the front of the fuselage.



- 7. Use a pin drill and 1/16-inch (2mm) drill bit to enlarge the second hole from center of a single-sided servo arm.



- 8. Insert the pushrod connector into the hole. You may need to enlarge the hole slightly using a hobby knife w/#11 blade so the connector can rotate freely.

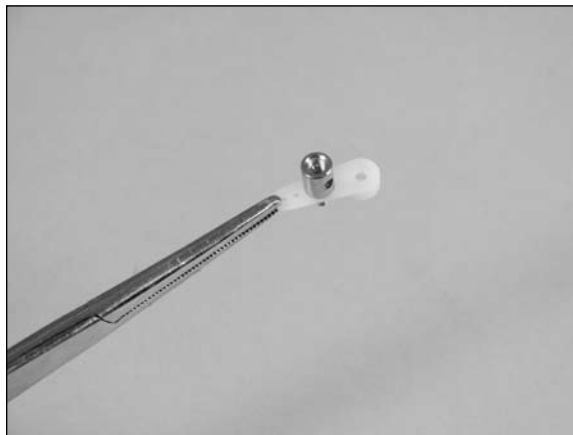

- 9. Secure the pushrod connector using a 2mm nut. Use threadlock on the nut to prevent it from vibrating loose in flight. If you find excessive play between the pushrod connector and servo arm you can use one of the provided 2mm washers to take up the excess space before installing the nut. The nut should bottom out on the threads and be tight so it will not come loose.

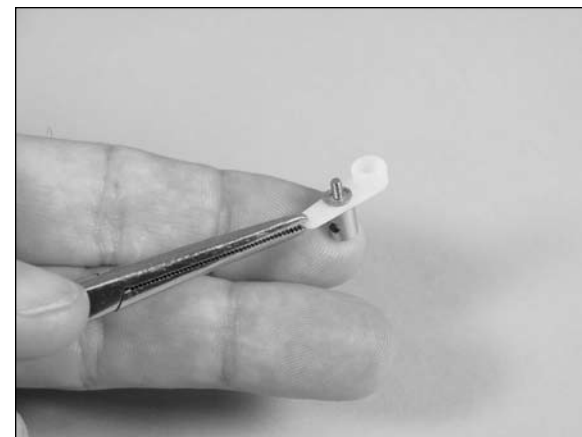
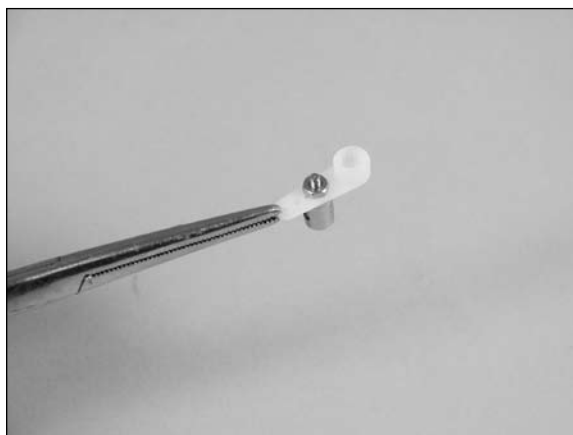

- 10. Center the elevator servo using the radio system. Route both elevator pushrods through the connector. Secure the servo arm to the elevator servo using the screw provided with the servo and a #0 Phillips screwdriver.



- ○ 11. Check that both the left and right elevators are centered and equal to each other.

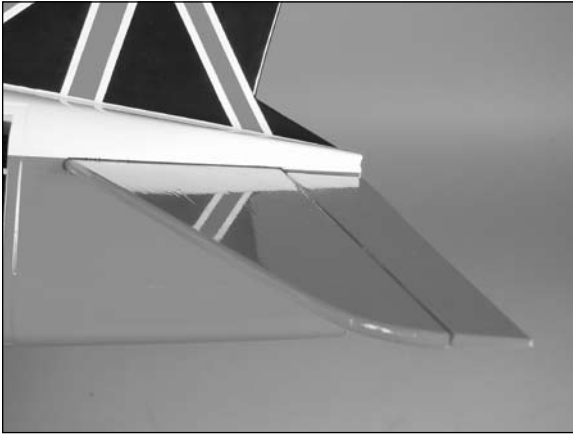

- ○ 12. Use a #1 Phillips screwdriver and 2mm x 4mm machine screw to secure the elevator pushrod wires in the pushrod connector. Use side cutters to remove any excess pushrod wire. Save the pushrod wire remains for later in the assembly of your aircraft.



- 13. Repeat Steps 7 through 12 for the steering servo arm, only enlarging the third hole from center as shown.

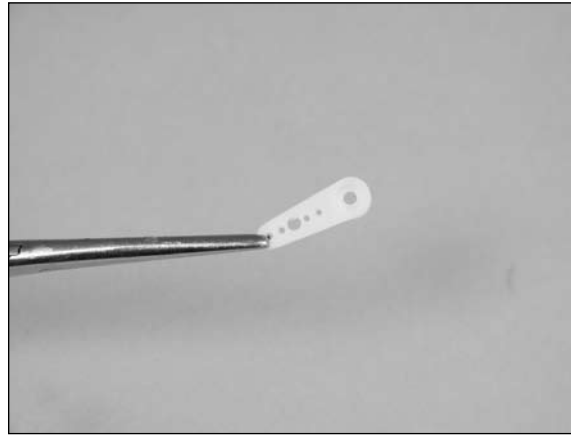

- 14. Before securing the steering pushrod with a 2mm x 4mm machine screw and #1 Phillips screwdriver, make sure that the nose gear has been centered so your aircraft will taxi straight on the runway.

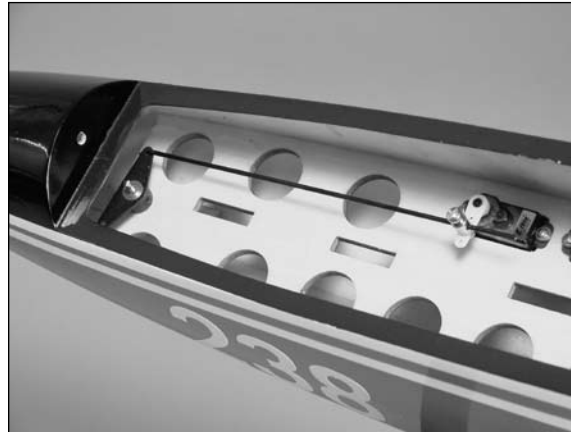

***Etips***

Check to make sure the nose gear wire can move freely so the steering servo is not overloaded when trying to steer your aircraft.

## ***Speed Control and Receiver Installation***

### ***Required Parts***

Assembled airframe  
 Speed control      Receiver  
 Hook and loop tape

### ***Required Tools and Adhesives***

Phillips screwdriver: #0, #1  
 Pin drill      Drill bit: 1/16-inch (1.5mm)  
 Hobby knife w/#11 blade  
 Side cutters

- 1. Cut a piece of hook and loop tape and apply it to the bottom of the speed control as shown. Leave the adhesive backing on the mating hook and loop until instructed to do so.



- 2. Allow the speed control to “fall” into the fuselage. Pull the motor wires from the speed control and those from the fan motor through one of the intake holes. Plug the wires together then insert the wires back into the fuselage.

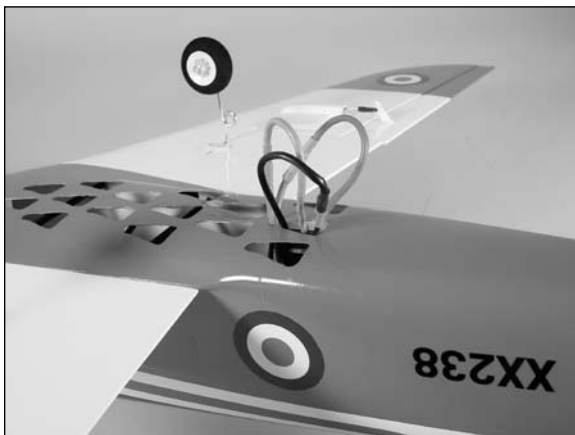

- 3. Remove the backing from the hook and loop tape on the speed control. Secure the speed control inside the fuselage as shown.



- 4. Plug the leads from the aileron servos, elevator servo, steering servo and speed control into the appropriate ports of the receiver. Use hook and loop tape to attach the receiver inside the fuselage as shown in the photo.

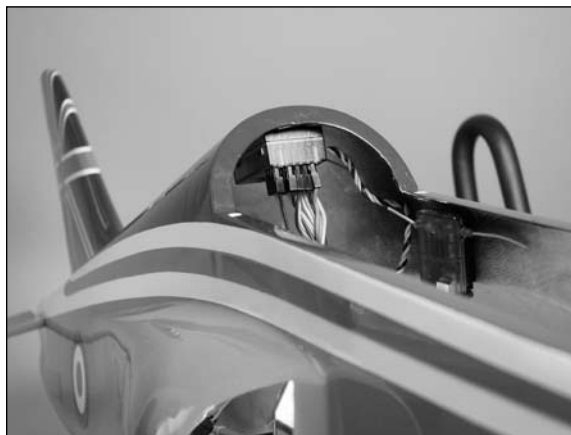

### ***E-tips***

When using a 72MHz receiver, you will need to route the antenna wire to the rear of the fuselage. A tube has been installed in the fuselage near the elevator pushrod tubes for this purpose. Never cut the antenna wire as it can greatly reduce the range of your radio system.

- 5. When installing a remote receiver, attach it as shown in the fuselage using hook and loop tape.



## ***Canopy Installation***

### ***Required Parts***

Assembled airframe  
 Rubber band      Eye hook (2)  
 Canopy            Pushrod wire remains

### ***Required Tools and Adhesives***

Needle-nose pliers    Thin CA

- 1. Thread the eye hook into the radio tray as shown. An indentation has been made in the radio tray to indicate the correct locations for the eye hook.



- 2. Thread the eye hook into the canopy floor as shown. An indentation has been made in the canopy floor to indicate the correct locations for the eye hook. Once the eye hooks are installed, use thin CA to secure the joint.

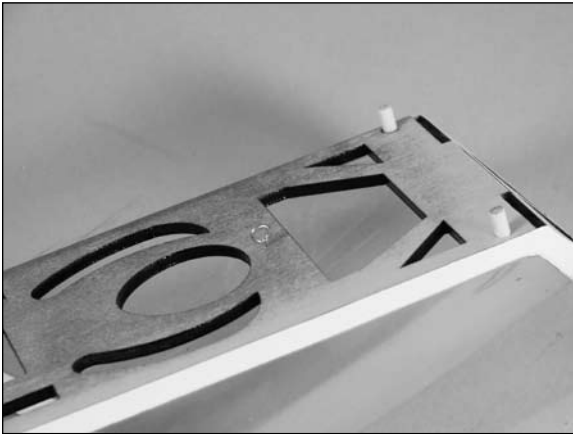

- 3. Slide a rubber band through the eye hook as shown in the photo.

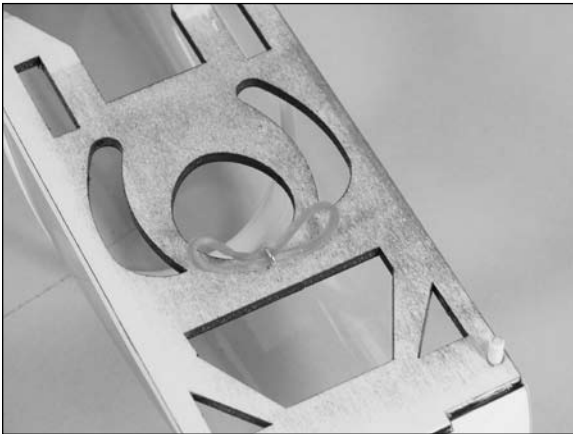

- 4. Use a piece of pushrod wire and needle-nose pliers to bend a small hook. Attach the hook to the rubber band as shown in the photo below.



- 5. Connect the hook from the rudder band to the eye hook installed on the radio tray in Step 1. Insert the pins from the front of the canopy into the holes in the fuselage, and the rubber band will hold the canopy secure on the fuselage.



## Optional Pilots

You may notice that we have pilots in the BAe hawk. These are not included with the kit. They can be purchased separately under part number (PKZ4414). The pilots were cut down to fit and were glued in with canopy glue as shown.

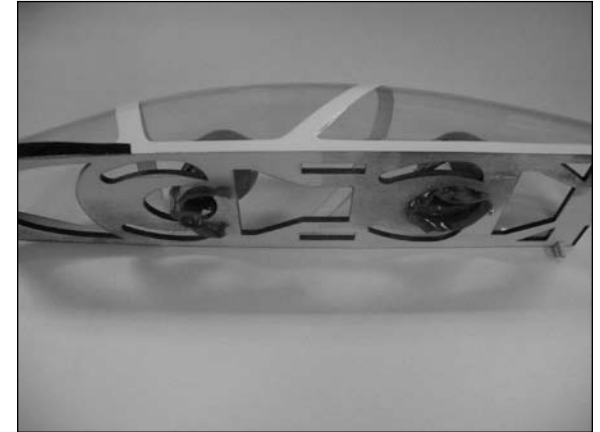

## Thrust Tube Installation

### Required Parts

Assembled airframe  
Thrust tube            Clear tape  
Fan access hatch

### Required Tools and Adhesives

Scissors

- 1. Carefully roll or fold the thrust tube into the shape shown below. It is made of Lexan and will not be harmed by doing so.

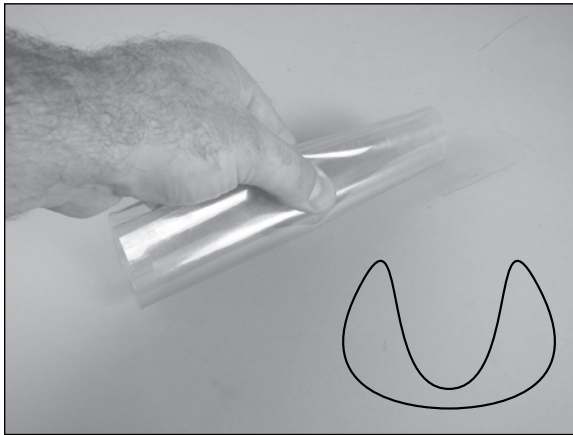

- 2. Slide the thrust tube into the fuselage, with the wider end of the tube entering the fuselage from the rear. It will “pop” open when it has been inserted fully into the fuselage.

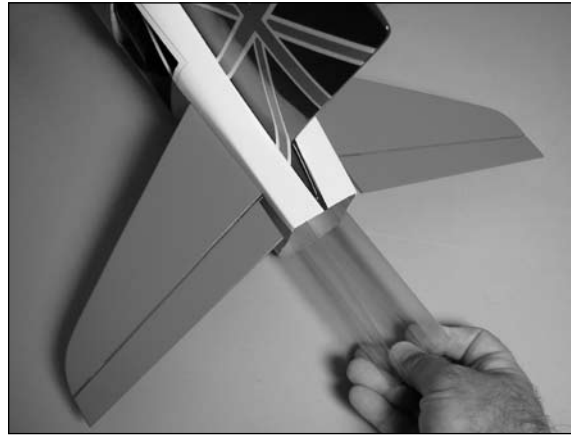

- 3. Position the thrust tube so it overlaps onto the fan assembly. It will also fit flush with the end of the fuselage when positioned correctly. Use the clear tape supplied with your aircraft to tape the thrust tube to the fan housing.

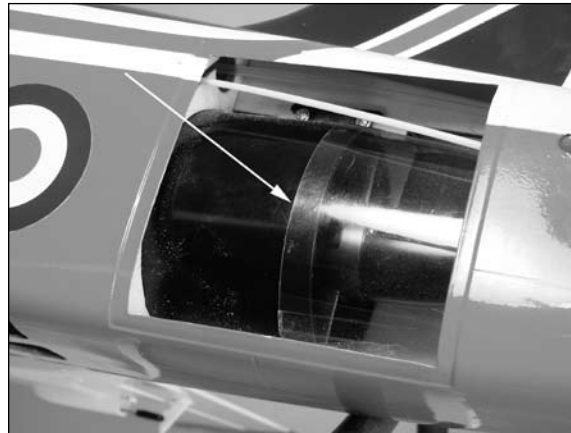

- 4. Use clear tape at the bottom and both sides of the thrust tube to secure the tube at the rear of the fuselage.

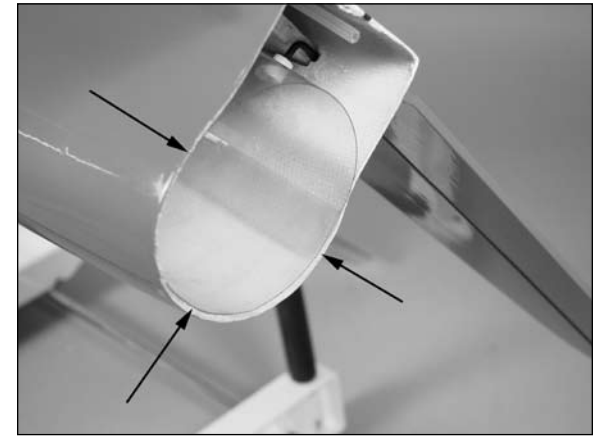

- 5. Cut four pieces of clear tape using scissors and tape the fan access hatch to the fuselage.





## Motor Battery Installation

### Required Parts

Assembled airframe  
Hook and loop strap  
Motor battery

### Required Tools and Adhesives

Scissors

- 1. Overlap the hook and loop strap as shown. Use scissors to cut the strap in half down the middle.

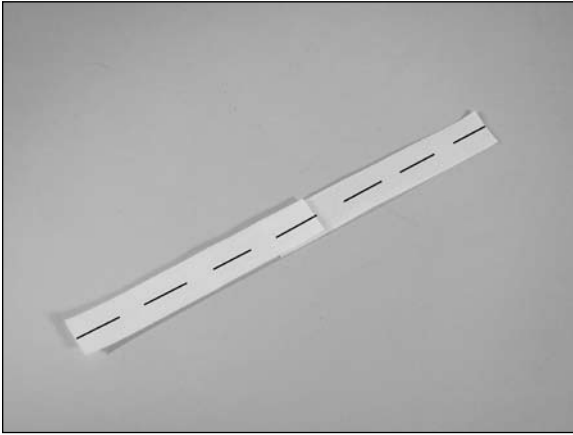

- 2. Slide the strap through the slots in the battery/radio tray as shown.



- 3. Position the motor battery in the fuselage and use the hook and loop strap to secure it inside the fuselage.



**E-tips**

You may have to remove the excess part of the servo arm on the elevator and the steering servo for clearance of the main battery.

## Accessory Installation

### Required Parts

Wing tip plate (2) Air intake scoop (2)

### Required Tools and Adhesives

Canopy glue Low-tack tape

- 1. The wing tip plates are glued in position using canopy glue. The longer section of the plate will be on the top of the wing. Insert the pin in the plate into the pre-drilled hole in the leading edge of the wing. Use low-tack tape to hold the plate in position until the glue has fully cured. Try to keep the wing fences as parallel to the flight path as possible while the glue dries.

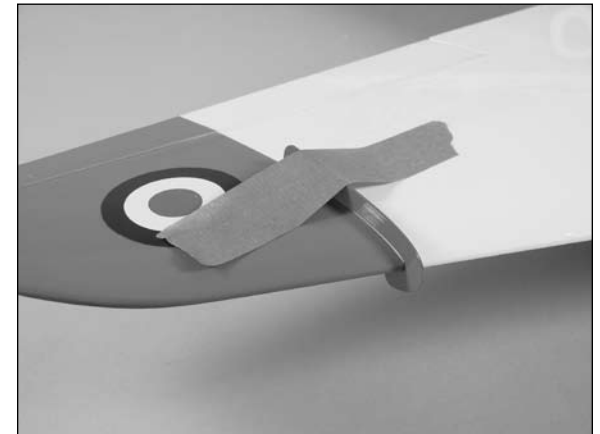



- 2. Use hobby scissors to trim the air intake scoop as shown. The intake on the right is uncut, while the one on the left has been fully trimmed and is ready to install. Leave about 1/16-inch (1.5mm) around the intakes for a better gluing base.



### ***E-tips***

Use a black felt-tip marker to detail the front opening of the intake to add realism to your model.

- 3. Use canopy glue and low-tack tape to glue and hold the air intake scoops in position until the glue can fully cure.



## ***Control Throws***

- 1. Turn on the transmitter and receiver of your BAe Hawk. Check the movement of the rudder using the transmitter. When the stick is moved right, the rudder should also move right. Reverse the direction of the servo at the transmitter if necessary.
- 2. Check the movement of the elevator with the radio system. Moving the elevator stick down will make the airplane elevator move up.
- 3. Check the movement of the ailerons with the radio system. Moving the aileron stick right will make the right aileron move up and the left aileron move down.
- 4. Use a ruler to adjust the throw of the elevator, ailerons and rudder. Adjust the position of the pushrod at the control horn to achieve the following measurements when moving the sticks to their endpoints.

### Aileron High Rate

Up 5/16-inch (8mm)  
Down 3/16-inch (5mm)

### Aileron Low Rate

Up 1/4-inch (6mm)  
Down 5/32-inch (4mm)

### Elevator High Rate

Up 5/16-inch (8mm)  
Down 5/16-inch (8mm)

### Elevator Low Rate

Up 3/16-inch (5mm)  
Down 3/16-inch (5mm)

**Note:** Measurements are taken at the inner or widest point on the control surface.

### Nose Wheel Steering (High Rate or Taxi)

Left 3/16-inch (5mm)  
Right 3/16-inch (5mm)

### Nose Wheel Steering (Low Rate or Takeoff)

Left 1/8-inch (3mm)  
Right 1/8-inch (3mm)

**Note:** Steering measurement is taken from the actuation point on the servo arm.

These are general guidelines measured from our own flight tests. You can experiment with higher rates to match your preferred style of flying.

## E-tips

Travel Adjust, Sub Trim and Dual Rates are not listed and should be adjusted according to each individual model and preference.

## Center of Gravity

An important part of preparing the aircraft for flight is properly balancing the model.

**Caution: Do not inadvertently skip this step!**

The recommended Center of Gravity (CG) location for the BAe Hawk is  $3\frac{1}{8}$  to  $3\frac{9}{16}$ -inch (80 to 90mm) back from the leading edge of the wing. Mark the location for the Center of Gravity on the top of the wing next to the fuselage as shown.

When balancing your BAe Hawk, support the plane inverted at the marks made on the top of the wing with your fingers or a commercially available balancing stand. Adjust components as necessary so the model hangs level or slightly nose down. This is the correct balance point for your model. You might find you may be required to add a small amount of weight to either the front or back of the fuselage to achieve the correct balance.

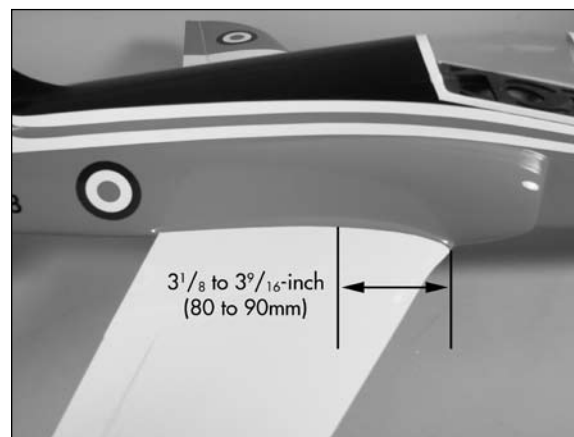

After the first flights, the CG position can be adjusted for your personal preference.

## Preflight

### Check Your Radio

Before going to the field, be sure that your batteries are fully charged per the instructions included with your radio. Charge both the transmitter and receiver pack for your airplane. Use the recommended charger supplied with your particular radio system, following the instructions provided with the radio. In most cases, the radio should be charged the night before going out flying.

Before each flying session, be sure to range check your radio. See your radio manual for the recommended range and instructions for your radio system. Each radio manufacturer specifies different procedures for their radio systems. Next, start the motor. With the model securely anchored, check the range again. The range test should not be significantly affected. If it is, don't attempt to fly! Have your radio equipment checked out by the manufacturer.

**Note:** Keep loose items that can get entangled in the propeller away from the prop. These include loose clothing, or other objects such as pencils and screwdrivers. Especially keep your hands away from the propeller.

Double-check that all controls (aileron, elevator, rudder and throttle) move in the correct direction.

Check the radio installation and make sure all the control surfaces are moving correctly (i.e. the correct direction and with the recommended throws). Test run the motor and make sure it transitions smoothly from off to full throttle and back. Also ensure the engine is installed according to the manufacturer's instructions, and it will operate consistently.

Check all the control horns, servo horns, and clevises to make sure they are secure and in good condition. Replace any items that would be considered questionable. Failure of any of these components in flight would mean the loss of your aircraft.

## Range Test Your Radio

---

- 1. Before each flying session, be sure to range check your radio. This is accomplished by turning on your transmitter with the antenna collapsed. Turn on the receiver in your airplane. With your airplane on the ground and the engine running, you should be able to walk 30 paces (approximately 100 feet) away from your airplane and still have complete control of all functions.

If not, don't attempt to fly! Have your radio equipment checked out by the manufacturer.

- 2. Double-check that all controls (aileron, elevator, rudder and throttle) move in the correct direction.
- 3. Be sure that your transmitter batteries are fully charged, per the instructions included with your radio.

## Flying Your BAe Hawk

---

Flying the BAe Hawk is an exciting treat. Enjoy flying smooth and graceful maneuvers as you enjoy the flight characteristics of the BAe Hawk. You will find that the agile BAe Hawk is very capable in the air yet docile on approach and landings.

If you elect to fly the BAe Hawk without the landing gear, you will need to hand launch the model. We highly recommend that this is done by an assistant, as it requires a steady and strong throw. Launch the model with full power and a slightly nose high attitude.

When using the landing gear, we suggest using the lower rate throws listed in the control throws section for the nose gear on takeoff and landing for smoother and easier high speed ground handling. Line the model up pointing into the wind and apply full power. Hold a small amount of up elevator. The BAe Hawk will rotate smoothly around 200 feet. After rotation, ease off of the up elevator and climb to altitude.

The BAe Hawk tracks very well in the air and is capable of many basic aerobatic maneuvers like loops, rolls, and inverted flight. We do recommend that you use throttle management during the whole flight. Using full power throughout the duration of the flight will result in shorter flight times and could result in a shorter life span for the electronics and batteries. Once you are ready to land, pull the power back and begin a slightly nose-high approach using throttle to control your descent. You will find that the BAe Hawk is a very clean airframe and likes to float. The BAe Hawk will land at a slightly nose high angle and roll out down the runway.

Happy Landings!

## Safety, Precautions and Warnings

---

As the user of this product, you are solely responsible for operating it in a manner that does not endanger yourself and others or result in damage to the product or the property of others.

Carefully follow the directions and warnings for this and any optional support equipment (chargers, rechargeable battery packs, etc.) that you use. This model is controlled by a radio signal that is subject to interference from many sources outside your control. This interference can cause momentary loss of control so it is necessary to always keep a safe distance in all directions around your model, as this margin will help to avoid collisions or injury.

- Always operate your model in an open area away from cars, traffic or people.
- Avoid operating your model in the street where injury or damage can occur.
- Never operate the model out into the street or populated areas for any reason.
- Never operate your model with low transmitter batteries.
- Carefully follow the directions and warnings for this and any optional support equipment (chargers, rechargeable battery packs, etc.) that you use.
- Keep all chemicals, small parts and anything electrical out of the reach of children.
- Moisture causes damage to electronics. Avoid water exposure to all equipment not specifically designed and protected for this purpose.

## Warranty Information

---

### Warranty Period

---

Horizon Hobby, Inc., (Horizon) warrants that the Products purchased (the "Product") will be free from defects in materials and workmanship at the date of purchase by the Purchaser.

## Limited Warranty

---

(a) This warranty is limited to the original Purchaser ("Purchaser") and is not transferable. REPAIR OR REPLACEMENT AS PROVIDED UNDER THIS WARRANTY IS THE EXCLUSIVE REMEDY OF THE PURCHASER. This warranty covers only those Products purchased from an authorized Horizon dealer. Third party transactions are not covered by this warranty. Proof of purchase is required for warranty claims. Further, Horizon reserves the right to change or modify this warranty without notice and disclaims all other warranties, express or implied.

(b) Limitations- HORIZON MAKES NO WARRANTY OR REPRESENTATION, EXPRESS OR IMPLIED, ABOUT NON-INFRINGEMENT, MERCHANTABILITY OR FITNESS FOR A PARTICULAR PURPOSE OF THE PRODUCT. THE PURCHASER ACKNOWLEDGES THAT THEY ALONE HAVE DETERMINED THAT THE PRODUCT WILL SUITABLY MEET THE REQUIREMENTS OF THE PURCHASER'S INTENDED USE.

(c) Purchaser Remedy- Horizon's sole obligation hereunder shall be that Horizon will, at its option, (i) repair or (ii) replace, any Product determined by Horizon to be defective. In the event of a defect, these are the Purchaser's exclusive remedies. Horizon reserves the right to inspect any and all equipment involved in a warranty claim. Repair or replacement decisions are at the sole discretion of Horizon. This warranty does not cover cosmetic damage or damage due to acts of God, accident, misuse, abuse, negligence, commercial use, or modification of or to any part of the Product. This warranty does not cover damage due to improper installation, operation, maintenance, or attempted repair by anyone other than Horizon. Return of any goods by Purchaser must be approved in writing by Horizon before shipment.

## Damage Limits

---

HORIZON SHALL NOT BE LIABLE FOR SPECIAL, INDIRECT OR CONSEQUENTIAL DAMAGES, LOSS OF PROFITS OR PRODUCTION OR COMMERCIAL LOSS IN ANY WAY CONNECTED WITH THE PRODUCT, WHETHER SUCH CLAIM IS BASED IN CONTRACT, WARRANTY, NEGLIGENCE, OR STRICT LIABILITY. Further, in no event shall the liability of Horizon exceed the individual price of the Product on which liability is asserted. As Horizon has no control over use, setup, final assembly, modification or misuse, no liability shall be assumed nor accepted for any resulting damage or injury. By the act of use, setup or assembly, the user accepts all resulting liability. If you as the Purchaser or user are not prepared to accept the liability associated with the use of this Product, you are advised to return this Product immediately in new and unused condition to the place of purchase.

Law: These Terms are governed by Illinois law (without regard to conflict of law principals).

## Safety Precautions

---

This is a sophisticated hobby Product and not a toy. It must be operated with caution and common sense and requires some basic mechanical ability. Failure to operate this Product in a safe and responsible manner could result in injury or damage to the Product or other property. This Product is not intended for use by children without direct adult supervision. The Product manual contains instructions for safety, operation and maintenance. It is essential to read and follow all the instructions and warnings in the manual, prior to assembly, setup or use, in order to operate correctly and avoid damage or injury.

## Questions, Assistance, and Repairs

---

Your local hobby store and/or place of purchase cannot provide warranty support or repair. Once assembly, setup or use of the Product has been started, you must contact Horizon directly. This will enable Horizon to better answer your questions and service you in the event that you may need any assistance. For questions or assistance, please direct your email to [productsupport@horizonhobby.com](mailto:productsupport@horizonhobby.com), or call 877.504.0233 toll free to speak to a service technician.

## Inspection or Repairs

---

If this Product needs to be inspected or repaired, please call for a Return Merchandise Authorization (RMA). Pack the Product securely using a shipping carton. Please note that original boxes may be included, but are not designed to withstand the rigors of shipping without additional protection. Ship via a carrier that provides tracking and insurance for lost or damaged parcels, as **Horizon is not responsible for merchandise until it arrives and is accepted at our facility**. A Service Repair Request is available at [www.horizonhobby.com](http://www.horizonhobby.com) on the "Support" tab. If you do not have internet access, please include a letter with your complete name, street address, email address and phone number where you can be reached during business days, your RMA number, a list of the included items, method of payment for any non-warranty expenses and a brief summary of the problem. Your original sales receipt must also be included for warranty consideration. Be sure your name, address, and RMA number are clearly written on the outside of the shipping carton.

## Warranty Inspection and Repairs

---

**To receive warranty service, you must include your original sales receipt** verifying the proof-of-purchase date. Provided warranty conditions have been met, your Product will be repaired or replaced free of charge. Repair or replacement decisions are at the sole discretion of Horizon Hobby.

## Non-Warranty Repairs

**Should your repair not be covered by warranty the repair will be completed and payment will be required without notification or estimate of the expense unless the expense exceeds 50% of the retail purchase cost.** By submitting the item for repair you are agreeing to payment of the repair without notification. Repair estimates are available upon request. You must include this request with your repair. Non-warranty repair estimates will be billed a minimum of ½ hour of labor. In addition you will be billed for return freight. Please advise us of your preferred method of payment. Horizon accepts money orders and cashiers checks, as well as Visa, MasterCard, American Express, and Discover cards. \If you choose to pay by credit card, please include your credit card number and expiration date. Any repair left unpaid or unclaimed after 90 days will be considered abandoned and will be disposed of accordingly. **Please note: non-warranty repair is only available on electronics and model engines.**

Electronics and engines requiring inspection or repair should be shipped to the following address:

Horizon Service Center  
4105 Fieldstone Road  
Champaign, Illinois 61822

or

Horizon Hobby UK  
Units 1-4, Ployters Road  
Staple Tye  
Harlow, Essex  
CM187NS

United Kingdom

or

Horizon Technischer Service  
Otto-Hahn-Str. 9a  
25337 Elmshorn  
Germany

**USA: Please call 1 877 504 0233 or visit [horizonhobby.com](http://horizonhobby.com) to find our distributor for your country for support with any questions or concerns regarding this product or warranty.**

**UK: Please call +44 (0) 1279 641 097 or email [sales@horizonhobby.co.uk](mailto:sales@horizonhobby.co.uk) with any questions or concerns regarding this product or warranty.**

**Germany: Please call +49 4121 46199 66 or email [service@horizonhobby.de](mailto:service@horizonhobby.de) with any questions or concerns regarding this product or warranty.**

## Instructions for Disposal of WEEE by Users in the European Union

This product must not be disposed of with other waste. Instead, it is the user's responsibility to dispose of their waste equipment by handing it over to a designated collection point for the recycling of waste electrical and electronic equipment. The separate collection and recycling of your waste equipment at the time of disposal will help to conserve natural resources and ensure that it is recycled in a manner that protects human health and the environment. For more information about where you can drop off your waste equipment for recycling, please contact your local city office, your household waste disposal service or where you purchased the product.

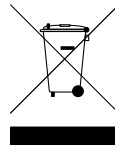

# 2008 Official Academy of Model Aeronautics Safety Code

## GENERAL

1. A model aircraft shall be defined as a non-human-carrying device capable of sustained flight in the atmosphere. It shall not exceed limitations established in this code and is intended to be used exclusively for recreational or competition activity.
2. The maximum takeoff weight of a model aircraft, including fuel, is 55 pounds, except for those flown under the AMA Experimental Aircraft Rules.
3. I will abide by this Safety Code and all rules established for the flying site I use. I will not willfully fly my model aircraft in a reckless and/or dangerous manner.
4. I will not fly my model aircraft in sanctioned events, air shows, or model demonstrations until it has been proven airworthy.
5. I will not fly my model aircraft higher than approximately 400 feet above ground level, when within three (3) miles of an airport without notifying the airport operator. I will yield the right-of-way and avoid flying in the proximity of full-scale aircraft, utilizing a spotter when appropriate.
6. I will not fly my model aircraft unless it is identified with my name and address, or AMA number, inside or affixed to the outside of the model aircraft. This does not apply to model aircraft flown indoors.
7. I will not operate model aircraft with metal-blade propellers or with gaseous boosts (other than air), nor will I operate model aircraft with fuels containing tetranitromethane or hydrazine.
8. I will not operate model aircraft carrying pyrotechnic devices which explode burn, or propel a projectile of any kind. Exceptions include Free Flight fuses or devices that burn producing smoke and are securely attached to the model aircraft during flight. Rocket motors up to a G-series size may be used, provided they remain firmly attached to the model aircraft during flight. Model rockets may be flown in accordance with the National Model Rocketry Safety Code; however, they may not be launched from model aircraft. Officially designated AMA Air Show Teams (AST)

are authorized to use devices and practices as defined within the Air Show Advisory Committee Document.

9. I will not operate my model aircraft while under the influence of alcohol or within eight (8) hours of having consumed alcohol.
10. I will not operate my model aircraft while using any drug which could adversely affect my ability to safely control my model aircraft.
11. Children under six (6) years old are only allowed on a flightline or in a flight area as a pilot or while under flight instruction.
12. When and where required by rule, helmets must be properly worn and fastened. They must be OSHA, DOT, ANSI, SNELL or NOCSAE approved or comply with comparable standards.

## RADIO CONTROL

1. All model flying shall be conducted in a manner to avoid over flight of unprotected people.
2. I will have completed a successful radio equipment ground-range check before the first flight of a new or repaired model aircraft.
3. I will not fly my model aircraft in the presence of spectators until I become a proficient flier, unless I am assisted by an experienced pilot.
4. At all flying sites a line must be established, in front of which all flying takes place. Only personnel associated with flying the model aircraft are allowed at or in front of the line. In the case of airshows demonstrations straight line must be established. An area away from the line must be maintained for spectators. Intentional flying behind the line is prohibited.
5. I will operate my model aircraft using only radio-control frequencies currently allowed by the Federal Communications Commission (FCC). Only individuals properly licensed by the FCC are authorized to operate equipment on Amateur Band frequencies.
6. I will not knowingly operate my model aircraft within three (3) miles of any preexisting flying site without a frequency-management agreement. A frequencymanagement agreement may be an allocation of frequencies for each site, a day-use agreement between sites, or testing which determines that no interference exists. A frequency-

management agreement may exist between two or more AMA chartered clubs, AMA clubs and individual AMA members, or individual AMA members. Frequency-management agreements, including an interference test report if the agreement indicates no interference exists, will be signed by all parties and copies provided to AMA Headquarters.

7. With the exception of events flown under official AMA rules, no powered model may be flown outdoors closer than 25 feet to any individual, except for the pilot and located at the flightline.
8. Under no circumstances may a pilot or other person touch a model aircraft in flight while it is still under power, except to divert it from striking an individual.
9. Radio-controlled night flying is limited to low-performance model aircraft (less than 100 mph). The model aircraft must be equipped with a lighting system which clearly defines the aircraft's attitude and direction at all times.
10. The operator of a radio-controlled model aircraft shall control it during the entire flight, maintaining visual contact without enhancement other than by corrective lenses that are prescribed for the pilot. No model aircraft shall be equipped with devices which allow it to be flown to a selected location which is beyond the visual range of the pilot.

## PARK FLYER SAFE OPERATING RECOMMENDATIONS

- Inspect your model before every flight to make certain it is airworthy.
- Be aware of any other radio frequency user who may present an interference problem.
- Always be courteous and respectful of other users of your selected flight area.
- Choose an area clear of obstacles and large enough to safely accommodate your flying activity.
- Make certain this area is clear of friends and spectators prior to launching your aircraft.
- Be aware of other activities in the vicinity of your flight path that could cause potential conflict.
- Carefully plan your flight path prior to launch.
- Abide by any and all established AMA National Model Aircraft Safety Code.





© 2008 Horizon Hobby, Inc.  
4105 Fieldstone Road  
Champaign, Illinois 61822  
(877) 504-0233  
[horizonhobby.com](http://horizonhobby.com)  
[E-fliteRC.com](http://E-fliteRC.com)