

F-86 Sabre 15 DF

Assembly Manual



Specifications

| | |
|---------------------|------------------------|
| Wingspan: | 33.8 in (860mm) |
| Length: | 35.4 in (900mm) |
| Wing Area: | 256 sq in (16.5 sq dm) |
| Weight w/o Battery: | 40-42 oz (1135-1190 g) |
| Weight w/Battery: | 53-55 oz (1500-1560 g) |

Pilot not included (PKZ7003)

Table of Contents

| | |
|---|----|
| Introduction | 2 |
| Important Information Regarding Warranty Information | 2 |
| Using the Manual..... | 2 |
| Contents of Kit/Parts Layout..... | 2 |
| Recommended Radio Equipment | 3 |
| Required Brushless Ducted Fan Setup..... | 3 |
| Required Tools and Adhesives | 3 |
| Optional Accessories..... | 3 |
| Warnings | 3 |
| Aileron Servo Installation..... | 4 |
| Aileron Linkage Installation | 6 |
| Mounting the Main Wing Panels | 9 |
| Stabilizer Installation | 12 |
| Elevator Installation | 15 |
| Rudder Installation | 16 |
| Elevator Servo and Linkage Installation..... | 18 |
| Rudder Servo and Linkage Installation | 22 |
| Landing Gear Installation..... | 24 |
| Steering Servo and Linkage Installation..... | 26 |
| Speed Control and Receiver Installation | 27 |
| Intake Tube Installation..... | 29 |
| Fan Installation..... | 30 |
| Exhaust Tube Installation | 32 |
| Securing the Intake Tube | 34 |
| Canopy Assembly | 35 |
| Motor Battery Installation | 35 |
| Decal Placement..... | 36 |
| Center of Gravity | 36 |
| Control Throws..... | 37 |
| Preflight..... | 38 |
| Flying Your F-86 Sabre 15 DF..... | 38 |
| Range Test Your Radio | 38 |
| Safety Do's and Don'ts for Pilots..... | 39 |
| Daily Flight Checks..... | 39 |
| Warranty and Repair Policy..... | 39 |
| Warranty Services..... | 40 |
| Compliance Information for the European Union | 41 |
| 2010 Official Academy of Model Aeronautics Safety Code | 41 |

Introduction

This performance model was designed around E-flite's Delta-V 15 (69mm) fan unit and matched 15 DF 3200Kv brushless motor. Pilots can use a 4-cell Li-Po battery pack for great performance. The built-in fan mounts make installing the fan easy—just drop in the fan unit and tighten four screws. The removable magnetic front hatch also allows easy access to the radio equipment and battery. The entire trim scheme is pre-painted, pre-trimmed; the wings are covered in UltraCote®. Just add your favorite nose art decals and enjoy.

Important Information Regarding Warranty Information

Please read our Warranty and Liability Limitations section on Page 39 before building this product. If you as the Purchaser or user are not prepared to accept the liability associated with the use of this Product, you are advised to return this Product immediately in new and unused condition to the place of purchase.

Using the Manual

This manual is divided into sections to help make assembly easier to understand, and to provide breaks between each major section. In addition, check boxes have been placed next to each step to keep track of its completion. Steps with a single circle (○) are performed once, while steps with two circles (○○) indicate the step will require repeating, such as for a right or left wing panel, two servos, etc.

Remember to take your time and follow the directions.

Contents of Kit/Parts Layout

Replacement Parts

| | |
|---------|--|
| EFL8101 | Fuselage with Upper and Lower Hatch |
| EFL8102 | Canopy Hatch |
| EFL8103 | Left Wing Panel with Hinged Aileron |
| EFL8104 | Right Wing Panel with Hinged Aileron |
| EFL8105 | Horizontal Stabilizer with Elevator (left and right) |
| EFL8106 | Pushrods and Carbon Wing Tubes |
| EFL8107 | Plastic Accessories |
| EFL8108 | Landing Gear and Wheels with Hardware |
| EFL8109 | Control Hardware |
| EFL8110 | Intake and Thrust Tube |
| EFL8111 | Consumer Decal Sheet |



Recommended Radio Equipment

You will need a minimum 4-channel transmitter, receiver and five servos. You can choose to purchase a complete radio system. If you are using an existing transmitter, just purchase the other required equipment separately. We recommend the crystal-free, interference-free Spektrum™ DX6i 2.4GHz DSM® 6-channel system. If using your own transmitter, we recommend the following radio equipment.

If you own the Spektrum DX6i radio, or you are using a different DSM2 radio, just add the AR6200 DSM2™ 6-channel receiver, four E-flite S75 Sub-Micro servos and one JR SPORT™ MC35 servo

Complete Radio System

SPM6600 DX6i DSM2 6CH system

Or Purchase Separately

SPMAR6200 AR6200 DSM2 6-Channel Full-Range Receiver (for DX6i or DX7)
EFLRS75 7.5-Gram Sub-Micro S75 Servo (4)
JSP20030 MC35 Micro Servo

And

EFLREX9L 9-inch Extension, Lightweight (2)

Note: A Y-harness can be used for the for nose gear steering if a computer radio with mixing is not being used.

EFLRYH3 3-inch Y-Harness, Lightweight

Required Brushless Ducted Fan Setup

EFLM3215DF 15 DF Brushless Motor, 3200Kv
EFLDF15 Delta-V 15 (69mm) Ducted Fan Unit
EFLA1060 60-Amp Pro Switch-Mode BEC Brushless ESC
EFLB32004S30 3200mAh 4S 14.8V 30C Li-Po, 13AWG EC3

The Spektrum trademark is used with permission of Bachmann Industries, Inc.

Required Tools and Adhesives

Tools & Equipment

| | |
|---|------------------------------|
| Epoxy brushes | Felt-tipped pen |
| Hobby scissors | Hobby knife (#11 blade) |
| Low-tack tape | Hex wrench: 1.5mm |
| Mixing cups | Sanding bar |
| Mixing sticks | Needle-nose pliers |
| Paper towels | Pencil |
| Petroleum jelly | Phillips screwdriver: #0, #1 |
| Pin vise | Rubbing alcohol |
| Ruler | Scissors |
| Side cutters | Square |
| String/dental floss | Toothpicks |
| T-pins | Waxed paper |
| Sandpaper | |
| Drill bit: 1/16-inch (1.5mm), 5/64-inch (2mm) | |

Adhesives

| | |
|------------|---------------------------|
| Threadlock | 6-Minute Epoxy (HAN8000) |
| Thin CA | 12-Minute Epoxy (HAN8001) |
| Medium CA | |

Optional Accessories

| | |
|-----------|--|
| PKZ7003 | Pilot: Habu |
| EFLA110 | Power Meter |
| EFLC505 | Intelligent 1- to 5-Cell Balancing Charger |
| EFLAEC312 | Charge Lead with 12-inch wire and Jacks, 16AWG |

Warnings

Read and follow all instructions and safety precautions before use. Improper use can result in fire, serious injury and damage to property.

COMPONENTS

Use only with compatible components. Should any compatibility questions exist please refer to the product instructions, the component instructions or contact Horizon Hobby, Inc.

FLIGHT

Fly only in open areas to ensure safety. It is recommended flying be done at AMA (Academy of Model Aeronautics) approved flying sites.

PROPELLER

Keep loose items that can get entangled in the propeller away from the prop, including loose clothing, or other objects such as pencils and screwdrivers. Especially keep your hands away from the propeller as injury can occur.

BATTERIES

Notes on Lithium Polymer Batteries

Lithium Polymer batteries are significantly more volatile than alkaline or Ni-Cd/Ni-MH batteries used in RC applications. Always follow the manufacturer's instructions when using and disposing of any batteries. Mishandling of Li-Po batteries can result in fire and explosion causing serious injury and damage.

SMALL PARTS

This kit includes small parts and should not be left unattended near children as choking and serious injury could result.

SAFETY PRECAUTIONS

This is a sophisticated hobby Product and not a toy. It must be operated with caution and common sense and requires some basic mechanical ability. Failure to operate this Product in a safe and responsible manner could result in injury or damage to the Product or other property. This Product is not intended for use by children without direct adult supervision. The Product manual contains instructions for safety, operation and maintenance. It is essential to read and follow all the instructions and warnings in the manual, prior to assembly, setup or use, in order to operate correctly and avoid damage or injury.

E-tips

During the course of building your F-86 Sabre we suggest you use a soft base for the building surface. Such things as a foam stand, large piece of bedding foam or a thick bath towel will work well and help protect the model from damage during assembly.

Aileron Servo Installation

Required Parts

| | |
|----------------------------------|------------------|
| Left wing panel | Right wing panel |
| Transmitter | Receiver |
| Servo (2) | |
| 2.5 x 12mm sheet metal screw (4) | |
| 9-inch (228mm) extension (2) | |
| Aileron servo mount (2) | |
| Servo mounting strap (2) | |

Required Tools and Adhesives

| | |
|-----------------------|----------------------------|
| Medium grit sandpaper | |
| 6-minute epoxy | Phillips screwdriver: #1 |
| Dental floss/string | Hobby knife with #11 blade |
| Side cutter | Ruler |
| Pen | Mixing cups |
| Mixing sticks | Paper towels |

E-tips

The wood servo cover will not be used when installing the recommended E-flite S75 servo for the ailerons. If you install a smaller servo, you may choose to use the plywood cover rather than the molded plastic cover.

- ○ 1. Remove the wood servo cover from the wing. Set the cover aside.



- ○ 2. Relocate the string from the aileron opening so it is near one of the corners. This allows full access to the opening and prevents accidentally gluing the string into the wing.



E-tips

DO NOT remove the string from the wing. The string will be used to pull the aileron servo lead through the wing later in this section.

- ○ 3. Measure and mark the opening for the aileron servo 3/4-inch (19mm) from the edge closest to the wing root as shown. The edge of the aileron servo mount will align with these marks when it is installed. Center the mount fore/aft in the opening for the aileron servo.

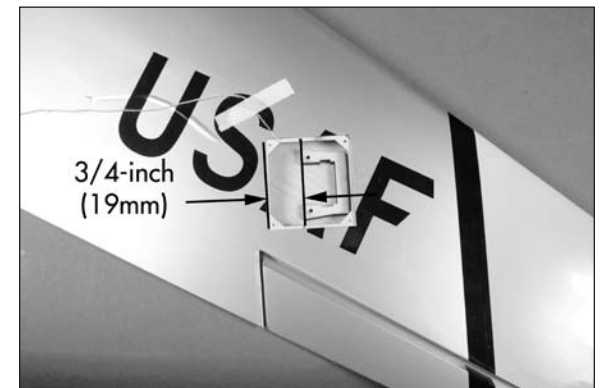

- 4. Lightly sand the aileron servo mount using medium grit sandpaper. This allows the glue to penetrate into the mount and provides a better bond between the mount and wing.

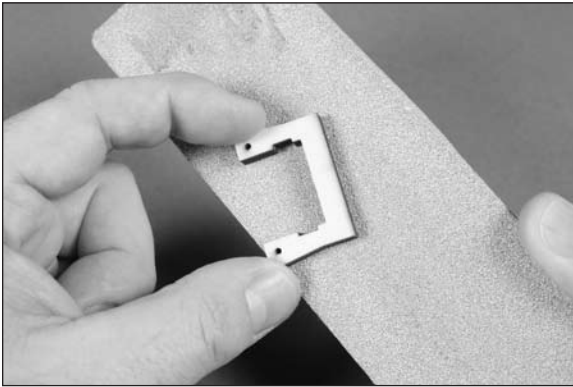

- 5. Mix a small amount of 6-minute epoxy and brush it onto the side of the aileron servo mount that was sanded in the previous step. Position the mount in the wing as shown in Step 3 and allow the epoxy to fully cure before proceeding.



Etips

While waiting for the epoxy to dry on one wing panel, you can repeat the previous steps to glue the remaining servo mount into the opposite wing panel.

- 6. Use a hobby knife with a #11 blade to enlarge the hole in the servo arm indicated in the photo. Only open the hole in the servo arm enough for the aileron linkage to fit in. Making it larger will only create a poor fit between the linkage and servo arm and make it difficult to trim your aircraft.

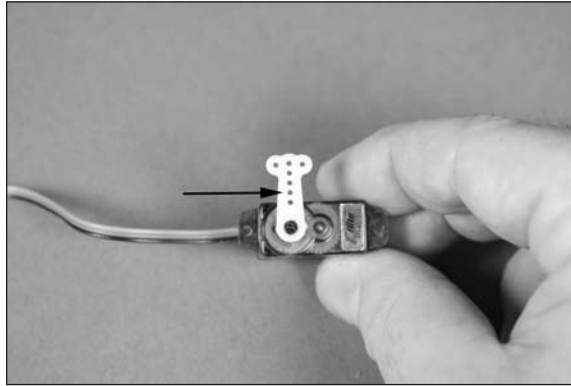

- 7. Use a hobby knife and #11 blade or side cutters to remove the excess servo arm so it does not interfere with the servo cover when it is installed.

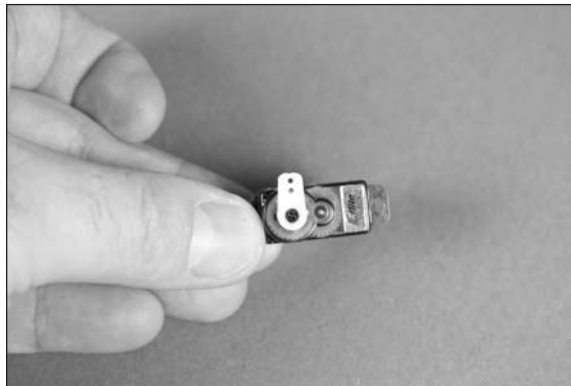

- 8. Prepare a second aileron servo as shown in Steps 6 and 7. Note the servos will be a mirror image of each other. Plug the aileron servos into the receiver and use the transmitter to center the servos. Also check that they are operating correctly at this time.

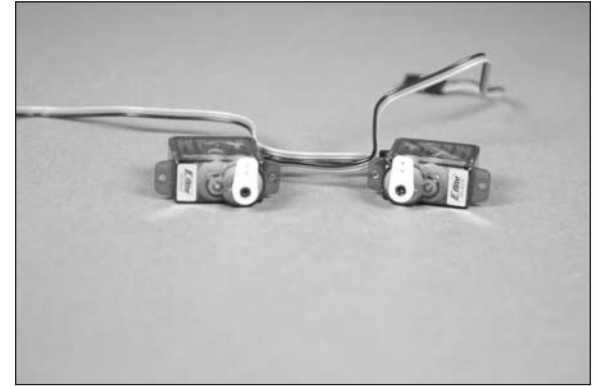

- 9. Position the aileron servo in the servo mount as shown in the image with the horn facing the front of the wing.



- ○ 10. Use a #1 Phillips screwdriver and two 2.5mm x 12 sheet metal screws to secure the servo in the servo mount using the servo mounting strap. Install one screw and only turn it one or two turns, then install the second screw. Tighten the strap with even pressure at both the front and back of the servo.



E-tips

Use care when installing the servo mounting strap. Over-tightening the strap could stress the wing sheeting and even push the servo through the top of the wing.

- ○ 11. Use string or dental floss to secure a 9-inch (228mm) servo extension to the lead from the aileron servo.



- ○ 12. Tie the string around the end of the servo lead as shown.

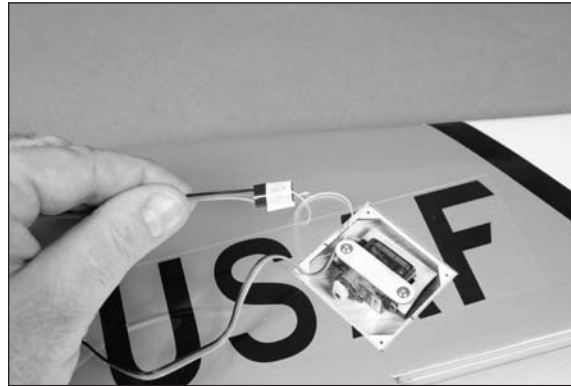

- ○ 13. Carefully pull the aileron servo lead through the wing using the string tied to it in the previous step.

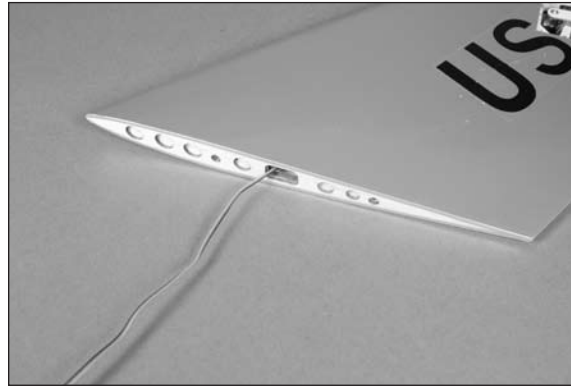

- 14. Repeat Steps 1 through 13 to install the remaining aileron servo.

Aileron Linkage Installation

Required Parts

| | |
|--|------------|
| Transmitter | Receiver |
| Aileron pushrod keeper (2) | |
| Aileron pushrod wire, 2 9/16-inch (65mm) (2) | |
| Servo cover (2) | |
| Aileron control horn (2) | Clear tape |

Required Tools and Adhesives

| | |
|---|----------------------------|
| Side cutters | Medium CA |
| Pin vise | Low-tack tape |
| Felt-tipped pen | Hobby knife with #11 blade |
| Needle-nose pliers | Hobby scissors |
| Drill bit: 1/16-inch (1.5mm), 5/64-inch (2mm) | |

- ○ 1. Use a small piece of low-tack tape to keep the aileron centered with the trailing edge of the wing. This will make the installation of the linkage much easier.



- 2. Locate the two holes for the aileron control horn in the aileron. The holes should be located directly behind the servo arm. Use a hobby knife with a #11 blade or pin vise with a 1/16-inch (1.5mm) drill bit to remove the covering for the aileron control horn. Use care not to accidentally make holes through to the top of the aileron.

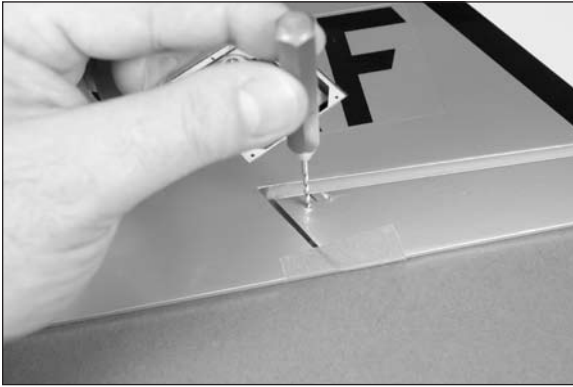

- 3. Use side cutters to trim the pins on the control horn to a length of 1/8-inch (3mm) so they don't extend through the top of the aileron.

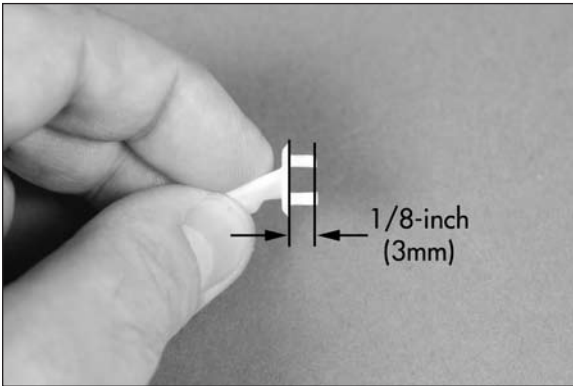

- 4. Insert the pins of the control horn into the holes in the aileron. Use a felt-tipped pen to trace the outline of the control horn onto the aileron.

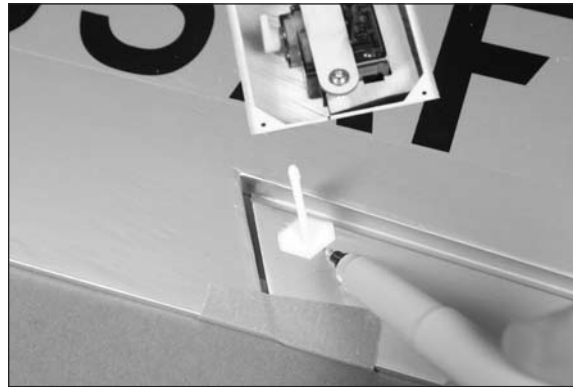

- 5. Remove the control horn. Use a hobby knife with a #11 blade to trim the covering 1/32-inch (1mm) inside the lines drawn. Don't cut into the underlying wood as you could possibly weaken the structure.

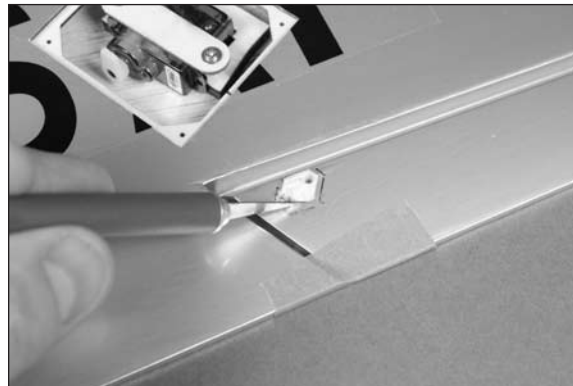

- 6. Use medium CA to glue the control horn to the aileron. Allow the CA to cure before proceeding to the next step.



- 7. Connect the Z-bend of the 2°/16-inch (65mm) aileron pushrod wire to the hole in the servo horn as shown.



- 8. Slide the pushrod connector onto the pushrod wire at this time. The connector can't be installed after the wire has been bent to fit into the control horn so it must be positioned at this time.

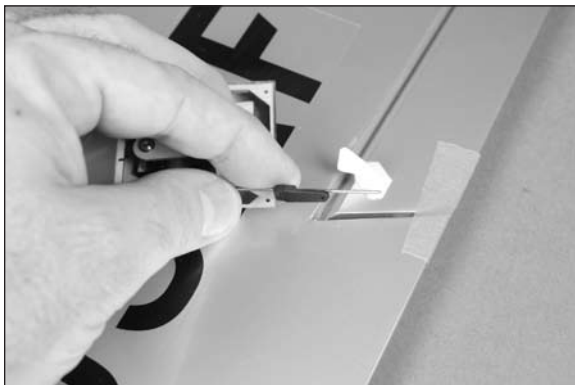

- 9. With the aileron servo centered and the radio system on, use a felt-tipped pen to mark the wire where it crosses the hole of the control horn as shown.



- 10. Use pliers to make a 90-degree bend in the pushrod wire. The bend must be angled to fit into the control horn.



- 11. Use side cutters to trim the wire 1/4-inch (6mm) from the bend as shown.

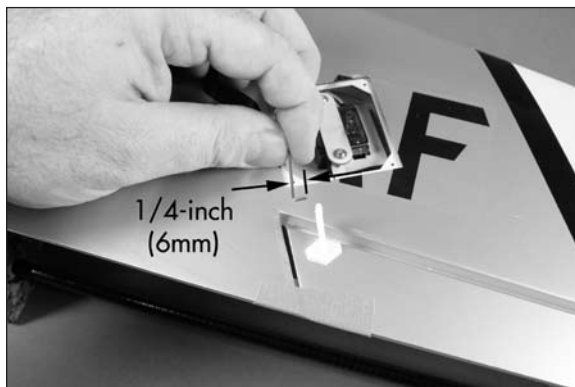

- 12. Insert the pushrod wire into the hole of the control horn that is two holes up from the control surface as shown.

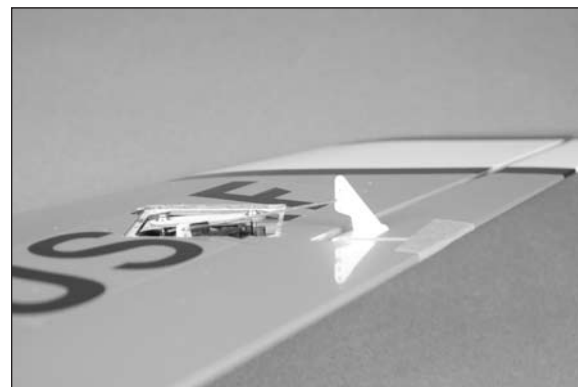

- 13. Use pliers to open the pushrod keeper just enough to slip it over the bend of the pushrod wire so it secures the pushrod wire to the control horn. Don't open the connector too far as it could possibly break the connector.

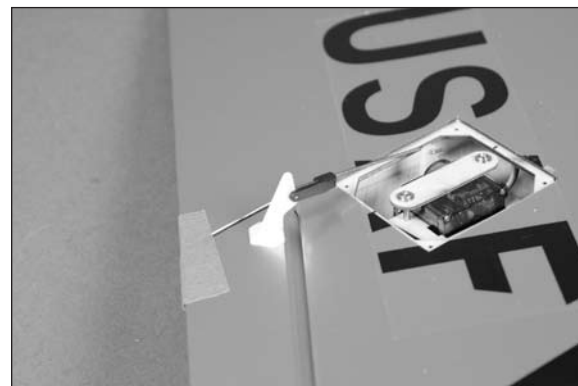

- 14. Use a hobby knife and #11 blade or hobby scissors to trim the aileron servo cover. Lines have been embossed on the cover to be used as a guide. Make sure the opening for the linkage is angled slightly so the linkage doesn't bind on the cover.

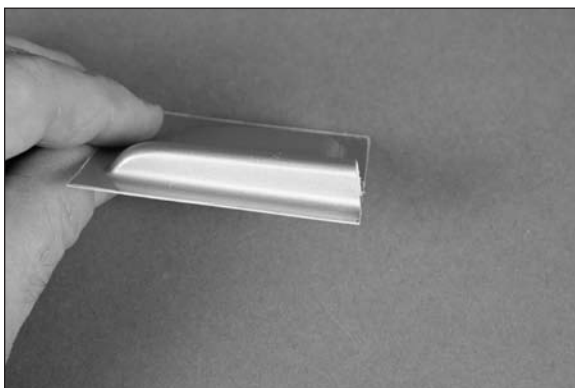
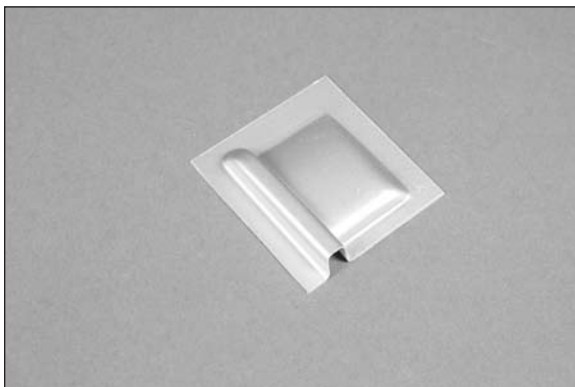

- 15. Use the tape provided with the model to attach the cover to the wing. Make sure the aileron servo can operate without having the linkage binding on the cover.



- 16. Apply the decal to the servo cover. Take your time to fit the decal to the contours of the cover.



- 17. Repeat Steps 1 through 16 to install the remaining aileron linkage and servo cover.

E-tips

Cut the portions of the letters from the decal sheet to apply to the cover to complete the form of the covered letters.

Mounting the Main Wing Panels

Required Parts

Left wing assembly Right wing assembly
Carbon wing rod, 9-inch (230mm)
Carbon wing rod, 13-inch (330mm)
Fuselage assembly

Required Tools and Adhesives

12-minute epoxy Mixing cup
Mixing stick Epoxy brush
Paper towel Rubbing alcohol
Low-tack tape Sandpaper
Sanding Bar

- 1. Remove the shipping tape that holds the canopy to the fuselage.



- 2. Carefully lift the canopy hatch from the fuselage. The canopy is held in position by magnets and alignment pegs at the rear and a peg at the front.



- 3. Slide the short and long wing rods into one of the wing panels. The longer wing rod will be inserted near the trailing edge of the wing, and the shorter rod toward the leading edge of the wing.

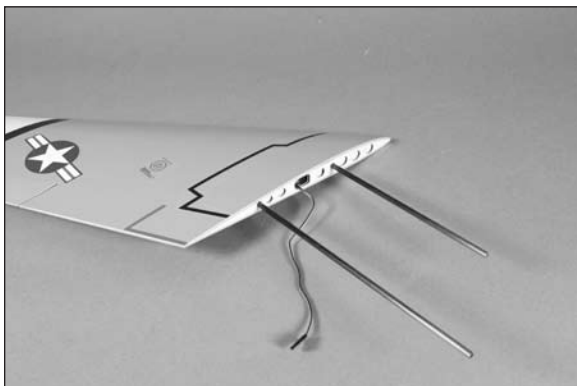
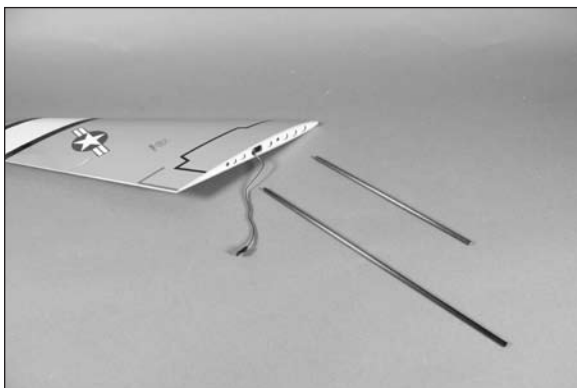

- 4. Slide the wing tubes into the fuselage. Make sure to guide the aileron servo extension into the fuselage so the wing can fit tight against the fuselage.



- 5. Look at the fit of the wing to the fuselage on both the top and bottom. You will need to use sandpaper to remove the paint from the fuselage where the wing fits or the epoxy won't hold the wing securely to the fuselage. You also don't want to sand too much and ruin the paint on the fuselage.



Etips

You can use low-tack tape to make an outline about a 1/16-inch (1.5mm) inside the wing outline on the fuselage to prevent it from scratching the paint.

- 6. Remove the wing from the fuselage. Use medium grit sandpaper to remove the paint from the fuselage where the wing fits.



- 7. Repeat Steps 1 through 6 to prepare the opposite side of the fuselage for the wing.



- 8. Apply a thin layer of 15-minute epoxy to the fuselage where it was sanded previously.



- 9. Apply a thin layer of 15-minute epoxy to the short and long wing rods before you insert them into the wing.

- 10. Apply a thin coat of 15-minute epoxy on the end of the wing that will butt against the fuselage.

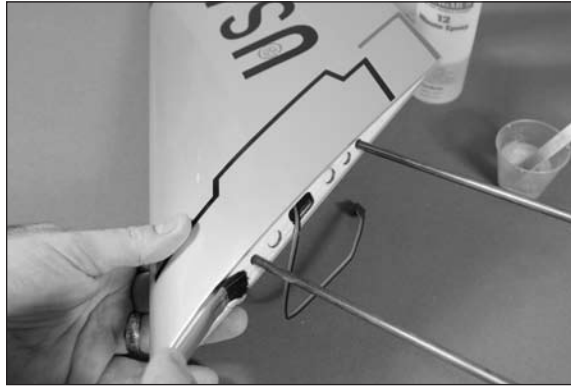

- 11. Slide the wing into position against the fuselage. Use low-tack tape to keep the wing tight against the fuselage until the epoxy fully cures.

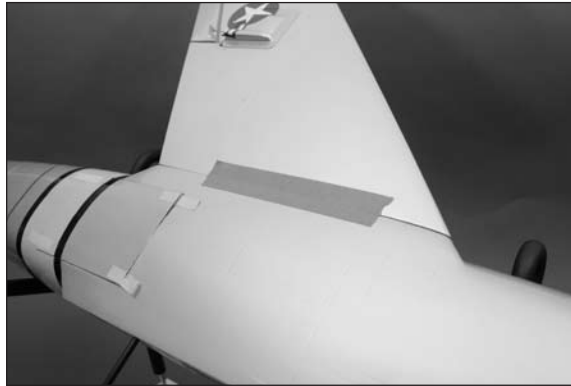

- 12. Repeat Steps 8 through 11 to install the remaining wing panel to the fuselage.

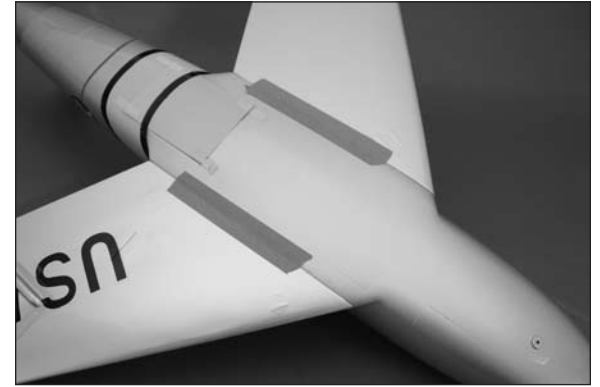

- 13. Before the epoxy cures, use a paper towel and rubbing alcohol to remove any excess epoxy that may have oozed out from the joint between the wing and fuselage.



Stabilizer Installation

Required Parts

Stabilizer jig center Stabilizer jig side (2)
Right stabilizer Left stabilizer
Airframe assembly

Required Tools and Adhesives

Medium CA Square
6-minute epoxy Mixing cup
Mixing stick Epoxy brush
Paper towel Rubbing alcohol
Low-tack tape Waxed paper
Ruler Felt-tipped pen
Hobby knife with #11 blade

- 1. Use a square and medium CA to glue the stabilizer jig center to the stabilizer jig side. The square will keep the center perpendicular to the side and result in a straight jig. Not doing so may result in the jig being crooked and could produce the wrong angle when gluing the stabilizer halves together.

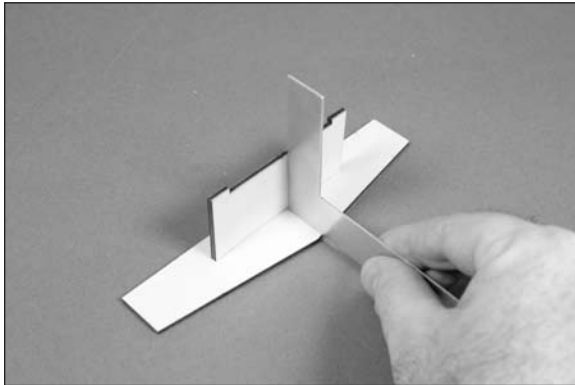

- 2. Use a square and medium CA to glue the stabilizer jig side to the structure assembled in Step 1. Using a square will keep the side perpendicular to the stabilizer jig center. Not doing so may result in the jig being crooked and could produce the wrong angle when gluing the stabilizer halves together.

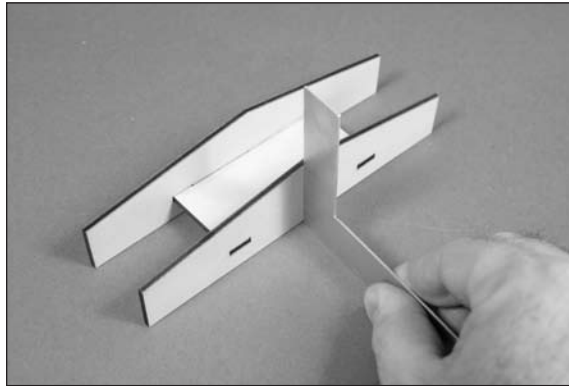

- 3. Separate the elevator from the stabilizer. Set the elevator and hinges aside at this time.

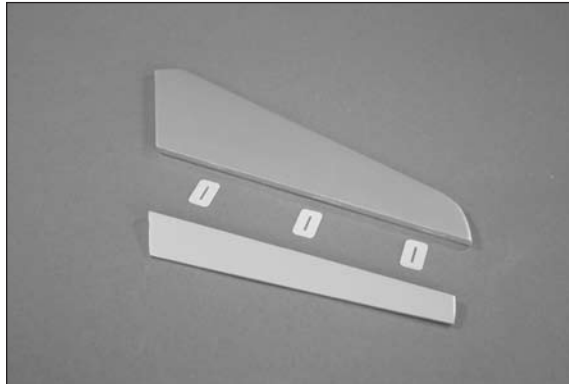

- 4. Use a hobby knife and a #11 blade to remove the covering from the end of both the left and right stabilizers.

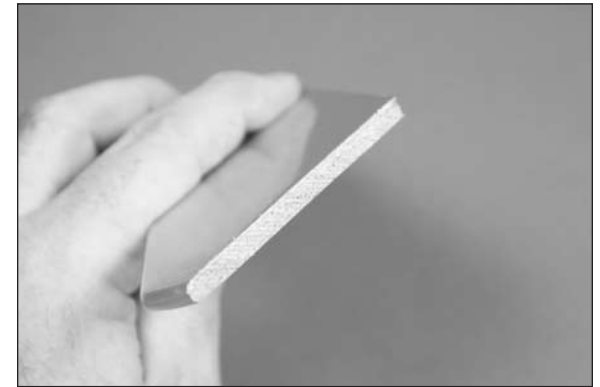

- 5. The stabilizer halves have been prepared at the factory with an angle so they fit tightly together when joined. If the fit is incorrect, the two halves will not fit tightly together.

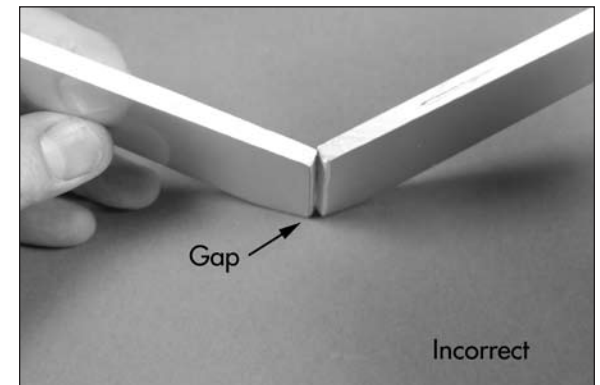
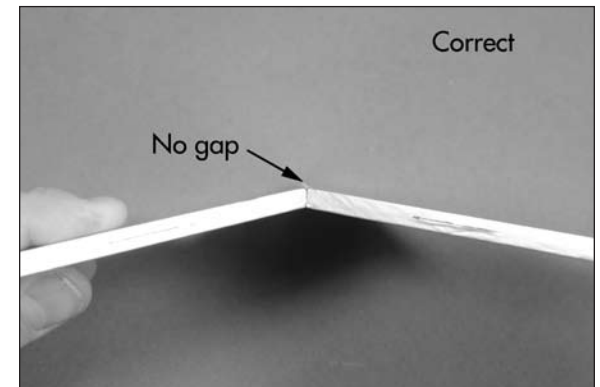

- 6. Place a piece of clear plastic or waxed paper over the stabilizer jig to prevent gluing the stabilizer directly to the jig.



- 7. Position the two stabilizer halves together (remember the angle) and align the front edges of the stabilizer halves. Use a small piece of low-tack tape to act as a hinge and keep the halves aligned. Position the stabilizer assembly on the jig to make sure the halves can rest against the jig without forcing them. If not, you will need to make a small gap between the two halves before taping them together.



- 8. Mix a small amount of 6-minute epoxy and use an epoxy brush to apply a thin layer of epoxy on the edges of each stabilizer half.



- 9. Position the stabilizer on the jig and either hold it or use weights to keep the halves tight against the jig until the epoxy fully cures.



- 10. Slide the stabilizer into the slot in the fuselage. Make sure that they are installed in the fuselage with dihedral as shown in Step 12. Measure the distance from the fuselage to the tip of the stabilizer on both sides of the fuselage. Both measurements must be equal. If they are not, reposition the stabilizer and re-measure until both measurements are equal on both sides of the fuselage.

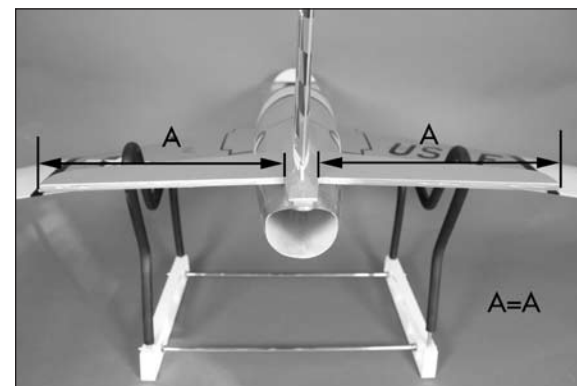

- 11. Measure the distance from the wing tip to the stabilizer tip on both the right and left of the aircraft. Both measurements must be equal. If not, readjust the stabilizer and re-measure until the measurement is the same on both the left and right of the aircraft.

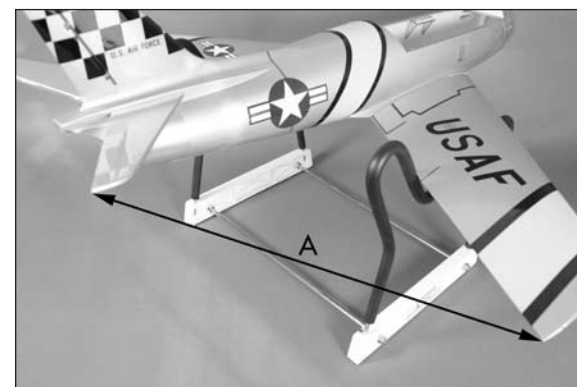

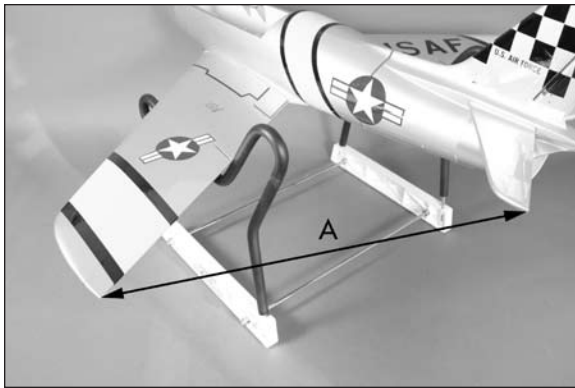

- 12. Step back about 4–5 feet (1.2–1.5 meters) and view the fuselage from the rear. Check that the stabilizer is in alignment with the wing by checking the stabilizer tips against the wing. Both stabilizer tips should align with the wing trailing edge. Adjust the position of the stabilizer if necessary for correct stabilizer alignment.

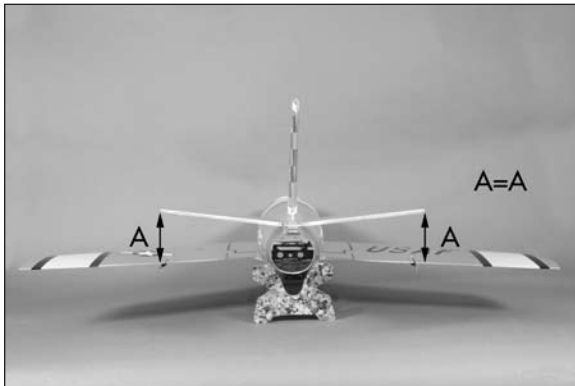

- 13. Use a felt-tipped pen to trace the outline of the fuselage onto the top, bottom, left and right of the stabilizer.

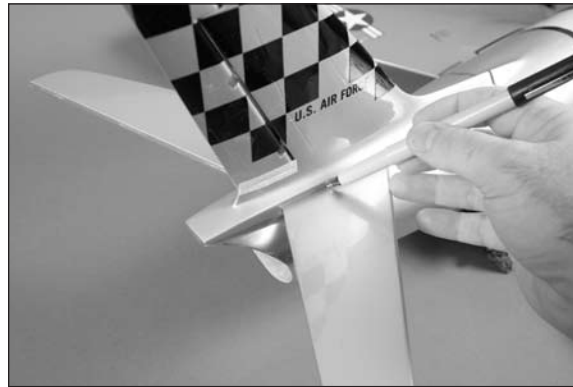

- 14. Remove the stabilizer from the fuselage. Carefully use a hobby knife to remove the covering 1/16-inch (1.5mm) from inside the lines. Use light pressure with a new #11 blade to avoid cutting into the underlying wood. You will need to trim the covering from the top and bottom of the stabilizer at this time.

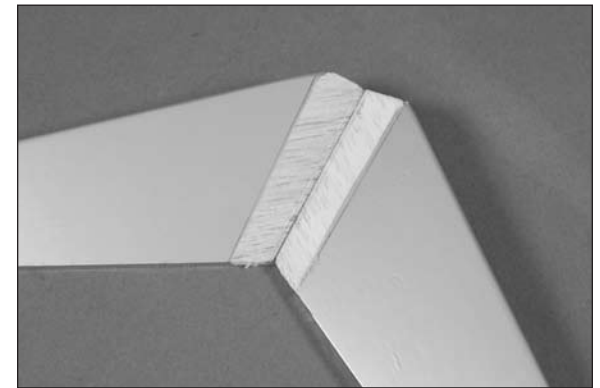
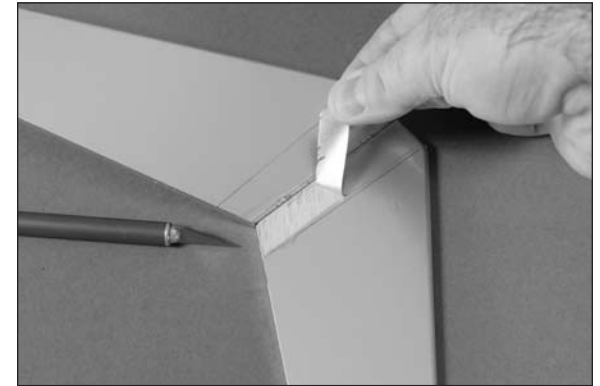

E-tips

Other options other than a hobby knife are to use a hot knife (with a new blade) or a soldering iron for cutting the covering. These will melt the covering and lower the chances of cutting into the wood structure of the stabilizer.

- 15. Reinstall the stabilizer and check all of the alignments from steps 10–12. Use medium CA to glue the stabilizer to the fuselage. Apply a bead of CA to the joint inside the fuselage, both right and left. Wick thin CA on the top of the stabilizer/fuselage joint by holding the nose down. Use care not to let the CA wick out on the outside of the fuselage or stabilizer.



E-tips

Use a paper towel and rubbing alcohol to remove the lines from the stabilizer and fuselage before gluing the stabilizer in position.

Elevator Installation

Required Parts

Elevator (left and right)
CA hinge (6)

Required Tools and Adhesives

Thin CA T-pins

- 1. Place a T-pin in the center of three of the elevator hinges. This will help center them equally in the stabilizer and elevator when they are installed.

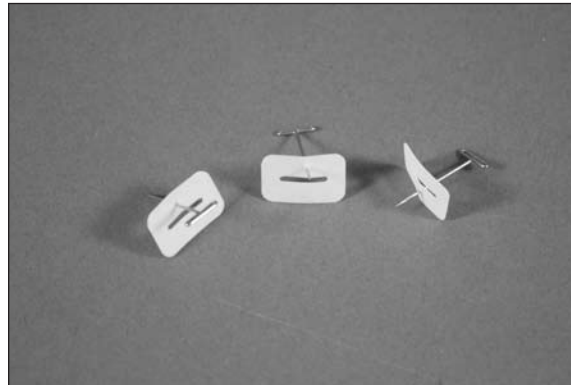

- 2. Slide the three hinges into the slots that have been pre-cut into the elevator.

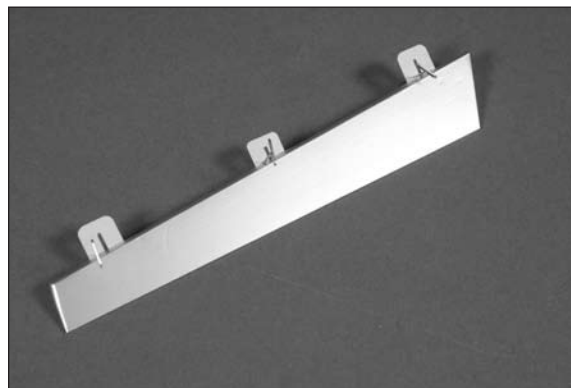

- 3. Place the elevator into position. The hinges will fit into the pre-cut slots in the stabilizer.



- 4. Position the elevator tight against the stabilizer. There should be just a slight gap between the elevator and the stabilizer. Check that the tips of the elevator and stabilizer align with each other.



- 5. Use thin CA to glue the three hinges. Apply CA to the top and bottom of each hinge, enough that it fully soaks into the hinge.



E-tips

DO NOT use CA accelerator on the hinges. The CA must be allowed to soak into the hinge to fully penetrate the hinge and surrounding wood. Accelerator will not allow the CA to soak into the hinge and will result in a poor bond between the hinge and surrounding wood.

- 6. Once the CA has fully cured, lightly pull on the elevator and stabilizer to make sure the hinges are secure. If not, apply additional CA to the hinges that are not secure.



- 7. Break in the elevator hinges by moving the elevator through its range of motion a few times. This will help in reducing the initial load on the servo and make the control surfaces easier to move initially.



- 8. Repeat Steps 1 through 7 to install the remaining elevator.

Rudder Installation

Required Parts

Fuselage assembly Pin hinge (3)

Required Tools and Adhesives

| | |
|-----------------|-----------------|
| Side cutter | 6-minute epoxy |
| Petroleum jelly | Toothpick |
| Paper towel | Rubbing alcohol |
| Mixing cup | Mixing stick |

- 1. Remove the shipping tape from the rudder and fuselage. Separate the rudder from the fuselage.



- 2. Apply a small amount of petroleum jelly to the knuckle of each of the rudder hinges. Use care not to get any petroleum jelly on the main parts of the hinge. Use side cutters to trim down the hinges that fit at the top and center of the rudder as shown.

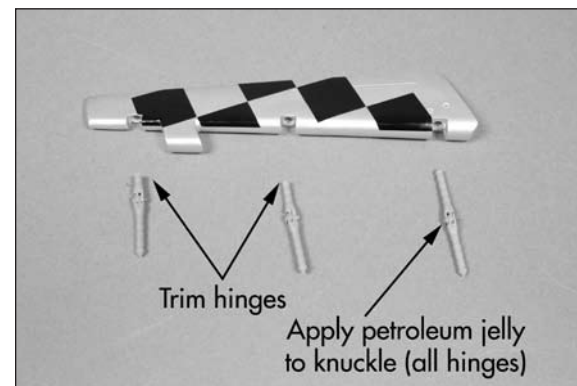

- 3. Test fit the hinges into the rudder. Each of the hinges will fit with the pin in the knuckle recessed in the hinge line as shown. The hinge line of the rudder is set back from the edge of the rudder as illustrated in the second photo.

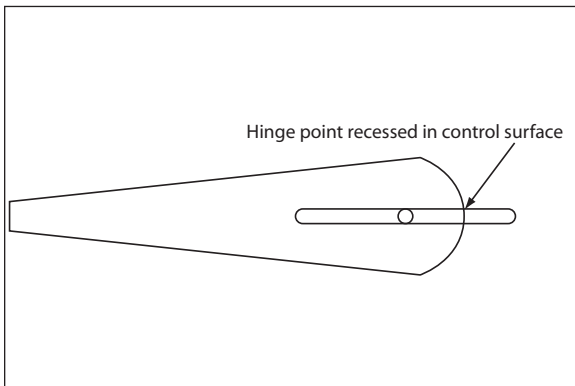
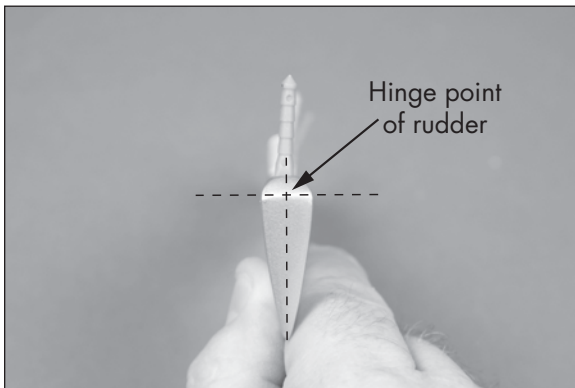
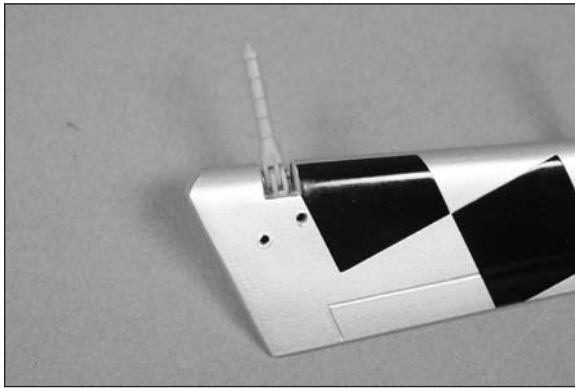

- 4. Check the fit of all three hinges. The top two may require adjustments if not trimmed properly in Step 2.

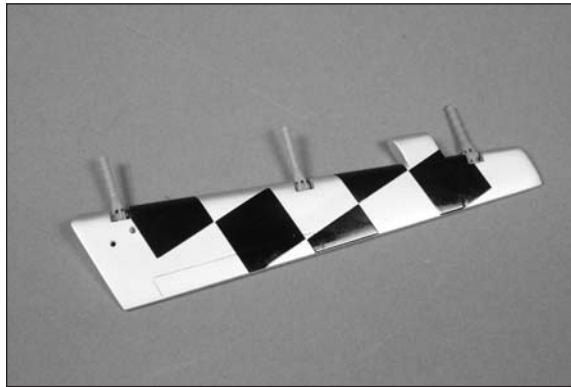

- 5. Mix a small amount of 6-minute epoxy. Apply the epoxy in each hinge pocket using a toothpick. Also apply a small amount of epoxy to each hinge where it fits into the pockets of the rudder.

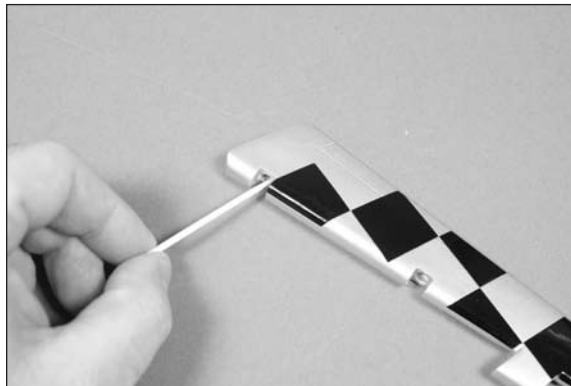

- 6. Insert the hinges in the rudder. Make sure each hinge can operate 90-degrees to the hinge line as shown before the epoxy begins to cure. Use rubbing alcohol and a paper towel to remove any excess epoxy from the hinges or rudder.

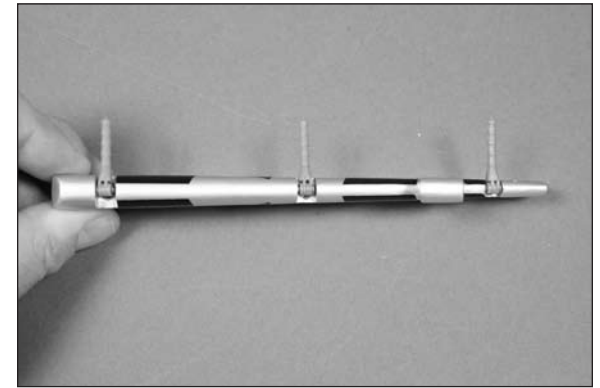

- 7. After the epoxy has fully cured, work each hinge through its range of motion check that the hinges have no epoxy in the knuckle.

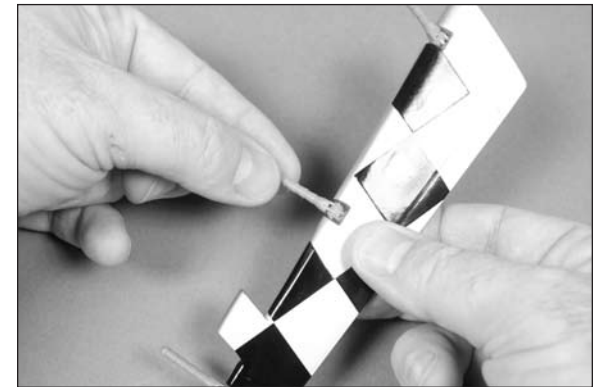

- 8. Check the fit of the rudder to the fin. Start by setting the hinges for about 45-degrees of throw. Insert the bottom hinge, then work upward inserting the middle then top hinge.



- 9. Once the fit has been checked, use 6-minute epoxy to glue the hinges in place. You will need to remove the rudder so you can use a toothpick to apply epoxy in the hinge pockets of the fuselage and to the hinges. Use rubbing alcohol and a paper towel to remove any excess epoxy from the hinges or rudder.

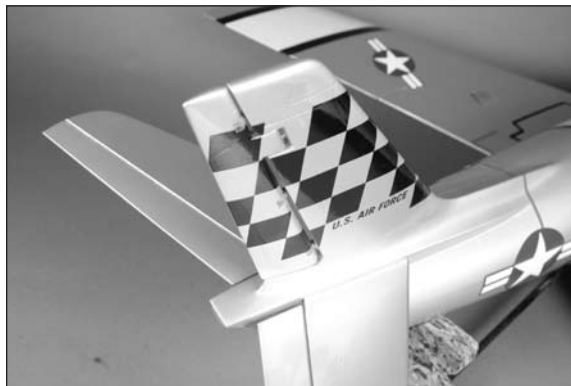

- 10. Once the epoxy has fully cured, work the rudder through its range of motion a number of times to make sure there is no epoxy in the knuckle.

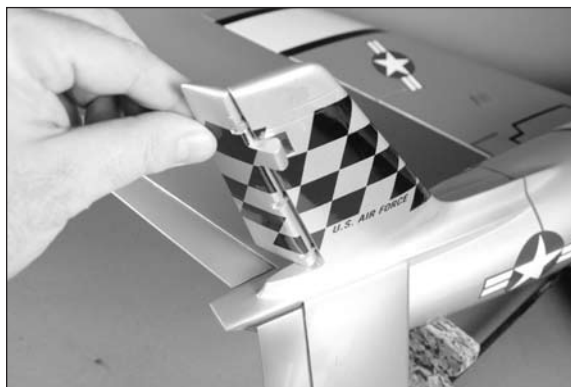

Elevator Servo and Linkage Installation

Required Parts

| | |
|---|---------------------------|
| Transmitter | Servo with hardware |
| Receiver | Assembled airframe |
| 2mm nut | 3mm x 4mm machine screw |
| 2mm washer | Elevator control horn (2) |
| Pushrod connector (large) | |
| Elevator pushrod keeper (2) | |
| Elevator pushrod wire, 19 ¹¹ / ₁₆ -inch (500mm) (2) | |

Required Tools and Adhesives

| | |
|--------------------|----------------------------|
| Side cutter | Hobby knife with #11 blade |
| Needle-nose pliers | Medium CA |
| Pin vise | Drill bit: 5/64-inch (2mm) |
| Threadlock | Felt-tipped pen |
| Thin CA | Phillips screwdriver: #1 |

- 1. Remove the screw holding the servo horn to the servo using a #1 Phillips screwdriver. Use the radio system to center the elevator servo so the shorter arm is positioned as shown. The pushrod connector will attach to this arm.

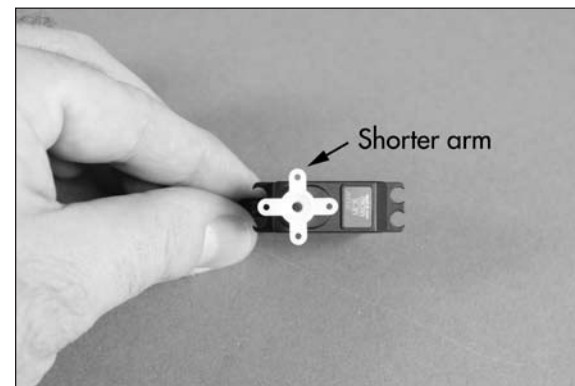

- 2. Remove the arm from the servo. Use side cutters to remove any arms that will not be used.

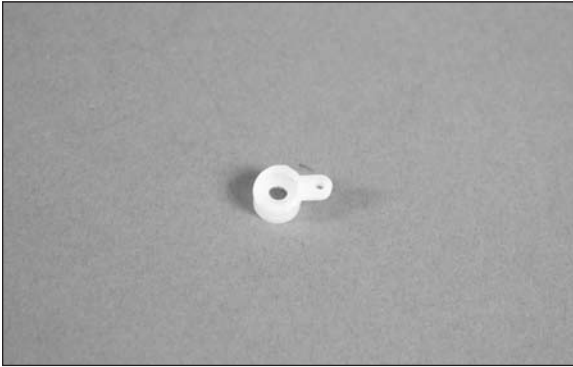

- 3. Use a pin vise and 5/64-inch (2mm) drill bit to enlarge the hole in the servo arm.

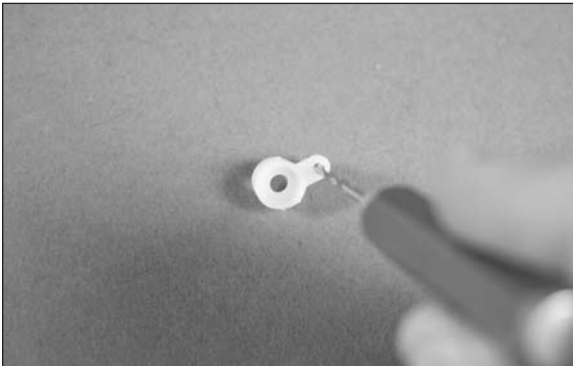

- 4. Insert the pushrod connector in the hole. It should move freely in the hole but not have excessive slop.

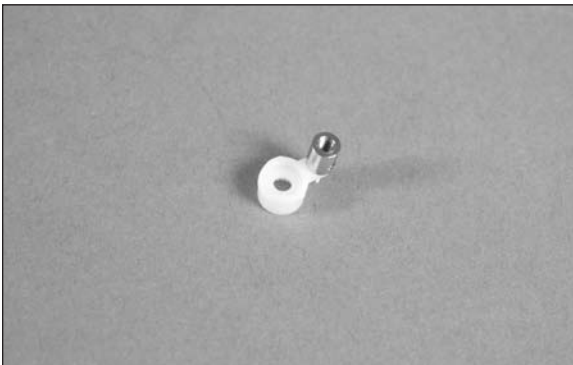

- 5. Slide a 2mm washer on the threaded end of the pushrod connector.



E-tips

Always use threadlock on metal-to-metal fasteners to prevent them from vibrating loose.

- 6. Install the 2mm nut on the pushrod connector. Don't over-tighten the nut causing the pushrod connector not to move. The nut should be just tight enough, so the connector can rotate freely. Make sure to secure this nut with threadlock or CA.



- 7. Install the servo horn on the servo using the screw provided with the servo and a #1 Phillips screwdriver.



- 8. Install the servo grommets and brass eyelets in the servo.



Etips

Do not enlarge the holes in the fuselage rails as some are used for the hatch alignment.

- 9. Use a #1 Phillips screwdriver to thread the servo mounting screw into the four holes for mounting the elevator servo.

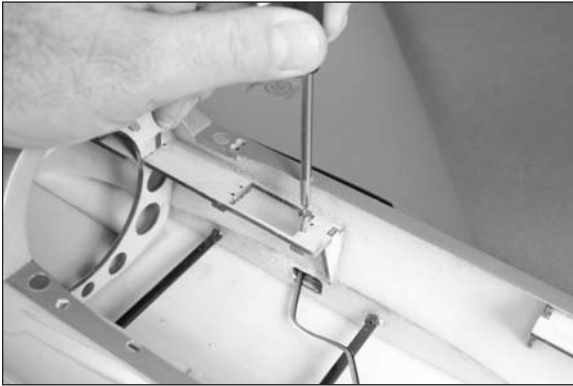

- 10. Place 2–3 drops of thin CA in each hole to harden the surrounding wood. This will harden the wood, making the screws more secure.



- 11. Secure the elevator servo in the fuselage using the screws provided with the servo and a #1 Phillips screwdriver.



- 12. Use a hobby knife and #11 blade to remove the covering to expose the holes to mount the elevator control horn. Use care not to poke through the hole to the top of the elevator.

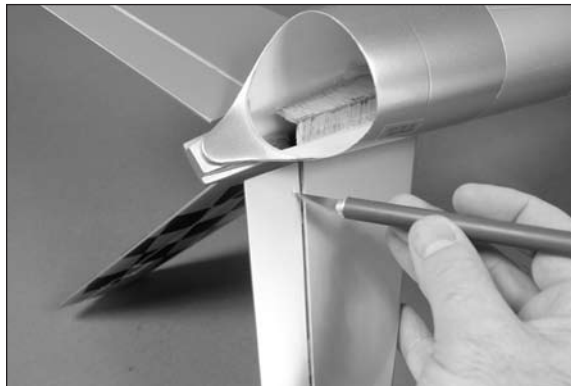

- 13. Use side cutters to trim the pins on the control horn to a length of 3/32-inch (2mm) so they don't extend through the top of the elevator.

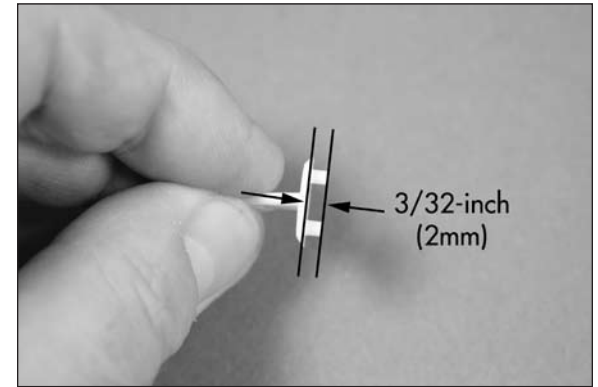

- 14. Position the horn on the elevator. Use a felt-tipped pen to trace the outline of the horn on the elevator.



- ○ 15. Use a hobby knife with a #11 blade to remove the covering 1/32-inch (1mm) inside the line drawn.

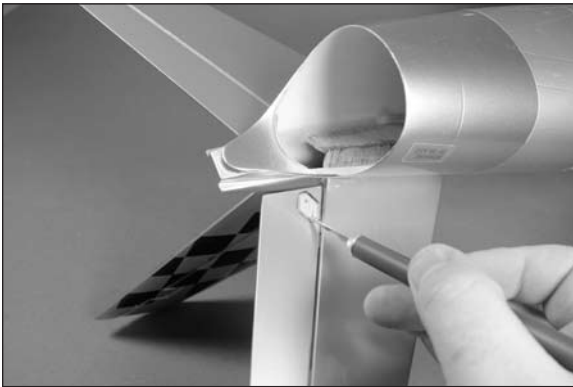

- ○ 16. Use medium CA to glue the control horn to the elevator. Allow the CA to cure before proceeding to the next step.

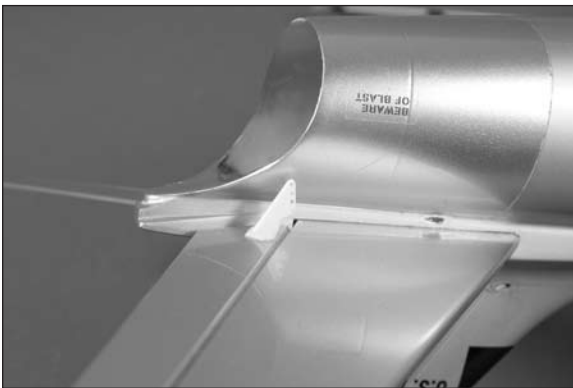

- ○ 17. Slide a pushrod connector on the 19¹¹/₁₆-inch (500mm) pushrod wire.

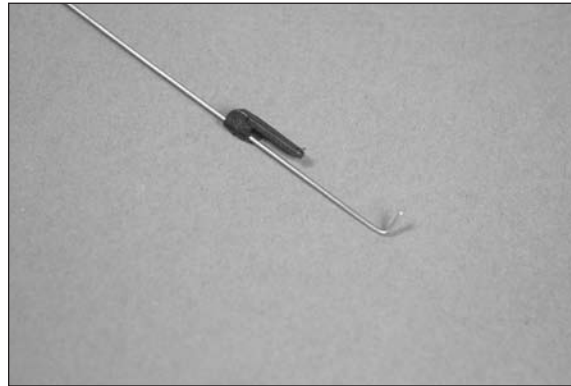

- ○ 18. Bend the pushrod wire as shown so it does not bind when operating the elevator. You will need to make a left and right pushrod.

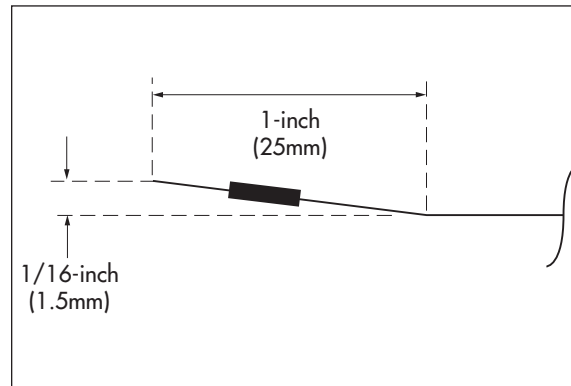

- ○ 19. Slide the pushrod wire into the pushrod tube in the fuselage closest to the elevator. Guide it into the connector on the servo at this time also.

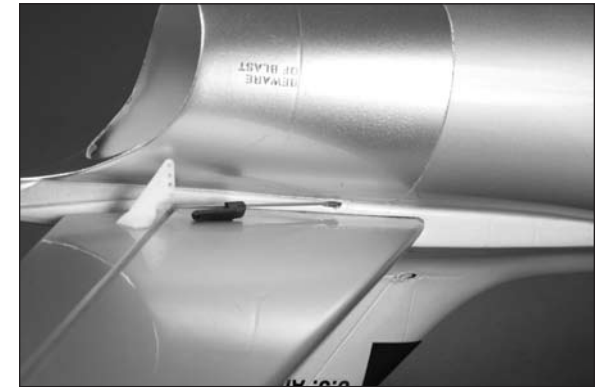

- ○ 20. Insert the pushrod wire into the hole of the control horn that is two away from the control surface as shown. Use pliers to open the pushrod keeper just enough to slip it over the bend of the pushrod wire so it secures the pushrod wire to the control horn. Don't open the connector too far as it could possibly break the connector.

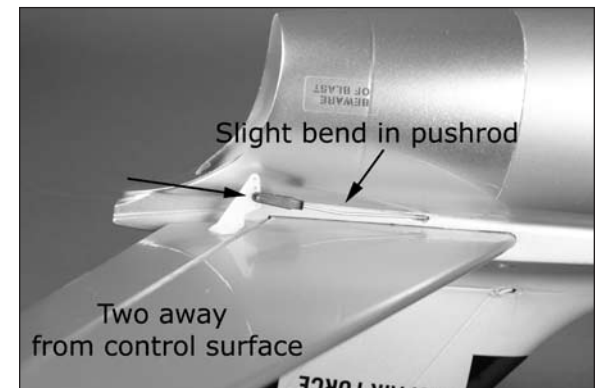

- 21. Repeat Steps 12 through 19 to install the remaining control horn and pushrod wire.

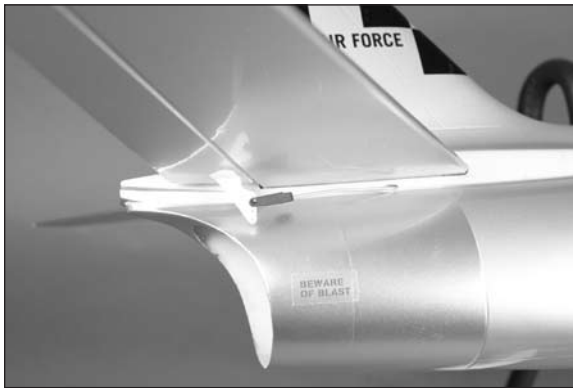

E-tips

Always use threadlock on metal-to-metal fasteners to prevent them from vibrating loose.

- 22. Center both elevator halves and the elevator servo. Use a 3mm x 4mm machine screw to secure the pushrod wires in the pushrod connector. Use a #1 Phillips screwdriver to tighten the screw. Use side cutters to trim the excess pushrod wire extending past the pushrod connector.



Rudder Servo and Linkage Installation

Required Parts

| | |
|---|---------------------|
| Transmitter | Servo with hardware |
| Receiver | Assembled airframe |
| Nylon pushrod backplate | |
| Micro pushrod connector | |
| 2mm x 4mm machine screw | |
| Pushrod connector (large) | |
| Rudder pushrod keeper | |
| Rudder pushrod wire, 19 ¹¹ / ₁₆ -inch (500mm) (2) | |

Required Tools and Adhesives

| | |
|--------------------------|------------------------------|
| Side cutter | Hobby knife with #11 blade |
| Medium CA | Threadlock |
| Pin vise | Drill bit: 1/16-inch (1.5mm) |
| 6-minute epoxy | Mixing cup |
| Mixing stick | Paper towels |
| Rubbing alcohol | Thin CA |
| Phillips screwdriver: #1 | |

- 1. Use 6-minute epoxy to glue the control horn to the rudder. Allow the epoxy to fully cure before proceeding.



- 2. Use the radio system to center the rudder servo. Note the direction of the servo arm in relationship to the servo.

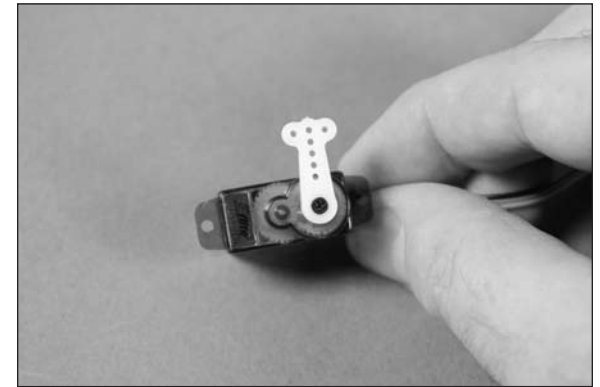

- 3. Use a pin vise and 1/16-inch (1.5mm) drill bit to enlarge the hole in the servo arm as shown.

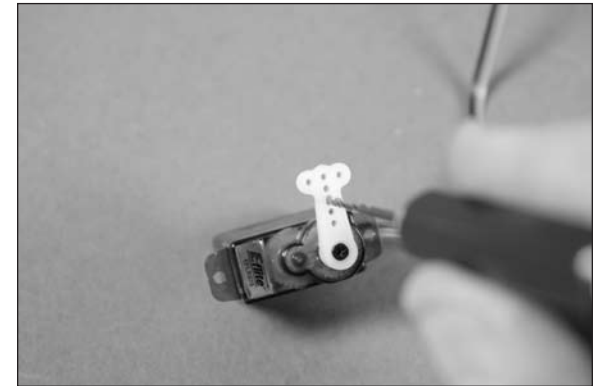

- 4. Use a hobby knife and #11 blade or side cutters to remove the excess servo arm so it does not interfere with the intake tube when it is installed.

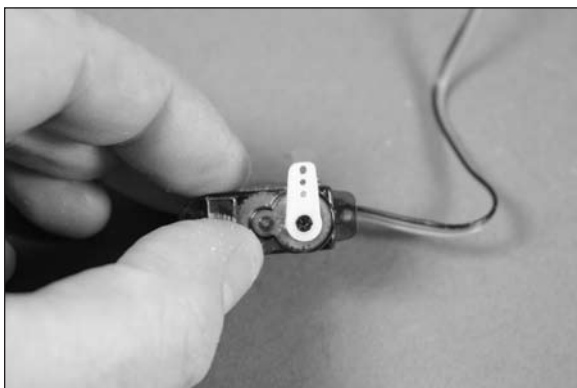

- 5. Insert the micro pushrod connector in the hole. It should move freely in the hole.



- 6. Install the nylon backplate on the pushrod connector to secure the connector to the servo horn.

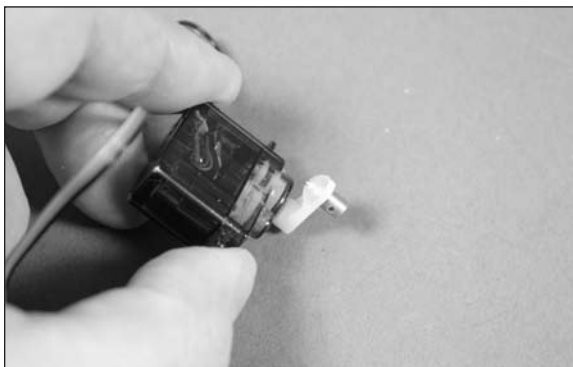

- 7. Use a #1 Phillips screwdriver to thread the servo mounting screw into the two holes for mounting the elevator servo.



- 8. Place 2-3 drops of thin CA in each hole to harden the surrounding wood. This will harden the wood, making the screws more secure.



- 9. Secure the rudder servo in the fuselage using the screws provided with the servo and a #1 Phillips screwdriver.



- 10. Slide a pushrod connector on the 19¹¹/₁₆-inch (500mm) pushrod wire.

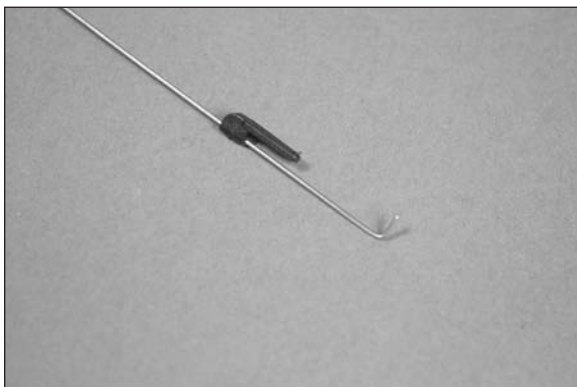

- 11. Insert the pushrod wire into the outside hole of the control horn. Slide the rudder pushrod in the hole of the pushrod connector. Use pliers to open the pushrod keeper just enough to slip it over the bend of the pushrod wire so it secures the pushrod wire to the control horn. Don't open the connector too far as it could possibly break the connector.



- 12. Center the rudder and the rudder servo. Use a 2mm x 4mm machine screw to secure the pushrod wires in the pushrod connector. Use a #1 Phillips screwdriver to tighten the screw. Use side cutters to trim the excess length of the pushrod wire so it does not interfere with the operation of the servo.



Landing Gear Installation

Required Parts

- Nose gear wire Wheel collar (7)
- Main gear wire, left
- Main gear wire, right
- 3mm x 3mm setscrew
- Landing gear strap (2)
- Nose gear steering arm
- 2mm x 8mm machine screw (7)
- Nose wheel, 1³/₁₆-inch (30mm)
- Main wheel, 1⁵/₈-inch (41mm) (2)
- 2mm x 8mm sheet metal screw (4)

Required Tools and Adhesives

- Phillips screwdriver: #1
- Hex wrench: 1.5mm Threadlock

- 1. Insert the main landing gear into the notch in the wing. The wire will fit flush with the wing when installed. There is a left and right main gear wire. When positioned correctly the spring coil will face the rear as shown in the photos.



- ○ 2. Use a #1 Phillips screwdriver to tighten the two 2mm x 8mm sheet metal screws that secure the landing gear strap to the bottom of the wing. The holes for the straps are pre located in the wing.



- ○ 3. Slide a wheel collar on the main landing gear and use a #1 Phillips screwdriver and 2mm x 8mm machine screw to secure the wheel collar to the wire. The wheel collars have a slight flange which faces toward the wheel. Make sure to install the wheel collars in the correct direction.



E-tips

Always use threadlock on metal-to-metal fasteners to prevent them from vibrating loose.

- ○ 4. Slide a main wheel and wheel collar onto the landing gear wire. Use a #1 Phillips screwdriver and 2mm x 8mm machine screw to secure the wheel. Remember to use threadlock on the screw to prevent it from vibrating loose.



E-tips

Leave a very small gap between the wheels and each collar to allow the wheel to roll freely.

- 5. Repeat Steps 1 through 4 to install the remaining main gear wire and wheel.
- 6. Position a wheel collar on the nose gear wire as shown and thread a 2mm x 8mm machine screw in the wheel collar. Note that the flange on the collar faces away from the spring on the nose gear wire. Do not tighten the screw at this time.

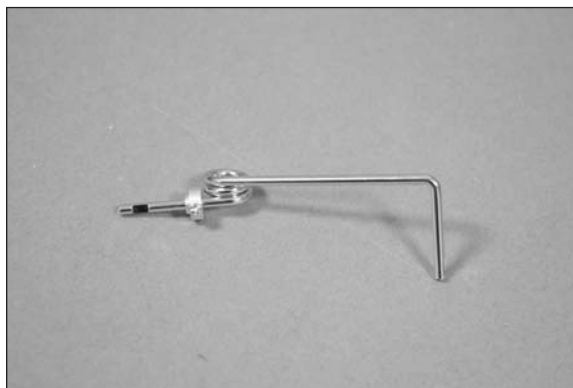

- 7. Install the nose wheel on the nose gear wire using two wheel collars and a #1 Phillips screwdriver to tighten the two 2mm x 8mm machine screws.

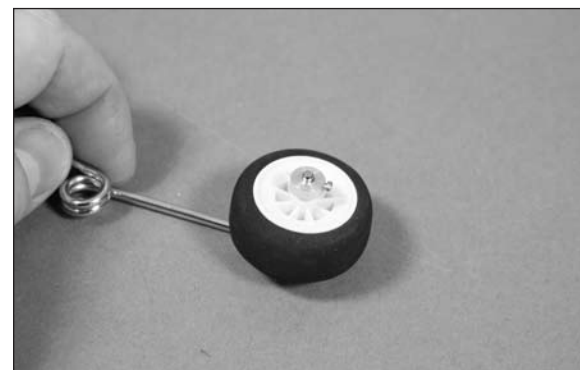
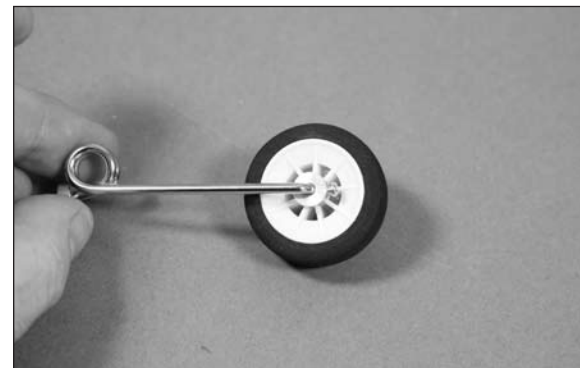

- 8. Slide the nose gear wire into the bushing in the front of the fuselage. The gear will angle forward as shown in the photo.

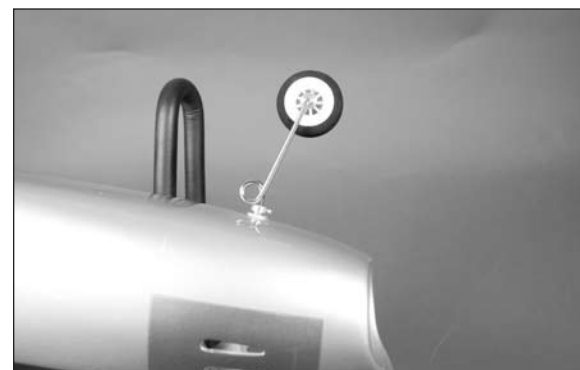

E-tips

During manufacturing the end of the nose gear wire may be slightly enlarged due to cutting. If this happens use a file to reduce the diameter of the end of the wire so that it slides smoothly through the bushings.

- 9. Slide the steering bellcrank on the nose gear wire from inside the fuselage. Use a 1.5mm hex wrench and 3mm x 3mm setscrew to secure the steering arm to the nose gear wire. The nose gear wire will fit flush at the top of the steering arm. The setscrew will tighten onto the flat spot of the nose gear that can be seen in the photo in Step 6. Make sure to use threadlock on the setscrew to prevent it from vibrating loose. Tighten the collar on the bottom so the nose gear turns freely but will not slide up and down on the bushing.



E-tips

Check to make sure the nose gear wire can move freely so the steering servo is not overloaded when trying to steer your aircraft.

Steering Servo and Linkage Installation

Required Parts

Assembled airframe Steering linkage
Transmitter Receiver
Steering servo Servo mount
Servo mounting strap
Nose gear pushrod wire, 7⁷/₈-inch (200mm)
2.5mm x 10mm sheet metal screw (4)

Required Tools and Adhesives

Pin vise Drill bit: 5/64-inch (2mm)
6-minute epoxy Mixing stick
Sandpaper Felt-tipped pen
Mixing cup Phillips screwdriver: #1

- 1. Insert the Z-bend for the nose gear pushrod wire into the steering bellcrank.

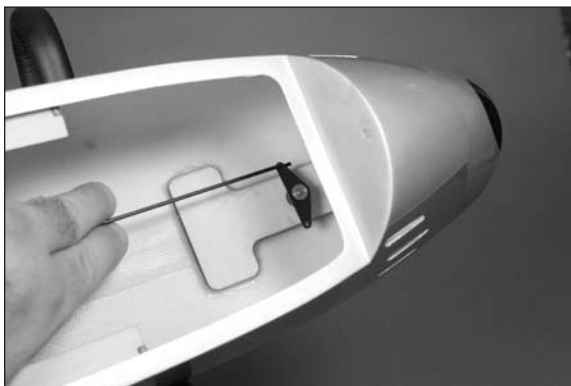
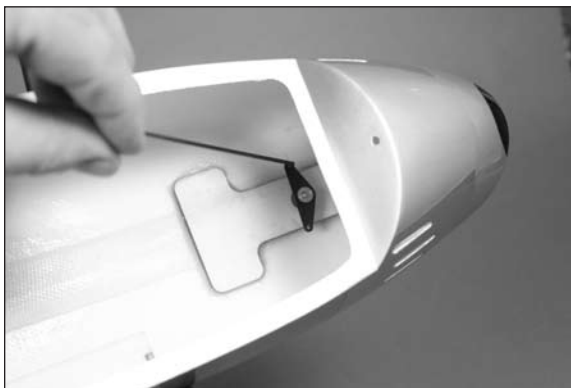

- 2. Use the radio system to center the steering servo. Note the direction of the servo arm in relationship to the servo.

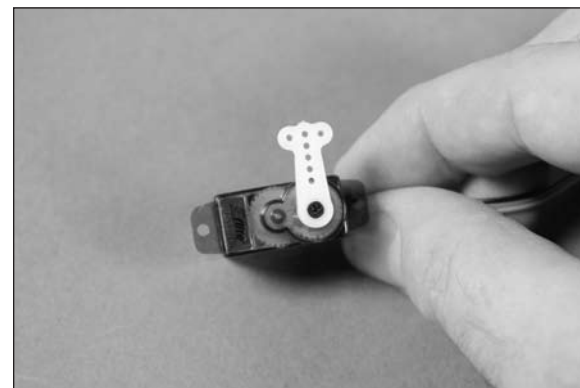

- 3. Use a pin vise and 5/64-inch (2mm) drill bit to enlarge the hole in the servo arm that is four holes away from the center of the servo arm as shown.

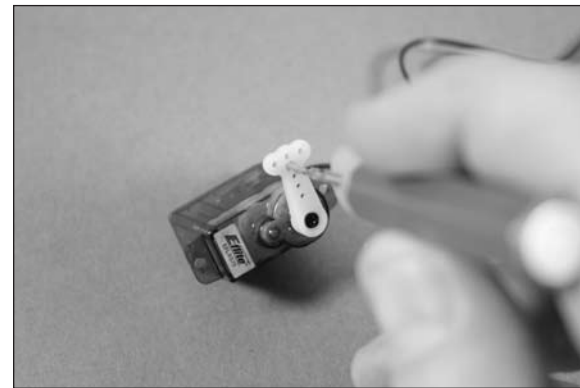

- 4. Insert the steering pushrod in the hole of the servo arm. Position the servo so the nose gear is aligned with the fuselage centerline so it will taxi straight down the runway. Use a felt-tipped pen to mark the fuselage where the servo rests.



- 5. Lightly sand the seam in the fuselage where the steering servo rests. This provides a flat area for the mount to be glued.



- 6. Use 6-minute epoxy to glue the servo mount in the fuselage. Once the epoxy fully cures, secure the servo using the servo mounting strap and two 2.5mm x 10mm sheet metal screws. Tighten the screws using a #1 Phillips screwdriver.



E-tips

Check to make sure the nose gear wire can move freely so the steering servo is not overloaded when trying to steer your aircraft.

Speed Control and Receiver Installation

Required Parts

Assembled airframe
Speed control Receiver
Hook and loop tape

Required Tools and Adhesives

Hobby scissors

- 1. Cut a piece of hook and loop tape and apply it to the bottom of the speed control as shown. Leave the adhesive backing on the mating hook and loop until instructed to do so.

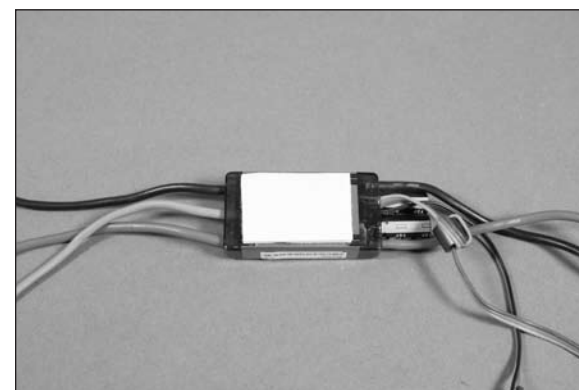

- 2. Remove the backing from the hook and loop tape on the speed control. Secure the speed control inside the fuselage as shown.



Note: When flying your model in locations where the air temperature is very high, you will need to mount the ESC between the wing rods. Cut a hole in the bottom of the fuselage so the fins of the ESC can be exposed to the air flow outside of the fuselage. This keeps the ESC cool and prevents over-heating.

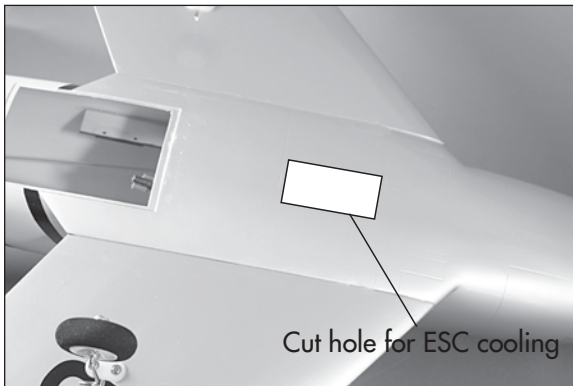
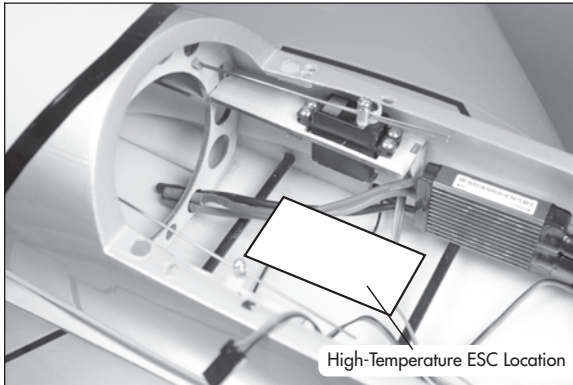

- 3. Insert the leads from the speed control through the hole in the former in the fuselage as shown.



- 4. Use a small amount of hook and loop tape to mount the switch from the speed control to the side of the fuselage. Make sure to position it where it can be easily accessed.



-

- 5. Cut two pieces of hook and loop tape and apply it to the bottom of the main and remote receivers as shown. Leave the adhesive backing on the mating hook and loop until instructed to do so.

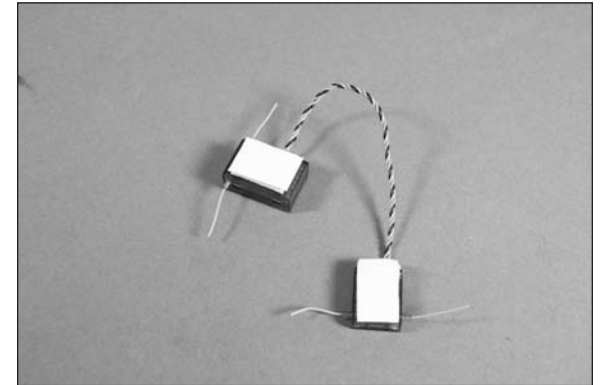

- 4. Plug the leads from the aileron servos, elevator servo, steering servo and speed control into the appropriate ports of the receiver. Use hook and loop tape to attach the receiver inside the fuselage as shown in the photo.

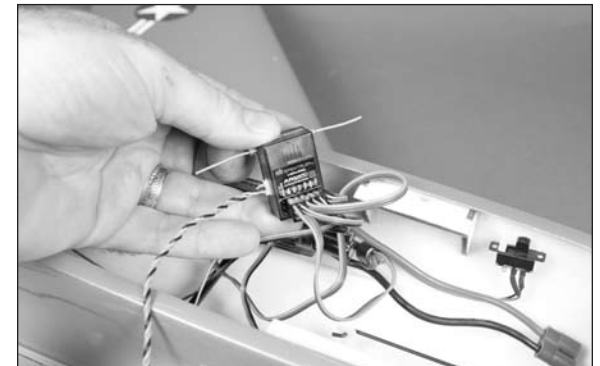

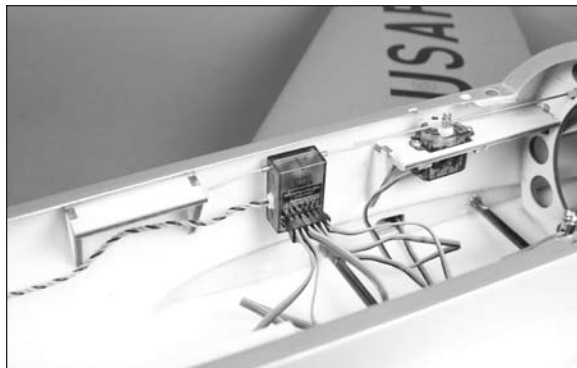

- 5. When installing a remote receiver, attach it as shown in the fuselage using hook and loop tape.



Intake Tube Installation

Required Parts

Assembled airframe

Intake tube

Hook and loop strap

- 1. Remove the cover from the bottom of the fuselage and set it aside in a safe location.



- 2. Prepare the hook and loop strap by attaching the pieces together using a 2-inch (52mm) overlap as shown.

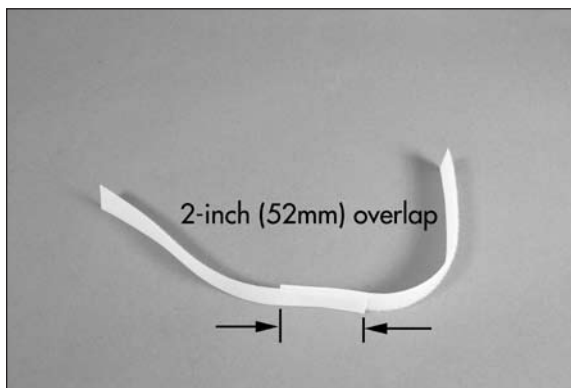

- 3. Locate the intake tube. The circular end will fit to the rear of the fuselage. The front is egg-shaped to match the intake of the fuselage and the flatter side will face to the bottom of the fuselage.



- 4. Place the hook and loop tape on the intake tube at this time. This will prevent you from accidentally looping the tape around the steering linkage wire.

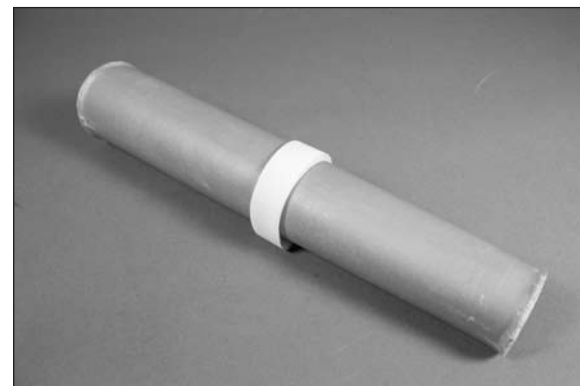

- 5. Insert the intake tube into the fuselage. Slide it forward so it keys to the intake of the fuselage. The tube will be secured after the fan has been installed.

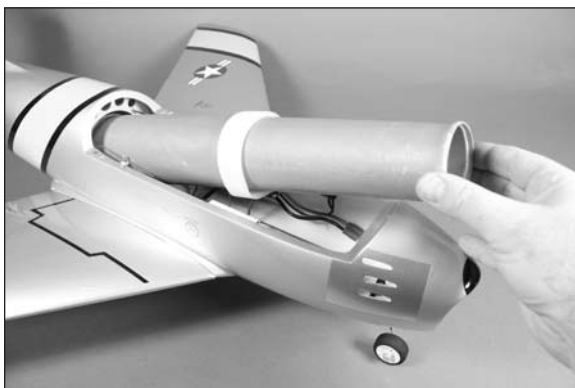

Fan Installation

Required Parts

| | |
|---------------------------------|--------------------|
| Fan assembly | Assembled airframe |
| Exhaust tube | Fan fairing |
| 2mm x 6mm machine screw (2) | |
| 2mm x 8mm sheet metal screw (4) | |

Required Tools and Adhesives

| | |
|-----------------|--------------------------|
| Felt-tipped pen | Hobby scissors |
| Thin CA | Phillips screwdriver: #1 |
| Paper | Low-tack tape |

- 1. Locate the fan unit. View the fan unit and use the drawing provided to determine the top and bottom of the fan. Place a piece of low-tack tape on the bottom of the fan so the bottom can easily be determined during assembly.

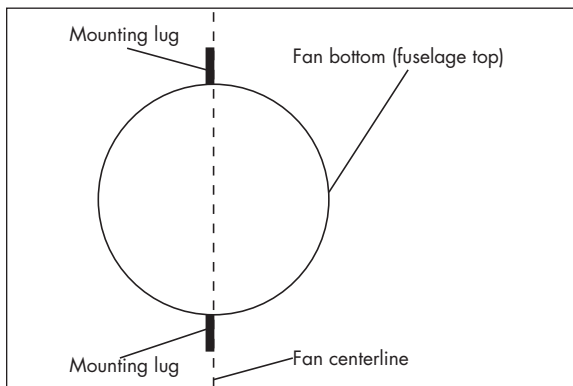

- 2. Pass the wires through the fan fairing.



- 3. Use two 2mm x 6mm machine screws and a #1 Phillips screwdriver to attach the fan fairing to the motor. Note that the fairing faces to the bottom of the fan unit.



- 4. Cut a paper template to locate where the fan fairing will exit the exhaust tube. Make sure the template fits tightly against the mounting lugs as the overall width of the template will be used for positioning.



- 5. Use a felt-tipped pen to mark the edge of the fan unit on the template. Make a mark for both of the mounting lugs.

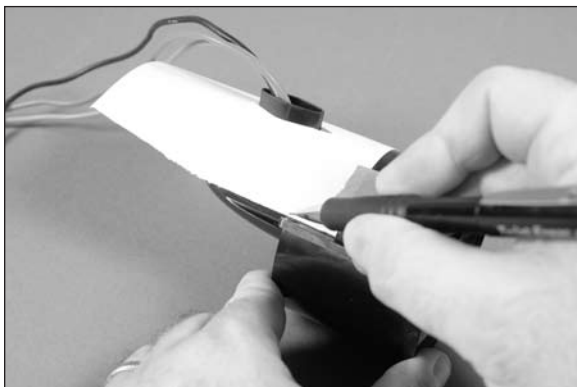

- 6. Align the template on the exhaust tube. The marks made in the previous step will align with the notches in the tube for the mounting lugs. Make sure the template is on the side of the exhaust tube with the seam (bottom). Use a felt-tipped pen to trace the outline for the fan fairing on the exhaust tube.

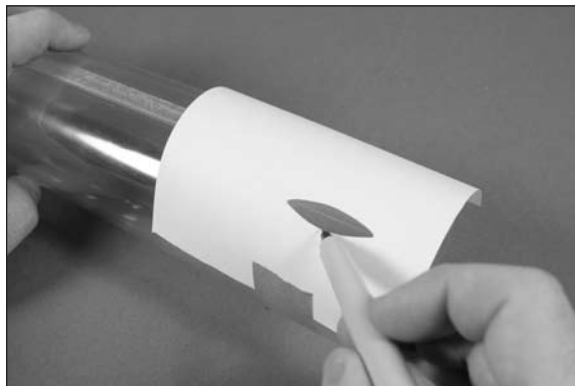

- 7. Remove the template from the exhaust tube. Use hobby scissors to trim the exhaust tube for the fan fairing. Slot the exhaust tube so it can be slid over the fan fairing.



- 8. Check the fit of the exhaust tube on the fan unit. It may be necessary to trim the opening slightly using hobby scissors.



E-tips

Matching the colors between the ESC and motor when they are connected results in the correct motor direction if using all E-flite components.

- 9. Use a #1 Phillips screwdriver to thread a mounting screw into the four holes for mounting the fan unit.



- 10. Place 2–3 drops of thin CA in each hole to harden the surrounding wood. This hardens the wood, making the screws more secure.



- 11. Connect the wires from the motor to those coming from the speed control.



- 12. Fit the fan unit into the fuselage with the fan fairing facing to the bottom of the fuselage. Make sure to fit the fan into the intake tube and that all the screw holes for mounting the fan are visible through the mounting lugs. Secure the fan unit in the fuselage using four 2mm x 8mm sheet metal screws. Tighten the screws using a #1 Phillips screwdriver.



Exhaust Tube Installation

Required Parts

Assembled airframe
 Exhaust tube Clear tape
 Fan access hatch

Required Tools and Adhesives

Hobby scissors Felt-tipped pen

- 1. Carefully roll or fold the exhaust tube into the shape shown below. It is made of a durable clear plastic and will not be harmed by doing so.

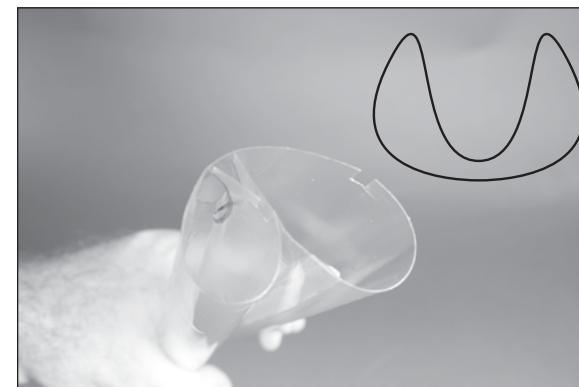

- 2. Slide the exhaust tube into the fuselage, with the wider end of the tube entering the fuselage from the rear. It will “pop” open when it has been inserted fully into the fuselage.

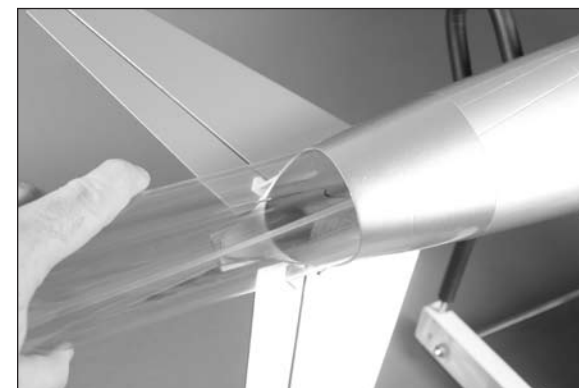

- 3. Position the exhaust tube so it overlaps onto the fan assembly.



- 4. Use a felt-tipped pen to trace the outline of the fuselage on the exhaust tube.



- 5. Remove the exhaust tube and use hobby scissors to trim the exhaust tube at the line drawn in the previous step to match the outline of the fuselage.



- 6. Insert the exhaust tube back into the fuselage. Use the clear tape supplied with your aircraft to tape the thrust tube to the fan housing.

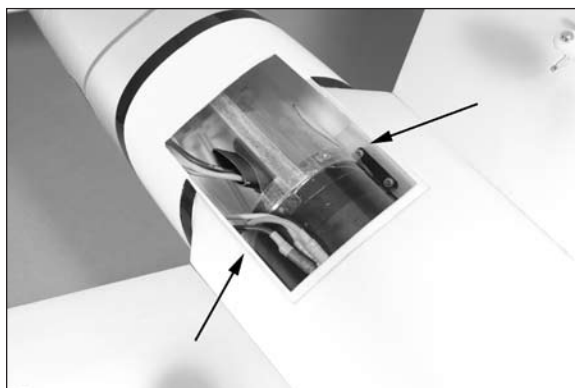

- 7. Use clear tape at the bottom and both sides of the thrust tube to secure the tube at the rear of the fuselage.



- 8. Cut four pieces of clear tape using scissors and tape the fan access hatch to the fuselage.

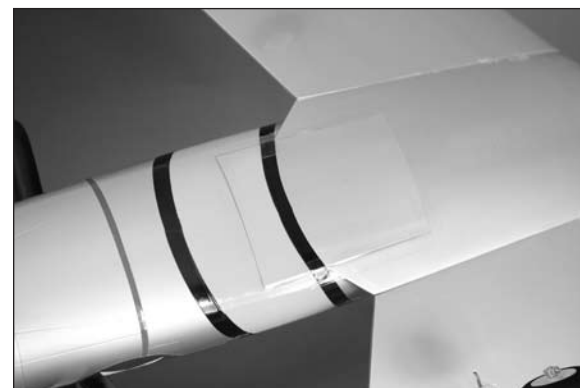

Securing the Intake Tube

Required Parts

Assembled airframe
Plywood intake mounting plate (2)
Plywood intake mounting gusset (4)
2mm x 6mm sheet metal screw (4)

Required Tools and Adhesives

| | |
|--------------|------------------------------|
| Medium CA | 6-minute epoxy |
| Mixing stick | Thin CA |
| Pin vise | Drill bit: 1/16-inch (1.5mm) |
| Mixing cup | Sandpaper |

- ○ 1. Use medium CA to glue the two plywood intake mounting gussets to the plywood plate. Note the position of the pieces in the photo.

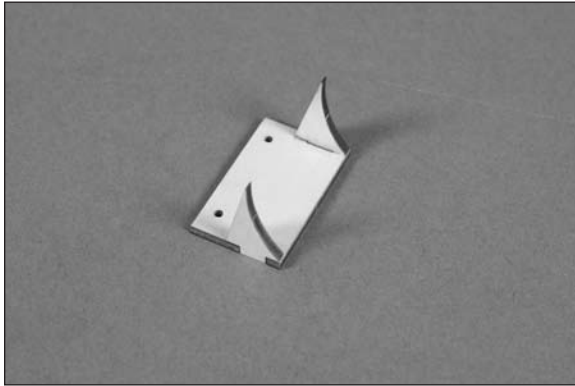

- ○ 2. Place the assembly on the rest in the fuselage. The gussets should rest lightly on the intake tube. If they are deforming the intake tube, you may need to sand the plywood plate or stop as necessary. Use a pencil to mark the location for the two screws that secure the plywood plate to the stop.



- ○ 3. Use a pin vise and 1/16-inch (1.5mm) drill bit to drill the two holes for the mounting screws.



- ○ 4. Use 2–3 drops of thin CA to harden the surrounding wood for the screws. This makes the screws more secure when they are installed.



- 5. Repeat Steps 1 through 4 to assemble and fit the remaining plywood plate and gussets.
- 6. Apply a small amount of 6-minute epoxy to the plywood gussets where they contact the intake tube. Insert the assembly into the fuselage and secure it to the rest in the fuselage using two 2mm x 6mm sheet metal screws and a #1 Phillips screwdriver. Install both assemblies at this time.



Canopy Assembly

Required Parts

Canopy hatch Cockpit
Clear tape Pilot figure (optional)

Required Tools and Adhesives

Hobby scissors

- 1. Use hobby scissors to trim the cockpit along the molded lines.

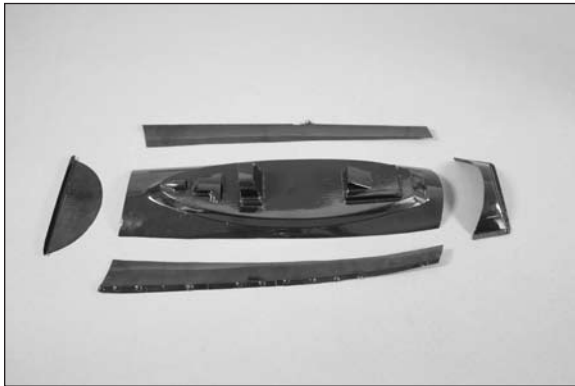

- 2. Insert the cockpit in the canopy hatch. It is best to insert the front first, then the rear will fit right in.

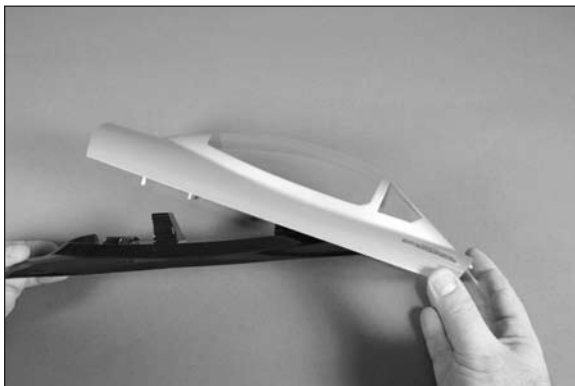

- 3. Use clear tape to hold the cockpit in the canopy hatch.

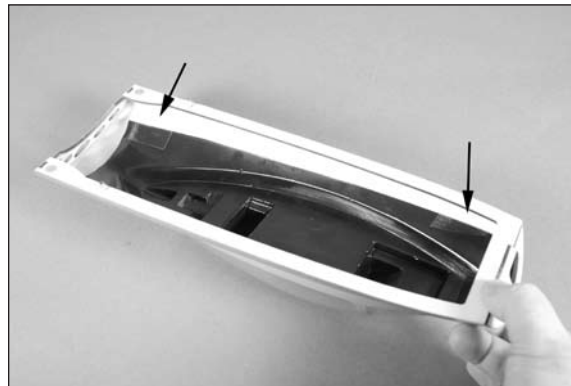

Optional Pilot

You may notice a pilot shown in the F-86 Sabre. A pilot is not included with the kit. It can be purchased separately under part number (PKZ7003). The pilot was cut down to fit and was glued in with canopy glue as shown before the cockpit was installed in the canopy hatch.

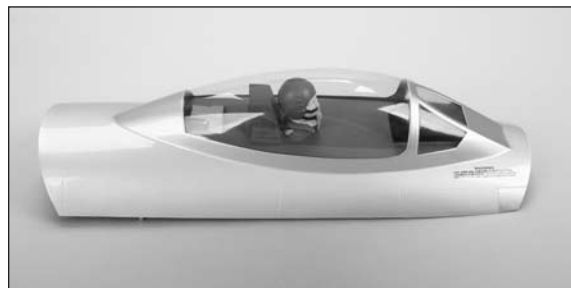

Motor Battery Installation

Required Parts

Motor battery Hook and loop tape
Assembled airframe
Canopy hatch assembly

Required Tools and Adhesives

Hobby scissors

- 1. Cut a piece of hook and loop tape that is 4¹/₂ inches (115mm) long. Apply the tape to the intake tube so it is centered on the top of the tube and positioned equally forward and backward of the intake mounting plates.



- 2. Apply the mating portion of the tape to the bottom of the motor battery as shown.



- 3. Position the motor battery in the fuselage and use the hook and loop strap to secure it inside the fuselage.



- 4. Place the canopy hatch on the fuselage.

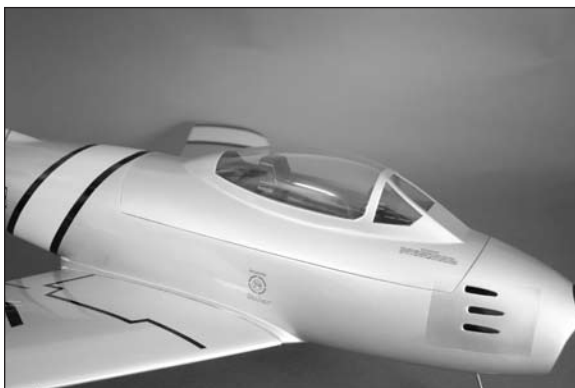

Decal Placement

Required Parts

Decal sheet Assembled airframe

Required Tools and Adhesives

Hobby scissors Hobby knife with #11 blade

- 1. Use hobby scissors and a hobby knife with a #11 blade to cut the decals from the decal sheet. Apply the decals to the airframe following one of the schemes shown. Drawings for decal placement are located on Page 43 of this manual.

Center of Gravity

An important part of preparing the aircraft for flight is properly balancing the model.

Caution: Do not inadvertently skip this step!

The recommended Center of Gravity (CG) location for your model is $5\frac{3}{4}$ to $6\frac{1}{8}$ inches (145 to 155mm) back from the leading edge of the wing as shown with the battery pack installed. Mark the location of the CG on the top of the wing with a felt-tipped pen.

When balancing your model, support the plane inverted at the marks made on the wing with your fingers or a commercially available balancing stand. This is the correct balance point for your model. Make sure your model is assembled and ready for flight before balancing.

Adjust the motor battery as necessary so the model is level or slightly nose down. This is the correct balance point for your model. You should find the CG to be very close with the battery installed as shown in this manual. Mark the location of the battery on the intake tube using a felt-tipped pen so it can be returned to this position if it is removed from your model.

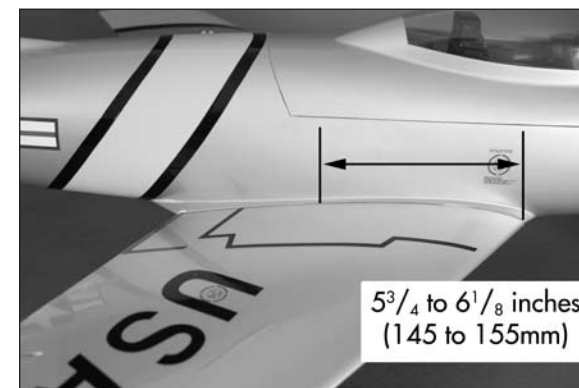

Control Throws

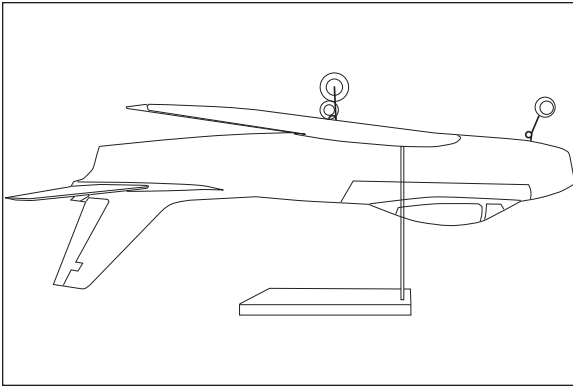

After the first flights, the CG position can be adjusted for your personal preference.

- 1. Turn on the transmitter and receiver of your model. Check the movement of the rudder using the transmitter. When the stick is moved right, the rudder should also move right. Reverse the direction of the servo at the transmitter if necessary.
- 2. Check the movement of the elevator with the radio system. Moving the elevator stick toward the bottom of the transmitter makes the airplane elevator move up.
- 3. Check the movement of the ailerons with the radio system. Moving the aileron stick right makes the right aileron move up and the left aileron move down.
- 4. Use a ruler to adjust the throw of the elevator, ailerons and rudder. Adjust the position of the pushrod at the control horn to achieve the following measurements when moving the sticks to their endpoints.

Elevator High Rate (100%)

| | | | |
|------|----------|--------|------------------|
| Up | 1/2-inch | (12mm) | +10% Exponential |
| Down | 1/2-inch | (12mm) | +10% Exponential |

Elevator Low Rate (70%)

| | | | |
|------|-----------|-------|-----------------|
| Up | 5/16-inch | (9mm) | +5% Exponential |
| Down | 5/16-inch | (9mm) | +5% Exponential |

Aileron High Rate (100%)

| | | | |
|------|----------|--------|------------------|
| Up | 3/8-inch | (10mm) | +10% Exponential |
| Down | 3/8-inch | (10mm) | +10% Exponential |

Aileron Low Rate (80%)

| | | | |
|------|-----------|-------|--------------------|
| Up | 9/32-inch | (7mm) | Linear Exponential |
| Down | 9/32-inch | (7mm) | Linear Exponential |

Rudder High Rate (100%)

| | | | |
|-------|----------|--------|------------------|
| Right | 3/8-inch | (10mm) | +10% Exponential |
| Left | 3/8-inch | (10mm) | +10% Exponential |

Rudder Low Rate (40%)

| | | | |
|-------|-----------|-------|-----------------|
| Right | 3/16-inch | (5mm) | +5% Exponential |
| Left | 3/16-inch | (5mm) | +5% Exponential |

E-tips

Adding spoilers to the F-86 Sabre during landing approach and landing will add washout affect and decrease the floating affect. Set both ailerons so they raise up 1/8-inch (3mm) above the trailing edge of the wing from center. Follow your computer radio instructions for the correct setup.

E-tips

The rudder low rate is used for takeoff and landing as the F-86 Sabre has a narrow stance gear. If using a computer radio it is also possible to use a mix and separate channel for the nose gear steering to create a low rate for just the nose gear.

E-tips

Measurements are taken at the inner or widest point on the control surface.

These are general guidelines measured from our own flight tests. You can experiment with higher rates to match your preferred style of flying.

E-tips

Travel Adjust and Sub-Trims are not listed and should be adjusted according to each individual model and preference.

Preflight

Check Your Radio

Before going to the field, be sure your batteries are fully charged per the instructions included with your radio. Charge the transmitter and motor battery for your airplane. Use the recommended charger supplied with your particular radio system, following the instructions provided with the radio. In most cases, the radio should be charged the night before going out flying.

Before each flying session, be sure to range check your radio. See your radio manual for the recommended range and instructions for your radio system. Each radio manufacturer specifies different procedures for their radio systems. Next, run the motor. With the model securely anchored, check the range again. The range test should not be significantly affected. If it is, don't attempt to fly! Have your radio equipment checked out by the manufacturer.

Double-check that all controls (aileron, elevator, rudder and throttle) move in the correct direction.

Check the radio installation and make sure all the control surfaces are moving correctly (i.e., the correct direction and with the recommended throws).

Check all the control horns, servo horns, and clevises to make sure they are secure and in good condition.

Flying Your F-86 Sabre 15 DF

You will find the agile F-86 is very capable in the air yet predictable on approach and landings.

As with all performance scale aircraft takeoff and landings must be performed smoothly with small control inputs. Take off using low rate steering and full power. Hold a small amount of up elevator during the takeoff roll and let the model fly off of the ground. After rotation, ease off of the up elevator and climb to altitude. Do not try to pull the model off of the ground too soon before it has a good amount of airspeed. Landings are best made by flying the model to the ground with a slight positive angle of attack. Use the throttle to control your descent and rudder to keep the model on heading.

The F-86 Sabre tracks very well in the air and is capable of many basic aerobatic maneuvers like loops, slow rolls, point rolls and inverted flight. We recommend you use throttle management during the whole flight. Using full power throughout the duration of the flight will result in shorter flight times and could result in a shorter life span for the electronics and batteries.

Happy Landings!

Range Test Your Radio

Before each flying session, and especially with a new model, it is important to perform a range check. It is helpful to have another person available to assist during the range check. If you are using a Spektrum transmitter, please refer to your transmitter's manual for detailed instructions on the range check process.

- 1. With the model resting on the ground, stand 30 paces (approximately 90 feet) away from the model.
- 2. Face the model with the transmitter in your normal flying position. Be sure the throttle is in the full down position and plug the flight battery into the speed control.
- 3. As you move the controls, watch to be sure the airplane's motor and controls operate smoothly. You should have total control of the model at 30 paces (90 feet).
- 4. If control issues exist, call the appropriate Horizon Product Support office (see page 40–41) or go to horizonhobby.com to find a local Spektrum distributor in your country for service if using a Spektrum radio system.

Safety Do's and Don'ts for Pilots

- Check all control surfaces prior to each takeoff.
- Do not fly your model near spectators, parking areas or any other area that could result in injury to people or damage of property.
- Do not fly during adverse weather conditions. Poor visibility can cause disorientation and loss of control of your aircraft. Strong winds can cause similar problems.
- Do not take chances. If at any time during flight you observe any erratic or abnormal operation, land immediately and do not resume flight until the cause of the problem has been ascertained and corrected. Safety can never be taken lightly.
- Do not fly near power lines.

Daily Flight Checks

- 1. Check the battery voltage of the transmitter battery. Do not fly below the manufacturer's recommended voltage. To do so can crash your aircraft.

E-tips

When you check these batteries, ensure you have the polarities correct on your expanded scale voltmeter.

- 2. Check all hardware (linkages, screws, nuts, and bolts) prior to each day's flight. Be sure that binding does not occur and that all parts are properly secured.
- 3. Ensure all surfaces are moving in the proper manner.
- 4. Perform a ground range check before each day's flying session.
- 5. Prior to starting your aircraft, turn off your transmitter, then turn it back on. Do this each time you start your aircraft. If any critical switches are on without your knowledge, the transmitter alarm will sound a warning at this time.
- 6. Check that all trim levers are in the proper location.
- 7. All servo pigtails and switch harness plugs should be secured in the receiver. Make sure the switch harness moves freely in both directions.

Warranty and Repair Policy

WARRANTY PERIOD

Exclusive Warranty- Horizon Hobby, Inc., (Horizon) warrants that the Products purchased (the "Product") will be free from defects in materials and workmanship at the date of purchase by the Purchaser.

LIMITED WARRANTY

Horizon reserves the right to change or modify this warranty without notice and disclaims all other warranties, express or implied.

(a) This warranty is limited to the original Purchaser ("Purchaser") and is not transferable. REPAIR OR REPLACEMENT AS PROVIDED UNDER THIS WARRANTY IS THE EXCLUSIVE REMEDY OF THE PURCHASER. This warranty covers only those Products purchased from an authorized Horizon dealer. Third party transactions are not covered by this warranty. Proof of purchase is required for warranty claims.

(b) Limitations- HORIZON MAKES NO WARRANTY OR REPRESENTATION, EXPRESS OR IMPLIED, ABOUT NON-INFRINGEMENT, MERCHANTABILITY OR FITNESS FOR A PARTICULAR PURPOSE OF THE PRODUCT. THE PURCHASER ACKNOWLEDGES THAT THEY ALONE HAVE DETERMINED THAT THE PRODUCT WILL SUITABLY MEET THE REQUIREMENTS OF THE PURCHASER'S INTENDED USE.

(c) Purchaser Remedy- Horizon's sole obligation hereunder shall be that Horizon will, at its option, (i) repair or (ii) replace, any Product determined by Horizon to be defective. In the event of a defect, these are the Purchaser's exclusive remedies. Horizon reserves the right to inspect any and all equipment involved in a warranty claim. Repair or replacement decisions are at the sole discretion of Horizon. This warranty does not cover cosmetic damage or damage due to acts of God, accident, misuse, abuse, negligence, commercial use, or modification of or to any part of the Product. This warranty does not cover damage due to improper installation, operation, maintenance, or attempted repair by anyone other than Horizon. Return of any goods by Purchaser must be approved in writing by Horizon before shipment.

DAMAGE LIMITS

HORIZON SHALL NOT BE LIABLE FOR SPECIAL, INDIRECT OR CONSEQUENTIAL DAMAGES, LOSS OF PROFITS OR PRODUCTION OR COMMERCIAL LOSS IN ANY WAY CONNECTED WITH THE PRODUCT, WHETHER SUCH CLAIM IS BASED IN CONTRACT, WARRANTY, NEGLIGENCE, OR STRICT LIABILITY. Further, in no event shall the liability of Horizon exceed the individual price of the Product on which liability is asserted. As Horizon has no control over use, setup, final assembly, modification or misuse, no liability shall be assumed nor accepted for any resulting damage or injury. By the act of use, setup or assembly, the user accepts all resulting liability.

If you as the Purchaser or user are not prepared to accept the liability associated with the use of this Product, you are advised to return this Product immediately in new and unused condition to the place of purchase.

Law: These Terms are governed by Illinois law (without regard to conflict of law principals).

Warranty Services

QUESTIONS, ASSISTANCE, AND REPAIRS

Your local hobby store and/or place of purchase cannot provide warranty support or repair. Once assembly, setup or use of the Product has been started, you must contact Horizon directly. This will enable Horizon to better answer your questions and service you in the event that you may need any assistance. For questions or assistance, please direct your email to productsupport@horizonhobby.com, or call 877.504.0233 toll free to speak to a service technician.

INSPECTION OR REPAIRS

If this Product needs to be inspected or repaired, please call for a Return Merchandise Authorization (RMA). Pack the Product securely using a shipping carton. Please note that original boxes may be included, but are not designed to withstand the rigors of shipping without additional protection. Ship via a carrier that provides tracking and insurance for lost or damaged parcels, as Horizon is not responsible for merchandise until it arrives and is accepted at our facility. A Service Repair Request is available at www.horizonhobby.com on the "Support" tab. If you do not have internet access, please include a letter with your complete name, street address, email address and phone number where you can be reached during business days, your RMA number, a list of the included items, method of payment for any non-warranty expenses and a brief summary of the problem. Your original sales receipt must also be included for warranty consideration. Be sure your name, address, and RMA number are clearly written on the outside of the shipping carton.

WARRANTY INSPECTION AND REPAIRS

To receive warranty service, you must include your original sales receipt verifying the proof-of-purchase date. Provided warranty conditions have been met, your Product will be repaired or replaced free of charge. Repair or replacement decisions are at the sole discretion of Horizon Hobby.

NON-WARRANTY REPAIRS

Should your repair not be covered by warranty the repair will be completed and payment will be required without notification or estimate of the expense unless the expense exceeds 50% of the retail purchase cost. By submitting the item for repair you are agreeing to payment of the repair without notification. Repair estimates are available upon request. You must include this request with your repair. Non-warranty repair estimates will be billed a minimum of 1/2 hour of labor. In addition you will be billed for return freight. Please advise us of your preferred method of payment. Horizon accepts money orders and cashiers checks, as well as Visa, MasterCard, American Express, and Discover cards. If you choose to pay by credit card, please include your credit card number and expiration date. Any repair left unpaid or unclaimed after 90 days will be considered abandoned and will be disposed of accordingly. Please note: non-warranty repair is only available on electronics and model engines.

United States:

Electronics and engines requiring inspection or repair should be shipped to the following address:

Horizon Service Center
4105 Fieldstone Road
Champaign, Illinois 61822
USA

All other Products requiring warranty inspection or repair should be shipped to the following address:

Horizon Product Support
4105 Fieldstone Road
Champaign, Illinois 61822
USA

Please call 877-504-0233 or e-mail us at productsupport@horizonhobby.com with any questions or concerns regarding this product or warranty.

United Kingdom:

Electronics and engines requiring inspection or repair should be shipped to the following address:

Horizon Hobby UK
Units 1-4 Ployters Rd
Staple Tye
Harlow, Essex
CM18 7NS
United Kingdom

Please call +44 (0) 1279 641 097 or e-mail us at sales@horizonhobby.co.uk with any questions or concerns regarding this product or warranty.

Germany:

Electronics and engines requiring inspection or repair should be shipped to the following address:

Horizon Technischer Service
Hamburger Strasse 10
25335 Elmshorn
Germany

Please call +49 4121 46199 66 or e-mail us at service@horizonhobby.de with any questions or concerns regarding this product or warranty.

France:

Horizon Hobby SAS
14 Rue Gustave Eiffel
Zone d'Activité du
Réveil Matin
91230 Montgeron

Please call +33 (0) 1 60 47 44 70 with any questions or concerns regarding this product or warranty.

Compliance Information for the European Union

INSTRUCTIONS FOR DISPOSAL OF WEEE BY USERS IN THE EUROPEAN UNION

This product must not be disposed of with other waste. Instead, it is the user's responsibility to dispose of their waste equipment by handing it over to a designated collection point for the recycling of waste electrical and electronic equipment. The separate collection and recycling of your waste equipment at the time of disposal will help to conserve natural resources and ensure that it is recycled in a manner that protects human health and the environment. For more information about where you can drop off your waste equipment for recycling, please contact your local city office, your household waste disposal service or where you purchased the product.



Age Recommendation: 14 years or over. Not a toy. Not intended for use by children without direct adult supervision.

2010 Official Academy of Model Aeronautics Safety Code

GENERAL

1. A model aircraft shall be defined as a non-human-carrying device capable of sustained flight in the atmosphere. It shall not exceed limitations established in this code and is intended to be used exclusively for recreational or competition activity.
2. The maximum takeoff weight of a model aircraft, including fuel, is 55 pounds, except for those flown under the AMA Experimental Aircraft Rules.
3. I will abide by this Safety Code and all rules established for the flying site I use. I will not willfully fly my model aircraft in a reckless and/or dangerous manner.
4. I will not fly my model aircraft in sanctioned events, air shows, or model demonstrations until it has been proven airworthy.
5. I will not fly my model aircraft higher than approximately 400 feet above ground level, when within three (3) miles of an airport without notifying the airport operator. I will yield the right-of-way and avoid flying in the proximity of full-scale aircraft, utilizing a spotter when appropriate.
6. I will not fly my model aircraft unless it is identified with my name and address, or AMA number, inside or affixed to the outside of the model aircraft. This does not apply to model aircraft flown indoors.
7. I will not operate model aircraft with metal-blade propellers or with gaseous boosts (other than air), nor will I operate model aircraft with fuels containing tetranitromethane or hydrazine.

8. I will not operate model aircraft carrying pyrotechnic devices which explode burn, or propel a projectile of any kind. Exceptions include Free Flight fuses or devices that burn producing smoke and are securely attached to the model aircraft during flight. Rocket motors up to a G-series size may be used, provided they remain firmly attached to the model aircraft during flight. Model rockets may be flown in accordance with the National Model Rocketry Safety Code; however, they may not be launched from model aircraft. Officially designated AMA Air Show Teams (AST) are authorized to use devices and practices as defined within the Air Show Advisory Committee Document.
9. I will not operate my model aircraft while under the influence of alcohol or within eight (8) hours of having consumed alcohol.
10. I will not operate my model aircraft while using any drug which could adversely affect my ability to safely control my model aircraft.
11. Children under six (6) years old are only allowed on a flightline or in a flight area as a pilot or while under flight instruction.
12. When and where required by rule, helmets must be properly worn and fastened. They must be OSHA, DOT, ANSI, SNELL or NOCSAE approved or comply with comparable standards.

RADIO CONTROL

1. All model flying shall be conducted in a manner to avoid over flight of unprotected people.
2. I will have completed a successful radio equipment ground-range check before the first flight of a new or repaired model aircraft.

3. I will not fly my model aircraft in the presence of spectators until I become a proficient flier, unless I am assisted by an experienced pilot.
4. At all flying sites a line must be established, in front of which all flying takes place. Only personnel associated with flying the model aircraft are allowed at or in front of the line. In the case of airshows demonstrations straight line must be established. An area away from the line must be maintained for spectators. Intentional flying behind the line is prohibited.
5. I will operate my model aircraft using only radio-control frequencies currently allowed by the Federal Communications Commission (FCC). Only individuals properly licensed by the FCC are authorized to operate equipment on Amateur Band frequencies.
6. I will not knowingly operate my model aircraft within three (3) miles of any preexisting flying site without a frequency-management agreement. A frequency management agreement may be an allocation of frequencies for each site, a day-use agreement between sites, or testing which determines that no interference exists. A frequency-management agreement may exist between two or more AMA chartered clubs, AMA clubs and individual AMA members, or individual AMA members. Frequency-management agreements, including an interference test report if the agreement indicates no interference exists, will be signed by all parties and copies provided to AMA Headquarters.
7. With the exception of events flown under official AMA rules, no powered model may be flown outdoors closer than 25 feet to any individual, except for the pilot and located at the flightline.

8. Under no circumstances may a pilot or other person touch a model aircraft in flight while it is still under power, except to divert it from striking an individual.
9. Radio-controlled night flying is limited to low-performance model aircraft (less than 100 mph). The model aircraft must be equipped with a lighting system which clearly defines the aircraft's attitude and direction at all times.
10. The operator of a radio-controlled model aircraft shall control it during the entire flight, maintaining visual contact without enhancement other than by corrective lenses that are prescribed for the pilot. No model aircraft shall be equipped with devices which allow it to be flown to a selected location which is beyond the visual range of the pilot.

F-86 Sabre 15 DF Safe Operating Recommendations

- Inspect your model before every flight to make certain it is airworthy.
- Be aware of any other radio frequency user who may present an interference problem.
- Always be courteous and respectful of other users of your selected flight area.
- Choose an area clear of obstacles and large enough to safely accommodate your flying activity.
- Make certain this area is clear of friends and spectators prior to launching your aircraft.
- Be aware of other activities in the vicinity of your flight path that could cause potential conflict.
- Carefully plan your flight path prior to launch.
- Abide by any and all established AMA National Model Aircraft Safety Code.

YELLOW

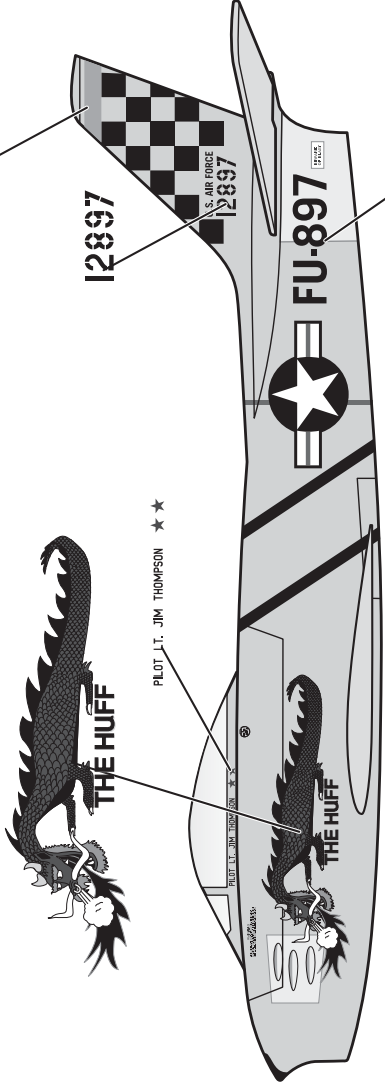

FU-897

RED

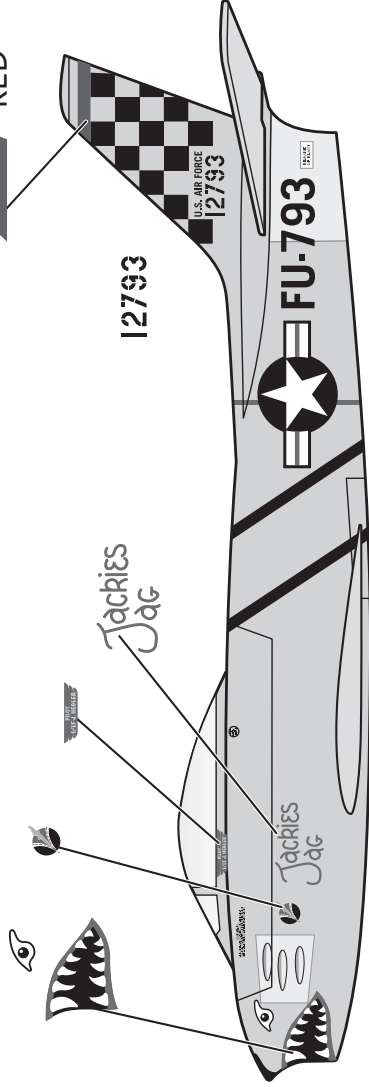

FU-793

BLUE

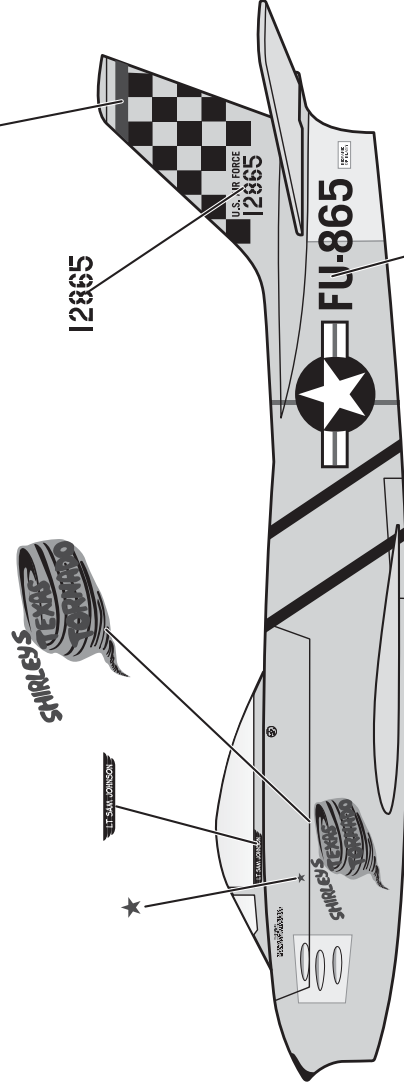

FU-865



© 2010 Horizon Hobby, Inc.
horizonhobby.com
www.e-fliterc.com