

# Futaba

DIGITAL PROPORTIONAL  
RADIO CONTROL

## INSTRUCTION MANUAL

D60493



FP-2PB

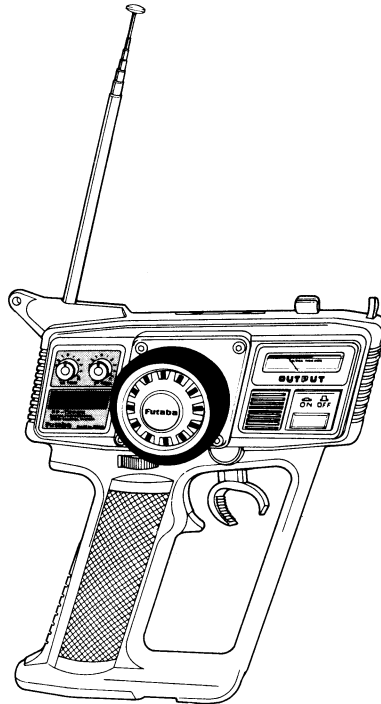

FP-2PBK

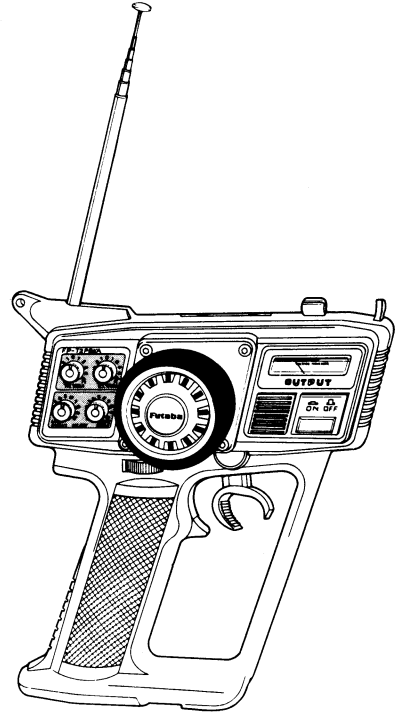

FP-2PBKA

# FP-2PB FP-2PBK FP-2PBKA

- FP-2PB/2PBK/2PBKA is a high performance 2 channel digital proportional R/C set and has built-in BEC (Battery Eliminator Circuitry) system.

Since the power of receiver and servo power is supplied from the running Nicd battery, there is no troublesome wiring and the vehicle can be made lighter.

Thank you for purchasing a Futaba digital proportional radio control set.  
Please read this manual carefully before using your set.

Thank you for purchasing a Futaba digital proportional radio control set.  
Please read this manual carefully before using your set.

## CONTENTS

FEATURES .....	1
COMPOSITION AND RATINGS .....	1
TRANSMITTER FP-T2PB/T2PBK/T2PBKA .....	2
LOADING THE PENLIGHT BATTERIES .....	5
CRYSTAL REPLACEMENT .....	5
STEERING TRIMMER ADJUSTMENT .....	6
RECEIVER AND SERVOS .....	7
FOR ELECTRIC MOTOR CAR .....	9
DIGITAL PROPORTIONAL FREQUENCIES (FOR USA) .....	10
CONVERSION TO NICAD SYSTEM FP-2PBKA ONLY .....	11
SERVO FP-S148 FP-S9601 .....	12
GUARANTEE/REPAIR SERVICE .....	12
FP-S132H WHEN NOT RUNNING .....	13
SPLINED HORN .....	13

### FEATURES OF FP-2PB/2PBK/2PBKA

FP-2PB/2PBK/2PBKA has a BEC function

- The BEC (Battery Eliminator Circuitry) system is a high performance constant voltage circuit (regulator). Since the running Nicd battery can also be used as the receiver servo power supply, there is no troublesome wiring and the vehicle can be made lighter.
- The FP-2PB/2PBK/2PBKA is the highest class pistol grip type AM 2 channel digital proportional R/C set.

### TRANSMITTER

- Newly designed cockpit type control panel.
- Easy to use size and design based on human engineering.
- Mechanical ATL (Adjustable Throttle Limiter) on throttle trigger. Because the reverse (brake) stroke of the throttle trigger can be mechanically varied continuously, reverse (brake) linkage is easy.
- Throttle ATV  
The throttle servo travel volume can be adjusted and set with two trimers, independently. (FP-T2PBKA)
- Steering rate adjuster. The left and right servo throws can be adjusted simultaneously even while running (T2PBK/T2PBKA)
- Servo reverse switches (steering & throttle). Since each servo can be switched between forward and reverse from the outside of the transmitter, linkage hookup is extremely easy.
- Level meter shows the state of the battery at a glance.
- Crystal can be changed from the outside. (Except 72/75 MHz)

## RECEIVER FP-R112JE

- High performance AM 2 channel receiver with BEC in which miniature size and light weight have been achieved by using integrated circuits. (20% thinner and 20% lighter than the FP-R102JE)
- New RF circuit improves intermodulation interference substantially.
- Futaba full custom IC improves reliability considerably.
- Newly designed case is easy to install.
- High performance BEC system allows use with power supply voltages up to 8.4 V.

## RECEIVER FP-R102H

- Small, lightweight, and rugged high-performance 2-channel AM receiver miniaturized by careful use of the space between components on the PC board.
- Connector w/lead wire comes out from the same side so that waterproofing and mounting in the model are easy.
- FUTABA custom IC decoder increases reliability.
- New type miniature high reliability crystal socket pins increase reliability and allow replacement of the crystal from the outside of the receiver.
- Thick film gold plated connector pins eliminate poor contact and improve reliability against shock.

## SERVO FP-S148, S9601, S132H HIGH NEUTRAL LOW PROFILE SERVO

- Vibration and shock resistance have been improved further by using a direct wiring system which directly connects the servo amp, motor and potentiometer. (S148, S9601)
- The height of the servo has been reduced and high torque, high speed, and smooth movement equal to that of the coreless servo have been realized by using a new small, high-performance motor. (Output torque 42 oz-in <3 kg-cm> operating speed 0.22 sec/60°). (S148)
- New indirect drive/completely sealed potentiometer substantially improves vibration and shock resistance, and neutral accuracy.
- Unique Futaba power-saving custom IC provides high starting torque narrow dead band, and excellent trackability.
- Fiberglass PBT (polybutylene terephthalate) servo case is mechanically strong and is invulnerable to glow fuel.
- Strong polyacetyl resin precision servo gear featuring smooth operation, accurate neutral, and minimam backlash.
- Fiberglass epoxy PC board with THRU-THE-HOLE plating improves the servo amp vibration and shock resistance.
- Thick plated connector pins eliminate the problem of faulty contact, improve reliability against shock and vibration, and prevent reverse insertion.
- Special pad grommets simplify mounting of the servo, and are extremely vibration-resistant.
- Seven kind of special adjustable horns are available.
- High 42 oz-in (3kg-cm) output torque is perfect for almost all models. (S148)
- High operating speed of 0.13 sec/60° makes it perfect when especially high speed is necessary. (S132H)
- High quality double ball bearing servos using the highest quality coreless motor. Output torque 33.3 oz-in (2.4 kg-cm)  
Nominal operating speed 0.15 sec/60° (S9601)

## COMPOSITION AND RATINGS

### •COMPOSITION

	FP-2PB	FP-2PBK	FP-2PBKA
Transmitter	FP-T2PB x 1	FP-T2PBK x 1	FP-T2PBKA x 1
Receiver	FP-R112JE x 1	FP-R112JE x 1	FP-R112JE x 1 or FP-R102H x 1
Servo	FP-S148 x 2	FP-S148 x 2	FP-S148 x 2, FP-S9601 x 2 or FP-S132H x 2
Battery holder	R2-BSS · N		
Others	Switch, frequency flag, spare horn		

Ratings are subject to change without prior notice.

### •RATINGS

TRANSMITTER FP-T2PB/T2PBK/T2PBKA	
Operating system	Pistol grip, wheel type
Transmitting frequency	27 MHz band, 75 MHz band
Modulation type	AM (Amplitude Modulation)
Power requirement	12.0 V, penlight battery x 8
Current drain	170 mA

RECEIVER FP-R112JE	
Receiving frequency	27 MHz band, 75 MHz band
Intermediate frequency	455 kHz
Power supply voltage	4.8 V to 8.4 V (built-in BEC)
Current drain	8.4 V/10 mA, 4.8 V/30 mA (no signal)
Dimensions	1.87 x 1.24 x 0.62 in (47.6 x 31.5 x 15.7 mm) (excluding protruding parts and antenna)
Weight	0.72 oz (20.5 g)
Receiving range	330 yards (300 m) on the ground when FP-T2PBK used (At the best conditions)

RECEIVER FP-R102H	
Receiving frequency	27MHz, 75MHz bands
Intermediate frequency	455KHz
Receiving range	150m on the ground using the FP-T2PBKA
Power requirement	4.8V or 6.0V (shared with servos)
Current drain	6V, 11mA
Dimensions	1.09x1.52x0.66 in. (27.8x38.8x16.9mm)
Weight	0.77 oz (22g) (27MHz) 0.80 oz (23g) (75MHz)

SERVO FP-S148	
Control system	+pulse width control
Operating angle	One side 45° or more
Power requirement	4.8 V - 6 V
Current drain (IDLE)	6.0 V, 8 mA (at idle)
Output torque	42 oz. in. (3 kg-cm)
Operating speed	0.22 sec/60°
Dimensions	1.59 x 0.77 x 1.4 in. (40.4 x 19.8 x 36 mm)
Weight	1.56 oz. (44.4 g)

SERVO FP-S132H	
Operating system	Pulse width control, 1.520μs neutral
Operating angle	Rotary type, one side 40° or greater (including trim)
Power requirement	4.8 or 6.0V (shared with receiver)
Current drain	6.0V, 8mA (at idle)
Output torque	25.02 oz-in (1.8 kg-cm)
Operating speed	0.13 sec/60°
Dimensions	1.46x0.71x1.20 in (37x18x30.5 mm)
Weight	1.13 oz (32g)

SERVO FP-S9601	
Control system	+ pulse width control 1520 μs neutral
Operating angle	One side 45° min (including trim)
Power supply	6.0 V, shared with receiver
Current drain	6.0 V 12mA (at idle)
Output torque	33.3 oz-in (2.4 kg-cm)
Operating speed	0.15 sec/60°
Dimensions	1.22x0.63x1.19 in (31x16x30.2 mm)
Weight	1.09 oz (31g)

# TRANSMITTER FP-T2PB/T2PBK/T2PBKA

## ●Nomenclature

- The name of each part of the transmitter is shown in the figure. Learn them before operating your set.

When running the vehicle, extend the antenna fully.

Before using the set, check the remaining battery capacity by checking the level meter.

Good                      Caution                      No good  
Change the battery.

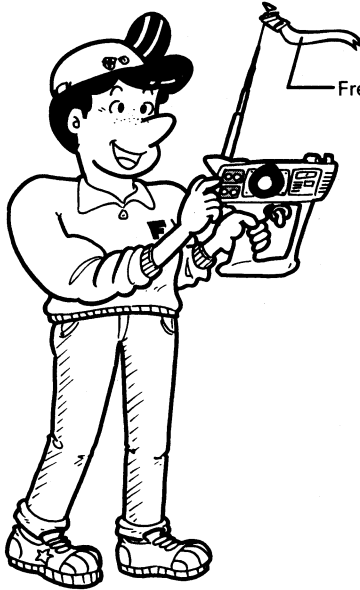

Frequency flag

Antenna

Throttle servo reversing switch

Throttle trimmer (T2PBK/T2PBKA)

Steering (rudder) servo reversing switch

Steering (rudder) trimmer

Level meter

Throttle ATV trimmer (T2PBKA)

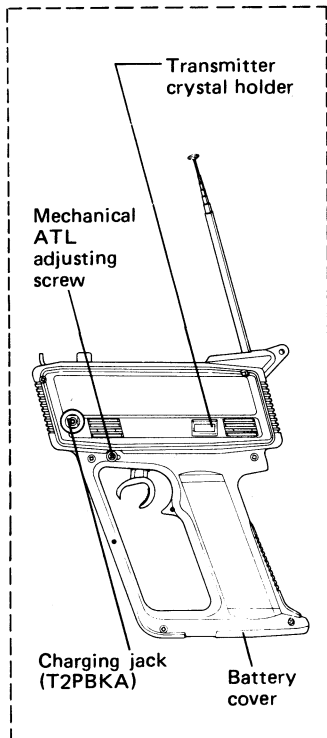

Steering rate adjuster (T2PBK/T2PBKA) or Throttle trim knob (T2PB)

Power switch

Throttle trigger (throttle)

Steering wheel (rudder)

▲ The servo reversing switches are assumed to be in the normal position in the descriptions below. When the reversing switches are in the reverse position, servo operation is the opposite of that described here.

- Steering wheel (rudder)  
Steering (rudder) operation.
- Throttle trigger (throttle lever)  
Engine control/motor control operation.

**Mechanical ATL (Adjustable Throttle Limiter) adjusting screws**

- Mechanical ATL allows mechanical setting of the reverse (brake) stroke of the throttle trigger.
- Loosen this screw with a small Phillips screwdriver and set the throttle trigger to the desired reverse (brake) stroke, then retighten the screw.
- Because the reverse (brake) stroke is continuously variable, reverse side linkage is easy. The adjustment range is 0 to 100% of the reverse stroke.

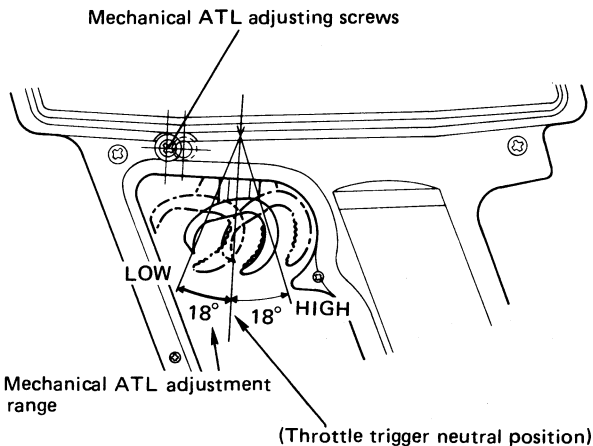

Mechanical ATL maximum position

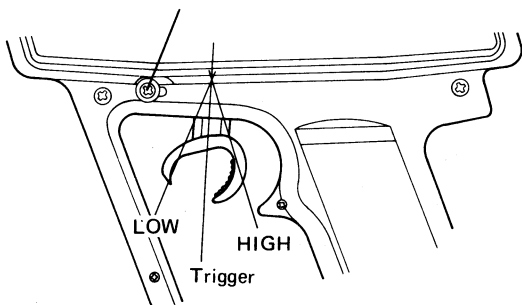

The throttle trigger can be operated over its full stroke. The throttle servo operates as shown in the figure.

Mechanical ATL minimum position

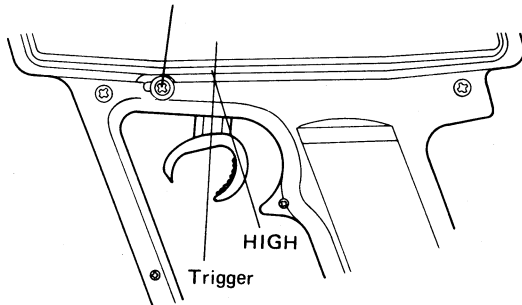

The throttle trigger can be operated only at the high side of the neutral position. The throttle as shown in the figure.

The throttle trigger reverse (brake) stroke can be adjusted over this range with the mechanical ATL adjusting screws.

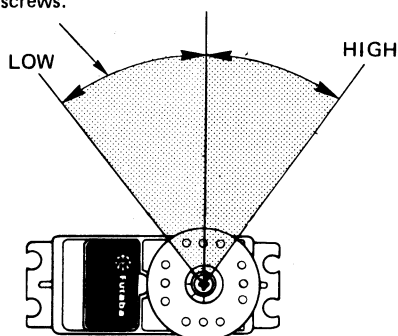

Throttle servo

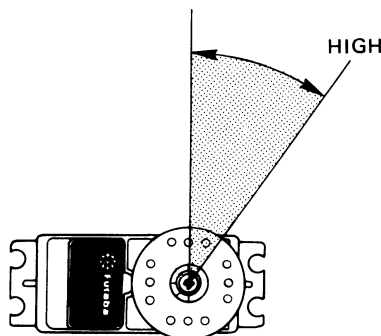

Throttle servo

- **Steering (rudder) trimmer**  
Steering (rudder) fine adjustment.

- **Steering rate adjuster (T2PBK/T2PBKA)**

The steering servo deflection angle can be freely set as shown in the figure with this ratchet type adjuster. It is installed where the deflection angle can be easily adjusted to match the course even while running.

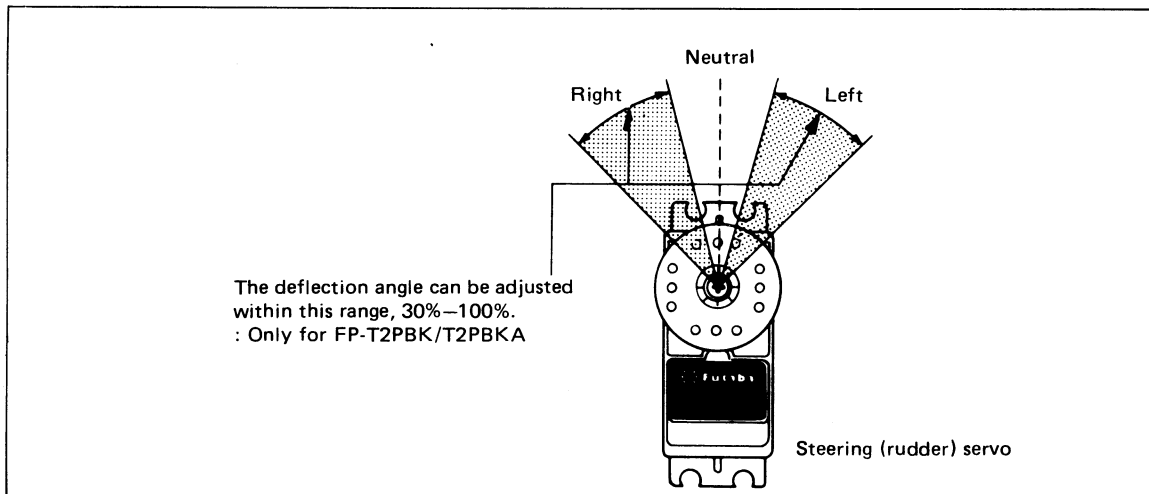

- **Throttle trimmer**

Throttle (engine control) fine adjustment.

- **Steering (rudder) servo reversing switch**

Reverses the direction of operation of the steering servo.

- **Throttle servo reversing switch**

Reverses the direction of operation of the throttle servo.

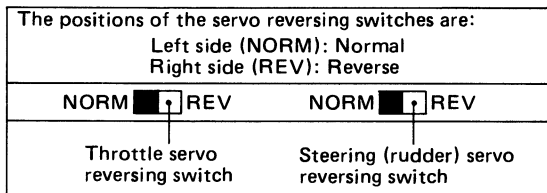

- **Power switch**

When this switch is pressed once, the power is turned on and the pointer of the level meter deflects. When the switch is pressed again, the power is turned off.

- **Throttle ATV trimmer**

ATV... Adjustable Travel Volume.

Throttle ATV is a device which permits independent adjustment of the throttle servo left and right sides (from neutral) as shown in this figure with trimmers Low (High) and High (Low). (FP-T2PBKA)

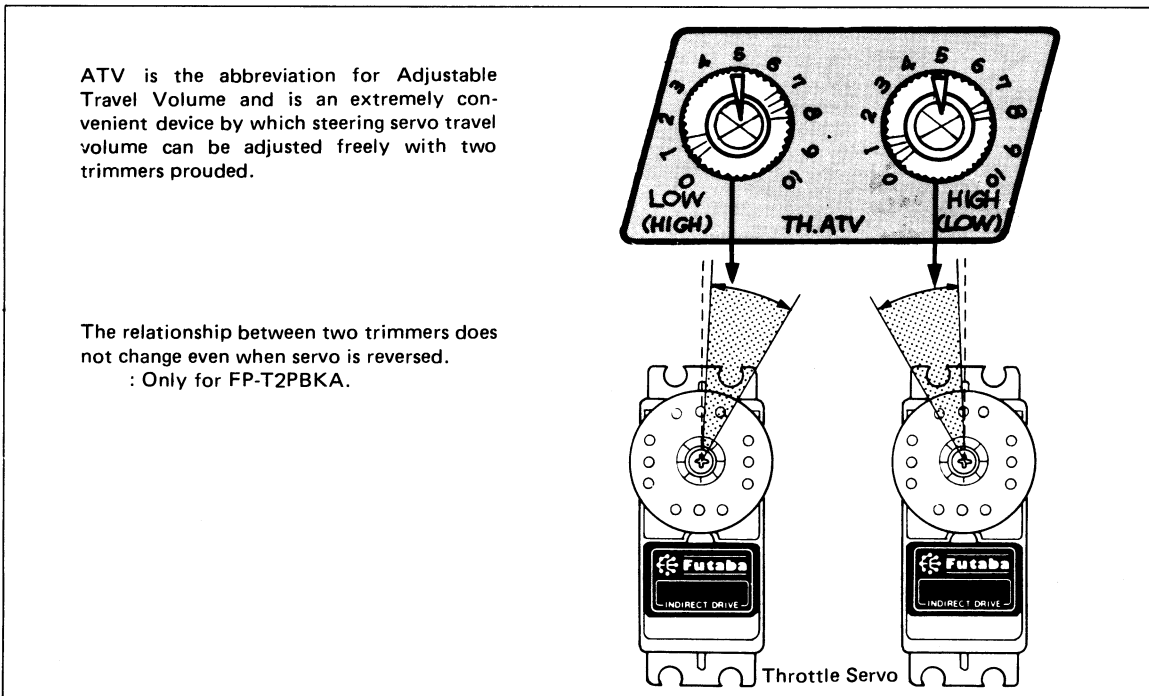

## ▲ LOADING THE PENLIGHT BATTERIES

- Remove the battery cover at the bottom and insert eight penlight batteries in the correct polarity.

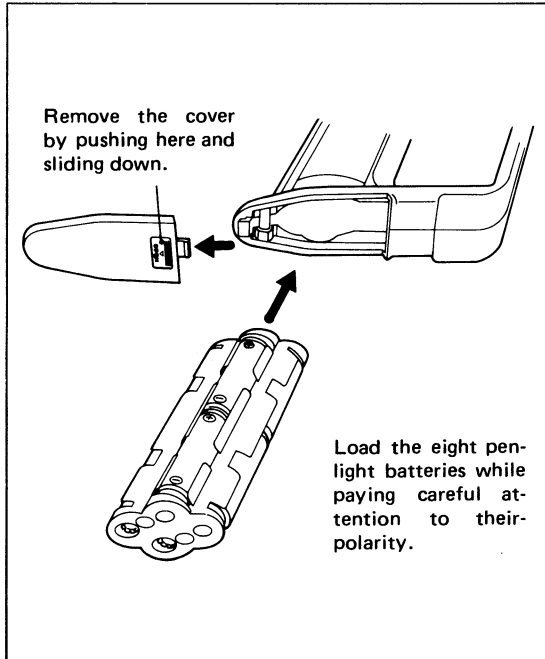

### ● Battery cover

When loading or changing the eight penlight batteries, remove this cover as shown in the figure.

### ● The antenna

The antenna is 95 cm long. Install it as shown in the figure.

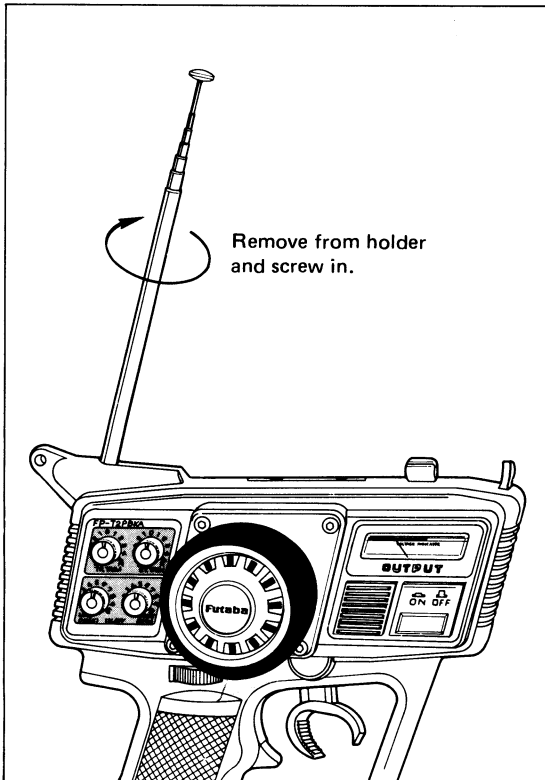

### ● Transmitter crystal

When changing the frequency, change the crystal. Use the AM crystal (transmitter and receiver pair) sold by Futaba. The transmitter crystal is marked TX and the receiver crystal is marked RX. You can not change from one band to another (27 MHz to 75 MHz) simply by changing crystals.

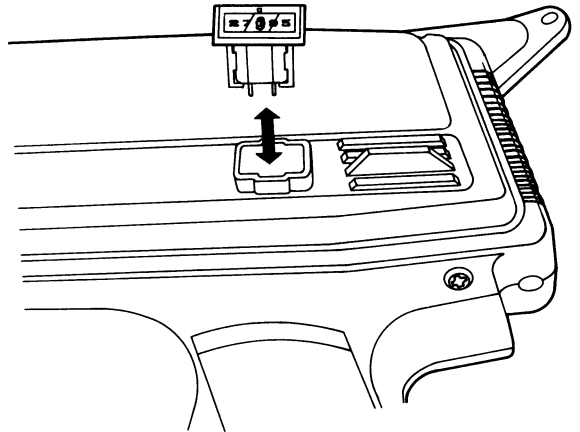

### ● Level meter

When the power switch is turned on, the meter pointer should move to the silver zone. If the pointer approaches the boundary between the silver and red zones, the battery voltage is low and the signal range will become shorter. When the meter pointer stops at the boundary between the silver and red zones, change the batteries.

- Extend the antenna fully and set the power switch to ON.

The level meter pointer should deflect to the silver zone. If the pointer does not move, or moves very little, check for poor battery contact, incorrect battery polarity, or faulty batteries.

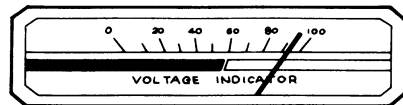

- If the pointer of the level meter deflects to the red zone, the range of the radio waves will become short. When the pointer drops to the boundary between the silver and red zones, change the batteries.

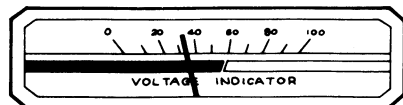

- The trim knobs are used to fine adjust the steering angle. They are used to adjust the neutral position and for correcting the running posture after the mechanism is mounted. After test running, make corrections with the rod adjuster, etc. and operate the set with the trim knobs in the neutral position as much as possible.

## ▲ Steering Trim Knob Adjustment

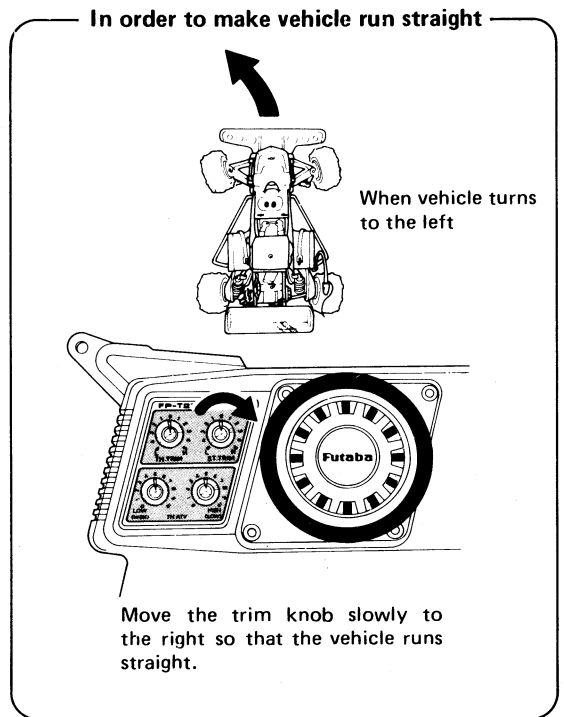
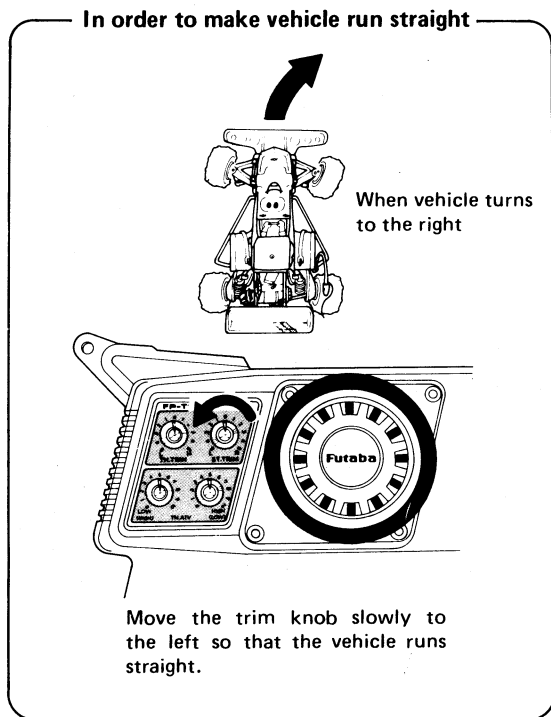

\*Adjust the trim knob so that the vehicle runs straight on a smooth road.

The throttle trim knob is used to fine adjust the speed controller stop position, etc.

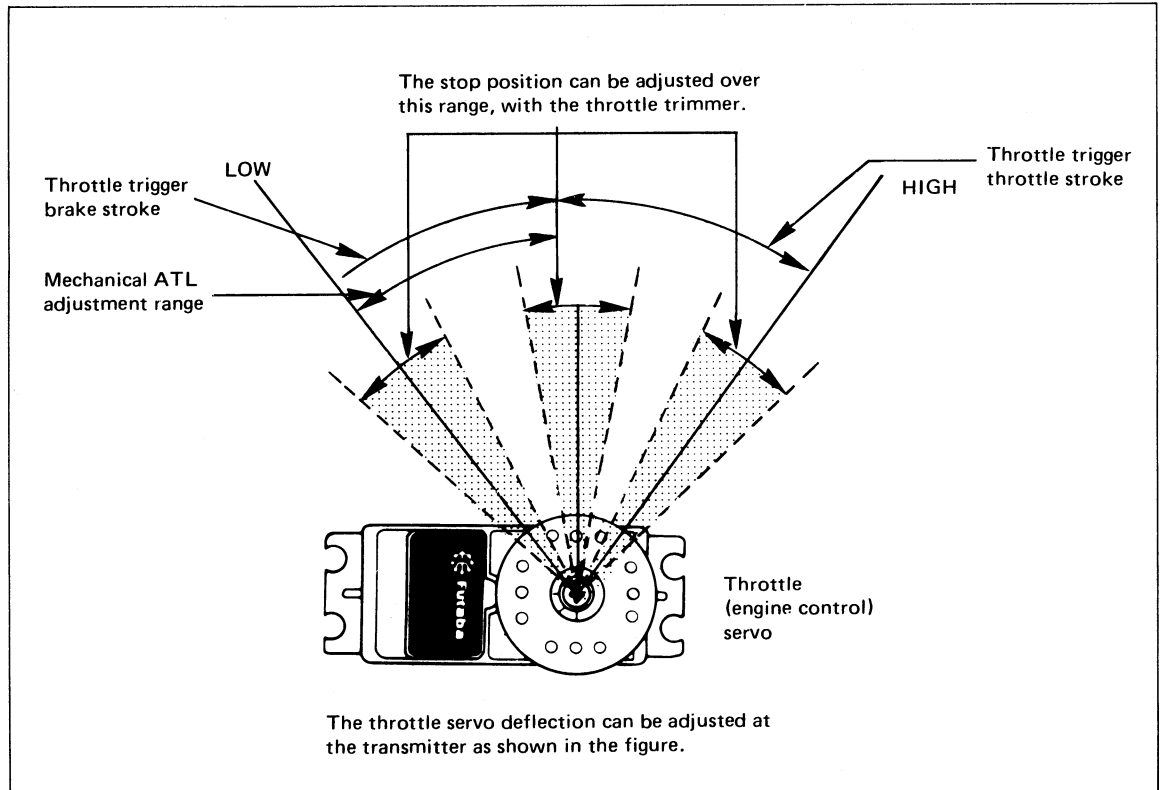





The **BEC** mark is displayed on the front of the receiver of BEC system sets with a receiver with shared power supply regulator.

## RECEIVER FP-R112JE AND SERVO FP-S148/S9601/S132H

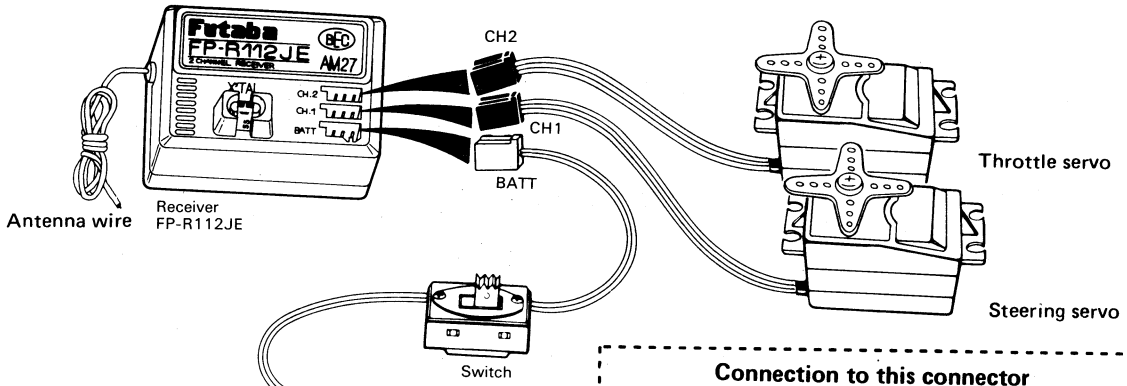

Connect the servo and switch as shown in the figure and extend the transmitter and receiver antenna fully.

### Connection to this connector

(1) When chassis power supply of engine or motor car is separate

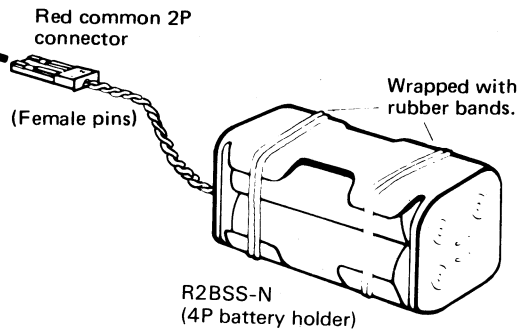

(3) When motor car uses an ordinary common power supply

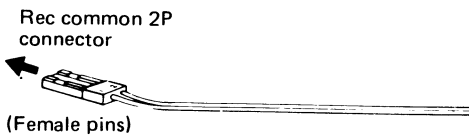

Buy the red common 2P connector from the kit manufacturer and connect to the controller.  
Pin 1: Minus  
Pin 2: Plus

(2) When motor car uses a special BEC system (common power supply specifications)

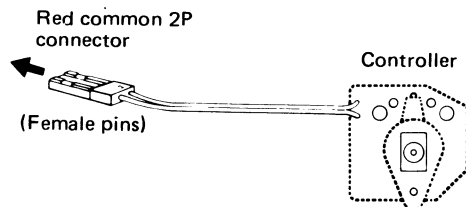

Connect to the red common 2P connector of the controller.

The Futaba BEC system can also use a common power supply with the conventional four penlight batteries system (separate power supply).

# RECEIVER FP-R102H AND SERVO FP-S132H

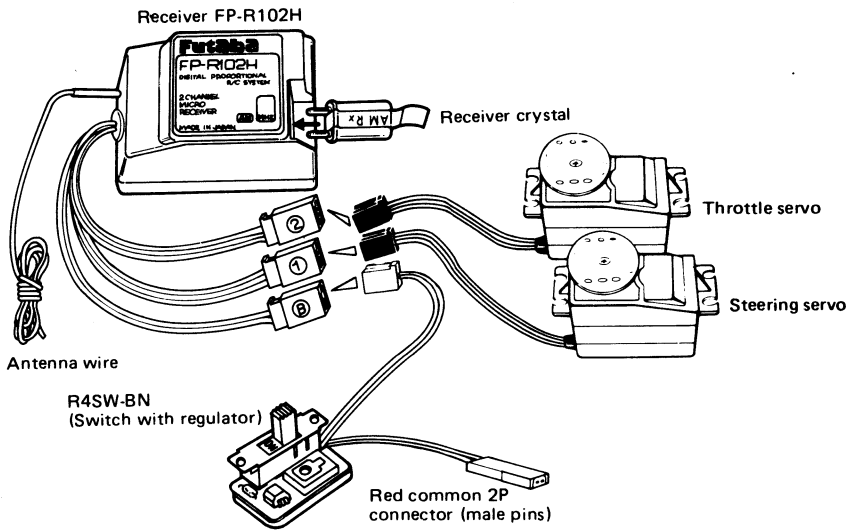

Connect the servo and switch as shown in the figure and extend the transmitter and receiver antenna fully.

● A common power supply regulator and diode may also be supplied with the speed controller, depending on the vehicle kit. Since they cause a voltage drop, always remove them.

● Set the transmitter power switch to ON, then set the receiver power switch to ON. The servos stop near the neutral position. Operate the transmitter wheel/trigger and check if each servo faithfully follows operation of the wheel/trigger.

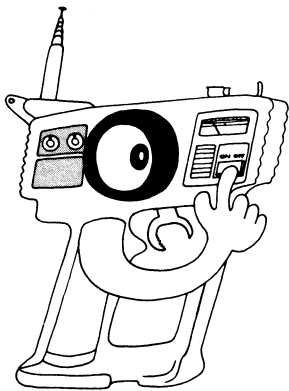

From transmitter when switch turned on

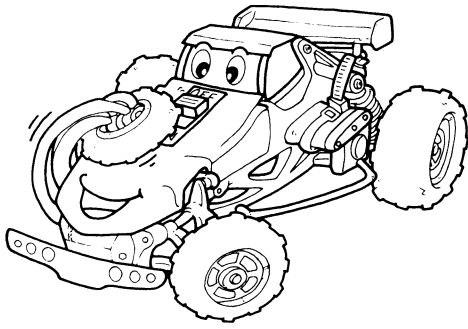

From receiver when switch turned off

● Connect the pushrod to each servo horn, then check if the direction of travel of each servo matches the transmitter operation.

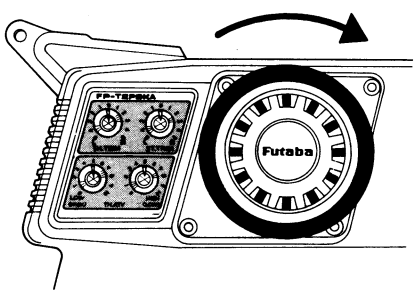

When the transmitter steering wheel was turned to the right

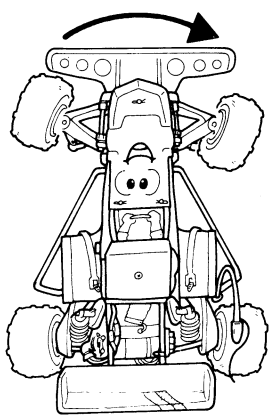

Vehicle also steers to the right

## ▲ FOR ELECTRIC MOTOR CAR

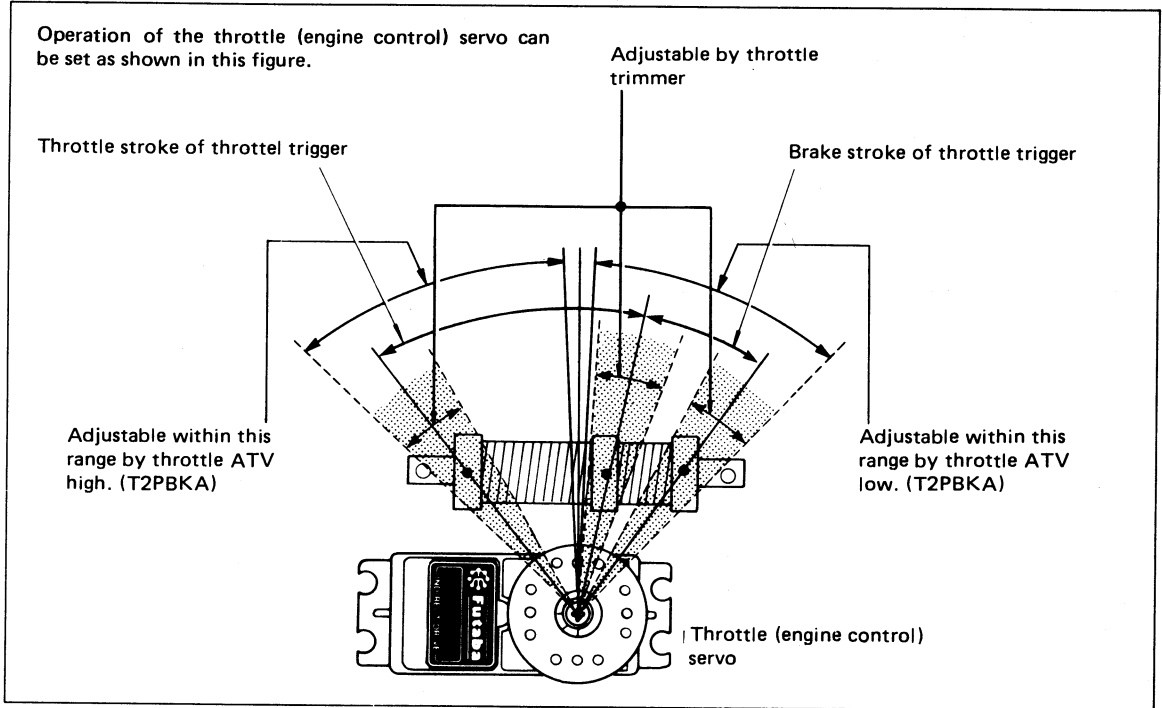

- Operate each servo over its full travel and check if the pushrod binds or is too loose. Applying unreasonable force to the servo horn will adversely affect the servo and quickly drain the battery. Be especially careful when using 8.4 V.
- Always make the full stroke (including trim) of the servo horns somewhat larger than the full travel. Adjust the servo horns so that they move smoothly even when the trim knobs and wheel/trigger are operated simultaneously in the same direction.
- Be alert for noise.  
Always solder a noise killing capacitor to the running motor. If metal parts touch each other due to vibration, noise will be generated and cause the receiver servos to operate erroneously. We recommend the use of noiseless parts.

- Even though the receiver antenna wire is long, do not cut or bundle it. The range of the radiowaves will be shortened.

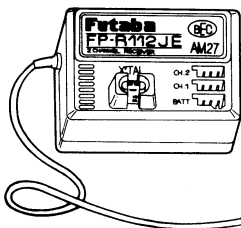

Scissors

Receiver antenna wire

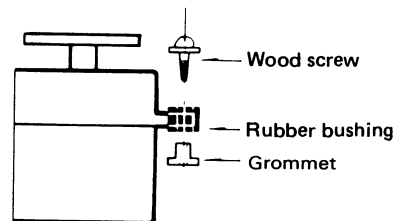

- Install the servos firmly. Install the servo to the servo tray as shown in the figure. In other cases, install the servo as described in the model manufacturer's manual.

- A spare horn is provided. Use it as required.
- Wrap the receiver in sponge rubber and wrap rubber bands around the sponge rubber. Mount the receiver so it is not exposed to vibration, does not touch the frame, and does not move.
- When the receiver is installed on a board or used where it may be splashed with mud and water, place it in a plastic bag, etc. and wrap a rubber band around the open end of the bag to waterproof and dustproof the receiver. After use, remove the receiver from the bag to prevent condensation. Please remember that melted snow turns to water.
- Use the rubber bands wrapped around the receiver to hold the servo and switch leads.
- After mounting is complete, recheck each part, then check the transmitting range by making the transmitter antenna as short as possible and extending the receiver antenna fully and operating the set from a distance of 20 m to 30 m. The movement of each servo should follow the movement of the transmitter wheel/trigger.
- The crystal can be changed from the outside of the receiver case. Always use a Futaba transmitter and receiver crystal pair as the replacement crystals.

## ▲ Digital Proportional Frequencies (FOR U.S.A.)

- The frequency of Futaba digital proportional sets can be changed within their own band. There are 2 different bands for you to choose from (27 MHz and 72-75 MHz.) Please see chart listed below for specific frequency and its intended use. Please note there are specific frequencies allocated for aircraft only and surface only use.
- The frequency can be changed within the same BAND by using a precisely matched pair of Futaba crystals. However, Futaba recommends that you return your system to our factory service department for frequency changing, as tuning may be necessary for proper operation. Changing frequency from one band to another is NOT possible.
- Always change frequency flag when frequency is changed. The frequency flag is to be attached to the top of antenna and the channel designation to the base. (See Drawing)
- It is illegal to change crystals on 72-75 MHz bands in the U.S.A. unless performed by a licensed technician.

## ▲ Antenna Frequency Flag

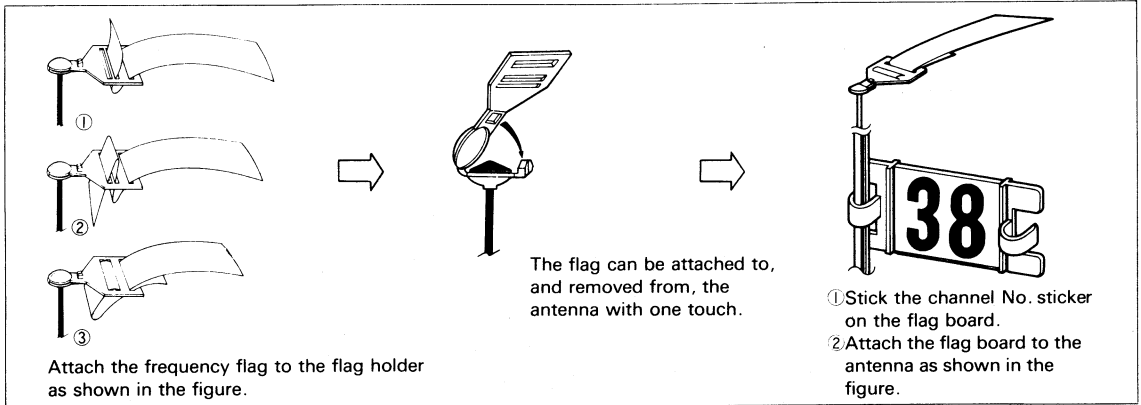

## ▲ Frequency, Channel No. , Flag Color (FOR U.S.A.)

26-27MHz-Aircraft/car/boat		72MHz-Aircraft only							
	Color								
26.995	Brown	* 72.010	11	* 72.410	31	* 72.810	51		
27.045	Red	72.030	12	72.430	32	72.830	52		
27.095	Orange	* 72.050	13	* 72.450	33	* 72.850	53		
27.145	Yellow	72.070	14	72.470	34	72.870	54		
27.195	Green	* 72.090	15	* 72.490	35	* 72.890	55		
27.255	Blue	72.110	16	* 72.510	36	72.910	56		
		* 72.130	17	* 72.530	37	* 72.930	57		
		72.150	18	72.550	38	* 72.950	58		
50/53MHz-Aircraft/car/boat-Fcc Amature		* 72.170	19	* 72.570	39	* 72.970	59		
Licence required (2 and 3 channels not		72.190	20	72.590	40	* 72.990	60		
produced on these frequencies.)		* 72.210	21	* 72.610	41				
	Channel No.	72.230	22	72.630	42				
50.800	RC00	* 72.250	23	* 72.650	43				
* 50.820	RC01	72.270	24	72.670	44				
50.840	RC02	* 72.290	25	* 72.690	45				
* 50.860	RC03	72.310	26	72.710	46				
50.880	RC04	* 72.330	27	* 72.730	47				
* 50.900	RC05	72.350	28	72.750	48				
50.920	RC06	* 72.370	29	* 72.770	49				
* 50.940	RC07	72.390	30	72.790	50				
50.960	RC08								
* 50.980	RC09								
	Color								
53.100	Black-Brown	* 75.410	61	* 75.610	71	* 75.810	81		
53.200	Black-Red	75.430	62	75.630	72	75.830	82		
53.300	Black-Orange	* 75.450	63	* 75.650	73	* 75.850	83		
53.400	Black-Yellow	75.470	64	75.670	74	75.870	84		
53.500	Black-Green	* 75.490	65	* 75.690	75	* 75.890	85		
53.600	Black-Blue	75.510	66	75.710	76	75.910	86		
53.700	Black-Violet	* 75.530	67	* 75.730	77	* 75.930	87		
53.800	Black-Gray	75.550	68	75.750	78	75.950	88		
		* 75.570	69	* 75.770	79	* 75.970	89		
		75.590	70	75.790	80	75.990	90		

\* Effective JAN 1. 1991

## CONVERSION TO NICAD SYSTEM FP-2PBKA ONLY (OPTIONAL)

To use a nicad battery with this set, modify the set with the optional FBPK-18 (2PBKA nicad battery conversion set).

- (1) Remove the battery cover as shown in this figure. Then install the transmitter NT-8R nicad battery and install the battery cover.

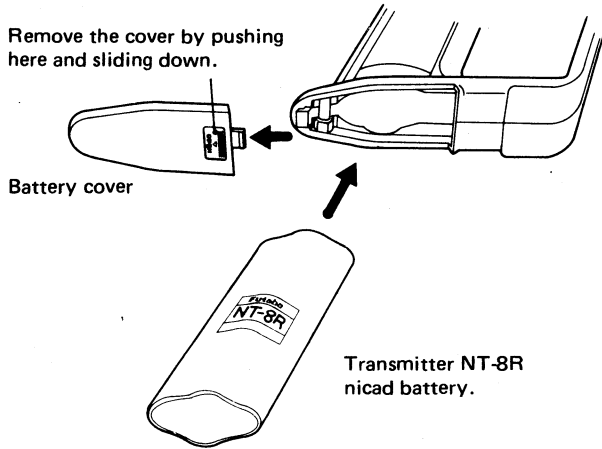

### (2) Charging and how to use

- (a) Connect the power plug of the FBC-8B (4) battery charger to the transmitter charging connector. Connect the 3PC red male connector to the receiver and servo NR-4QB nicad battery. Plug the battery charger into a 120 VAC outlet as shown in this figure.
- (b) Normally recharge the battery for about 15 hours. If the battery has not been used for some time or is new, discharge and recharge it 2 or 3 times before use.
- (c) If the battery is left discharged for a long time, its capacity will decrease and the life of the battery will be shortened. After use, recharge the battery before storing it.
- (d) Always recharge the battery before use.
- (e) A fully charged battery can be used for about two hours at 10 minutes/running.

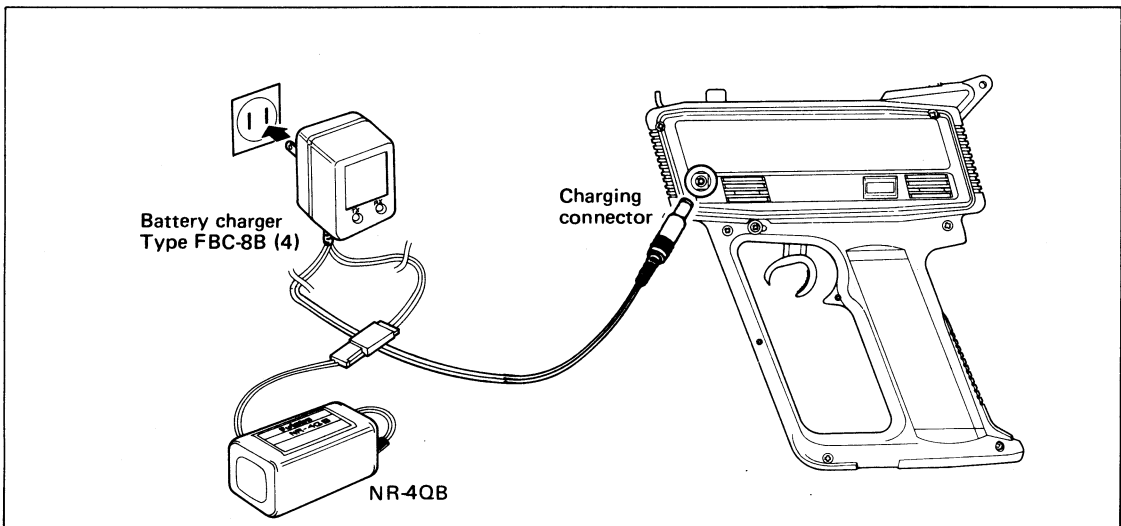

## LIMITED WARRANTY

Your new FUTABA Digital Proportional R/C System is warranted to the original purchaser for one full year from the date of purchase against defects in material and workmanship. During this period Futaba will repair or replace, at our discretion, the defective component. This warranty does not apply to any unit which has been improperly installed, handled, abused, damaged in a crash, nor to any unit which has been repaired or altered by unauthorized agencies. Under no circumstances will the buyer be entitled to consequential or incidental damages. This Limited Warranty gives you specific legal rights; you may also have other rights which vary from state to state. Batteries and plastic housings are not covered by warranty.

## REPAIR SERVICE

- When requesting repair of trouble that has occurred suddenly from long use, describe the trouble symptoms in as much detail as possible. This will facilitate detection of the trouble point and shorten the repair period greatly.
- Defects caused by faulty materials or workmanship will be corrected free of charge. Refer to warranty statement for details.

FP-S148

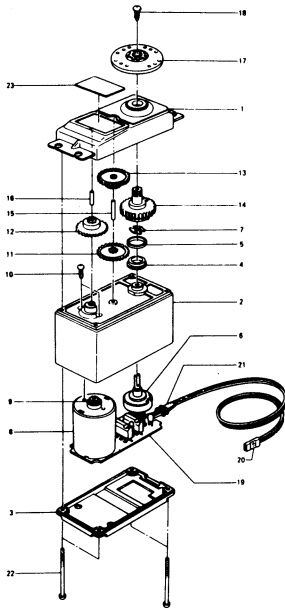

No.	Part name	Part No.	No.	Part name	Part No.
1.	upper case	FCS-48	13.	3rd gear	FGS-48
2.	Middle case	FCS-48	14.	Final gear	FGS-48
3.	Bottom case	FCS-48	15.	Intermediate shaft	S02495
4.	Metal bearing	S04137	16.	2nd shaft	S02494
5.	Metal bearing	S04136	17.	Servo horn D	FSH-6W
6.	Potentiometer	I39668	18.	Binding head tapping screw 2.6x8	FSH-41
7.	Potentiometer drive plate	S02753	19.	Printed wiring board S148	AS1157
8.	Motor	S91239	20.	S148 3PB-WRB300G	AT2453
9.	Motor pinion	S02461	21.	w gum bush	S90045
10.	Screw	J50002	22.	pan head truss screw	S50360
11.	1st gear	FGS-48	23.	Nameplate S148	S60099
12.	2nd gear	FGS-48			

FP-S9601

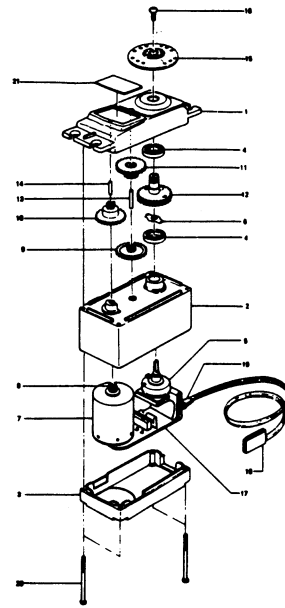

No.	Part name	Part No.	No.	Part name	Part No.
1.	Upper case	FCS-35	12.	Final gear	FGS-9601
2.	Middle case	FCS-35	13.	Intermediate shaft	S04285
3.	Bottom case	FCS-35	14.	2nd shaft	S02767
4.	Ball bearing	S04130	15.	Servo horn D	FSH-6W
5.	Potentiometer	I39995	16.	Horn mounting screw	FSH-41
6.	VR drive plate	S05626	17.	Printed wiring board	AS1317
7.	Coreless motor	S91260	18.	3PB-WRB-170	AL0705
8.	Motor pinion	S05532	19.	Lead wire packing	S90045
9.	1st gear	FGS-9601	20.	Case mounting screw	J40070
10.	2nd gear	FGS-9601	21.	Nameplate	S60193
11.	3rd gear	FGS-9601			

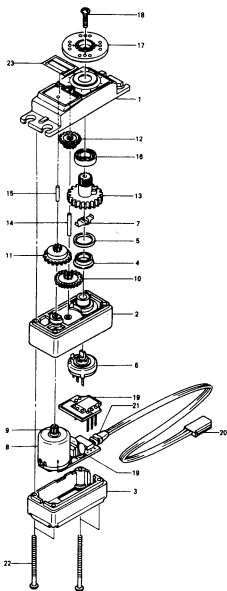

No.	Part name	Part No.	No.	Part name	Part No.
1.	Upper case	S05820	14.	Intermediate shaft	S02480
2.	Middle case	S05842	15.	2nd shaft	S02481
3.	Bottom case	S05843	16.	Ball bearing	S04130
4.	Metal bearing	S04137	17.	Servo horn D	S01239
5.	Metal bearing	S04136	18.	Horn mounting screw	J55178
6.	Potentiometer	139668	19.	S132HA Printed wiring board	AMS100048
7.	VR drive plate	S05626	20.	S132H 3PB-WRB-300	AT2238
8.	Motor	S91249	21.	Lead wire packing	S90045
9.	Motor pinion	S02788	22.	Case mounting screw	J50083
10.	1st gear	S02787	23.	S132H Name-plate	S60128
11.	2nd gear	S03250			
12.	3rd gear	S03252			
13.	Final gear	S03254			

**▲ SPLINED HORNS**

This horn permits shifting of the servo neutral position at the servo horn. Setting and shifting the neutral position.

**a) Angle divisions**

- 1) The splined horn has 25 segments. The amount of change per segment is;  $360 \div 25 = 14.4^\circ$
- 2) The minimum adjustable angle is determined by the number of arms or number of the holes. For four arms, the minimum adjustable angle is:

$$360^\circ \div \frac{(25 \times 4)}{\text{Number of divisions}} = 3.6^\circ$$

**b) Effect**

To shift the holes center line to the right (clockwise) relative to baseline A, shift arm 2 to the position of arm 1 and set it to the position closest to baseline A.

[Example] For a four arm horn, the angular shift per segment is  $14.4^\circ$ . The shift to the right is  $90^\circ - (14.4 \times 6) = 3.6^\circ$

To shift by the same angle in the opposite direction, use the opposite arm number.

For a six arm horn, turn the arm counterclockwise and set arm 2 to the position of arm 1. The adjustable angle is  $60^\circ - (14.4 \times 4) = 2.4^\circ$ .

Arm 3 shift  $4.8^\circ$  to the right, arm 6 shifts  $2.4^\circ$  to the left, and arm 4 shifts  $7.2^\circ$  to the right and left.

**▲ WHEN VEHICLE WILL NOT BE USED**

Be sure and release the connector of running Nicd battery except when you are on the way to the starting line.

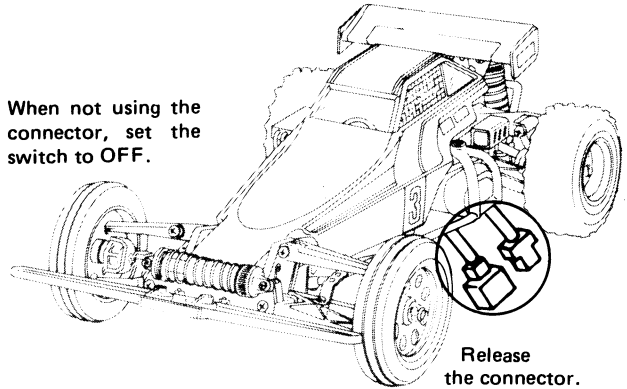

When not using the connector, set the switch to OFF.

Release the connector.

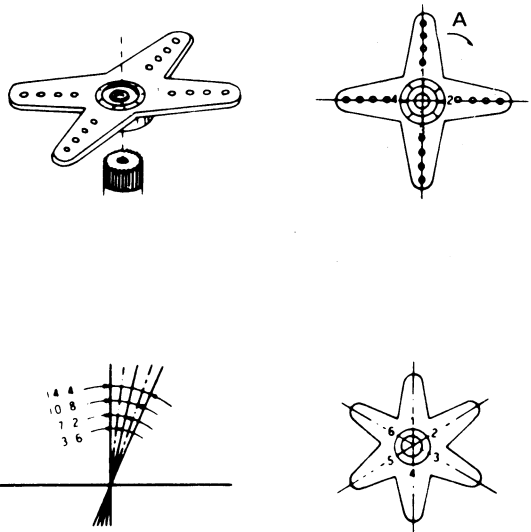

The following splined horns are optional.

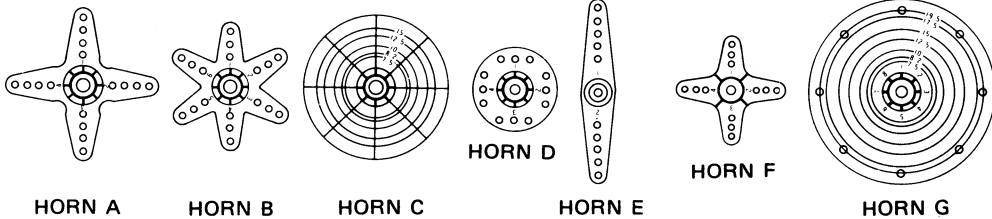

# IMPORTANT : Receiver Antenna Routing

To obtain the best possible range (car to transmitter distance) and reduce the possibility of interference, please observe these antenna routing instructions.

Failure to follow these guidelines can result in loss of control or limited range.

- 1) NEVER cut your receiver's antenna wire. Your system has been precisely tuned to the full length of the stock antenna.
- 2) Excess antenna wire should NOT be tightly coiled. To safely store the excess wire make an antenna shortener from a small piece of stiff cardboard. This will provide maximum reception and prevent tangling and breakage of the wire.
- 3) When routing the antenna wire to the antenna tube keep the wire away from battery and speed control wiring. The high power of the NiCd battery creates electrical "noise" which can cause interference.

## SNOW IS WATER

Remember that operating your FX10 on snow or in wet areas is not recommended. Melted snow becomes water which will damage or short out your system's electronics.

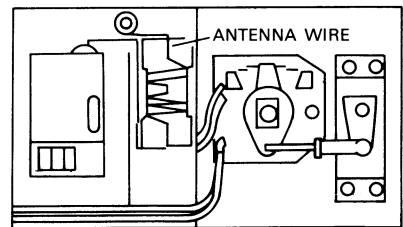
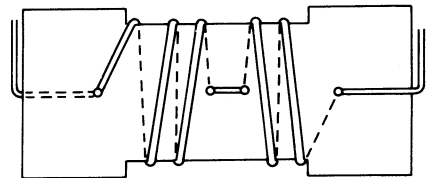
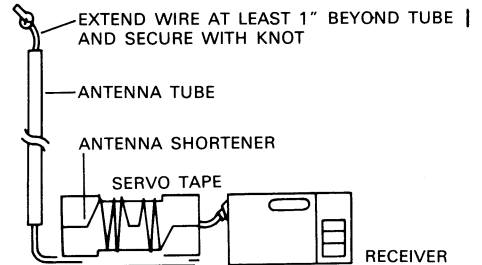

KEEP ANTENNA WIRE AWAY FROM POWER WIRES



## FUTABA CORPORATION OF AMERICA

4 Studebaker, Irvine California 92718, U.S.A.

Phone: 714-455-9888 Telex: 23-0691227 Facsimile: 714-455-9899

## FUTABA CORPORATION

Tokyo Office: INAGAKI BLDG., 3F 1-21-3, Kanda sudacho, Chiyoda-ku, Tokyo, Japan.

Phone: (03)3255-6811 Facsimile: (03)3255-6880