

CHI

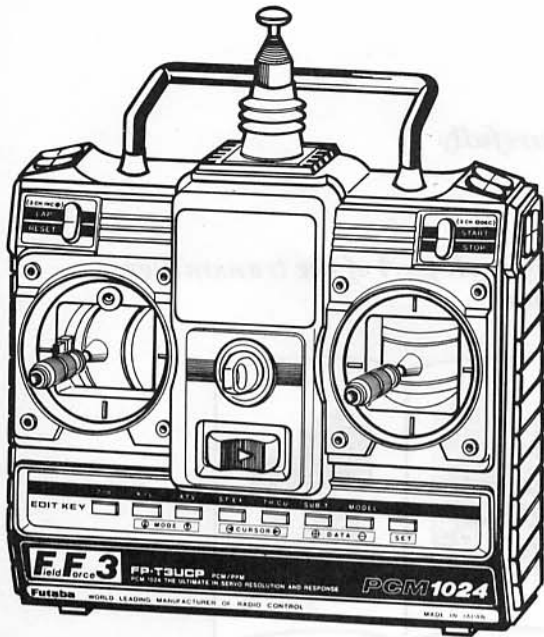

Futaba®

DIGITAL PROPORTIONAL
RADIO CONTROL

FP-3UCP PCM 1024 SYSTEM

INSTRUCTION MANUAL

FP-3UCP

FOR CARS
PCM 3 CHANNELS EXPERT



FUTABA CORPORATION
FUTABA CORPORATION OF AMERICA

Thank you for purchasing a Futaba digital proportional radio control set. Please read this manual carefully before using your set.

The last page of this manual is a double foldout showing the name of each part of the transmitter. Please open it when reading this manual.

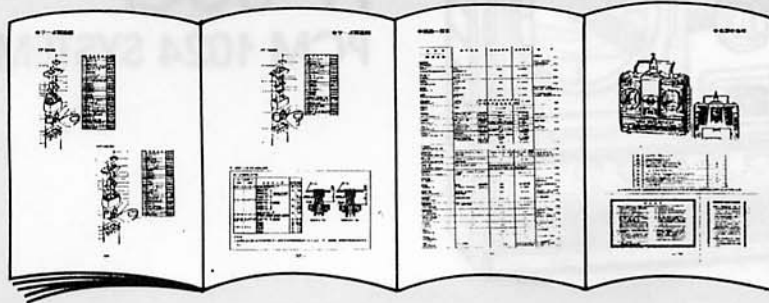





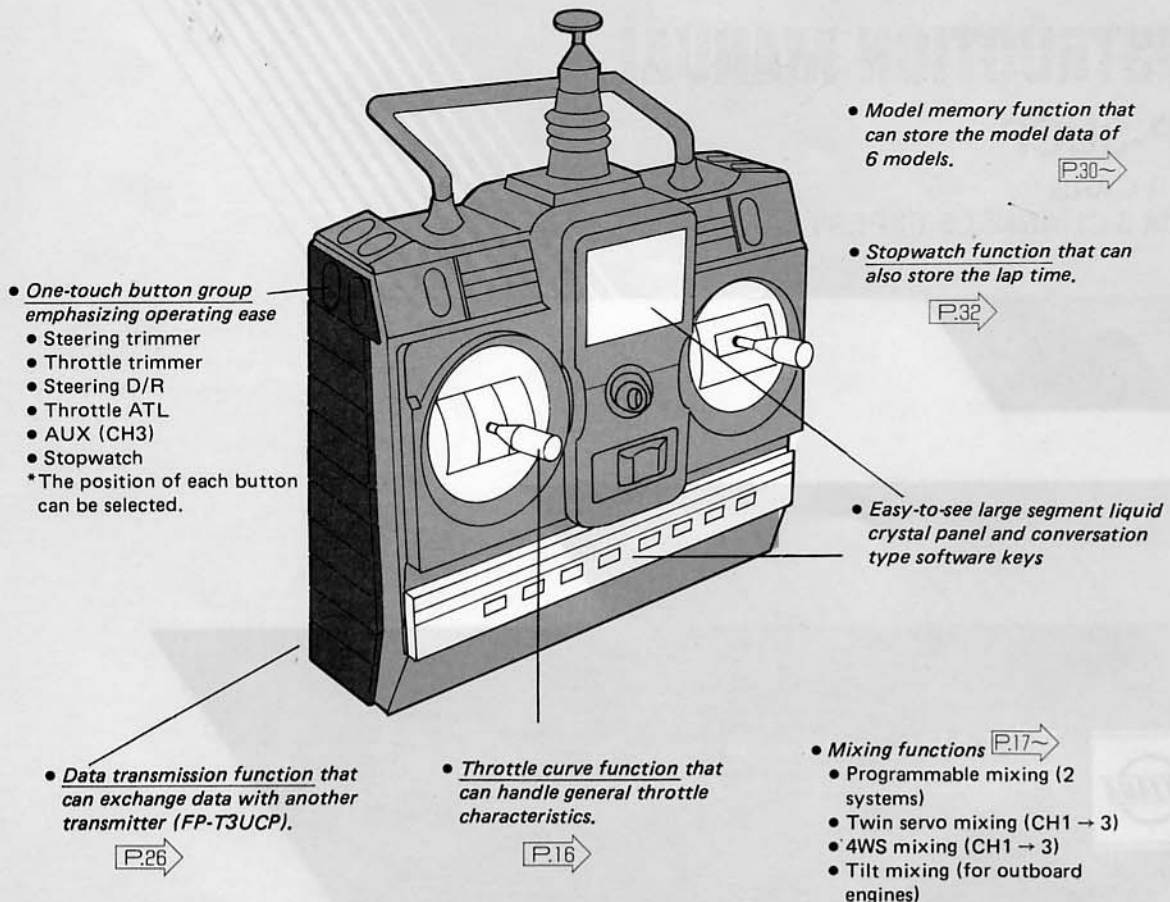



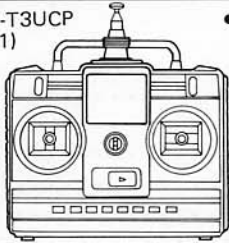

● FEATURES

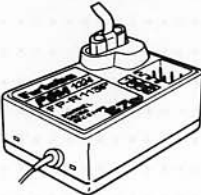
- High resolution and fast response PCM 1024 system 3 channels system

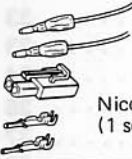

SET CONTENTS AND RATINGS	2
RECOMMENDED USE EXAMPLES	3
BEFORE USE	4
EDIT KEY FUNCTIONS	6
BASIC SETTINGS	8
FUNCTIONS AND DATA SETTING	12
INITIAL DISPLAY	12
MODEL NO. DISPLAY	13
ATV	13
SUB TRIM	14
EXP	14
D/R	15
ATL	15
THROTTLE CURVE	16
REVERSE	17
TWIN SERVO MIXING	17
4WS MIXING	18
TILT MIXING	19
PROGRAMMABLE MIXING 1	20
PROGRAMMABLE MIXING 2	21
D/R, ATL, AND CH3 ONE-TOUCH BUTTON STEP AMOUNT ADJUSTMENT	22
ONE-TOUCH TRIM STEP AMOUNT ADJUSTMENT	23
ONE-TOUCH BUTTON POSITION SETTING	24
THROTTLE NEUTRAL POSITION SETTING	25
DATA TRANSMISSION FUNCTION	26
FAIL SAFE FUNCTION	27
BATTERY FAIL SAFE FUNCTION	28
MODULATION	28
BUZZER VOLUME SWITCHING	29
SERVO OPERATION DISPLAY	29
ALL CLEAR FUNCTION	30
MODEL COPY FUNCTION	30
MODEL SELECT FUNCTION	31
MODEL RECOVERY FUNCTION	31
STOPWATCH FUNCTION	32
OTHER FUNCTIONS	33
DSC FUNCTION	33
STICK LEVER TENSION ADJUSTMENT	33
NON-SLIP ADJUSTABLE LEVER HEAD ADJUSTMENT	33
MECHANICAL ATL FUNCTION	33
USING THE ACCESSORIES	34
FP-T3UCP DATA SHEET	36
FUNCTIONS DATA	37
SERVO EXPLODED VIEW	38
NOMENCLATURE	39
SERVO HORN MOUNTING SCREW PRECAUTIONS	40

● SET CONTENTS AND RATINGS

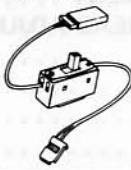
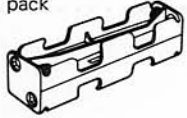
Set contents	FP-3UCP for motor racing	FP-3UCP for motor buggy	FP-3UCP for engine racing	FP-3UCP for engine buggy	FP-3UCP for engine buggy	Rating																				
Transmitter and RF module	<ul style="list-style-type: none"> FP-T3UCP (X1) 		<ul style="list-style-type: none"> FP-TP-FM (X1) 27, 40, 41 or 75MHz band 			<p>Stick type, 3 channels transmitter Transmitting frequency: 27, 40, 41 or 75MHz band Modulation: FM-PCM/PPM selectable Power requirement: 8 penlight batteries (12V) or 9.6V Nicd battery pack Current drain: 200mA</p>																				
	<ul style="list-style-type: none"> FP-R113iP (x1) 					<p>Miniature 3 channels PCM receiver Receiving frequency: 27, 40, 41 or 75MHz band Intermediate frequency: 455kHz Power requirement: 4.8V or 6V Current drain: 16mA Dimensions: 42.7x28.7x16.0mm Weight: 21g Receiving range: 300m on the ground (range differs with the surroundings) Antenna length: 50cm</p>																				
Servo	<ul style="list-style-type: none"> FP-S9601 (X1) 	<ul style="list-style-type: none"> FP-S9401 (X1) 	<ul style="list-style-type: none"> FP-S9302 (X1) 			<p>Control system: +pulse width control Operating angle: One side 45° or greater (including trim) Power requirement: 4.8V or 6V (shared with receiver) Current drain: 12mA (S9601, S9401) and 15mA (S9302) at 6V (at idle)</p> <table border="1"> <thead> <tr> <th></th> <th>Output torque</th> <th>Operating speed</th> <th>Dimensions</th> <th>Weight</th> </tr> </thead> <tbody> <tr> <td>FP-S9601</td> <td>2.4kg·cm</td> <td>0.15S/60°</td> <td>31x16x30.2</td> <td>31g</td> </tr> <tr> <td>FP-S9401</td> <td>3.2kg·cm</td> <td>0.16S/60°</td> <td>40.5x20x35.5</td> <td>50g</td> </tr> <tr> <td>FP-S9302</td> <td>7.2kg·cm</td> <td>0.19S/60°</td> <td>40.5x20x39.5</td> <td>64.5g</td> </tr> </tbody> </table>		Output torque	Operating speed	Dimensions	Weight	FP-S9601	2.4kg·cm	0.15S/60°	31x16x30.2	31g	FP-S9401	3.2kg·cm	0.16S/60°	40.5x20x35.5	50g	FP-S9302	7.2kg·cm	0.19S/60°	40.5x20x39.5	64.5g
		Output torque	Operating speed	Dimensions	Weight																					
FP-S9601	2.4kg·cm	0.15S/60°	31x16x30.2	31g																						
FP-S9401	3.2kg·cm	0.16S/60°	40.5x20x35.5	50g																						
FP-S9302	7.2kg·cm	0.19S/60°	40.5x20x39.5	64.5g																						
Throttle	/		<ul style="list-style-type: none"> FP-S9401 (X1) 	<ul style="list-style-type: none"> FP-S9302 (X1) 																						
FET amp			<ul style="list-style-type: none"> FP-MC116 (X1) 				<p>Operating system: Forward only w/electronic brake Power requirement: 6N-1200 or 7N-1200 Nicd battery pack Regulator output: 6V/2A (MAX) Current drain (8 minutes rating) 35A FET ratings: Maximum continuous current 210A, Maximum instantaneous current 1260A Loss resistance: 0.0035Ω (FET rating) Dimensions: 38.5x40.3x15.5 (excluding cords) Weight: 42g</p>																			
Accessories	<ul style="list-style-type: none"> Penlight battery (X8) 		<ul style="list-style-type: none"> Motor cord (x2) 		<ul style="list-style-type: none"> Nicd connector (1 set) 	<ul style="list-style-type: none"> Receiver switch SSW-GS (X1) 																				
	<ul style="list-style-type: none"> Transmitter battery holder 8P-BH or Nicd battery pack NT-8LP 		<ul style="list-style-type: none"> Servo horn Frequency flag Stick adapter 																							

*Specifications are subject to change without notice.

● RECOMMENDED USE EXAMPLE

	Motor racing	Motor buggy	Engine racing	Engine buggy
Model	<p>Steering Motor (4WS rear control)</p>		<p>Steering Brake Throttle (Needle control)</p>	
Steering servos	<ul style="list-style-type: none"> FP-S9601 	<ul style="list-style-type: none"> FP-S9401 	<ul style="list-style-type: none"> FP-S9302, FP-S9401 or FP-S9301 	<ul style="list-style-type: none"> FP-S9302 or FP-S3302
Throttle servo or motor control	<ul style="list-style-type: none"> FP-MC116 		<ul style="list-style-type: none"> FP-S9401, FP-S9301 or FP-S9302 	
AUX (CH3) servos (option)			<ul style="list-style-type: none"> Brake servo addition FP-S9301 Needle control servo addition FP-S9401 Programmable mixing function 	<ul style="list-style-type: none"> Twin servo function FP-S9301 or FP-S9401 as steering and AUX servo *Use the same kind of servo as twin servos. (Y harness cord does not have to be used with steering)
Transmitter battery	<ul style="list-style-type: none"> Penlight battery (X8) 		or <ul style="list-style-type: none"> Nicd battery pack NT-8LP 9.6V-500mA 	
Receiver battery	(Shared with drive power battery)		<ul style="list-style-type: none"> NR-5PB (sold separately) 6V/450mA or NR-4NB (sold separately) 4.8V 700mA 	
DSC cord	<ul style="list-style-type: none"> DSC cord (sold separately) (6 pin DIN) 	However, for engine cars, a Y harness cord is also necessary.		<ul style="list-style-type: none"> Y harness cord (sold separately)
Data transmission function cord	<ul style="list-style-type: none"> 6 pin Trainer cord (sold separately) 			
Battery charger				

● BEFORE USE RECOMMENDED

■ Loading the transmitter battery (8 penlight batteries)

1 Load the batteries into the holder.

Be careful of the polarity.

The polarity is marked on the battery holder.

1. Penlight battery (x8)

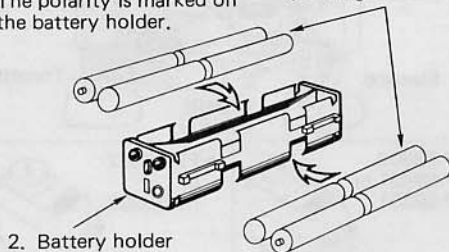

2. Battery holder

2 Set the holder into the transmitter.

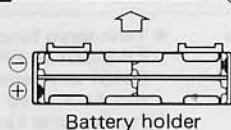
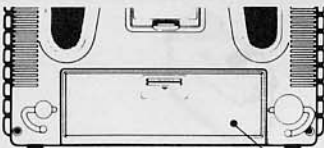

Battery holder

Slide the battery cover in the OPEN direction and remove the cover.

■ RF module

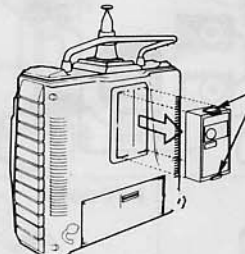

Pull the RF module while pressing these tabs to the inside.

*It is normal for the module to warm up a little in operation.

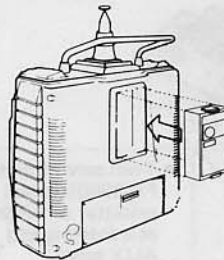

Insert the RF module into the transmitter. Push in the module, while being careful not to bend the pins, until the tabs at both sides lock into place with a "click".

*Use the special FP-TP-FM RF modules for the FP-T3UCP. Other RF modules cannot be used.

■ Options (Sold Separately)

When using an Nicd battery pack

- Use the NT-8LP Nicd battery pack.
- Use the FBC series charger as the charger.
- The charging time is 15 hours.

However, when the battery was not used for some time, charge and discharge it 2–3 times. Otherwise, the battery will not be charged even after the specified charging time (15 hours).

■ Transmitter modulation mode setting at the factory

The transmitter modulation mode (PCM/PPM mode) is switched by data setting. (For the setting method, see page 00.) The transmitter modulation mode is set at the factory as follows:

FP-T3UCP PCM mode

In this case, only FP-R113ip can be used as the receiver.

*When using a Futaba FM receiver sold separately, set the transmitter modulation mode to the PPM mode.

Recommended receiver FP-R103F (3 channels FM receiver)

In this case, the fail safe and battery fail safe functions cannot be used.

■ RECEIVER AND SERVO CONNECTIONS

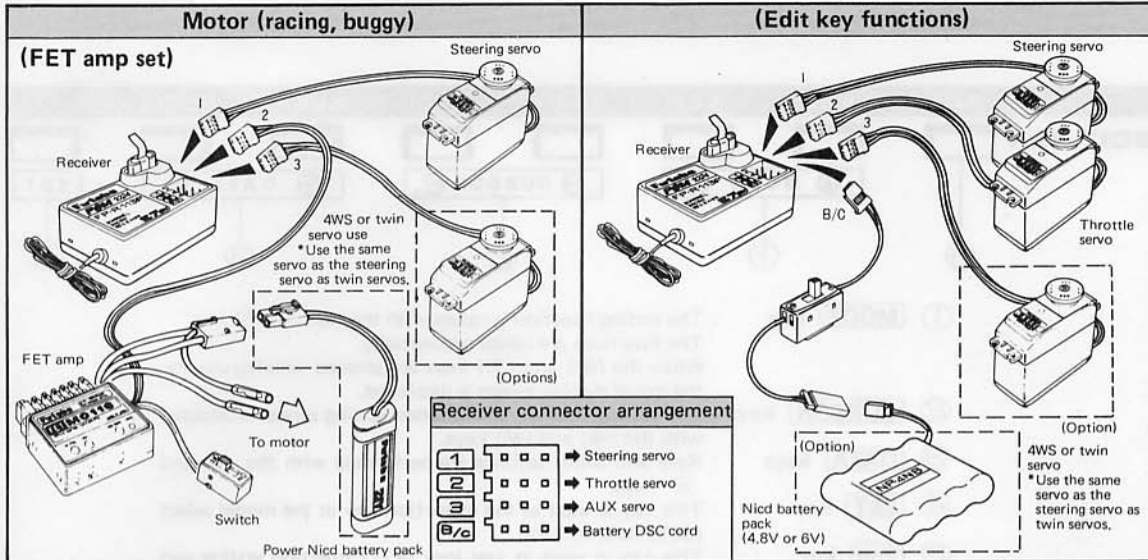

■ PRECAUTIONS

- Operate each servo horn over its full stroke and check that the pushrod does not bind or is not too loose. Unreasonable force applied to the servo horn will adversely affect the servo and drain the battery quickly. Be especially careful when using 8.4V.
- Make the travel of each control mechanism somewhat larger than the full stroke (including trim) of the servo horn. Adjust the servo horns so that they move smoothly even when the trim lever and stick are operated simultaneously in the same direction.
- Be alert for noise. Solder a noise killing capacitor to the running motor. Otherwise the receiving range may be shortened or there may be numerous dead points. If vibration causes metal parts to touch, noise will be produced and the receiver and servos may operate erroneously. We recommend the use of noiseless parts.
- Do not bundle the motor lead wire with the lead wire to other receivers.
- Just because the receiver antenna may seem long, do not cut it off or fold it back on itself. The receiving range will be shortened.

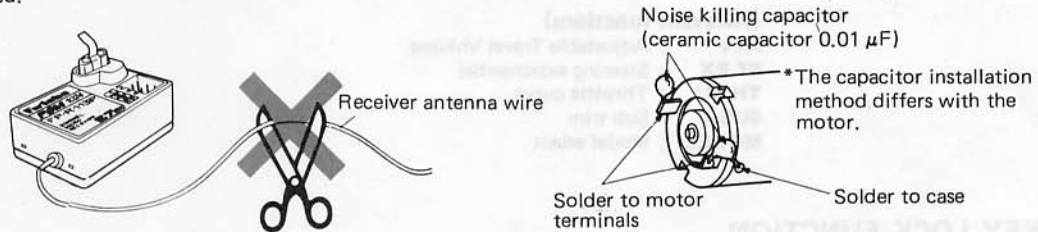

- When using a commercial motor checker, always disconnect the connector between the FET amp and the motor. If it is not disconnected, the amp may be destroyed.
- If the FET fins (metal part) of the FET amp touch an aluminum, carbon, or other chassis that passes electricity, the FET may be destroyed. When installing the FET amp, be sure that it does not touch such materials.
- A spare horn is provided. Use it as required.
- Use double-side adhesive tape so that the receiver is not directly exposed to vibration. Also, install the receiver so that it does not directly touch the frame or other parts and does not move.
- When using the receiver on a boat or where it may be splashed with mud and water, place it in a plastic bag and wrap a rubber band around the open end of the bag. After use, remove the receiver from the bag to prevent condensation.
- After mounting is complete, recheck each part, then check the transmitting range by making the transmitter antenna as short as possible and extending the receiver antenna fully and operating the set from a distance of 20m to 30m. The movement of each servo should follow the movement of the transmitter sticks. At this time, place the vehicle on a stand, etc. so that it does not move.
- The crystal can be changed from the outside of the receiver case. Always use a Futaba transmitter and receiver crystal pair as the replacement crystals.

● EDIT KEY

(Explanation of Edit Key Functions)

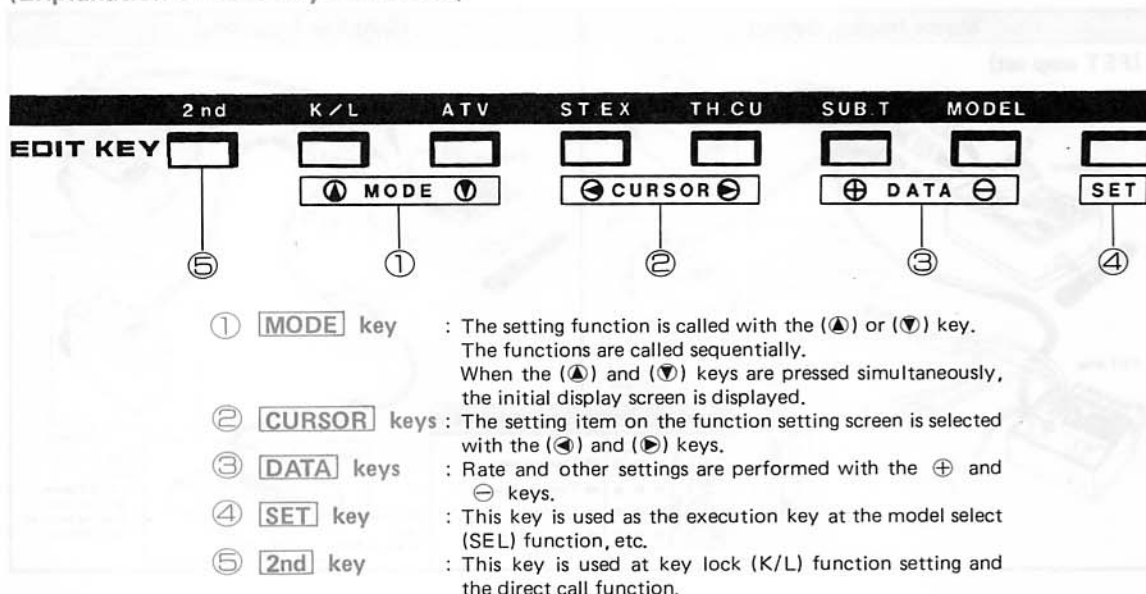

FUNCTION CALL

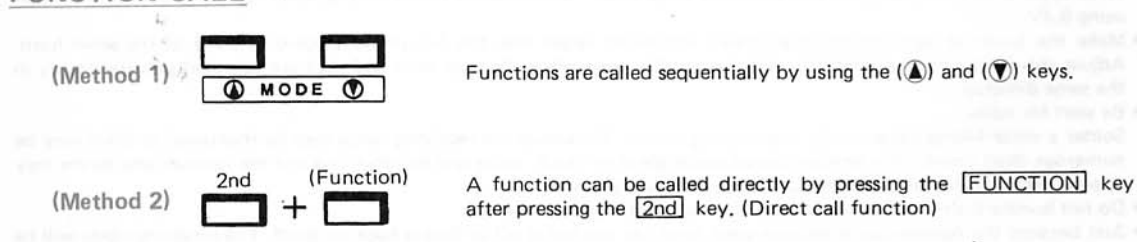

(Relevant functions)

- ATV** : Adjustable Travel Volume
- ST.EX** : Steering exponential
- TH.CU** : Throttle curve
- SUB.T** : Sub trim
- MODEL** : Model select

KEY LOCK FUNCTION

Operation, setting, etc. by edit keys can be disabled.
(The display screen of the function effective when key lock was executed is held.)

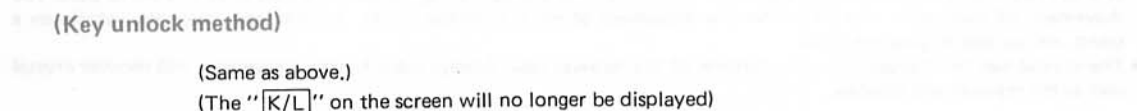
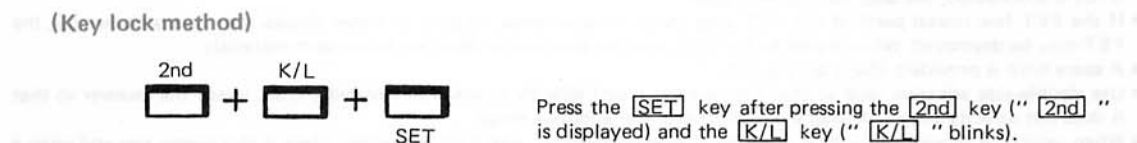

Returning to initial display
 Press the [MODE] keys and (▲) and (▼) keys simultaneously.

ORDER OF FUNCTIONS

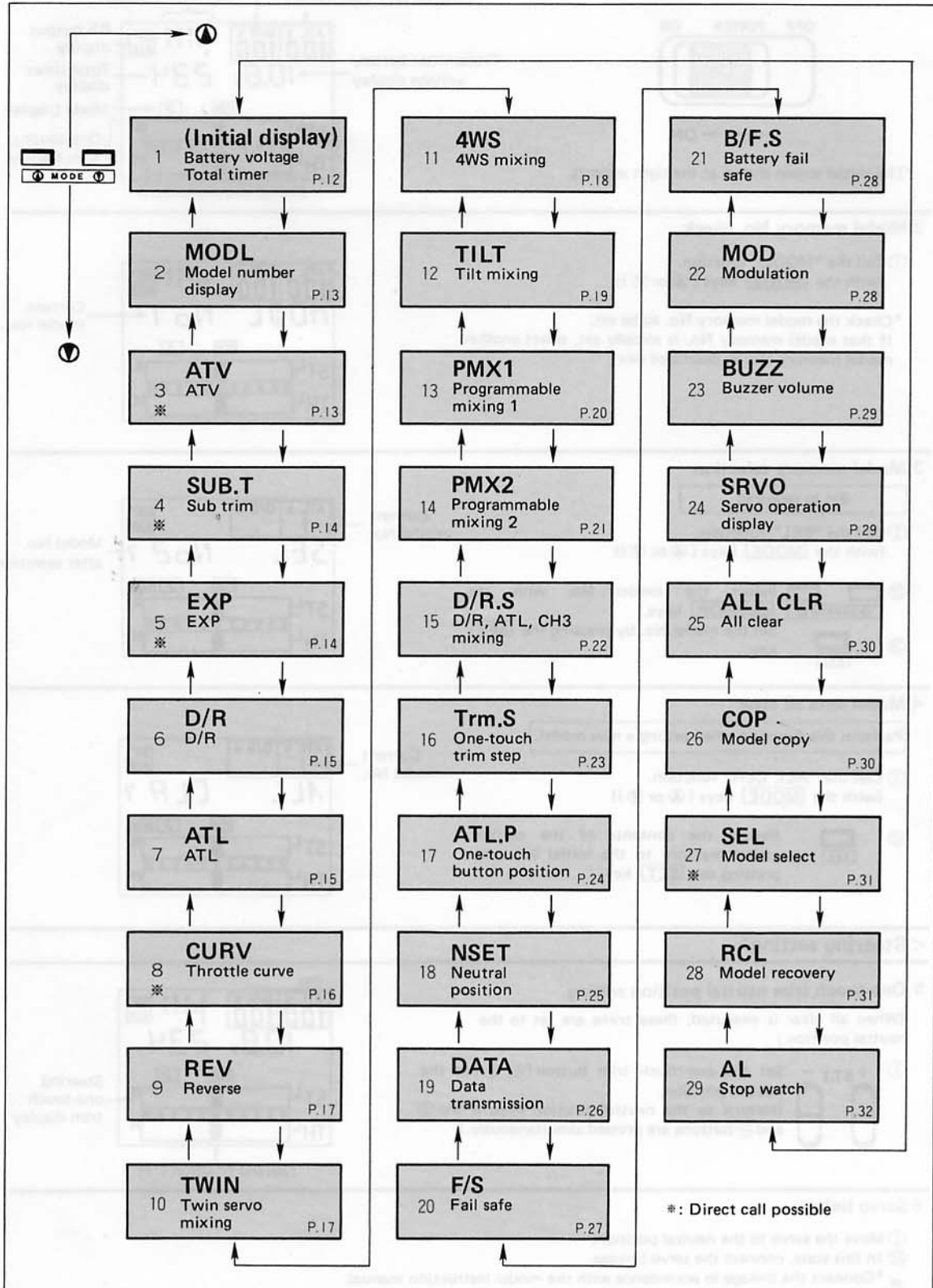

● BASIC SETTINGS

(Function selection)
 ① MODE ② can be called with the
 [MODE] keys (▲, ▼)

When using the set for the first time or when resetting the model, proceed as described below. Effective setting is performed.

For a detailed description of the setting method, see the "FUNCTIONS AND DATA SETTING" section (page 12).

1 Power switch ON

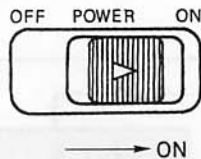

*The initial screen shown at the right appears.

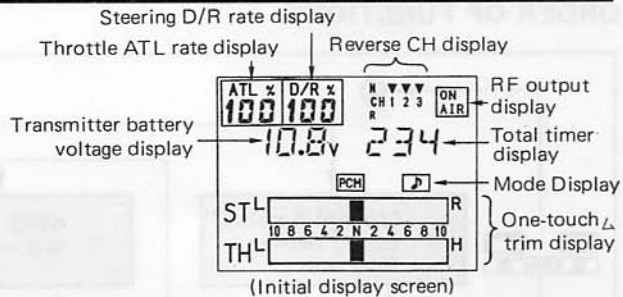

2 Model memory No. check

- Call the "MODL" function.
(with the [MODE] keys (▲ or ▼))

*Check the model memory No. to be set.
 If that model memory No. is already set, select another model memory No. as described next.

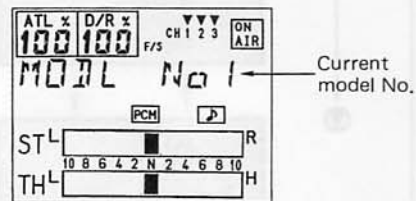

3 Model memory selection

Set as required.

- Call the "SEL" function.
(with the [MODE] keys (▲ or ▼))
- Select the model No. with the [CURSOR] keys.
- Set the model No. by pressing the [SET] key.

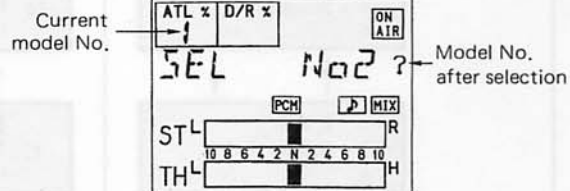

4 Model data all clear

Perform this function when setting a new model.

- Call the "ALL CLR" function.
(with the [MODE] keys (▲ or ▼))
- Return the contents of the current model memory to the initial value by pressing the [SET] key.

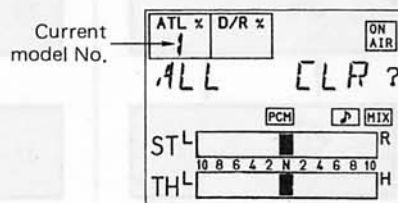

< Steering setting >

5 One-touch trim neutral position setting

(When all clear is executed, these trims are set to the neutral position.)

- Set the one-touch trim button (⊕, ⊖) to the neutral position.
(Return to the neutral position even if the ⊕ and ⊖ buttons are pressed simultaneously.)

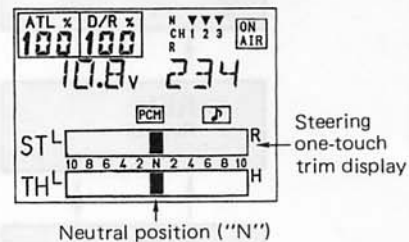

6 Servo linkage

- Move the servo to the neutral position.
 - In this state, connect the servo linkage.
- ※ *Connect the linkage in accordance with the model instruction manual.

● BASIC SETTINGS

(Function selection)
 (MODE) can be called with the
 (MODE) keys (▲, ▼)

7 Adjust the stick and linkage operating directions.

When the operating directions are reversed, perform the following setting:

- ① Call the "REV" function.
(with the (MODE) keys (▲ or ▼))
- ② Select CH1 with the (CURSOR) keys.
- ③ Set the operating direction with the (DATA) keys.

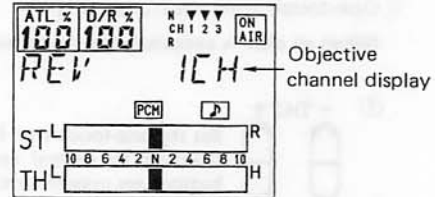
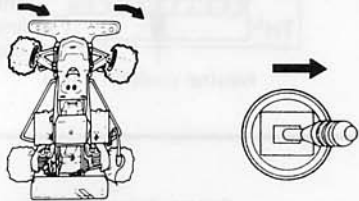

8 Adjust the linkage neutral position.

First, in the 0% sub trim state, adjust the neutral position of the linkage itself, then fine adjust it by sub trim.

- ① Call the "SUB.T" function.
(with the (MODE) keys (▲ or ▼))
- ② Select CH1 with the (CURSOR) keys.
- ③ Fine adjust the neutral position with the (DATA) keys.

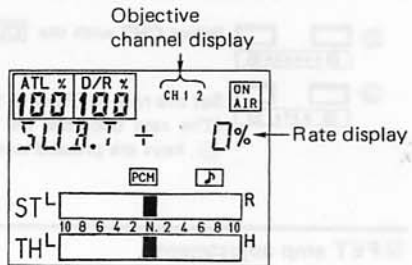
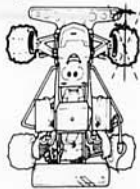

9 D/R, ATV, and EXP function setting (Initial value)

First set these functions to the initial value.
(When all clear is executed, these functions are set to the initial value.)

- (D/R)
- ① Call the "D/R" function.
(with the (MODE) keys (▲ or ▼))
 - ② Set the rate to 100% with the (DATA) keys.
(The rate becomes 100% even when the + and - keys are pressed simultaneously.)

Setting possible with the single push of a button

- (ATV)
- ① Call the "ATV" function.
(with the (MODE) keys (▲ or ▼))
 - ② Select CH1 with the (CURSOR) keys.
 - ③ Set the rate to 100% with the (DATA) keys.
(The rate becomes 100% even when the + and - keys are pressed simultaneously.)

At this time, the rate is set for both directions of the stick.

- (EXP)
- ① Call the "EXP" function.
(with the (MODE) keys (▲ or ▼))
 - ② Set the rate to 0% with the (DATA) keys.
(The rate becomes 0% even when the + and - keys are pressed simultaneously.)

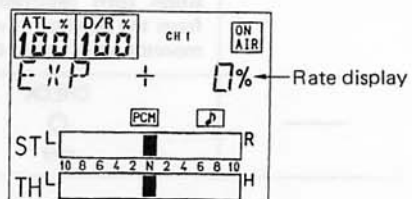
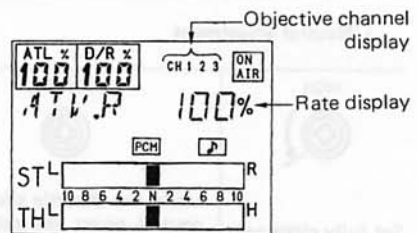
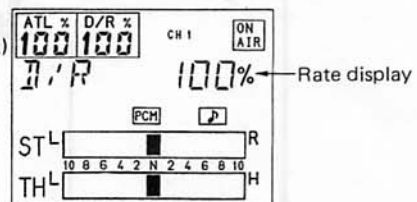

● BASIC SETTING

(Function selection)
 [MODE] can be called with the [MODE] keys (▲, ▼)

< Throttle setting > 10 ~ 13

10 One-touch trim neutral setting

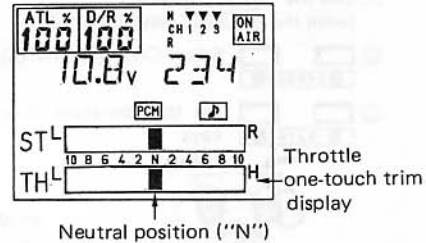

(When all clear is executed, one-touch trim is set to neutral.)

- ① - TH.T+
 Set the one-touch trim (⊕, ⊖) to neutral.
 (Returns to neutral even when the ⊕ and ⊖ buttons are pressed simultaneously.)



11 Set sub trim to 0%.

(When all clear is executed, the rate becomes 0%.)



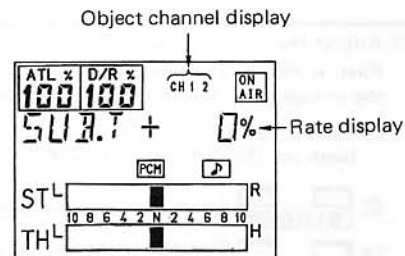



- ① Call the "SUB. T" function.
 (with the [MODE] keys (▲ or ▼))
- ②  Select CH2 with the [CURSOR] keys.
- ③  Set the rate to 0% with the [DATA] keys.
 (The rate becomes 0% even when the ⊕ and ⊖ keys are pressed simultaneously.)

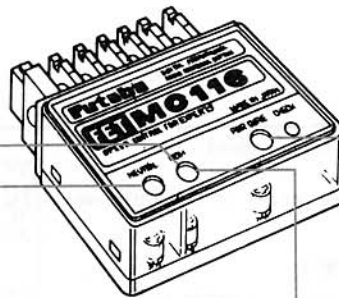

12 FET amp adjustment

(When FET amp MC116 used)



1 Neutral adjustment		2 High point adjustment		3 Power curve adjustment	
HIGH 	NEUTRAL 	HIGH 	HIGH 	PWR. CURVE Mild  Quick	PWR. CURVE Mild  Quick
Set fully clockwise.	Make the throttle stick to the neutral point neutral and set the neutral trimmer to the position (off) returned a little from the position at which the monitor lamp comes on.	Set the throttle stick to a little before maximum speed and set the high point trimmer so that the monitor lamp changes from green to red.	Set the throttle stick to a little before maximum speed and set the high point trimmer so that the monitor lamp changes from green to red.	Adjust the power curve while the vehicle is running.	Adjust the power curve while the vehicle is running.
—	CHECK ○ Off	CHECK ☀ On (red)	CHECK ☀ On (red)	—	—

● BASIC SETTING

(Function selection)
 ▲ MODE ▼ can be called with the
 [MODE] keys (▲, ▼)

13 ATL, ATV, and throttle curve function setting

First set these functions to their initial value.
 (When all clear is executed, these functions are set to their initial value.)

- (ATL) ① Call the "ATL" function.
 (with the [MODE] keys (▲ or ▼))
- ② [DATA] [DATA] Set the rate to 100% with the [DATA] keys.
 (The rate becomes 100% even when the ⊕ and ⊖ keys are pressed simultaneously.)

- (ATV) ① Call the "ATV" function.
 (with the [MODE] keys (▲ or ▼))
- ② [CURSOR] [CURSOR] Select CH2 with the [CURSOR] keys.
 (The rate becomes 100% even when the ⊕ and ⊖ keys are pressed simultaneously.)
- ③ [DATA] [DATA] Set the rate to 100% with the [DATA] keys.
 (The rate is set to 100% even when the ⊕ and ⊖ keys are pressed simultaneously.)

At this time, the rate is set for both directions of the stick.

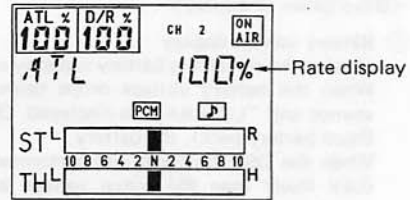

Rate display

Objective channel display

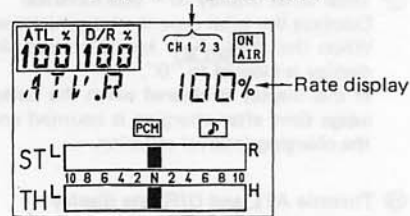

Rate display

(Throttle curve)

- ① Select the "CURV" function.
 (with the [MODE] keys (▲ or ▼))
- ② [CURSOR] [CURSOR] Select the "CURV RES?" item with the [CURSOR] keys.
- [SET] Return the throttle curve to the initial value (straight line) by pressing the [SET] key.

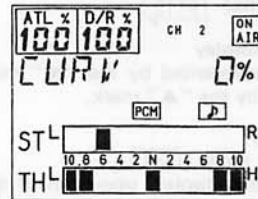

CAUTION

- Do not connect the running motor when making the settings.
- When using an FET amp, always turn off battery fail safe.

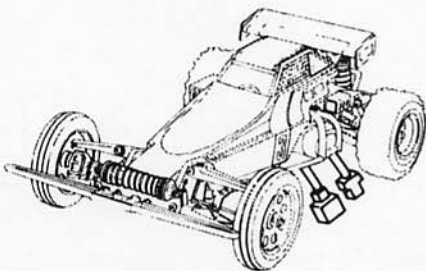

- When not running, always disconnect the Nid battery pack connector.

■ Try running the vehicle with the adjustments up to here. Then make fine adjustments.

● FUNCTIONS AND DATA SETTING METHOD

Returning to initial display
 Press the [MODE] keys and (▲) and (▼) keys simultaneously.

INITIAL DISPLAY

<Description of display>

① Battery voltage display

Used as the remaining battery capacity criterion. When the battery voltage drops below 8.5V, an alarm sounds and "LOW BAT" is displayed. Change, or recharge (Nicc battery pack), the battery. When the DSC function was performed, a voltage about 0.4V lower than the actual voltage is displayed at the power switch OFF position.

② Total timer display (0 – 999 minutes)

Displays the total time the transmitter was on. When the [DATA] key is pressed simultaneously, this display is cleared to "0". If this display is cleared when the battery is charged the usage time after charging is counted and it can be used as the charging interval criterion.

③ Throttle ATL and D/R rate display

Represents each rate. (For a description of the rate setting method, see the D/R and ATL items.) [P.15]

④ Reverse CH display

Normal is represented by the "▼" mark and reverse is represented by the "▲" mark.

⑤ Mode display

- a: Key lock mode ([K/L])
 During this display, operation of the ▲, ▼, ◀, ▶, ⊕, ⊖ and [SET] keys is not accepted and the display is fixed at the key locked screen.
- b: PCM mode ([PCM])
 Shows that the transmitter is currently operating in the PCM mode.
- c: PPM mode ([PPM])
 Shows that the transmitter is currently operating in the PPM mode.
- d: Buzzer on mode (♪)
 Shows that the buzzer function is enabled. Buzzer is displayed when an effective key is operated.
- e: Mixing on display ([MIX])
 Shows that TWIN, 4WS, TILT, PMX1, or PMX2 mixing is on.

⑥ One-touch trim display

The top row shows the steering trim position and the bottom row shows the throttle trim position.

⑦ RF output display

When radiowaves are output, "[ON AIR]" is displayed.

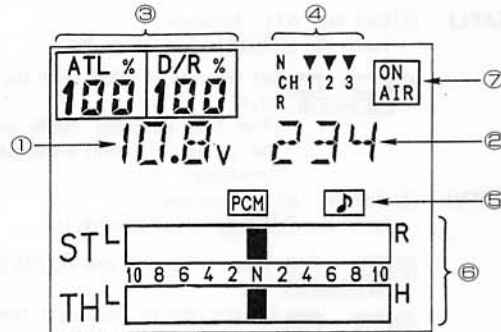

<Example>

In case of above display;

- | | |
|---------------------------|--------------------------------------|
| ① Battery voltage display | 10.8V |
| ② Total timer display | 234 minutes |
| ③ Throttle ATL | 100% |
| Steering D/R | 100% |
| ④ Reverse function | normal side (each CH) |
| ⑤ Each mode display | PCM mode
Buzzer on mode |
| ⑥ One-touch trim | Steering neutral
Throttle neutral |
| ⑦ RF output display | "ON AIR" state |

MODE To MODL

FUNCTIONS AND DATA SETTING METHOD

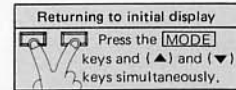

MODL Model No. display

<Description of display>

- ① **Model memory No.**
Displays the model No. currently operating.
For a description of model No. switching, see the "SEL" model select function item. (P.3)
- ② **F/S set CH**
This is displayed only when the transmitter is operating in the PCM mode. The F/S ("▲") or OFF ("▼") state for CH1 to CH3 is displayed.
In the PPM mode, nothing is displayed.
For a description of F/S setting, see the "F/S" fail safe function item. (P.27)

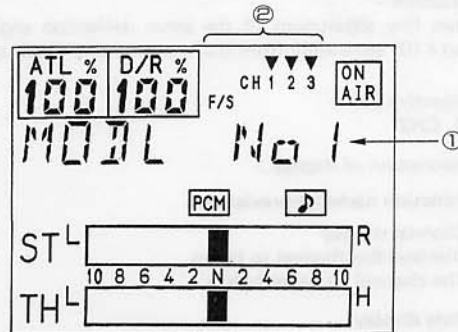

ATV Adjustable Travel Volume

Direct call

<Function>

Allows independent adjustment of the servo left and right deflection angles, centered about the stick neutral position.

<Objective CH>

CH1, CH2, CH3

<Description of display>

- ① **Function name (abbreviation)**
Displays the setting objective direction.
ATV. R: CH1 right side
ATV. L: CH1 left side
ATV. H: CH2 high side
ATV. L: CH2 low side
ATV. +: CH3 right side
ATV. -: CH3 left side

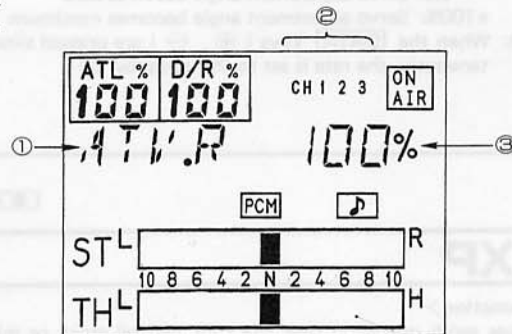

- ② **Channel display**
Displays the channel to be set. The channel to be set blinks.

- ③ **Rate display**
Displays the set ATV rate.

<Setting method>

- ① Select the channel to be set with the [CURSOR] keys (◀, ▶). (Display ②).
- ② Move the [stick] (or [switch]) of that channel in the direction to be set. (Display ①)
- ③ Set the rate with the [DATA] keys (+, -). (Display ③)
 - a: Setting range: 0% to 100%
0%: Servo deflection angle becomes zero
100%: Servo deflection angle becomes maximum
 - b: When the [DATA] keys (+, -) are pressed simultaneously, the rate is set to 100%. (Display ③)

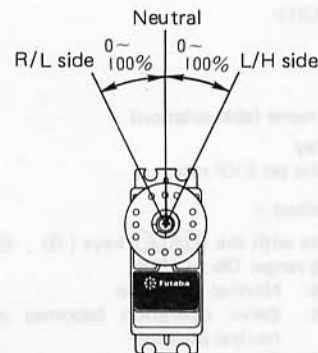

● FUNCTIONS AND DATA SETTING METHOD

Returning to initial display
 Press the [MODE] keys and (▲) and (▼) keys simultaneously.

SUB.T

Sub trim

Direct call

<Function>

Allows fine adjustment of the servo deflection angle up to about $\pm 10^\circ$ separately from the stick and one-touch trim.

<Objective CH>

CH1, CH2

<Description of display>

① Function name (abbreviation)

② Channel display

Displays the channel to be set.
The channel to be set blinks.

③ Rate display

Displays the set sub trim rate.

<Setting method>

① Select the channel to be set with the [CURSOR] keys (◀, ▶). (Display ②)

② Set the rate with the [DATA] keys (+, -). (Display ③)

a: Setting range: 0% to $\pm 100\%$

0%: Servo adjustment angle becomes zero

$\pm 100\%$: Servo adjustment angle becomes maximum

b: When the [DATA] keys (+, -) are pressed simultaneously, the rate is set to 0%. (Display ③)

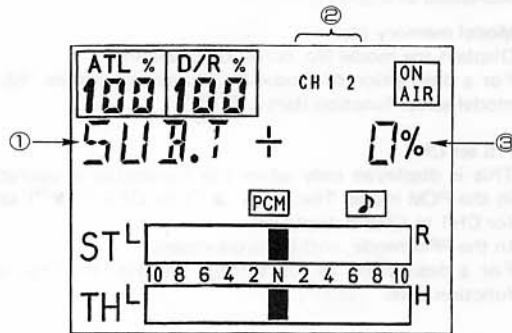

Neutral adjustment 0 - $\pm 100\%$

(about $\pm 10^\circ$)



MODE To EXP

EXP

<Function>

Makes servo operation near the stick neutral quick or mild. This has no affect on the servo deflection angle at both ends of the stick.

<Objective CH>

CH1

① Function name (abbreviation)

② Rate display

Displays the set EXP rate.

<Setting method>

① Set the rate with the [DATA] keys (+, -).

a: Setting range: 0% to 100%

0%: Normal operation

-100%: Servo operation becomes mild near the neutral position

+100%: Servo operation becomes quick near the neutral position

b: When the [DATA] keys (+, -) are pressed simultaneously, the rate becomes 0%.

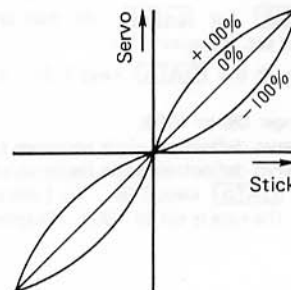
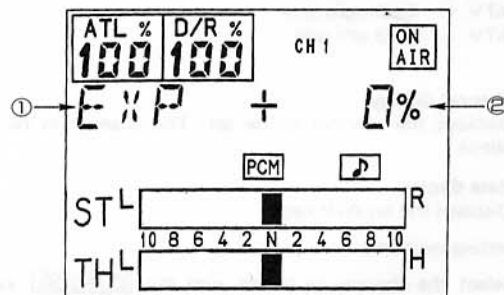

MODE To D/R

● FUNCTIONS AND DATA SETTING METHOD

Returning to initial display
Press the [MODE] keys and (▲) and (▼) keys simultaneously.

D/R D/R (Dual Rate)

<Function>

Adjusts the steering servo steering angle at the same rate at the left and right.

<Objective CH>

CH1

<Description of display>

① Function name (abbreviation)

② Rate display

Displays the set rate.

<Setting method>

Method 1: Fine adjust the rate with the one-touch buttons ([ST.D/R]) ⊕ and ⊖ at the right side of the transmitter.

Method 2: Set the rate with the [DATA] keys (⊕, ⊖).

a: Setting range: 0% to 100%

0%: Servo deflection angle becomes zero

100%: Zero deflection angle becomes maximum

b: When the [DATA] keys (⊕, ⊖) are pressed simultaneously, the rate is set to 100%.

When the one-touch buttons ([ST.D/R]) ⊕ and ⊖ are pressed simultaneously, the rate is set to 100%.

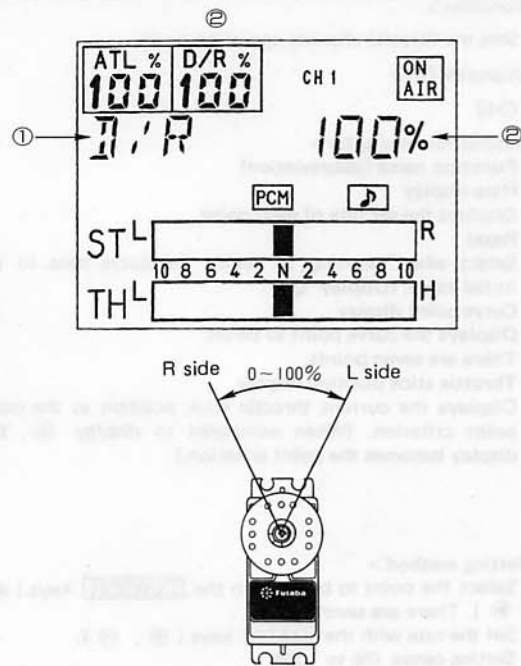

MODE To ATL

ATL Adjustable Throttle Limiter.

<Function>

Adjusts the throttle LOW side steering angle only.

<Objective CH>

CH2

<Description of display>

① Function name (abbreviation)

② Rate display

Displays the set ATL rate.

<Setting method>

Method 1: Fine adjust the rate with the one-touch buttons ([TH.ATL]) ⊕ and ⊖ at the left side of the transmitter.

Method 2: Set the rate with the [DATA] keys (⊕, ⊖).

a: Setting range: 0% to 100%

0%: Servo deflection angle becomes zero

100%: Servo deflection angle becomes maximum

b: When the [DATA] keys (⊕, ⊖) are pressed simultaneously, the rate is set to 100%.

When the one-touch buttons ([TH.ATL]) ⊕ and ⊖ are pressed simultaneously, the rate is set to 100%.

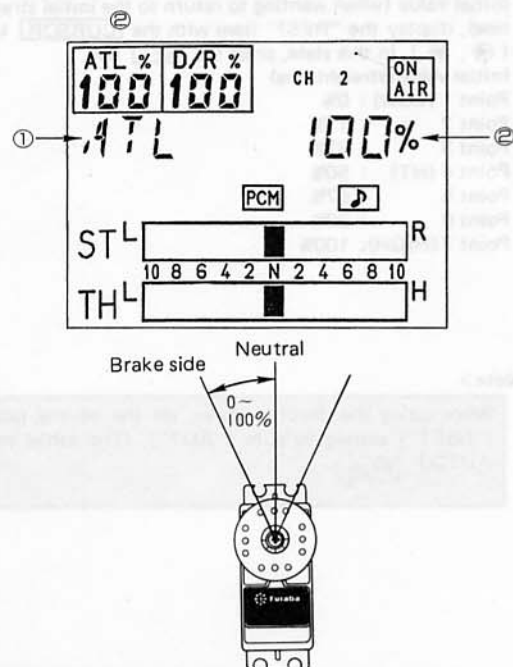

MODE To CURV

FUNCTIONS AND DATA SETTING METHOD

Returning to initial display
 Press the **MODE** keys and (▲) and (▼) keys simultaneously.

CURV

Throttle curve

Direct call

<Function>

Sets the throttle channel operation curve.

<Objective CH>

CH2

<Description of display>

- ① Function name (abbreviation)
- ② Rate display
Displays the set rate of each point.
- ③ Reset
Select when wanting to return the curve data to the initial value. (Display ③)
- ④ Curve point display
Displays the curve point to be set. There are seven points.
- ⑤ Throttle stick position display
Displays the current throttle stick position as the curve point criterion. (When compared to display ④, this display becomes the point criterion.)

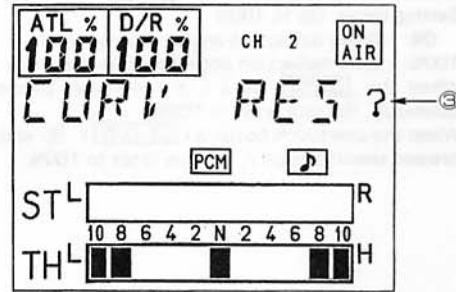
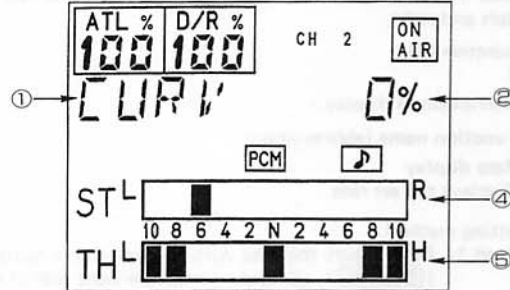

<Setting method>

- ① Select the point to be set with the **CURSOR** keys (◀, ▶). There are seven points.
- ② Set the rate with the **DATA** keys (+, -).
Setting range: 0% to 100%
0%: LOW side maximum
50%: Neutral
100%: HIGH side maximum
When the **DATA** keys (+, -) are pressed simultaneously, the point currently set is reset.
- ③ When wanting to return the rate of all the points to the initial value (when wanting to return to the initial straight line), display the "RES?" item with the **CURSOR** keys (◀, ▶). In this state, press the **SET** key.
Initial value (straight line)
Point 1 (LOW) : 0%
Point 2 : 17%
Point 3 : 33%
Point 4 (NT) : 50%
Point 5 : 67%
Point 6 : 83%
Point 7 (HIGH) : 100%

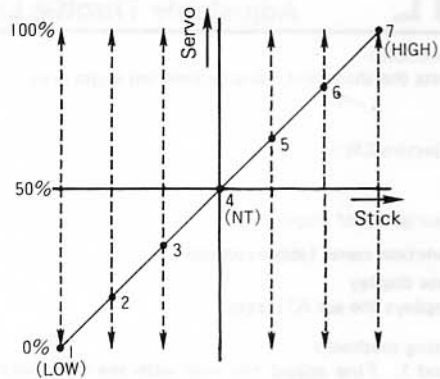

<Note>

When using the throttle curve, set the neutral position ("NSET") setting to auto ("AUT"). (The initial state is AUTO.) 

FUNCTIONS AND DATA SETTING METHOD

Returning to initial display
 Press the [MODE] keys and (▲) and (▼) keys simultaneously.

REV Reverse

<Function>

Reverses the servo operating direction centered about the neutral position.

<Objective CH>

CH1, CH2, CH3

<Description of display>

- ① Function name (abbreviation)
- ② Channel display
Displays the channel to be set.
- ③ Setting status display
Displays the setting status of each channel.

<Setting method>

- ① Select the channel to be set with the [CURSOR] keys (◀), (▶). (Display ②)
- ② Set the operating direction with the [DATA] keys (+, -). (Display ③)

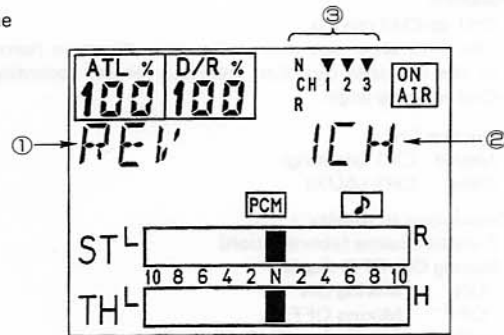

MODE To TWIN

TWIN Twin servo mixing.

<Function>

CH1 to CH3 mixing.
 Allows identical operation of the CH1 and CH3 with the CH1 stick.
 When the steering servo is made a twin servo by using independent left and right servos, toe-in and toe-out can be adjusted.

<Objective CH>

Master: CH1 (steering)
 Slave : CH3 (AUX)

<Description of display>

- ① Function name (abbreviation)
- ② Mixing ON/OFF display
"ON" : Mixing ON
"OFF" : Mixing OFF
- ③ Shows that mixing from CH1 to CH3 is on.
- ④ Rate display
Displays the mixing rate of each direction for CH1 to CH3.
"LEFT" : Steering left side rate
"RIGHT" : Steering right side rate

<Setting method>

- ① Select the item to be set with the [CURSOR] keys (◀, ▶).
- ② Set the rate with the [DATA] keys (+, -). (Displays ③, ④)
 Rate setting range: 0% to 110%
 0%: Same state as (OFF)
 +□□□%: CH1 and CH3 operate in the same direction
 -□□□%: CH1 and CH3 operate in opposite directions
 When the [DATA] keys (+, -) are pressed simultaneously, the rate is set to 100% for the symbol at that time.

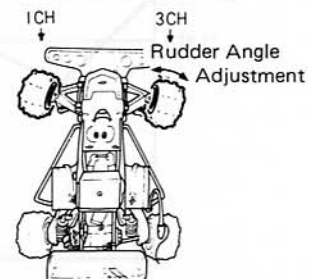
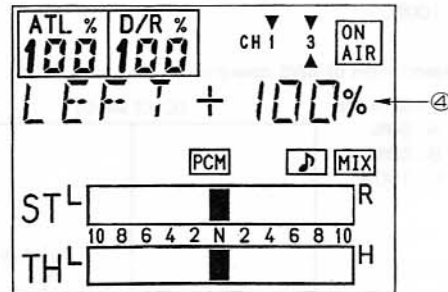
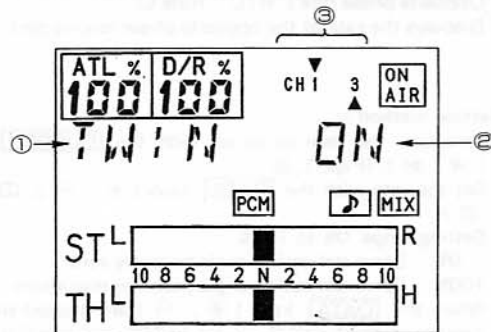

MODE To 4WS

FUNCTIONS AND DATA SETTING METHOD

Returning to initial display
 Press the [MODE] keys and (▲) and (▼) keys simultaneously.

4WS 4WS mixing.

<Function>

CH1 to CH3 mixing.
 The CH3 servo operates in the same direction (same phase) or the opposite direction (opposite phase) according to the CH1 steering angle.

<Objective CH>

Master: CH1 (steering)
 Slave : CH3 (AUX)

<Description of display>

- ① Function name (abbreviation)
- ② Mixing ON/OFF display
 "ON" : Mixing ON
 "OFF" : Mixing OFF
- ③ Indicates that CH1 to CH3 mixing is on.
- ④ Same phase to opposite phase switching point ("PTA": Point A)
 Displays the point at which operation switches from same phase to opposite phase by rate.
 0%: Neutral
 100%: Left and right maximum point
 Same phase rate ("RTB": Rate B)
 Displays the rate of the same phase mixing part.
 Opposite phase rate ("RTC": Rate C)
 Displays the rate of the opposite phase mixing part.

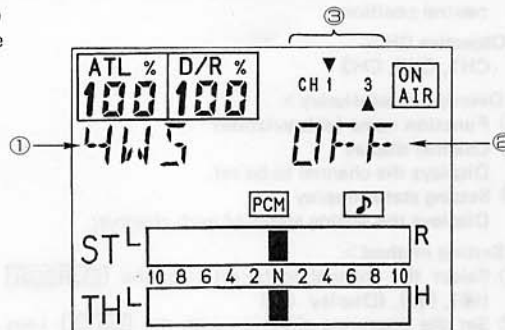

(Fig. 1)

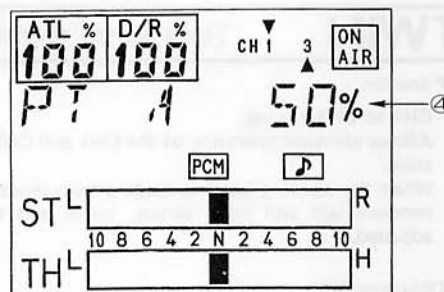

(Fig. 2)

<Setting method>

- ① Selection the item to be set with the [CURSOR] keys (◀, ▶). (Figs. 1, 2)
- ② Set the rate with the [DATA] keys (⊕, ⊖). (Display ②)
 Setting range: 0% to 100%
 0%: Servo deflection angle becomes zero
 100%: Servo deflection angle becomes maximum
 When the [DATA] keys (⊕, ⊖) are pressed simultaneously, rates A and B are set to 50% and rate C is set to 100%.

<Description of 4WS operation>

Initial state (CH3 servo)
 A: 50%
 B: 50%
 C: 100%

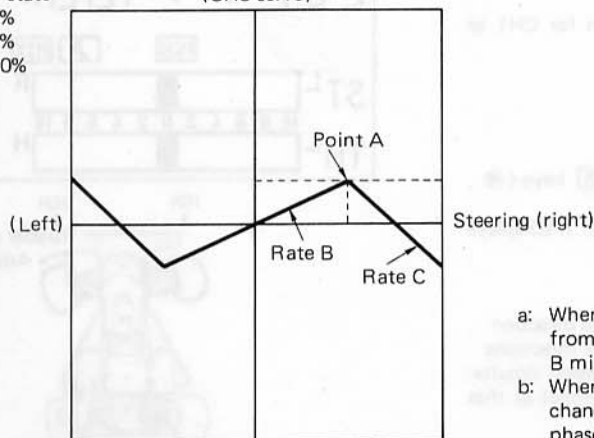

- (1) When steering operating angle at minimum



- (2) When steering operating angle at medium

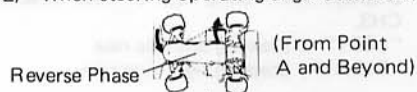

- (3) When steering operating angle at maximum

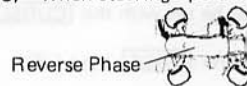

- a: When the steering stick is moved slowly to the right from the NT position, the CH3 servo changes by the B mixing rate in the same phase relative to CH1.
- b: When steering reaches point A, the CH3 servo changes by the C mixing amount in the opposite phase.



FUNCTIONS AND DATA SETTING METHOD

Returning to initial display
 Press the **MODE** keys and (▲) and (▼) keys simultaneously.

TILT Tilt mixing.

<Function>

Bi-Directional mixing from CH1 to CH3 and from CH3 to CH1.

This function is mainly used for boat outboard engine steering strut.

The rudder is moved to the left and right by CH1 operation and is moved up and down by CH3 operation.

<Objective CH>

Master: CH1, CH3

Slave : CH3, CH1

<Description of display>

- ① Function name (abbreviation)
- ② Mixing ON/OFF display
 "ON" : Mixing ON
 "OFF" : Mixing OFF
- ③ Indicates that mixing from CH1 to CH3 or from CH3 to CH1 is on.
- ④ 1-3 rate
 Displays the CH1 to CH3 rate.
 3-1 rate
 Displays the CH3 to CH1 rate.

<Setting method>

- ① Select the item to be set with the **CURSOR** keys (◀, ▶). (Figs. 1, 2)
- ② Set the rate with the **DATA** keys (+, -). (Displays ④, ④)
 a: Setting range: 0% to 100%
 0%: Same state as (OFF)
 100%: Servo deflection angle becomes maximum
 b: When the **DATA** keys (+, -) are pressed simultaneously, the rate is set to 100% for the sign at that time.

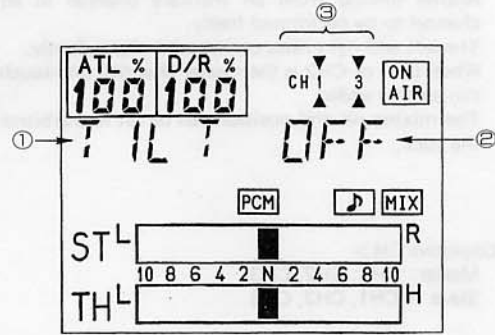

(Fig. 1)

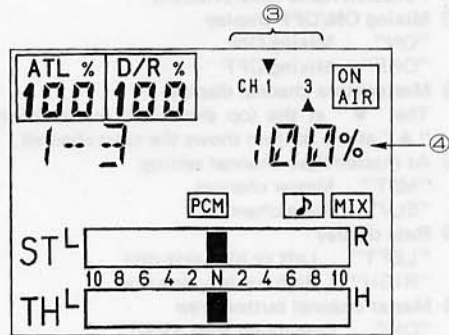

(Fig. 2)

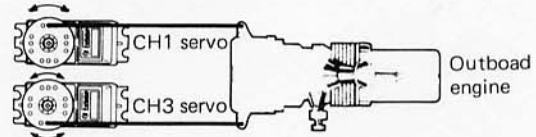

MODE To PMX1

● FUNCTIONS AND DATA SETTING METHOD

Returning to initial display
 Press the [MODE] keys and (▲) and (▼) keys simultaneously.

PMX1 Programmable mixing 1.

<Function>

Allows mixing from an arbitrary channel to an arbitrary channel to be performed freely.
 The left and right rates can be set independently.
 When CH1 or CH2 is the master channel, one-touch trim data can also be added.
 The mixing neutral position can be set to an arbitrary point of the stick.

<Objective CH>

Master: CH1, CH2, CH3
 Slave : CH1, CH2, CH3

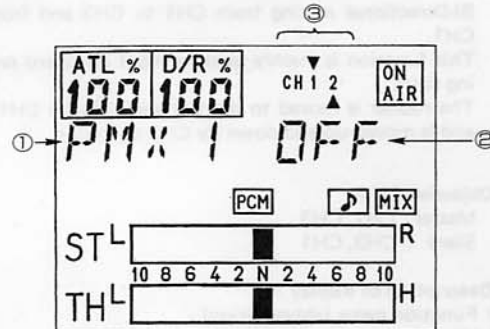

(Fig. 1)

<Description of display>

- ① Function name (abbreviation)
- ② Mixing ON/OFF display
 "ON" : Mixing ON
 "OFF" : Mixing OFF
- ③ Master/slave channel display
 The "▼" at the top shows the master channel and the "▲" at the bottom shows the slave channel.
- ④ At master/slave channel setting:
 "MST" : Master channel
 "SLV" : Slave channel
- ⑤ Rate display
 "LEFT" : Left or high side rate
 "RIGH" : Right or low side rate
- ⑥ Master channel button trim
 "ON" : One-touch trim added
 "OFF" : One-touch trim not added
- ⑦ Mixing center point display
 0%: Right or low side maximum
 50%: Neutral
 100%: Left or high side maximum

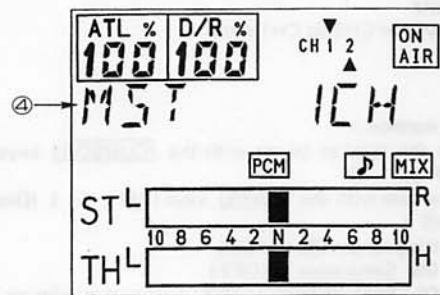

(Fig. 2)

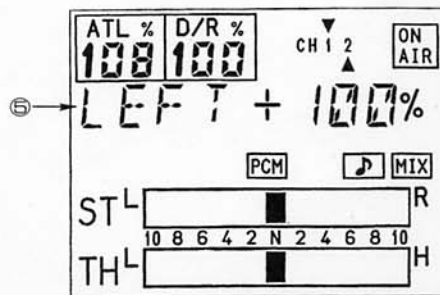

(Fig. 3)

Continued on next page.

● FUNCTIONS AND DATA SETTING METHOD

Returning to initial display
 Press the [MODE] keys and (▲) and (▼) keys simultaneously.

Continued from preceding page.

<Setting method>

- ① Select the item to be set with the [CURSOR] keys (◀, ▶). (Figs. 1-5)
- ② Set the rate with the [DATA] keys (+, -).
 - a: Master/slave channel (display ④).
 - b: Rate setting (display ⑤) 0% to ±100%
 - 0%: Same state as (OFF).
 - ±100%: Servo deflection angle becomes maximum
 When the [DATA] keys (+, -) are pressed simultaneously, the rate is set to 100% for that sign.
 - c: Trim ON/OFF
 - ⊖ key: OFF
 - ⊕ key: ON
- ③ Mixing neutral point setting
 Move the master channel stick to the point to be set and press the [SET] key. (Display ⑦)

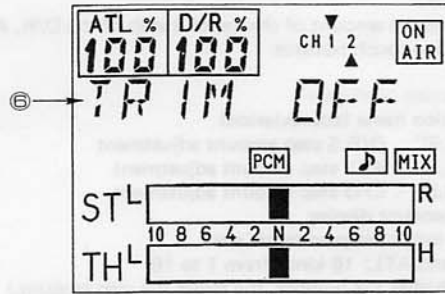

(Fig. 4)

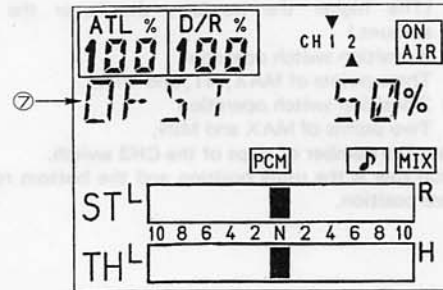

(Fig. 5)

MODE To PMX2

PMX2 Programmable mixing 2.

<Function>

Same as programmable mixing 1.

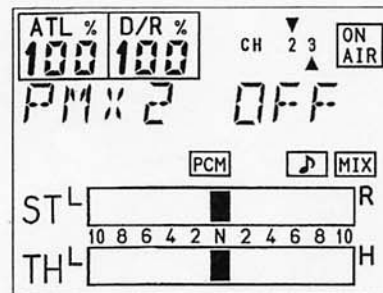

MODE To D/R.S

● FUNCTION AND DATA SETTING

Returning to initial display
 Press the **MODE** keys and (▲) and (▼) keys simultaneously.

D/R.S D/R, ATL, and CH3 ones-touch button stop amount adjustment.

<Function>

Adjusts the amount of change of 1 step of the D/R, ATL, and CH3 one-touch buttons.

<Description of display>

① Function name (abbreviation)

"D/R.S" : D/R.S step amount adjustment
 "ATL.S" : ATL step amount adjustment
 "3CH.S" : CH3 step amount adjustment

② Step amount display

The kinds of step amounts are:

D/R and ATL: 16 kinds from 1 to 16

(The higher the number, the larger the step amount.)

CH3: The following 16 kinds:

5, 10, 15, 20, 25, 30, 35, 40, 50, 60, 70, 80, 90, 100, 3PS, 2PS

(The higher the number, the larger the step amount.)

3PS : 3-position switch operation

Three points of MAX, NT, and MIN.

2PS : 2-position switch operation

Two points of MAX and MIN.

③ Displays the number of steps of the CH3 switch.

The top row is the units position and the bottom row is the tens position.

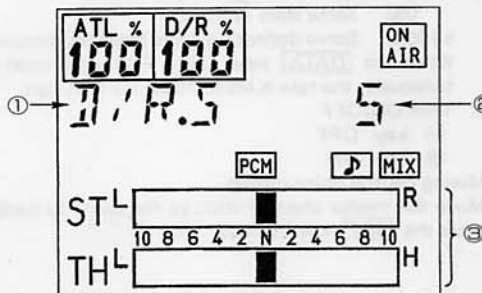

<Setting method>

① Select the D/R, ATL, or CH3 switch setting with the **CURSOR** keys (◀, ▶).

② Set the step amount with the **DATA** keys (⊕, ⊖).

⊕ key: Step amount increases

⊖ key: Step amount decreases

When the **DATA** keys (⊕, ⊖) are pressed simultaneously, the D/R, ATL, and 3CH switch step amounts are set to 5, 5, and 25, respectively.

● FUNCTIONS AND DATA SETTING METHOD

Returning to initial display
 Press the **MODE** keys and (▲) and (▼) keys simultaneously.

Trm.s. One-touch trim amount adjustment.

<Function>

Adjusts the amount of change of 1 step of CH1 and CH2 one-touch trim.
 CH2 one-touch trim does not change at the high and low sides.

<Objective CH>

CH1, CH2

<Description of display>

- ① Function name (abbreviation)
- ② Channel display
Shows the channel to be set.
The channel to be set blinks.
- ③ Step amount display
There are 10 step amounts from 1 to 10.
- ④ Displays the number of one-touch trim steps.
The top row shows the number of steps of CH1 (steering) one-touch trim and the bottom row shows the number of steps of CH2 (throttle) one-touch trim.

<Setting method>

- ① Select the channel to be set with the **CURSOR** keys (◀, ▶). (Display ②)
- ② Set the step amount with the **DATA** (⊕, ⊖) keys. (Display ③)
Setting range: 1 to 10
1 : Maximum steps becomes small (Approximately 0.1°)
10 : Maximum step becomes large (Approximately 1.2°)
When the **DATA** keys (⊕, ⊖) are pressed simultaneously, the step amount is set to 4. (Initial state)

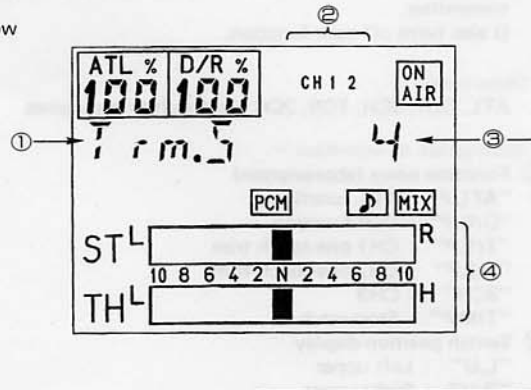

<Step Increments>

- 1 (Minimum) : Approx. 0.1 degrees
- 4 (Standard) : Approx. 0.5 degrees
- 10 (Maximum) : Approx. 1.2 degrees

MODE To ALT.P

● FUNCTIONS AND DATA SETTING METHOD

Returning to initial display
 Press the **[MODE]** keys and **(▲)** and **(▼)** keys simultaneously.

ATLP One-touch button position setting.

<Function>

Arbitrarily sets the position of the switches on the top of the transmitter.
 It also turns off each function.

<Objectives>

ATL, D/R, 3CH, 1CH, 2CH one-touch trim switches

<Description of operation>

① Function name (abbreviation)

"ATL.P" : ATL function
 "D/R.P" : D/R function
 "Tr1.P" : CH1 one-touch trim
 "Tr2.P" : CH2 one-touch trim
 "3CH" : CH3
 "TIM.P" : Stopwatch

② Switch position display

"L.U" : Left upper
 "R.U" : Right upper
 "L.S" : Left side
 "R.S" : Right side
 "FRO" : Front
 "OFF" : Switch function is turned off.

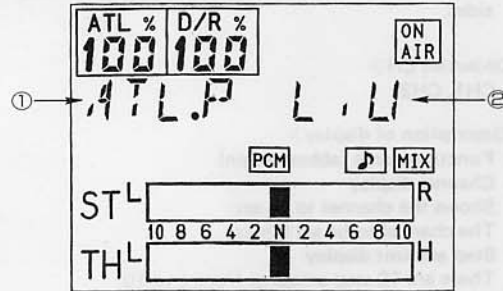

<Setting method>

- ① Select the switch function to be set with the **[CURSOR]** keys (◀, ▶). (Display ①)
- ② Select the switch position to be set with the **[DATA]** keys (⊕, ⊖). (Display ②)

*However, "TIM.P" (Stopwatch) button position is "FRO" or "OFF".



● FUNCTIONS AND DATA SETTING METHOD

Returning to initial display
 Press the **MODE** keys and (▲) and (▼) keys simultaneously.

NSET Throttle neutral position setting.

<Function>

Two neutral positions are selected by 2CH switch neutral adjuster.

The CH2 servo neutral position can be set to the 1:1 or 2:1 state whether the adjuster is in the 1:1 or 2:1 state.

<Objective CH>

CH2

<Description of display>

① Function name (abbreviation)

② Neutral position display

“AUT” : Servo high side and low side ratio is switched automatically to 1:1 or 2:1 according to the state of the neutral adjuster.
 (Display ②)

“1:1” : Servo high side and low side ratio is set to 1:1 regardless of the state of the adjuster.

“2:1” : Servo high side and low side ratio is set to 2:1 regardless of the state of the adjuster.

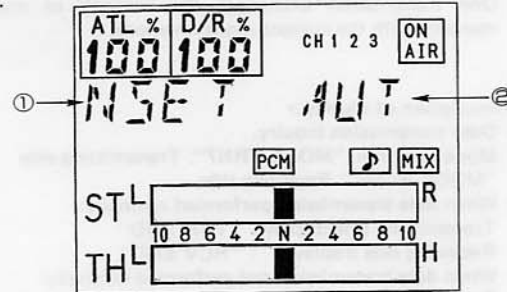

<Setting method>

Select the neutral position to be set with the **DATA** keys (⊕, ⊖).

<Note>

When using the throttle curve, set the neutral position to “AUT” (auto).



 To DATA

FUNCTIONS AND DATA SETTING METHOD

Returning to initial display
 Press the [MODE] keys and (▲) and (▼) keys simultaneously.

DATA Data transmission function.

<Function>

The contents of the model memory can be sent to another transmitter (FP-T3UCP) by using the special cable. One transmission exchanges the contents of one model memory with the current model memory.

<Description of display>

- ① Data transmission inquiry.
- ② Mode selection. "MODE TRN?": Transmitting side
 "MODE RCU?": Receiving side
- ③ When data transmission performed normally:
 Transmitting side display: "TRN END"
 Receiving side display: "RCV END"
 When data transmission not performed normally:
 Transmitting side display: "TRN ERR"
 Receiving side display: "RCV ERR"

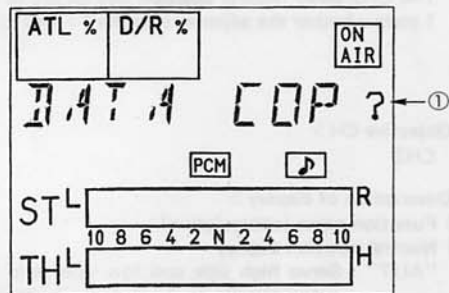

<Operation>

- ① Connect the two transmitters with the special cable.
- ② When "DATA COP" is displayed, press the [SET] key one time. The display switches to the "MODE" display.
- ③ Select "TRN" or "RCV" with the [DATA] keys (⊕, ⊖).
- ④ At the end of transmit or receive selection at both transmitters, press the [SET] key of each transmitter.
- ⑤ When "END" is displayed at both transmitters, transmission is complete. When "ERR" is displayed, the receiving side data returns to its state before transmission was performed.

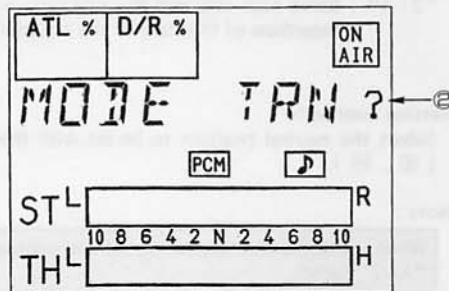

Transmitter connection

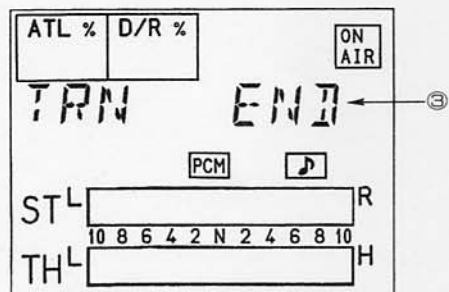
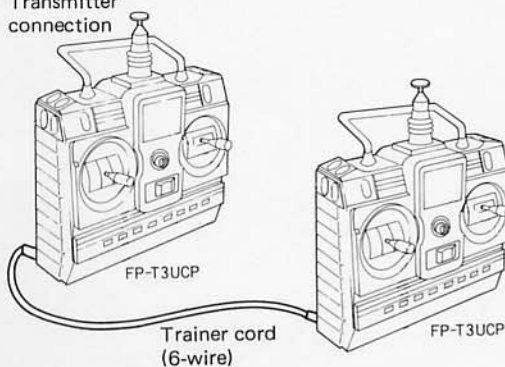

<Notes>

- ① Transmission to the receiver is interrupted during data transmission.
- ② The one-touch buttons are inoperative at this function screen.



● FUNCTIONS AND DATA SETTING METHOD

Returning to initial display
 Press the [MODE] keys and (▲) and (▼) keys simultaneously.

F/S Fail safe function (F/S) (PCM mode only)

<Function>

Sets the fail safe function for each channel.
 When the fail safe function is OFF, the preceding state is held until the interference disappears.
 When the fail safe function is ON, the servo moves to the preset position. However, the set immediately returns to normal when the interference disappears. When the throttle channel (CH2) fail safe position is set to the stop position, when interference occurs, the vehicle stops.

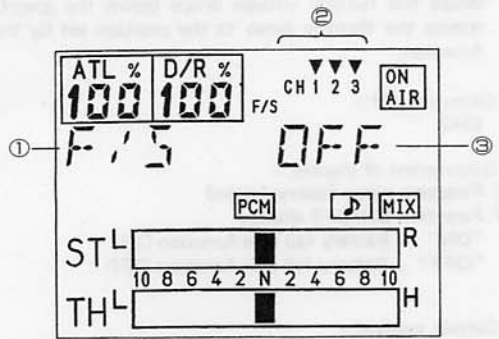

<Objective CH>

CH1, CH2, CH3

<Description of display>

- ① Function name (abbreviation)
 - ② CH NO. display
 - ③ Servo position display
- "OFF" : Fail safe function OFF
 (****) : Fail safe function ON
 0% : Left/low side
 50% : Neutral
 100% : Right/high side

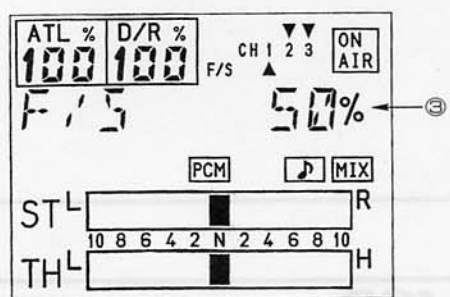

<Setting method>

- ① Select the channel to be set with the [CURSOR] keys (◀, ▶). (Display ②)
- ② Select function ON/OFF with the [DATA] keys (+, -). (Display ③)
- ③ When fail safe function ON was selected, operate the stick, etc. and set the servo to the position to be set. When the [SET] key is pressed, the position of the servo at that time is memorized as the fail safe point. (Display ③)



● FUNCTIONS AND DATA SETTING METHOD

Returning to initial display
 Press the [MODE] keys and (▲) and (▼) keys simultaneously.

B/F.S Battery fail safe function (B/F.S) (PCM mode only)

<Function>

When the battery voltage drops below the specified value, moves the throttle servo to the position set by the fail safe function.

<Objective CH>
 CH2

<Description of display>

- ① Function name (abbreviation)
 - ② Function ON/OFF display
- "ON" : Battery fail safe function ON
 "OFF" : Battery fail safe function OFF

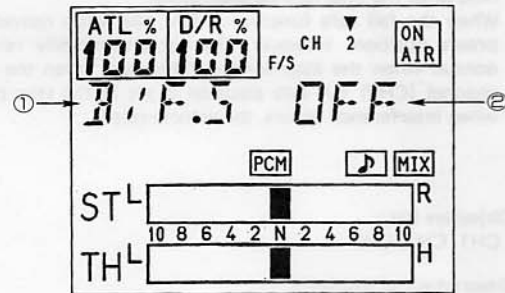

<Setting method>

- ① Select function ON/OFF with the [DATA] keys (⊕, ⊖).

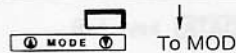

MOD Modulation (PCM/PPM)

<Function>

Switches the modulation mode between PCM and PPM.

<Description of display>

- ① Function name (abbreviation)
 - ② Setting display
 - ③ Operation mode display
- "PCM" : Selected when set to PCM mode.
 "PPM" : Selected when set to PPM mode.

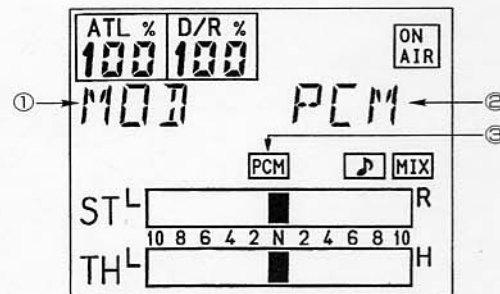

<Setting method>

- ① Select the mode to be set with the [DATA] keys (⊕, ⊖).
- ② Turn the power off and on.

<Note>

The mode does not change until the power is turned off.
 Display ③ "PCM" or "PPM" shows the actual mode.



FUNCTIONS AND DATA SETTING METHOD

Returning to initial display
 Press the **MODE** keys and (▲) and (▼) keys simultaneously.

BUZZ

Buzzer function volume switching

<Function>

Switches the volume of the buzzer that sounds when a switch is operated or the battery voltage is low. It also turns off the buzzer.

<Description of display>

- ① Function name (abbreviation)
- ② Volume display
 "OFF" : Buzzer off
 "HI" : Buzzer maximum
 "LO" : Buzzer minimum

<Setting method>

- ① Select ON/OFF with the **DAT** keys (+ , -)

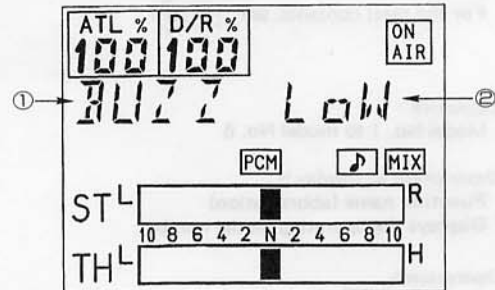

MODE To SRVO

SRVO

Servo operation display.

<Function>

Displays the operation status of each servo.

<Description of display>

- ① Function name (abbreviation)
- ② Channel display
- ③ Stick operation amount
 Displays the amount and direction of operation of the stick without steering adjustment and reverse.
- ④ Servo operation amount
 Displays the amount and direction of operation of the servo with steering adjustment and reverse, mixing amount, etc. added.

<Operation>

- ① Select the channel with the **CURSOR** keys (◀ , ▶).
 (Display ②)

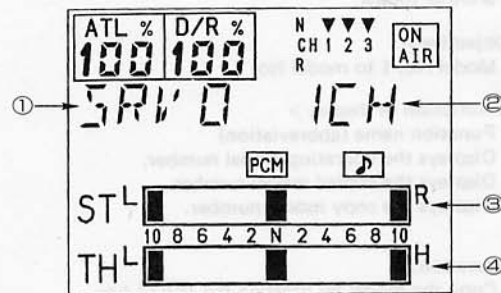

MODE To ALL CLR

● FUNCTIONS AND DATA SETTING METHOD

Returning to initial display
 Press the **MODE** keys and (▲) and (▼) keys simultaneously.

ALL CLR All clear function.

<Function>

Resets (initializes) the contents of the currently operating model.

For the reset contents, see [P.38](#)

<Objective>

Model No. 1 to model No. 6

<Description of display>

- ① Function name (abbreviation)
- ② Displays the operating model number.

<Operation>

Press the **SET** key.

<Note>

The one-touch buttons are inoperative when this function screen is displayed.

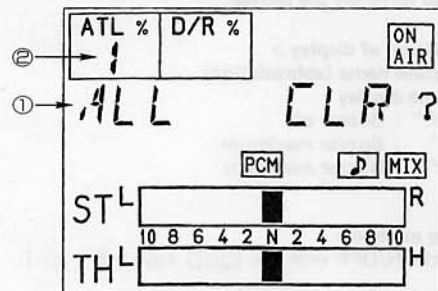

COP Model copy function.

<Function>

Copies the contents of the currently operating model to another model.

<Objective>

Model No. 1 to model No. 7

<Description of display>

- ① Function name (abbreviation)
- ② Displays the operating model number.
- ③ Displays the copied model number.
- ④ Displays the copy model number.

<Operation>

Copy the model by pressing the **SET** key.

<Note>

The one-touch buttons are inoperative when this function screen is displayed.

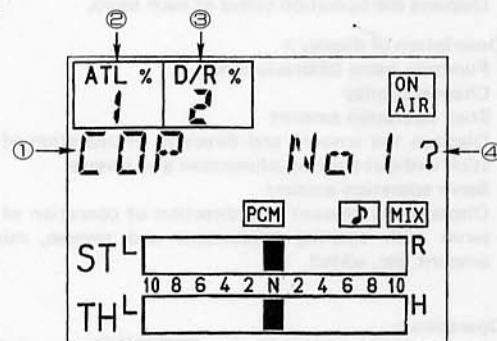

● FUNCTIONS AND DATA SETTING METHOD

Returning to initial display
 Press the [MODE] keys and (▲) and (▼) keys simultaneously.

SEL Model select function

Direct call

<Function>
 Selects the model.

<Objective>
 Model No. 1 to model No. 6

<Description of display>

- ① Function name (abbreviation)
- ② Displays the operating model number.
- ③ Displays the model number to be selected.

<Operation>

- ① Select the model with the [CURSOR] keys (◀, ▶).
- ② Set the selected model with the [SET] key.

<Note>

The one-touch buttons are inoperative when this function screen is displayed.

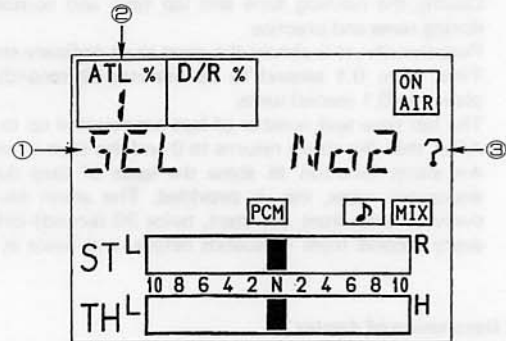

RCL Model recovery function

<Function>
 Automatically writes the initial data to model No. 7 when the power is turned on and when the model select function was executed.
 Rewriting is possible when wanting to reset the data from the beginning due to a setting error, etc.

<Objective>
 Model No. 7

<Description of display>

- ① Function name (abbreviation)
- ② Displays the operating model number.

<Operation>

- ① Copy model No. 7 to the currently operating model with the [SET] key.

<Note>

The one-touch buttons are inoperative when this function screen is displayed.

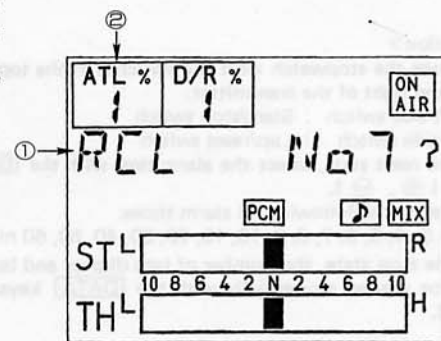

FUNCTIONS AND DATA SETTING METHOD

Returning to initial display
 Press the **MODE** keys and (▲) and (▼) keys simultaneously.

AL stopwatch function.

<Function>

Counts the running time and lap time and number of laps during races and practice. Functionally, it is almost the same as an ordinary stopwatch. Time from 0.1 second to 59 minutes 59 seconds 9 is displayed in 0.1 second units. The lap time and number of laps are counted up to 25 times. After that the count returns to 0 and the time is overwritten. An alarm function to show the lapse of time during time endurance races, etc. is provided. The alarm sounds once every minute from the start, twice 30 seconds before, once every second from 4 seconds before, and twice at the time.

<Description of display>

- ① Alarm time setting display
 Displayed when the stopwatch is set.
 Displays the time the alarm sounds from starting.
- ② Total time display
 Displayed while the stopwatch is running or in the stopped state.
 Displays the total time from starting.
- ③ Lap time display
 Displayed while the stopwatch is running and in the stopped state.
 While the stopwatch is running, the lap time is displayed for approximately five seconds after the lap switch is pressed.
- ④ Number of laps display
 Displays the total number of laps while the stopwatch is running.
 When the stopwatch is not running, displays the number of laps and the lap time at that time.

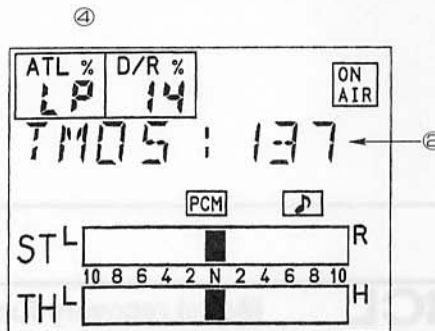
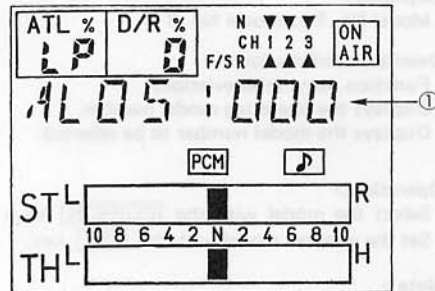

<Operation>

- ① Operate the stopwatch with the switches at the top front left and right of the transmitter.
 Right side switch : Start/stop switch
 Left side switch : Lap/reset switch
- ② In the reset state, select the alarm time with the **DATA** keys (⊕, ⊖).
 There are the following 16 alarm times:
 1, 2, 3, 4, 5, 6, 7, 8, 9, 10, 15, 20, 30, 40, 50, 60 minutes
- ③ In the stop state, the number of laps display and lap time can be viewed sequentially with the **DATA** keys (⊕, ⊖).

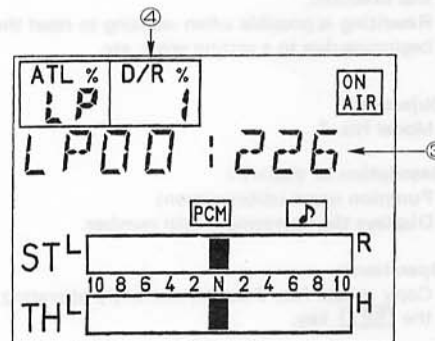

<Note>

For stopwatch, the one-touch buttons can be used when an effective function screen is displayed.

④ MODE ① To (Initial display)

■ DSC (Direct Servo Control) function

Use this function when wanting to adjust your own vehicle without radiating radiowaves during meets and races and when the same band is used. (The DSC cord is sold separately.)

CAUTION
 ● Always turn off the transmitter power switch.

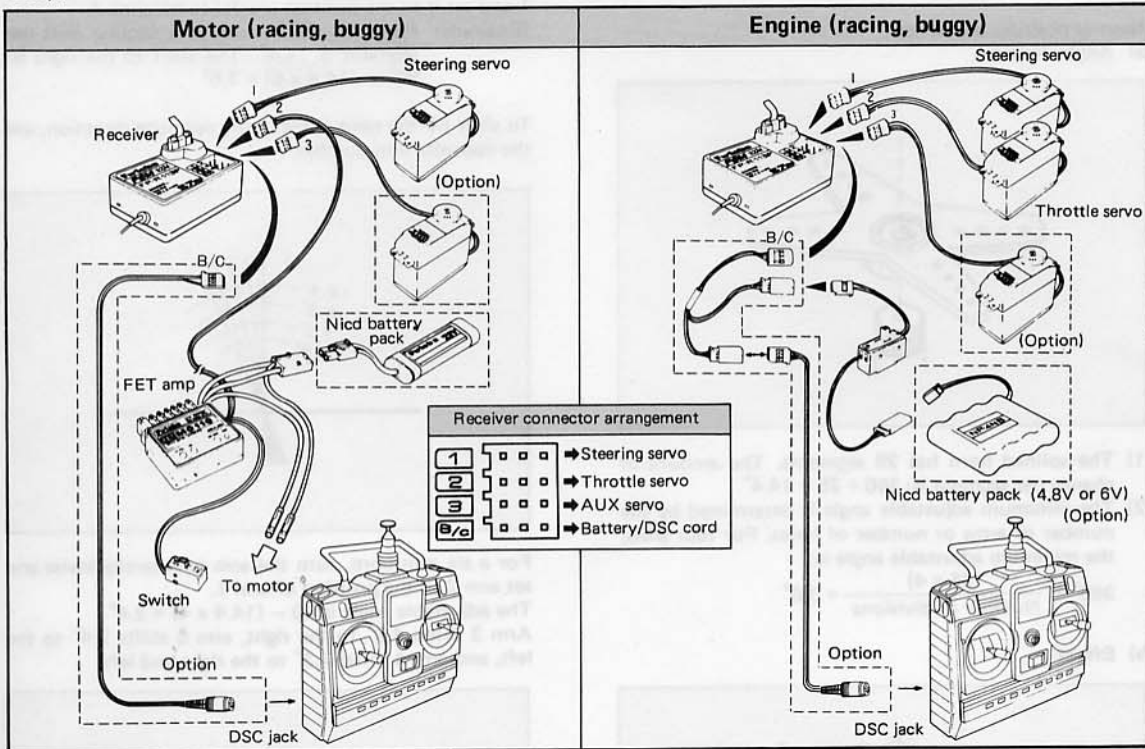

■ Stick lever tension adjustment

1 Remove the transmitter back cover.

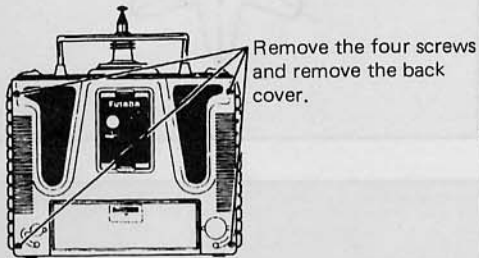

2 Adjust the spring strength.

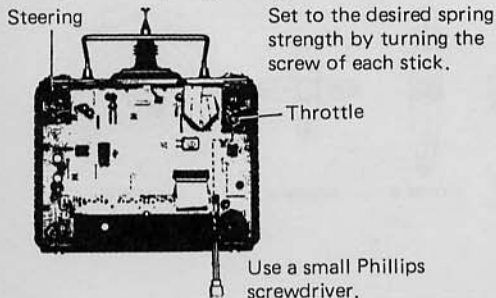

■ Non-slip adjustable lever head adjustment

The length of the lever head can be adjusted.

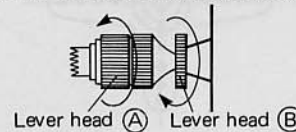

Unlock lever heads (A) and (B) by turning them in the arrow directions and adjust the stick to the most comfortable length.

Using the stick adapter

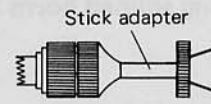

Use the desired stick adapter.

■ Mechanical ATL function adjustment

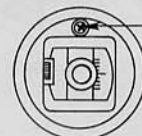

(Throttle stick)

When turned counterclockwise, the limiter is applied.

Note: To prevent the internal stopper from falling out, do not turn counterclockwise more than necessary.

● USING THE ACCESSORIES

■ SPLINED HORNS

The splined horns allow adjustment of the servo neutral position at the servo horn.

Neutral position adjustment

a) Angle divisions

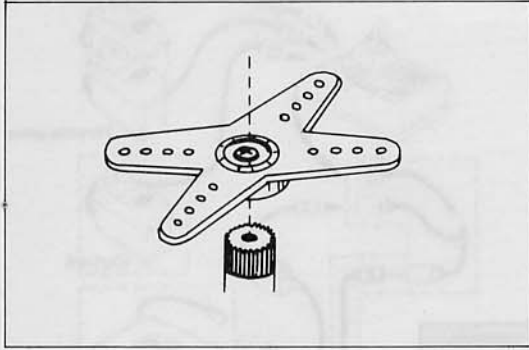

- 1) The splined horn has 25 segments. The amount of change per segment is; $360 \div 25 = 14.4^\circ$.
- 2) The minimum adjustable angle is determined by the number of arms or number of holes. For four arms, the minimum adjustable angle is:

$$360^\circ \div \frac{(25 \times 4)}{\text{Number of divisions}} = 3.6^\circ$$

b) Effect

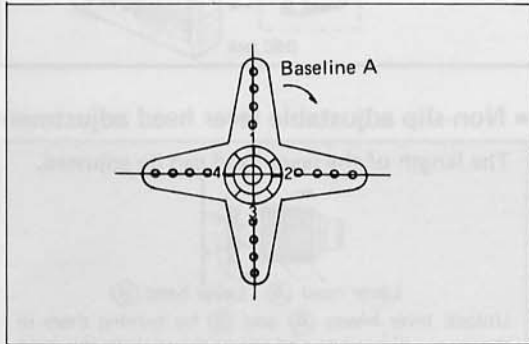

To shift the holes center line to the right (clockwise) relative to baseline A, shift arm 2 to the position of arm 1 and set it to the position closest to baseline A.

(Example) For a four arm horn, the angular shift per segment is 14.4° . The shift to the right is: $90^\circ - (14.4 \times 6) = 3.6^\circ$

To shift by the same angle in the opposite direction, use the opposite arm number.

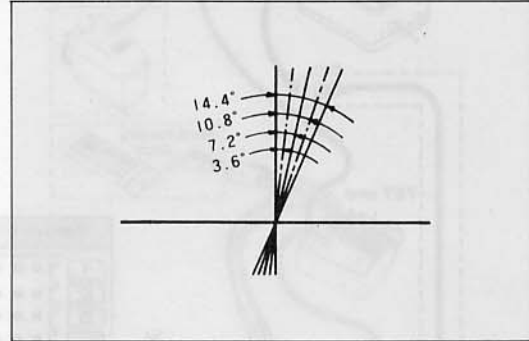

For a six arm horn, turn the arm counterclockwise and set arm 2 to the position of arm 1.

The adjustable angle is $60 - (14.4 \times 4) = 2.4^\circ$. Arm 3 shifts 4.8° to the right, arm 6 shifts 2.4° to the left, and arm 4 shifts 7.2° to the right and left.

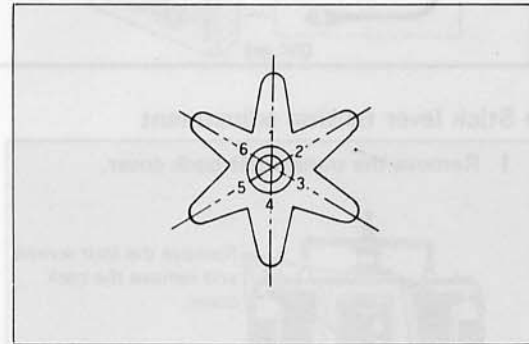

The following splined horns are optional.

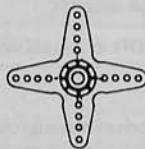

HORN A
(FSH-6X)



HORN B
(FSH-6S)



HORN C
(FSH-6R)



HORN D
(FSH-6W)



HORN E

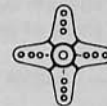

HORN F

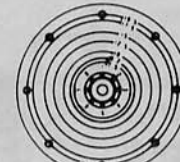

HORN G

■ Digital Proportional Frequencies (FOR U.S.A.)

- The frequency of Futaba digital proportional sets can be changed within their own band. There are 2 different bands for you to choose from (27 MHz and 75 MHz.) Please see chart listed below for specific frequency and its intended use. Please note there are specific frequencies allocated for aircraft only and surface only use.
- The frequency can be changed within the same BAND by using a precisely matched pair of Futaba crystals. However, Futaba recommends that you return your system to our factory service department for frequency changing, as tuning may be necessary for proper operation. Changing frequency from one band to another is NOT possible.
- Always change frequency flag when frequency is changed. The frequency flag is to be attached to the top of antenna and the channel designation to the base. (See Drawing)
- It is illegal to change crystals on 75 MHz bands in the U.S.A.

■ ANTENNA FREQUENCY FLAG

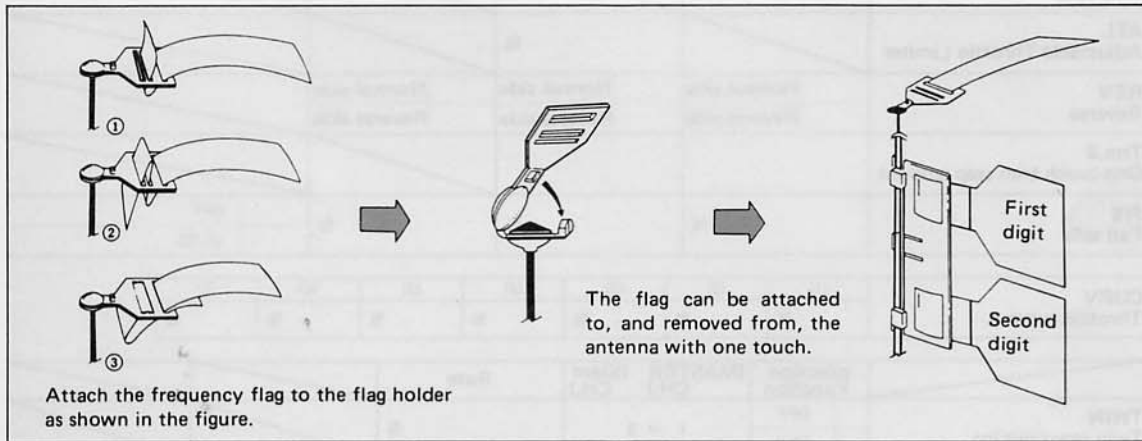

■ Frequency Channel No. Flag Color (FOR U.S.A.)

26-27 MHz – Aircraft/car/boat		72 MHz – Aircraft only			
	Color	72.030	12	*72.470	34
26.995	Brown	*72.070	14	72.550	38
27.045	Red	*72.110	16	72.590	40
27.095	Orange	*72.150	18	72.630	42
27.145	Yellow	*72.190	20	72.670	44
27.195	Green	*72.230	22	72.710	46
27.255	Blue	*72.270	24	72.750	48
		*72.310	26	72.790	50
50/53 MHz – Aircraft/car boat –		*72.350	28	72.830	52
Fcc Amature License required		*72.390	30	72.870	54
(2 and 3 channels not produced on		*72.430	32	72.910	56
these frequencies.)					
	Channel No.	75 MHz – Car/Boat only			
50.800	RC00	75.430	62	75.750	78
50.840	RC02	75.470	64	75.790	80
50.880	RC04	75.510	66	75.830	82
50.920	RC06	75.550	68	75.870	84
50.960	RC08	75.590	70	*75.910	86
	Color	*75.630	72	*75.950	88
53.100	Black-Brown	75.670	74	*75.990	90
53.200	Black-Red	75.710	76		
53.300	Black-Orange				
53.400	Black-Yellow				
53.500	Black-Green				
53.600	Black-Blue				
53.700	Black-Violet				
53.800	Black-Gray				

* Effective JAN 1, 1988

● FP-T3UCP DATA SHEET

● Copy and use

Model No.	N SET Throttle neutral position	AUT, 1:1, 2:1	B/F.S Battery fail safe		BUZZ Buzzer volume switching	Low, HI, OFF	AL Stopwatch (alarm)	Minutes
			OFF-ON	%				
			1 Steering	2 Throttle	3 A U X			
ATV Adjustable Travel Volume	R	%	L	%	-	%		
	L	%	H	%	+	%		
SUB.T Sub trim		%		%				
EXP Exponential		%						
D/R Dual rate		%						
ATL Adjustable Throttle Limiter				%				
REV Reverse		Normal side	Normal side	Normal side				
		Reverse side	Reverse side	Reverse side				
Trm.S One-touch trim step amount								
F/S Fail safe		%		%		%	OFF (F/S)	

CURV Throttle curve	(1)	(2)	(3)	(4)	(5)	(6)	(7)
	%	%	%	%	%	%	%

	selection Function	(MASTER CH.)	(Slave CH.)	Rate				
TWIN Twin servo mixing	OFF (ON)	1 → 3		%				
4WS 4WS mixing	OFF (ON)	1 → 3		(A) %	(B) %	(C) %		
TILT Tilt mixing	OFF (ON)	1 → 3		(1→3) %	(3→1) %			
PMX1 Programmable mixing 1	OFF (ON)	→		%			(Trim data) OFF-ON	(Neutral offset) %
PMX2 Programmable mixing 2	OFF (ON)	→		%			(Trim data) OFF-ON	(Neutral offset) %

D/R.S One-touch button step amount	D/R	ATL	3CH

ATL.P One-touch button position	ATL	D/R	Tr 1	Tr 2	3 CH	TIM

FUNCTIONS

Function name	Setting point	Initial value	Setting range	Remarks
(Initial display)	—	—	—	Various display P.12
MODL Model No. display	—	—	—	Fail safe position conforms to F/S function setting P.13
ATV Adjustable Travel Volume	All CH Rate of each direction	100%	0~100%	P.13
SUB.T Sub trim	Steering and throttle rate	0%	0~±100%	P.14
EXP Exponential	Steering rate	0%	0~±100%	P.14
D/R Dual rate	Steering rate	100%	0~100%	One-touch buttons and edit keys are settable P.15
ATL Adjustable Throttle Limiter	Throttle rate	100%	0~100%	One-touch buttons and edit keys are settable P.15
CURV Throttle curve	Throttle curve	(Point) (Rate) 0 17 33 50 67 83 100%	(1) (2) (3) (4) (5) (6) (7) 0~100%	P.16
REV Reverse	All CH	Normal side	Normal/reverse	P.17
TWIN Twin servo mixing	Steering left and right mixing rate	Function selection Rate OFF +100%	OFF/(ON) 0~±110%	1CH→3CH P.17
4WS 4WS mixing	Point A, rate B, rate C	Function selection Rate (A)50% (B)50% (C)100%	OFF/(ON) 0~100%	1CH→3CH P.18
TILT Tilt mixing	CH1→3, CH3→1 mixing rate	Function selection Rate (1→3)+100% (3→1)-100%	OFF/(ON) 0~±100%	1CH→3CH P.19
PMX1 Programmable mixing 1	Between arbitrary CHs Each direction mixing rate Addition of trim data Neutral offset	Function selection CH setting Rate Trim data Offset OFF (Master CH)CH1 (Slave CH)CH2 +100% OFF 50%	OFF/(ON) 1~3CH 0~±100% OFF/ON 0~100%	P.20
PMX2 Programmable mixing 2		(Same as above)		P.21
D/R.S One-touch trim step amount	D/R, ATL, CH3 one-touch button step amount	(D/R), (ATL), (3CH) 5 5 25	(D/R, ATL) (3CH) 1~16 5, 10, 15, 20, 25, 30, 35, 40 50, 60, 70, 80, 90, 100, 3PS, 2PS	P.22
Trm.S One-touch trim step amount	Steering, throttle one-touch trim step amount	4	1~10	P.23
ATL.P One-touch button position	Position of each one-touch button	(ATL)(D/R)(Tri)(Tr2)(3CH)(TIM) LU RU RS LS OFF FRO	L.U, R.U, R.S, L.S, FRO or OFF	P.24
NSET Throttle neutral position	Throttle neutral adjuster position	AUT	AUT, 1:1, 2:1	P.25
DATA Data transmission	—	—	—	Transmission of model data between transmitters P.26
F/S Fail safe	All CHs fail safe position	Function selection Position OFF 50%	OFF/(F/S) 0~100%	Position setting by stick P.27
B/F.S Battery fail safe	B/F.S function selection	OFF	OFF/ON	Model memory No. display F/S set CH display P.28
MOD Modulation	Modulation mode switching	PCM *	PCM/PPM	* Factory setting P.28
BUZZ Buzzer volume switching	Buzzer Volume Switch	Low	Low, HI, OFF	P.29
SRVO Servo operation amount	—	—	—	Servo operation status display for each CH P.29
ALL CLR All clear	—	—	—	Model data reset P.30
COP Model copy	—	—	—	Model memory contents copy P.30
SEL Model select	—	—	—	Model selection P.31
RCL Model recovery	—	—	—	Recovery to before editing P.31
AL Stopwatch	Alarm time	5 minutes	1, 2, 3, 4, 5, 6, 7, 8, 9, 10 15, 20, 30, 40, 50, 60min	Total time Lap time } counting Number of laps P.32

● SERVO EXPLODED VIEW

FP-S9401

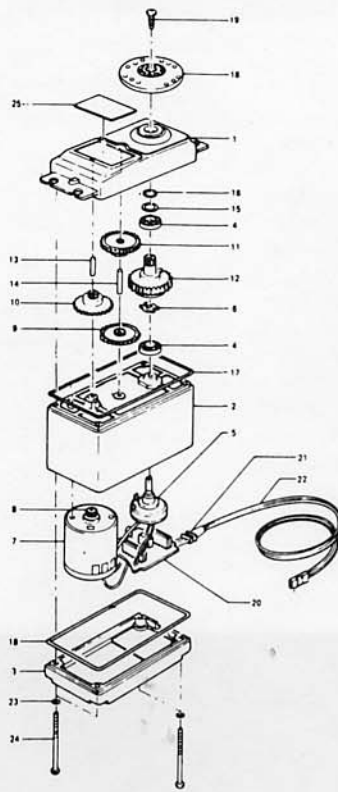

No.	Part name	Part No.
1	Upper case	S05770
2	Middle case	S05780
3	Bottom case	S05790
4	Ball bearing L1060	S04130
5	Potentiometer	I39995
6	VR drive plate	S02753
7	Coreless motor	S91268
8	Pinion gear	S02605
9	1st gear	S02780
10	2nd gear	S02471
11	3rd gear	S02807
12	Final gear	S02809
13	2nd shaft	S01351
14	Intermediate shaft	S04287
15	Spacer washer	S02486
16	Seal ring	S09415
17	O-ring	S90417
18	Splined horn D	S01239
19	Binding head tapping screw 2.6x10 blank	J55204
20	S9401 AMP, S150	AS1340
21	Grommet	S90045
22	3PBG-WRB-300	AT2238
23	O-ring for 1.6φ screw	S90410
24	Phillips panhead screw 2x27.5	J50085
25	S9401 nameplate	S60192

FP-S9302

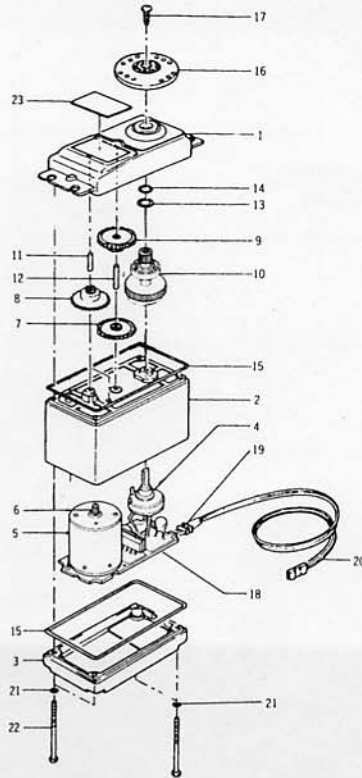

No.	Part name	Part No.
1	Upper case	S06105
2	Middle case	S06106
3	Bottom case	S05790
4	Potentiometer	I39668
5	Coreless motor	S91261
6	Pinion gear	S05530
7	1st gear	S02751
8	2nd gear	S03281
9	3rd gear	S03282
10	Final gear	S02879
11	2nd shaft	S01351
12	Intermediate shaft	S04287
13	Spacer washer	S02486
14	Seal ring	S90415
15	O-ring	S90417
16	Splined horn D	S01239
17	Binding screw	J98707
18	S9302-AMP,S189	AS1350
19	Grommet	S90045
20	3PBG-WRB300G	AT2454
21	O-ring for 1.6φ screw	S90410
22	Phillips pan head screw 2x32	J50091
23	S9302 nameplate	S89077

FP-S9601

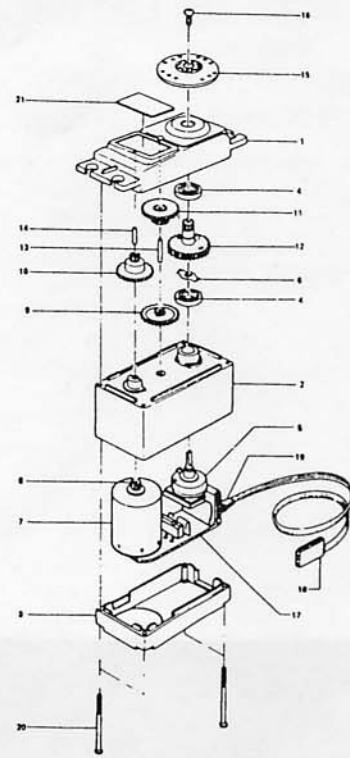

No.	Part name	Part No.
1	Upper case	S05970
2	Middle case	S05980
3	Bottom case	S05990
4	Bearing L1060	S04130
5	Potentiometer	I39665
6	VR drive plate	S05625
7	Motor	S91266
8	Motor pinion	S05532
9	1st gear	S02761
10	2nd gear	S02762
11	3rd gear	S02763
12	Final gear	S02764
13	Intermediate shaft	S04285
14	2nd shaft	S02767
15	Splined horn D	S01239
16	Binding head tapping screw 2.6x8	J55178
17	S9601 AMP,	AS1317
18	3PD-WRB-170B	AL0705
19	Grommet	S90045
20	No. 0 type 3 pan head screw M1.7x24	J40070
21	S9601 nameplate	S60193

• NOMENCLATURE

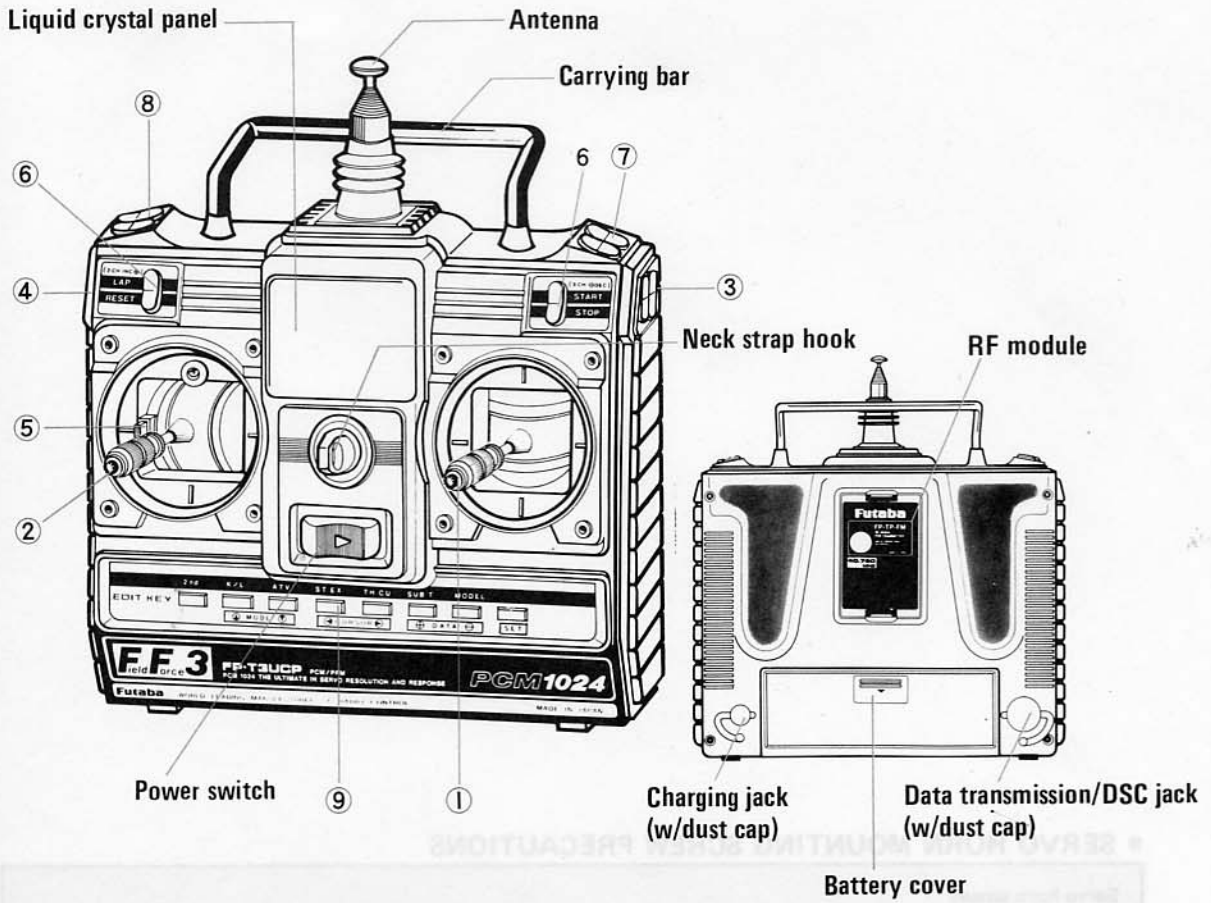

①	Steering stick	
②	Throttle stick	
③	Steering one-touch trim	*
④	Throttle one-touch trim	*
⑤	Neutral adjuster	
⑥	Stopwatch/CH3 one-touch trim	*
⑦	Steering D/R one-touch button	*
⑧	Throttle ATL one-touch button	*
⑨	Edit key	

*Remerk:
Initial position of One-touch-button shows INITIAL-POSITION. Function ATLP (ATL-POSITION) set positions required.

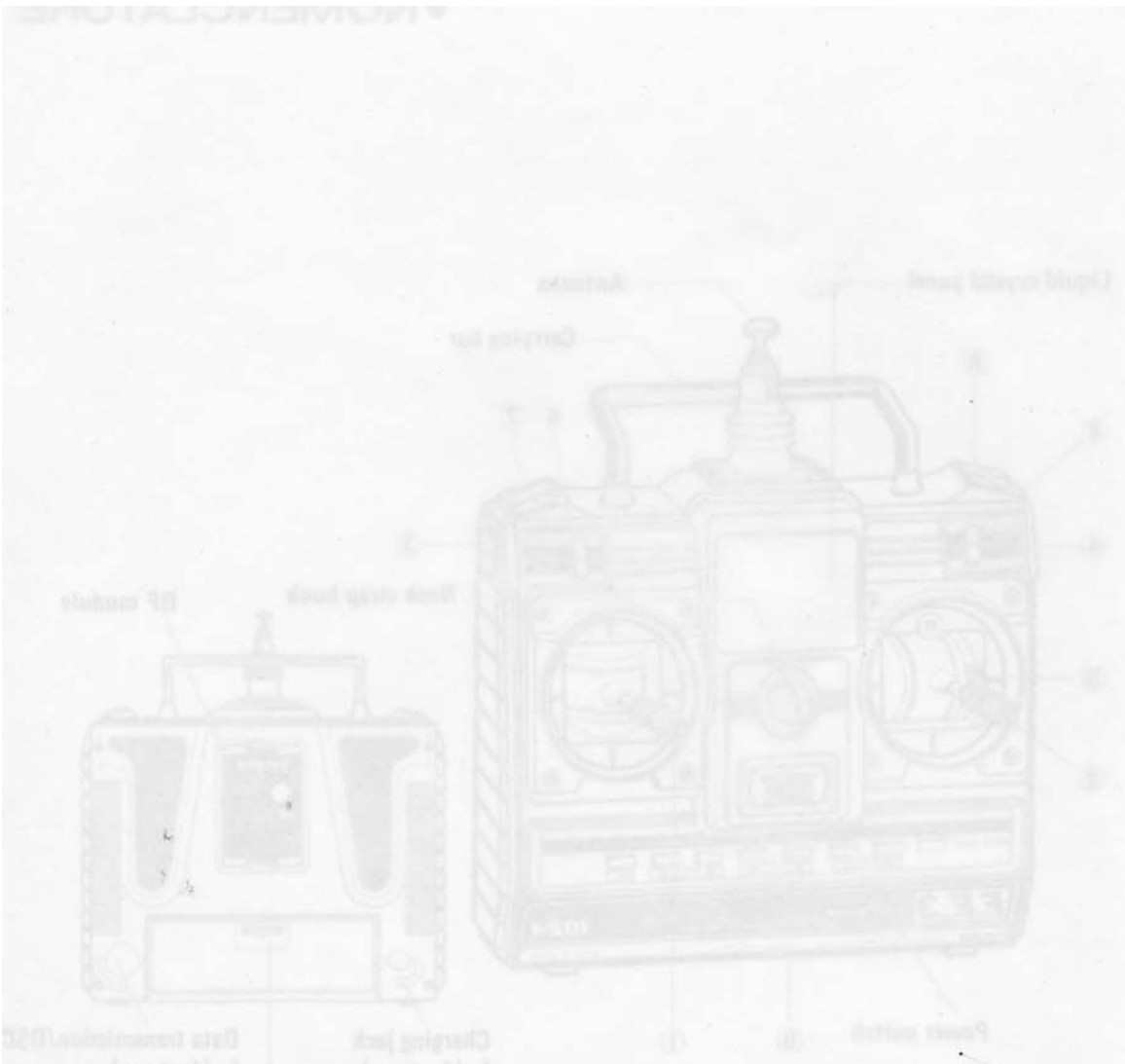

■ SERVO HORN MOUNTING SCREW PRECAUTIONS

Servo horn screws				
Horn mounting screw Size	Type	Applicable servo	Type	Dimensions (mm)
2.6x6	tapping	S133, S143 series	B	5.7
2.6x8	tapping	S129 series	A	7.9
		S130 series, S9101, S5101		
		S128 series	B	11.9
		S132 series	B	7.3
		S135 series, S9601	B	8.7
2.6x10	tapping	S138 series	B	9.9
		S148 series	B	10.5
2.6x12	tapping	S131S series, S136G, S9201, S9301, S9401	A	9.0
2.6x12	tapping	S134 series, S3301	A	11.3
2.6x5		S3002	B	10.0
		S3302	A	5.0
		S5102	A	5.5
		S9302	A	9.0

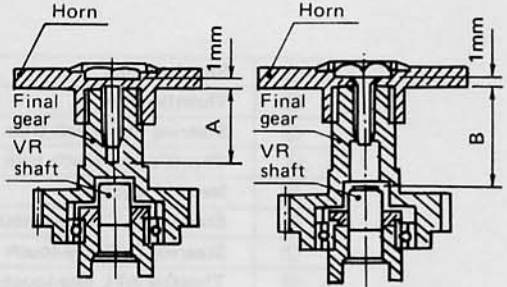

Waterproof type A Non-waterproof type B

Note:

- If screws longer than necessary are used, the final gear may be broken or the potentiometer may be damaged or may fall out.

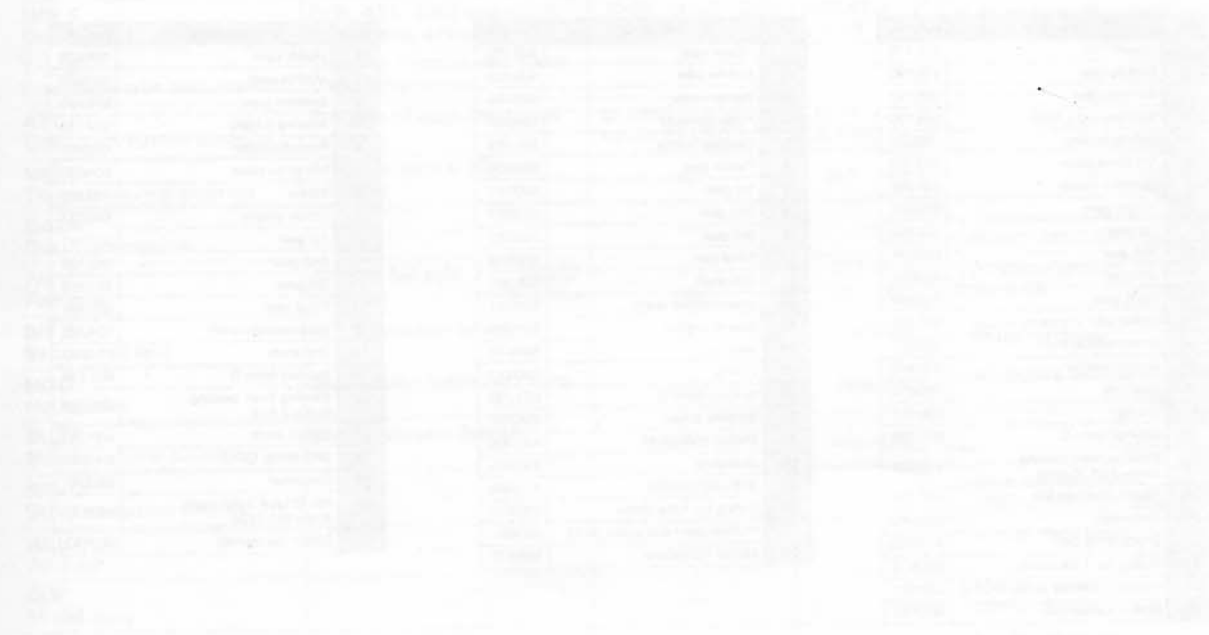



FUTABA CORPORATION
 Makuhari Techno Garden Bldg., B6F 1-3 Nakase, Mihama-ku, Chiba 261-01, Japan
 Overseas Marketing & Sales Radio Control Systems
 Phone: (043) 296-5119 Facsimile: (043) 296-5124

FUTABA CORPORATION OF AMERICA
 4 Studebaker, Irvine California 92718, U.S.A.
 Phone: 714-455-9888 Facsimile: 714-455-9899