

Thank you for purchasing a Futaba 4GWD.
Before using your 4GWD, read this manual carefully and use your R/C set safely.
After reading this manual, store it in a safe place.

Application, Export, and Modification

1. This product may be used for models only. It is not intended for use in any application other than the control of models for hobby and recreational purposes. The product is subject to regulations of the Ministry of Radio/Telecommunications and is restricted under Japanese law to such purposes.
2. Exportation precautions:
 - (a) When this product is exported from the country of manufacture, its use is to be approved by the laws governing the country of destination which govern devices that emit radio frequencies. If this product is then re-exported to other countries, it may be subject to restrictions on such export. Prior approval of the appropriate government authorities may be required. If you have purchased this product from an exporter outside your country, and not the authorized Futaba distributor in your country, please contact the seller immediately to determine if such export regulations have been met.
 - (b) Use of this product with other than models may be restricted by Export and Trade Control Regulations, and an application for export approval must be submitted. In the US, use of 72MHz (aircraft only), 75MHz (ground models only) and 27MHz (both) frequency bands are strictly regulated by the FCC. This equipment must not be utilized to operate equipment other than radio controlled models. Similarly, other frequencies (except 50MHz, for HAM operators) must not be used to operate models.
3. Modification, adjustment, and replacement of parts: Futaba is not responsible for unauthorized modification, adjustment, and replacement of parts on this product. Any such changes may void the warranty.

Compliance Information Statement (for U.S.A.)

This device, trade name Futaba Corporation of America, model number R124H complies with part 15 of the FCC Rules. Operation is subject to the following two conditions:

- (1) This device may not cause harmful interference, and
- (2) This device must accept any interference received, including interference that may cause undesired operation.

The responsible party of this device compliance is;

Futaba Service Center

3002 N Apollo Drive Suite 1, Champaign, IL 61822 U.S.A.

TEL (217)398-8970 or E-mail: support@futaba-rc.com (Support)

TEL (217)398-0007 or E-mail: service@futaba-rc.com (Service)

Battery Recycling (for U.S.A.)



The RBRC™ SEAL on the (easily removable) nickel-cadmium battery contained in Futaba products indicates that Futaba Corporation of America is voluntarily participating in an industry program to collect and recycle these batteries at the end of their useful lives, when taken out of service within the United States. The RBRC™ program provides a convenient alternative to placing used nickel-cadmium batteries into the trash or municipal waste system, which is illegal in some areas.

You may contact your local recycling center for information on where to return the spent battery. Please call 1-800-8-BATTERY for information on Ni-Cd battery recycling in your area. Futaba Corporation of America's involvement in this program is part of its commitment to protecting our environment and conserving natural resources.

RBRC™ is a trademark of the Rechargeable Battery Recycling Corporation.

Warning: This product contains a chemical known to cause cancer and birth defects (or other reproductive harm).

-
- No part of this manual may be reproduced in any form without prior permission.
 - The contents of this manual are subject to change without prior notice.
 - This manual has been carefully written. Please write to Futaba if you feel that any corrections or clarifications should be made.
 - Futaba is not responsible for the use of this product.

Table Of Contents

For Your Safety As Well As That Of Others 6

Explanation of Symbols.....	6
Operation Precautions.....	6
NiCd Battery Handling Precautions.....	8
Storage and Disposal Precautions	9
Other Precautions	10

Before Using 11

Set Contents	11
Transmitter	12
Digital Trim Operation (DT1/DT2/DT3/DT4)	13
Stick Lever Head Adjustment	14
Modification To Ratchet System	14
Battery Replacement (for dry cell battery system)	15
Charging The Battery (for NiCd battery system)	16
Set Data Backup	17
Receiver	18
Servo	18
E.S.C.	18

Installation 19

Receiver and Servo Connections	19
Installation Safety Precautions	20

Initial Set-Up 21

Preparations	21
Display when power switch is turned on.....	21
Digital Trims Initial Set-Up	21
Set-Up Procedure When Installed In a Car	21
MC230CR Set-Up Procedure.....	22

Function Map 23

(Function Selection)	23
----------------------------	----

Functions 24

End Point Adjuster / EPA	24
Subtrim / SBT	26

Servo Reverse / REV	27
Model Select / SEL	28
Model Copy / CPY	29
Model Reset / CLR	30
Model Name / NAM	31
MC230CR Function	32

**For Your Safety
As Well As
That Of Others**

Reference 33

Ratings	33
Optional Parts	34
Troubleshooting	35
Error Displays	36
When requesting repair	37

**Before
Using**

Installation

**Initial
Set-Up**

**Function
Map**

Functions



Reference

For Your Safety As Well As That Of Others

Use this product in a safe manner. Please observe the following safety precautions at all times.

Explanation of Symbols

The parts of this manual indicated by the following symbols are extremely important and must be observed.

Symbols	Explanation
 Danger	Indicates a procedure which could lead to a dangerous situation and may cause death or serious injury if ignored and not performed properly.
 Warning	Indicates procedures which may lead to dangerous situations and could cause death or serious injury as well as superficial injury and physical damage.
 Caution	Indicates procedures that may not cause serious injury, but could lead to physical damage.

Symbols:  ; Prohibited,  ; Mandatory

Operation Precautions

Warning

Prohibited Procedures

 Do not operate two or more models on the same frequency at the same time.

Operating two or more models at same time on the same frequency will cause interference and loss of control of both models.

AM, FM (PPM) PCM and HRS are different methods of modulation. Nonetheless the same frequency can not be used at the same point in time, regardless of the signal format.

 Do not operate outdoors on rainy days, run through puddles of water or when visibility is limited.

Should any type of moisture (water or snow) enter any component of the system, erratic operation and loss of control may occur.

 Do not operate in the following places.

- Near other sites where other radio control activity may occur.
- Near people or roads.
- On any pond when boats are present.
- Near high tension power lines or communication broadcasting antennas.

Interference could cause loss of control. Improper installation of your Radio Control System in your model could result in serious injury.

 Do not operate this R/C system when you are tired, not feeling well or under the influence of alcohol or drugs.

Your judgment is impaired and could result in a dangerous situation that may cause serious injury to yourself as well as others.

Mandatory Procedures

- ! Extend the transmitter antenna to its full length.

If the transmitter antenna is not fully extended the operating range of the radio will be reduced.

- ! Check the transmitter antenna to be sure it is not loose.

If the transmitter antenna works loose, or is disconnected while the model is running signal transmission will be lost. This will cause you to lose control of the model.

- ! Always perform an operating range check prior to use.

Problems with the radio control system as well as improper installation in a model could cause loss of control.

Simple range test method:

Have a friend hold the model, or clamp it down or place it where the wheels or prop can not come in contact with any object. Walk away and check to see if the servos follow the movement of the controls on the transmitter. Should you notice any abnormal operation, do not operate the model. Also check to be sure the model memory matches the model in use.

Caution

Prohibited Procedures

- ⊘ Do not touch the engine, motor, speed control or any part of the model that will generate heat while the model is operating or immediately after its use.

These parts may be very hot and can cause serious burns.

Mandatory Procedures

(Turning on the power switches)

- ! Always check the throttle stick on the transmitter to be sure it is at the neutral position.

1. Turn on the transmitter power switch.
2. Turn on the receiver or speed control power switch.

(Turning off the power switches)

- ! Always be sure the engine is not running or the motor is stopped.

1. Turn off the receiver or speed control power switch.
2. Then turn off the transmitter power switch.

If the power switches are turned off in the opposite order the model may unexpectedly run out of control and cause a very dangerous situation.

- ! When making adjustments to the model do so with the engine not running or the motor disconnected.

You may unexpectedly lose control and create a dangerous situation.

- ! When operating your model always display a frequency flag on your transmitter antenna.

- ! When placing the transmitter on the ground during flight preparations, be sure that the wind cannot knock it over.

If it is knocked over, the throttle stick may be pushed to full high and the engine will race and create a dangerous situation.

NiCd Battery Handling Precautions

(Only when NiCd batteries are used)

For Your Safety As Well As That Of Others

Warning

Mandatory Procedures

! Always check to be sure your batteries have been charged prior to operating the model.

Should the battery go dead while the model is operating, loss of control will occur and create a very dangerous situation.

! When the model is not being used, always remove or disconnect the NiCd battery.

Should the battery be left connected this could create a dangerous situation if someone accidentally turns on the receiver power switch. Loss of control would occur.

! To recharge the transmitter NiCd, use the special charger made for this purpose.

Overcharging could cause the NiCd battery to overheat, leak or explode. This may lead to fire, burns, loss of sight and many other types of injuries.

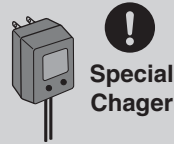

Caution

Prohibited Procedures

⊘ Do not use commercial AA size NiCd batteries.

Quick charging may cause the battery contacts to overheat and damage the battery holder.



⊘ Do not short circuit the NiCd battery terminals.

Causing a short circuit across the battery terminals may cause abnormal heating, fire and burns.

⊘ Do not drop the NiCd battery or expose it to strong shocks or vibrations.

The battery may short circuit and overheat, electrolyte may leak out and cause burns or chemical damage.



Storage and Disposal Precautions

Warning

— Prohibited Procedures —

 Do not leave the radio system or models within the reach of small children.

A small child may accidentally operate the system. This could cause a dangerous situation and injuries. NiCd batteries can be very dangerous when mishandled and cause chemical damage.

 Do not throw NiCd batteries into a fire. Do not expose NiCd batteries to extreme heat. Also do not disassemble or modify a NiCd battery pack.

Overheating and breakage will cause the electrolyte to leak from the cells and cause skin burns, loss of sight as well as other injuries.

— Mandatory Procedures —

 When the system will not be used for any length of time store the system with batteries in a discharged state. Be sure to recharge the batteries prior to the next time the system is used.

If the batteries are repeatedly recharged in a slightly discharged state the memory effect of the NiCd battery may considerably reduce the capacity. A reduction in operating time will occur even when the batteries are charged for the recommended time.

<NiCd Battery Electrolyte>

The electrolyte in NiCd batteries is a strong alkali. Should you get even the smallest amount of the electrolyte in your eyes, DO NOT RUB. Wash immediately with water and seek medical attention at once. The electrolyte can cause blindness. If electrolyte comes in contact with your skin or clothes, wash with water immediately.

Caution

— Prohibited Procedures —

 Do not store your R/C system in the following places.

- Where it is extremely hot or cold.
- Where the system will be exposed to direct sunlight.
- Where the humidity is high.
- Where vibration is prevalent.
- Where dust is prevalent.
- Where the system would be exposed to steam and condensation.

Storing your R/C system under adverse conditions could cause deformation and numerous problems with operations.

— Mandatory Procedures —

 If the system will not be used for a long period of time remove the batteries from the transmitter and model and store in a cool dry place.

If the batteries are left in the transmitter electrolyte may leak and damage the transmitter. This applies to the model also. Remove the batteries from it also to prevent damage.

<NiCd Battery Recycling>

A used NiCd battery is valuable resource. Insulate the battery terminals and dispose the battery by taking it to a battery recycling center.

Other Precautions

Caution

— Prohibited Procedures —

-  Do not expose plastic parts to fuel, motor spray, waste oil or exhaust.

The fuel, motor spray, waste oil and exhaust will penetrate and damage the plastic.

— Mandatory Procedures —

-  Always use only genuine Futaba transmitters, receivers, servos, FET amps (electronic speed controls), NiCd batteries and other optional accessories.

Futaba will not be responsible for problems caused by the use of other than Futaba genuine parts. Use the parts specified in the instruction manual and catalog.

Before Using

Set Contents

After opening the box, first check if the contents conform to the following. The contents depend on the set as shown below.

Transmitter	T4GWD	
Receiver	R124H	
Servo	S3003 (x3)	S3003 (x2)
ESC	—	MC230CR
Miscellaneous	Receiver battery holder w/switch	—
	Shift gate Throttle ratchet plate Instruction manual	

If any of the set contents are missing, or you have any questions, please contact the dealer where the unit was purchased.

Caution

 Always use only genuine Futaba transmitter, receiver, servo, NiCd battery and other optional parts.

Futaba will not be responsible for damage caused by other than genuine Futaba parts and components. Use only the genuine Futaba parts and components listed in the instruction manual and catalog.

Transmitter T4GWD

Before Using

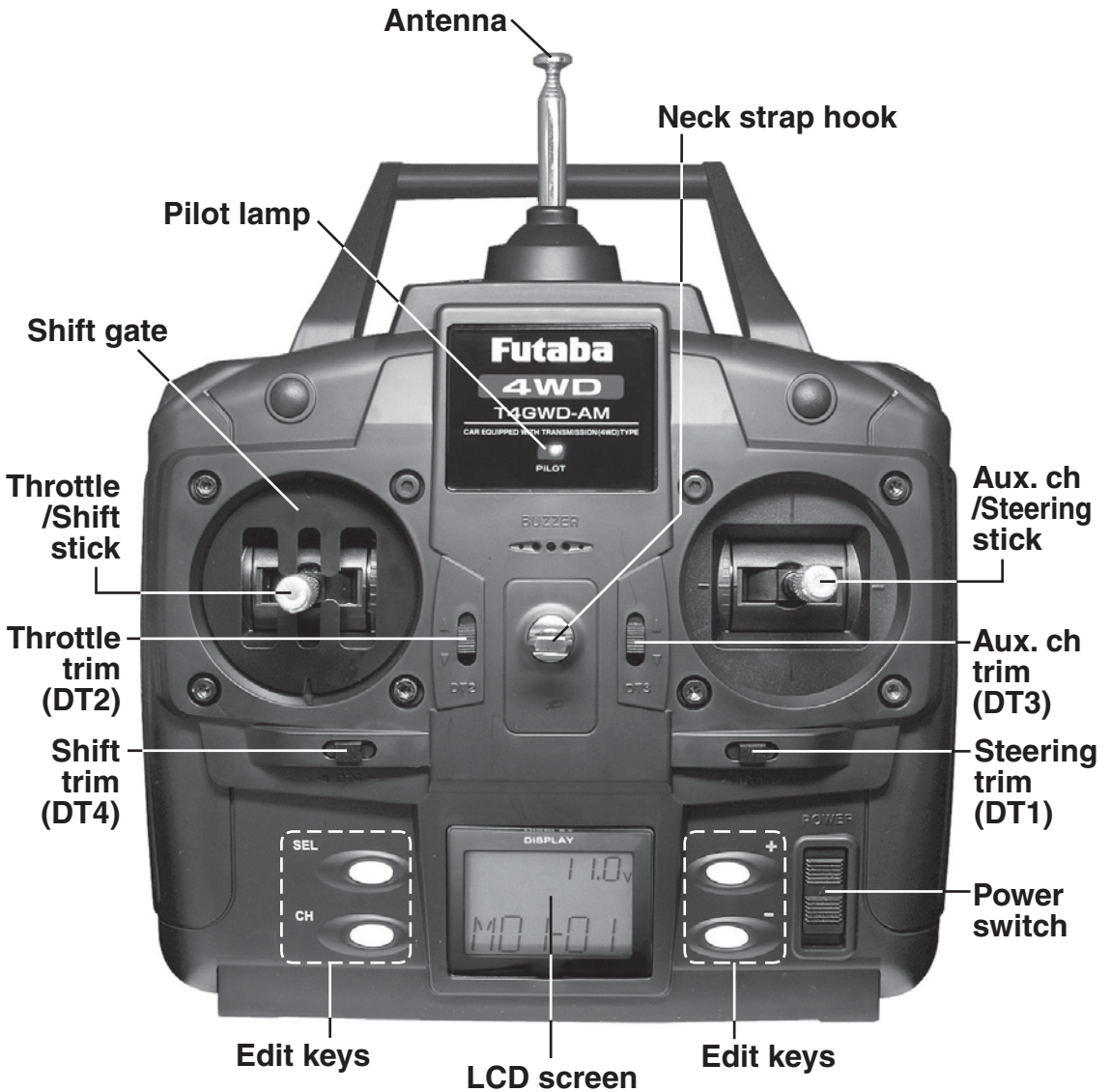

Precautions when turning the power switch on and off.

When the data was changed using the edit keys or trim levers, wait at least two seconds before turning off the power. If the power is turned off within two seconds after the data was changed, the new data will not be written to memory.

Digital Trim Operation (DT1/DT2/DT3/DT4)

Push the lever to the left or right (up or down).

The current position is displayed on the LCD screen for about three seconds when each digital trim is operated.

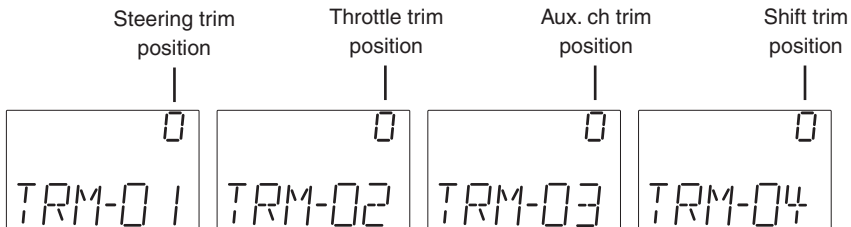
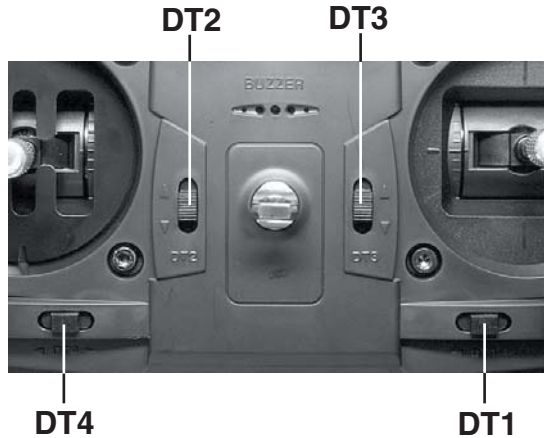

- Each step is indicated by a tone.
- When the trim exceeds the maximum trim adjustment range, the tone will change pitch and the lever will not move any farther.

Trim Operation

With the digital trim feature, trim adjustments have no effect on the maximum servo travel. This prevents the linkages from binding when adjustments are made.

Stick Lever Head Adjustment

The length of the lever head of the steering and throttle sticks can be adjusted.

Adjustment

- 1 Unlock lever head "A" by turning it counterclockwise.
- 2 Adjust the head to the length best for you, then lock the heads by turning lever head "A" clockwise and lever head "B" counterclockwise.

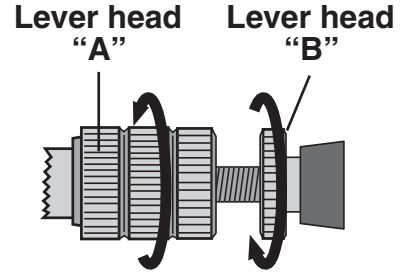

Modification To Ratchet System

When modifying the throttle stick from self-neutral system (factory installation) to ratchet system, use the accessory parts to change the system.

Modification

- 1 Turn off the power to the transmitter.
- 2 Remove the four transmitter rear case screws and remove the rear case.
- 3 Disconnect the battery connector.
- 4 Remove the swing arm and spring. This frees the throttle stick.
- 5 Install the accessory ratchet plate with the screw.
- 6 At the end of modification, connect the battery connector and close the rear case.

Swing arm and spring



Ratchet plate and screw

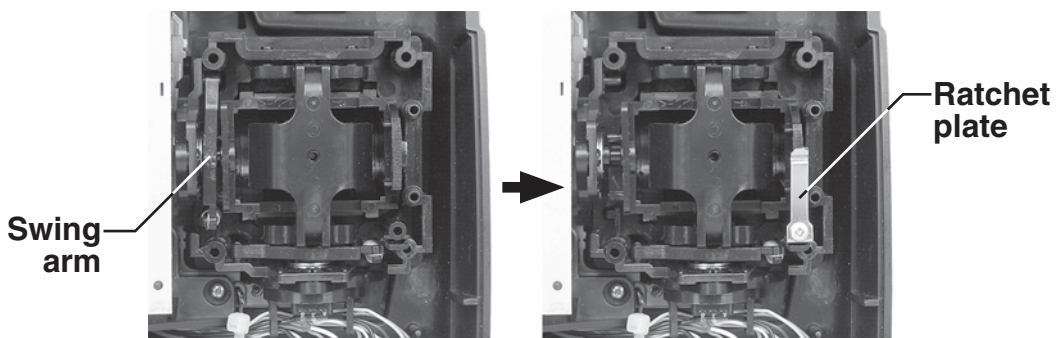

Battery Replacement (for dry cell battery system)

Load the eight batteries in accordance with the polarity markings on the battery holder. (8 AA Size Batteries)

Battery Replacement

1 Remove the battery cover from the transmitter by sliding it in the direction of the arrow in the figure.

2 Remove the used batteries.

3 Load the new AA size batteries. Pay very close attention to the polarity markings and reinsert accordingly.

4 Slide the battery cover back onto the case.

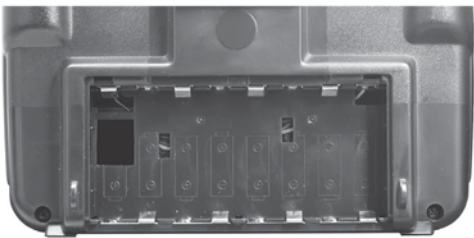
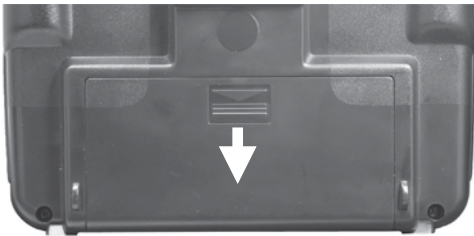

⚠ Caution

⚠ Always be sure you reinsert the batteries in the correct polarity order.

If the batteries are loaded incorrectly, the transmitter may be damaged.

⚠ When the transmitter will not be used for any short or long period of time, always remove the batteries.

If the batteries do happen to leak, clean the battery case and contacts thoroughly. Make sure the contacts are free of corrosion.

Check:

Turn the power switch on the transmitter to the ON position. Check the battery voltage display on the LCD screen.

If the voltage is low, check the batteries for insufficient contact in the case or incorrect battery polarity.

Low Battery Alarm:

If the transmitter battery voltage drops below 8.5V an alarm will sound and "LOW BT" will be displayed on the LCD screen.

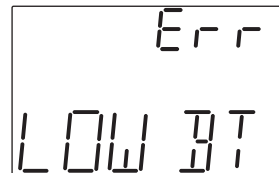

The low battery alarm is meant to be a safety feature only. Do NOT operate your radio below 9V. Always shut your radio off as soon as possible after the low battery warning tone to avoid loss of control.

Charging The Battery (for NiCd battery system)



Charging jack



NiCd battery
NT8F700B

- Always use an NT8F700B NiCd battery.

Charging the NiCd Battery

- 1** Plug the transmitter cord of the special charger into the charging jack on the side of the transmitter.
- 2** Plug the charger into an AC outlet.
- 3** Check that the charging LED lights.

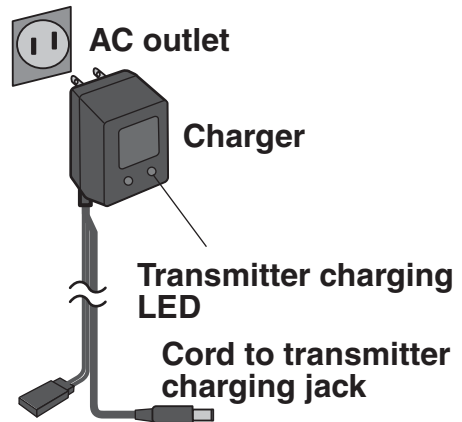

When charging the NT8F700B NiCd battery with the special charger, allow about 15 hours for charging. If the transmitter has not been used for some time, cycle the battery by charging and discharging it two or three times.

Warning

 Never plug it into an outlet other than indicated voltage.

Plugging the charger into the wrong outlet may result in an explosion, sparking, or fire.

 Do not insert and remove the charger when your hands are wet.

It may cause an electric shock.

 Always use the special charger or a quick charger for digital proportional R/C sets to charge a digital proportional R/C set NiCd battery.

Overcharging a NiCd battery can result in burns, fire, injuries, or loss of sight due to overheating, breakage, or electrolyte leakage.

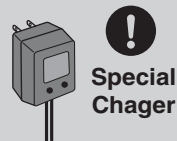

Caution



Never try to recharge a dry cell battery.

The transmitter may be damaged or the battery electrolyte may leak or the battery may break.



When the charger is not in use, disconnect it from the AC outlet.

Do this to prevent accidents and to avoid overheating.

Set Data Backup

The set data of each function of the T4GWD transmitter is stored in a memory element that does not require a backup battery. Therefore, the T4GWD transmitter can be used without paying attention to the backup battery life.

Receiver

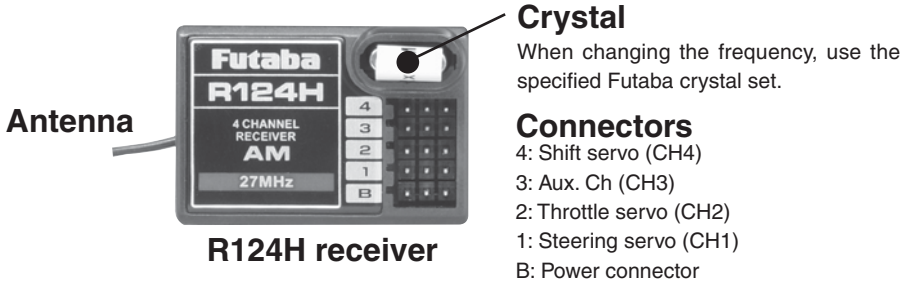

For the receiver, servos, and other connections, see page 19.
For the installation precautions, see page 20.

Before Using

Servo

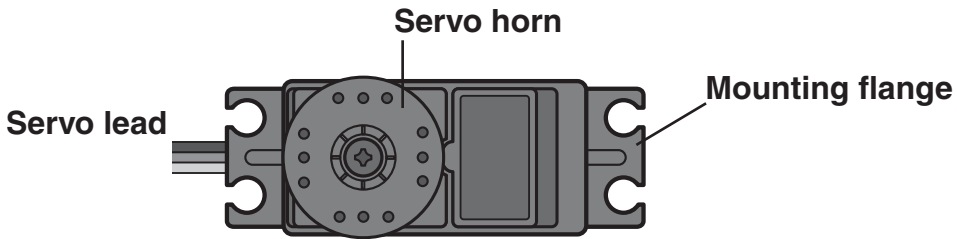

For the receiver, servos, and other connections, see page 19.
For the installation precautions, see page 20.

E.S.C.

Applicable motors (Number of turns is criteria.)

•Use the MC230CR with a motor with 20T or more turns.
*If a motor with a number of turns smaller than the above is used, the heat protector and overcurrent protection circuit may operate. The number of turns of the motor is a criteria only. Depending on the running conditions, the protection circuit may operate even if the condition above is satisfied.

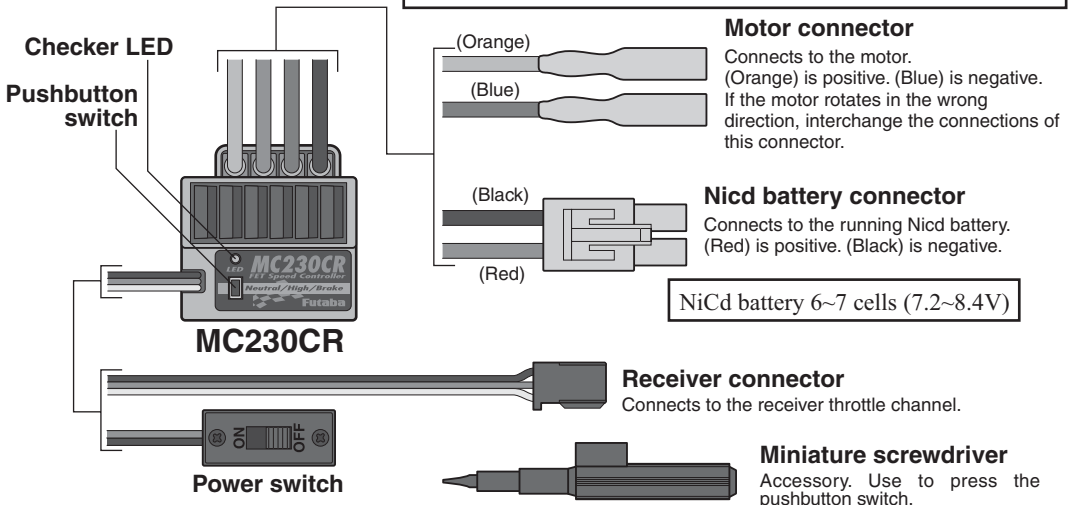

Installation

Receiver and Servo Connections

When connecting and installing the receiver and servos, read the "Installation Safety Precautions" on the next page.

Installation For Gas Powered Models

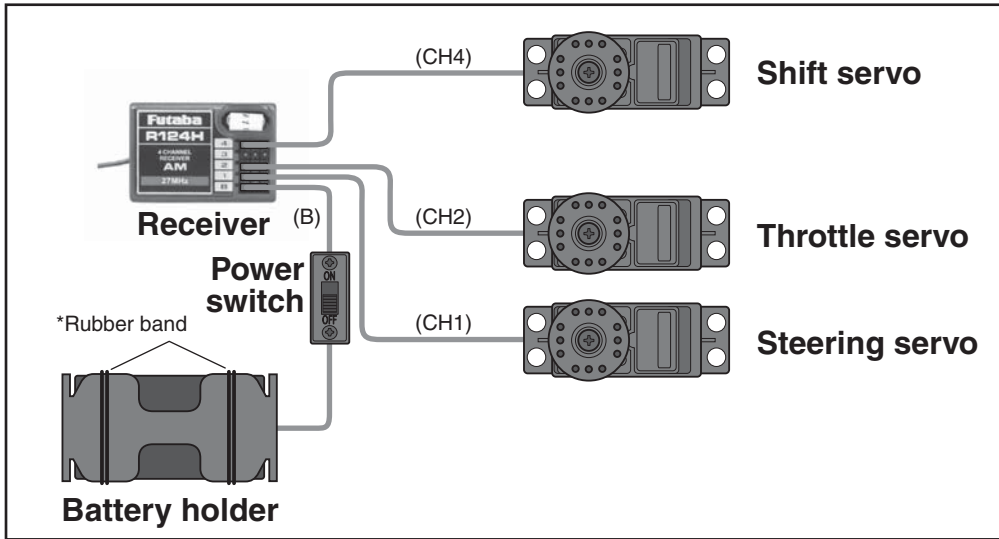

Installation When MC230CR Is Used

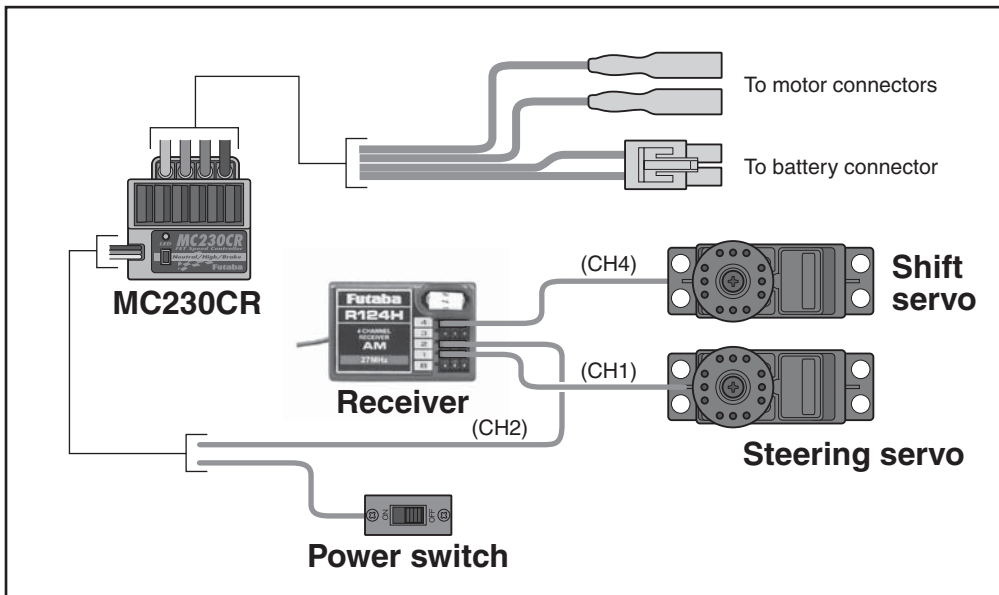

Installation Safety Precautions

Warning

Connector Connections

-  Be sure the receiver, servo, crystal and connectors are fully and firmly connected.

If vibration from the model causes a connector to work loose while the model is in operation, you may lose control.



Receiver Vibration Damping and Waterproofing

-  (Car): Dampen the vibration to the receiver by mounting to the chassis or mounting plate with thick double sided tape in electric powered models. In gas powered models wrap the receiver in foam and mount it where the vibration is the least prevalent.

-  (Boat): Dampen the vibration to the receiver by wrapping it in foam. Waterproof by placing it in a plastic bag or watertight the radio box in your model.

If the receiver is subjected to strong vibration or shock erratic or loss of control may occur. If any moisture comes in contact the receiver and servos you may experience the same result as well as damage to the system.

Receiver Antenna

-  Do not cut or bundle the receiver antenna.
-  Do not bundle the receiver antenna together with the servo lead wires.
-  Keep the receiver antenna at least 1 inch away from the motor and battery and wires that handle heavy current loads.

Cutting, bundling or routing the receiver antenna near any device that produces noise will reduce the operating range of the system and result in loss of control.

Also route the receiver antenna away from metal, carbon fiber and other parts that conduct electricity. These parts can transmit high frequency noise.

Electronic speed control

-  Install the heat sinks where they will not come in contact with aluminum, carbon fiber or other parts that conduct electricity.

If the E.S.C. (Electronic speed control) heat sinks touch other materials that conduct electricity a short circuit could occur. This could result in loss of control and damage to the system.

Servo Throw

-  Operate each servo over its full stroke and be sure the linkage does not bind or is loose.

The continuous application of unreasonable force to a servo may cause damage and excessive battery drain.

Servo Installation

-  When you install the servos always use the rubber grommets provided in servo hardware bags. Mount the servos so they do not directly come in contact with the mount.

If the servo case comes in direct contact with the mount, vibration will be directly transmitted to the servo. If this condition continues for a long time the servo may be damaged and control will be lost.

Motor Noise Suppression

-  Always install capacitors to suppress noise when electric motors are used.

If capacitors are not properly installed you could experience erratic operation and reduced range as well as loss of control.

Other Noise Suppression Methods

-  Be sure there are no metal parts in your model which under vibration could come in contact with other metal parts.

Metal to metal contacts under vibration will emit a high frequency noise that will affect the receiver's performance. You could experience erratic operation and reduced range as well as loss of control.

Initial Set-Up

Preparations

Before setting the transmitter functions, check and set items below:

Display when power switch is turned on

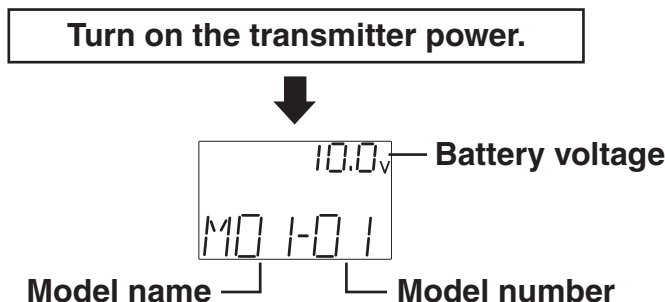

Digital Trims Initial Set-Up

Operate the DT1-DT4 levers and check if each trim value on the screen changes. After checking each trim, set the trim value to the center (0) position.

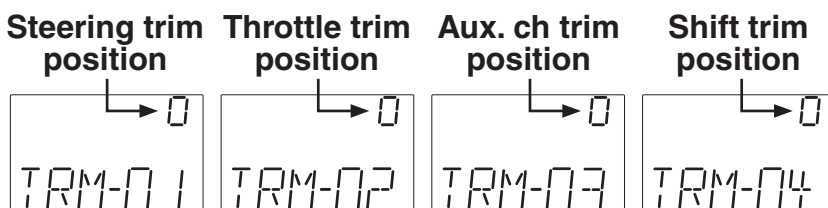

Set-Up Procedure When Installed In a Car

When installing the servos in a car, performing function set-up in the following order is recommended.

1 Set up the servo trims: see the above mentioned "Digital Trims Initial Set-Up".

2 Set the servo direction of operation using the Reverse function: see p. 27.

*The servo installation method and linkage direction depend on the kit. Therefore, the servo operation direction may have to be reversed relative to transmitter operation. Before installing the servo, check the operating direction and set it using the Reverse function.

3 Set the subtrim and adjust the servo neutral point: see p. 26.

4 Set EPA of each channel and adjust the servo throw (travel): see p. 24.

MC230CR Set-Up Procedure

NEUTRAL, HIGH, AND BRAKE MAX POINTS SETTINGS

⚠ CAUTION









❗ Set the steering angle adjustment function (EPA) to 100% and the ABS function and acceleration function to OFF using the transmitter throttle channel function.

If the steering angle is too large or the ABS and acceleration functions are on, erroneous operation may occur.

*When using the ABS function, after setting up the MC230CR, stop the reverse function, then turn on the ABS function. If the ABS function is on, the MC230CR cannot be set up correctly.

Before setting each point, set the transmitter throttle channel trim to neutral.

1 Turn on the power in transmitter -> amp order.

	Transmitter throttle operation	MC230CR	
		(Pushbutton switch operation)	(Checker LED)
2 Neutral point setting	· Neutral state	 · Press the pushbutton switch. (0.5 secs or longer) (Confirmation beep sounds)	 · Continuous single blink 
3 High point setting	· Full high state	 · Press the pushbutton switch. (Confirmation beep sounds)	 · Continuous double blink 
4 Brake MAX point setting	· Full brake state	 · Press the pushbutton switch. (Confirmation beep sounds.)	 · If the LED goes out, setting is complete.

If the LED does not go off but blinks rapidly, setting was not performed normally. Repeat setting from 'Neutral point setting'.

 · Continuous rapid blink

* Since the data is read at the end of setting of all points, the points cannot be set independently.

* If the amp power was turned off during setting, the setting points cannot be memorized. (The previous settings are retained.)

* The confirmation beep sounds only when the motor was connected.

Function Map

Power switch turned on

Press "SEL" key to select the desired function screen.
Press it for one second or more to scroll to the opposite direction.

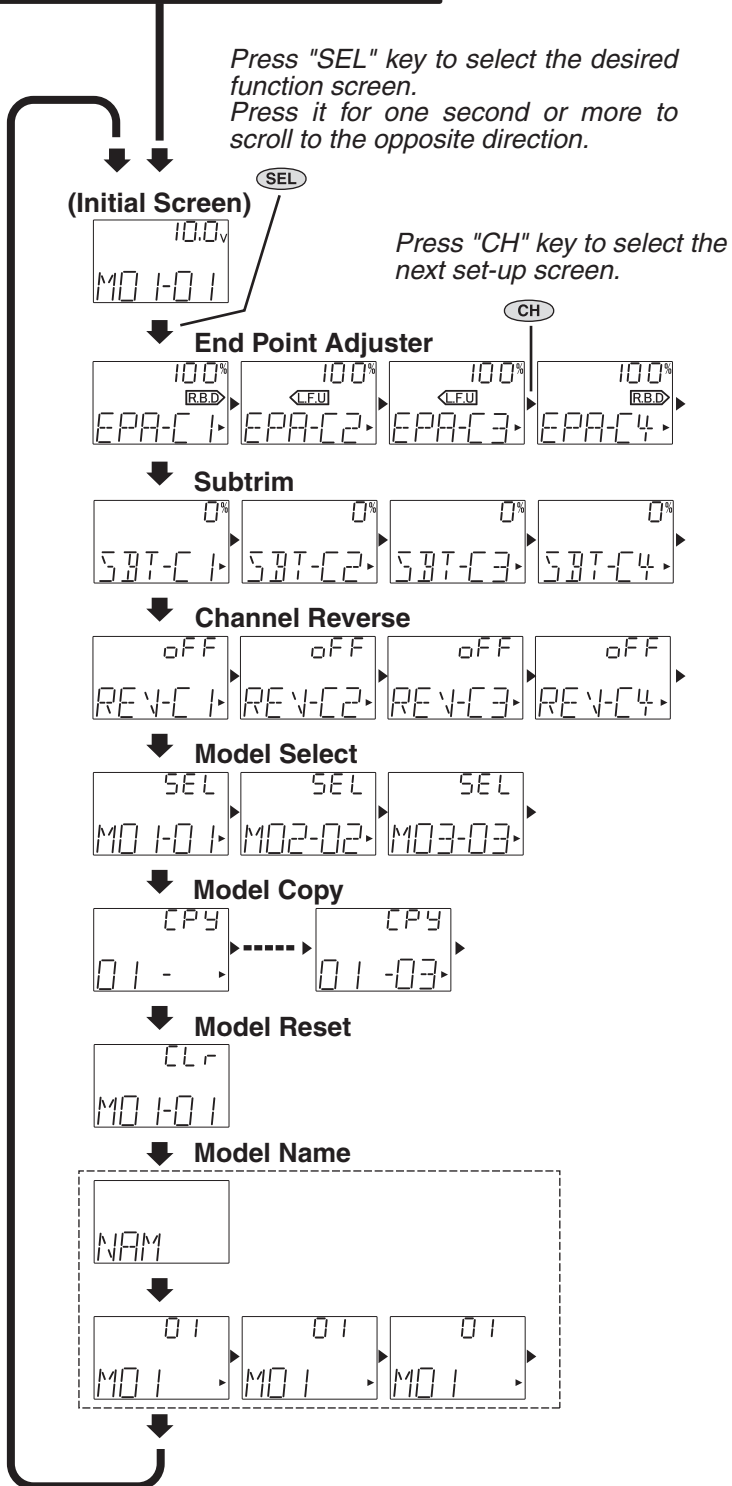

Functions

End point adjuster/EPA

Use this when performing left and right steering angle adjustments, throttle high side/brake side operation amount adjustment, channel 3 servo up side/down side operation amount adjustment, and shift servo left side/right side operation amount adjustments during linkage.

- Corrects the maximum steering angle and left and right steering angles when there is a difference in the turning radius due to the characteristics, etc. of the vehicle.

Maximum steering angle

The EPA function basically determines the maximum steering angle of each channel. The Sub trim function may have been adjusted, or the operating range set by EPA function may be exceeded. Check the linkage each time the Sub trim function is adjusted.

Warning

-  Make sure that unreasonable force is not applied to the servo horn during each channel operation.

If unreasonable force is applied to the servo horn, the servo may malfunction and the model may run out of control.

Calling the setup screen

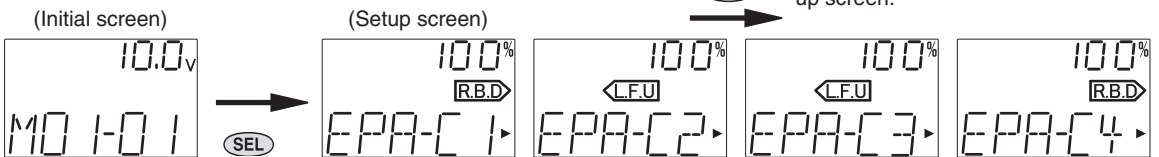

Press "SEL" key to select the desired function screen.

[Setup items]

- C1-L.F.U : Steering (left side)
- C1-R.B.D : Steering (right side)
- C2-L.F.U : Throttle (forward side)
- C2-R.B.D : Throttle (brake side)
- C3-L.F.U : 3rd channel (up side)
- C3-R.B.D : 3rd channel (down side)
- C4-L.F.U : Shift (left side)
- C4-R.B.D : Shift (right side)

[Adjustment range]

0~120% (each channel, each direction)
Initial value: 100%

[Adjustment buttons]

- Use the (+) and (-) keys to make adjustments.

- Return to the initial value by pressing the (+) and (-) buttons simultaneously (approx. 1 sec).

Steering (EPA) adjustment

(Preparation)

- Select setup item "C1" and make the following adjustments:

1 Steering (left side) adjustment

Turn the steering stick fully to the left and use the (+) and (-) buttons to adjust the steering angle.

2 Steering (right side) adjustment

Turn the steering stick fully to the right and use the (+) and (-) buttons to adjust the steering angle.

3 When adjusting the EPA of another channel immediately after this, select the setup item ("C2", "C3" or "C4") and then adjust the operation amount.

When ending adjustment, return to the initial screen by pressing the (SEL) button.

Throttle (EPA) adjustment

(Preparation)

- Select setup item "C2" and make the following adjustments:

1 Throttle (forward side) adjustment

Push the throttle stick fully to the high side and use the (+) and (-) buttons to adjust the operation amount. However, when using an ESC, set to 100%.

2 Throttle (brake side/reverse side) adjustment

Pull the throttle stick fully to the brake side and use the (+) and (-) buttons to adjust the operation amount. However, when using an ESC, set to 100%.

3 When adjusting the EPA of another channel immediately after this, select the setup item ("C1", "C3" or "C4") and then adjust the operation amount.

When ending adjustment, return to the initial screen by pressing the (SEL) button.

Repeat this procedure for the end point settings on the other channel remaining ("C3" and "C4".)

Subtrim / SBT

Use this function to adjust the neutral position of the steering, throttle, channel 3 and shift servos.

Subtrim shifts the entire servo travel range in the set direction.

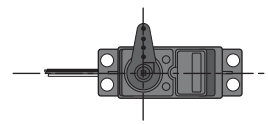

Use to adjust the neutral position

Calling the setup screen

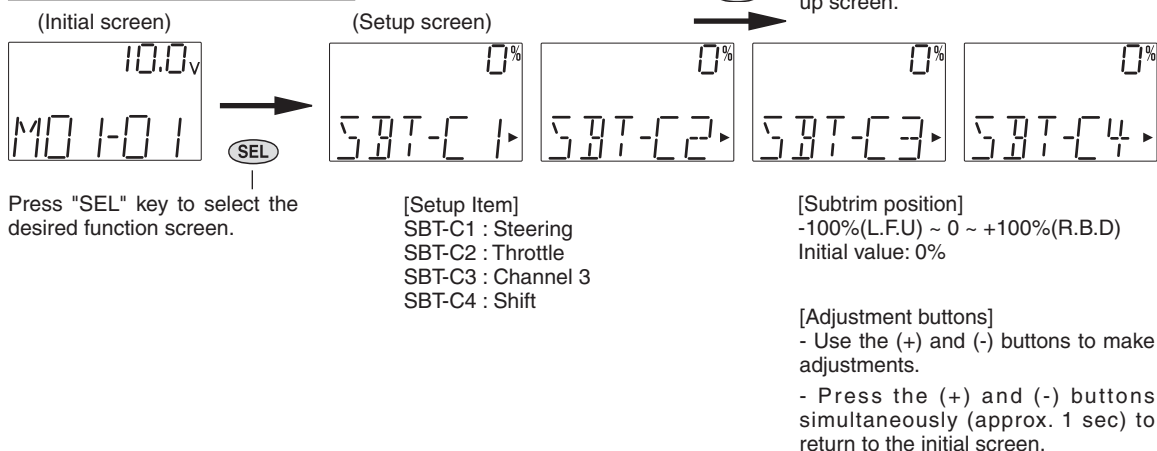

Subtrim adjustment

(Preparation)

-Set the steering, throttle, channel 3, and shift digital trims to the neutral "0" position.

- Preselect setup channel "C1", "C2", "C3" or "C4".

1 (Subtrim adjustment)

Use the (+) or (-) button to adjust the center.

(Each channel can be set similarly.)

2 When ending adjustment, return to the initial screen by pressing the (SEL) button.

Servo Reverse / REV

This function reverses the direction of operation of the servos related to transmitter steering, throttle, channel 3 and shift operation.

However, when the position set by trim or subtrim shifts from the center, the center becomes the opposite side.

Calling the setup screen

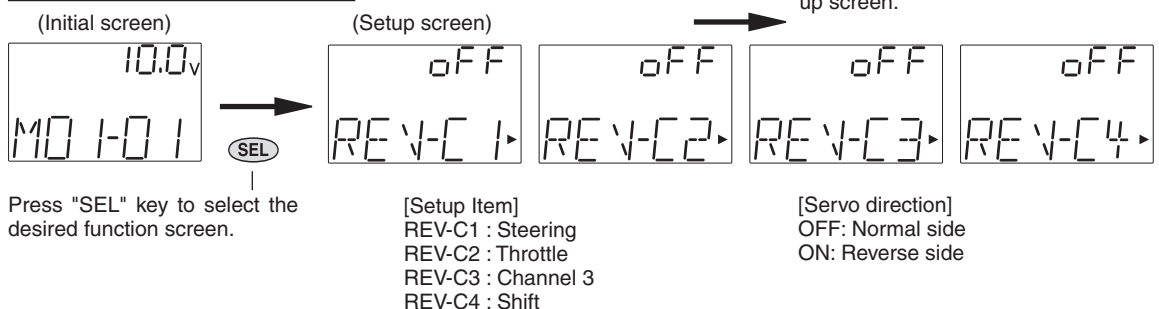

Servo Reverse Function Setting

(Preparation)

- Preselect setup channel "C1", "C2", "C3" or "C4".

1 (Servo reverse setting)

Use the (+) or (-) button to reverse the servo operation direction.

(Each channel can be set similarly.)

2 When ending adjustment, return to the initial screen by pressing the (SEL) button.

Model Select / SEL

Use this function to call a new model number, or to change a set model number, to set new model data. The T4GWD transmitter can store the model data for three R/C cars.

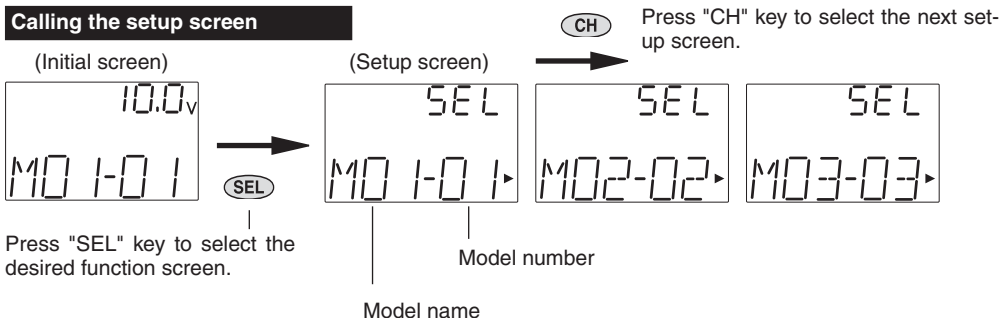

Model Select

- 1** Model No. selection
Use the (CH) button to select the model No.
- 2** Select execution
Press the (+) and (-) buttons simultaneously for about 1 second.
- 3** When ending adjustment, return to the initial screen by pressing the (SEL) button.

Model Copy / CPY

This function copies the entire contents of the currently called model memory to another model memory.

Calling the setup screen

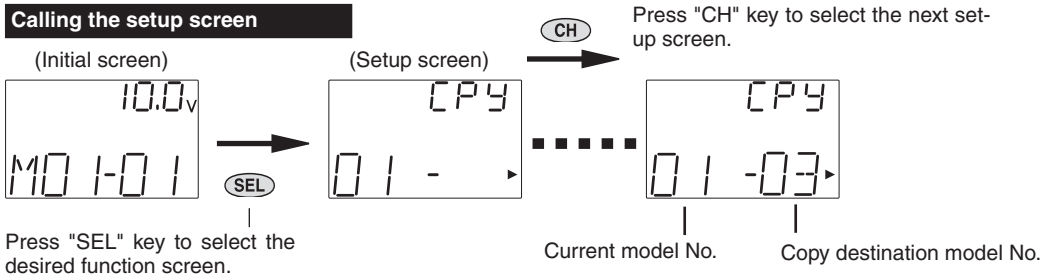

Model Copy

- 1** Copy destination selection
Use the (CH) button to select the copy destination model No.
- 2** Copy execution
Press the (+) and (-) buttons simultaneously for about 1 second.
- 3** When ending model copy, return to the initial screen by pressing the (SEL) button.

Model Reset / CLR

This functions resets the contents of the currently called model memory to the initial value.

Calling the setup screen

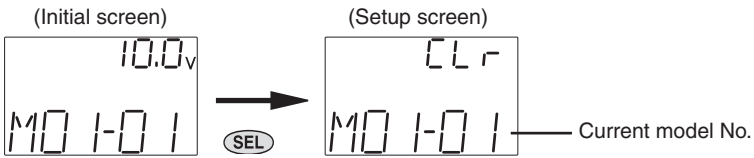

Press "SEL" key to select the desired function screen.

Model Reset

- 1** Reset execution
Press the (+) and (-) buttons simultaneously for about 1 second.
- 2** When ending model reset, return to the initial screen by pressing the (SEL) button.

Model Name / NAM

This function allows you to assign a three character name to each model memory.
(Number and alphabet can be used.)

Calling the setup screen

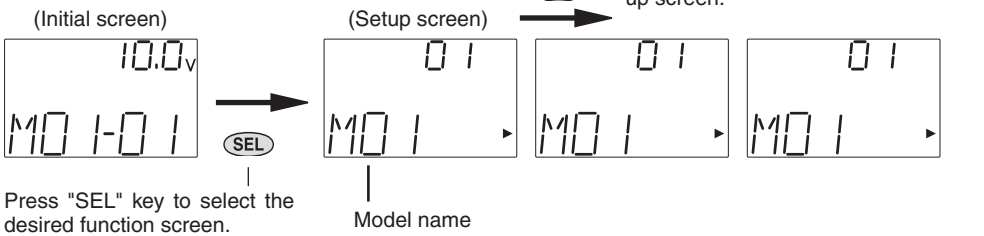

Model Name

- 1** Move the cursor (blinking) to the column you want to change using the (CH) button.
- 2** Change the character using the (+) or (-) button.
(Set the model name by repeating steps 1 and 2 above.)
- 3** When ending model name setting, return to the initial screen by pressing the (SEL) button.

MC230CR Function

CANCELLING THE REVERSE FUNCTION

The amp reverse function can be cancelled by the following method so that the model can be used even in races that prohibit reverse running. (Brake operation only)

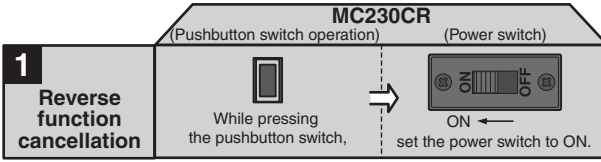

*When desired, you can enable the cancelled reverse function by repeating the operation shown at the left. (The reverse function is switched alternately.)

BRAKE/REVERSE OPERATING INSTRUCTIONS

Operation can be switched to reverse operation by returning the throttle stick from the brake position to the neutral position.



PROTECTION CIRCUIT OPERATION

The following protection circuits are built into the MC230CR. When a protection circuit operates, remove the cause before operating the model again.

Overcurrent protection	When an overcurrent flows due to an output short circuit, etc., the overcurrent protection circuit automatically limits the current to protect the FET. ⇒ Remove the cause of the short circuit, etc. before operating the model again.
Heat protector	When abnormal heating of the FET due to an overload, etc. is detected, the heat protector operates so that the speed is gradually reduced. ⇒ When the FET temperature drops, the heat protector automatically resets. However, remove the cause of the overheating before operating the model again.
Low voltage operation	When the Nicd battery voltage drops, this function limits the motor output current and ensures steering operation. ⇒ After the speed drops, immediately recover the vehicle.

CHECKER LED DISPLAY

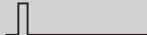
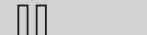
The amp operates linearly in proportion to the amount of forward, reverse, and brake operation. The amp operating state can be checked with the checker LED as shown below.

Operation	Checker LED display
Amp power ON	(Reverse operation set) Single blink (Single confirmation beep)  (Only brake operation set) Double blink (Two confirmation beeps) 
<p>High point</p> <p>Forward</p> <p>Neutral point</p> <p>Reverse /brake</p> <p>Brake MAX point</p>	Off
	On *Becomes brighter nearer the high point.
	Off
	On *Becomes brighter nearer the brake MAX point.
(Amp power left on alarm) When the transmitter power was turned off first.	Blinks. (Confirmation beep also sounds.)  *Not used with PCM receivers. *When the transmitter is OFF, this function is not performed in environments such that the servo operates erroneously. Not sure what this is supposed to mean in yellow.

* Confirmation beep only sounds when the motor was connected.

Reference

Ratings

*Specifications and ratings are subject to change without prior notice.

Transmitter T4GWD

(2 Stick system, 4 channels)

- Transmitting frequencies: 27, 29, 40, 41 or 75MHz band
- Modulation: AM
- Power requirement:
(Dry cell battery)
Penlight x 8 (12V)
(NiCd battery)
NT8F700B NiCd battery (9.6V)
- Current drain: 250mA or less

Receiver R124H

(4 channels, AM receiver)

- Receiving frequencies: 27, 29, 40, 41 or 75MHz band
- Intermediate frequency: 455kHz
- Power requirement:
4.8 or 6.0V (shared with servos)
- Current drain: 5mA (at 4.8V)
- Size: 25.6x37.7x15.3mm
(1.00x1.48x0.60in.)
- Weight: 14.8g (0.52oz.)

Servo S3003

(standard servo)

- Power requirement: 6V
(common with receiver)
- Current drain: 8mA (at 6V / Idle)
- Output torque: 4.1kg-cm (57in.-oz.)
at 6V
- Operating speed: 0.19sec/60 degree
at 6V
- Size: 40.4x19.8x36mm
(1.59x0.78x1.42in.)
- Weight: 37.2g (1.31oz.)

E.S.C. MC230CR

(Electronic speed control)

- Operating system: Forward, reverse, and brake operations are all linear.
- Power requirement: Nicd battery
6-7 cells (7.2 to 8.4V)
- PWM frequency: 1.5kHz (fixed)
- Setting: One-touch input by pushbutton switch. Set data is saved to built-in EEPROM.
- Current capacity (FET rating):
Forward=90A, reverse=45A
- Size: 27.1x33.3x12.8mm
(1.07x1.31x0.50in.)
(excluding protruding parts)
- Silicon cord gauge size:
AWG16 equivalent
- Weight: 44g (1.55oz.)
(including connectors and switches)
- BEC voltage: 6.0V

Optional Parts

The following parts are available as 3GR options. Purchase them to match your application. For other optional parts, refer to our catalog.

Crystal

<Type of Crystal>

There are crystals for FM and AM, depending on the modulation mode, and crystals for single conversion and dual conversion, depending on the receiver circuitry. Use AM crystal sets with R124H.

Warning

 Use only genuine Futaba crystal.

The use of other than Futaba crystal will result in decrease of range as well as loss of control.

Transmitter NiCd Battery

When purchasing a transmitter NiCd battery as a spare, etc., use the following:

Part name: NT8F700B

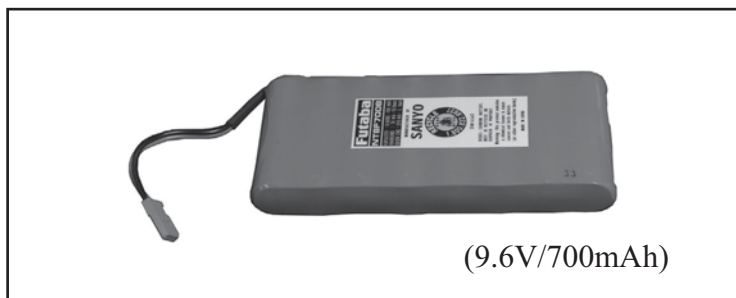

Troubleshooting

If your system fails to operate or you experience a short range problem or erratic control, check the table below for possible causes. If after you have followed the suggestions listed, the problem is not corrected, return the system to our service department for inspection, and repair.

(Item Check)

Transmitter

Battery

Dead battery -> Change the batteries. Charge the NiCd

Batteries inserted incorrectly. -> Reload the batteries in accordance with the polarity markings

Faulty contact -> Check to see if the contacts are bent and not making good contact

Dirty contacts -> Clean the contacts and check for corrosion.

Antenna

Loose -> Be sure the antenna is screwed in tightly

Not fully extended -> Fully extend the antenna

Receiver

Battery

Dead battery -> Replace or recharge

Wrong polarity -> Check connections

Antenna

Near other wiring -> Move away from wiring

Was antenna cut -> Request repair

Is the antenna bundled or coiled -> Keep the antenna straight and as much in the air as possible

Crystal

Loose -> Push in firmly

Wrong brand -> Be sure the frequencies match in transmitter and receiver

Connector connections

Wiring incorrect -> Insert all connectors firmly

Loose connections -> Push the connector in firmly

Linkage

Binding or loose -> Adjust the linkage in model

Is movement stiff -> Adjust linkage in model

Motor (Electric powered)

Noise problems -> Install capacitors on motor

Error Displays

Low Battery Alarm

If the transmitter battery voltage drops to 8.5V or less, an audible alarm will sound and "LOW BT" will be displayed on the LCD screen.

LCD screen:

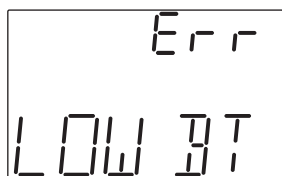

Audible alarm:
Continuous tone.

Warning

 When a low battery alarm is generated, cease operation immediately and retrieve the model.

If the battery goes dead while in operation, you will lose control.

Backup Error

If the data is lost for an unknown reason, an audible alarm will sound and "BCK UP" will be displayed on the LCD screen.

LCD screen:

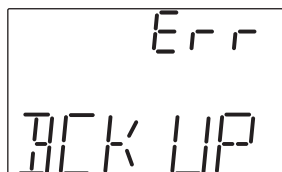

Audible alarm:
Tone will sound (9 times), then repeat.

Warning

 When a backup error is generated, immediately stop using the system and request repair from the Futaba Service Center.

If you continue to use the system, the transmitter may malfunction and cause loss of control.

When requesting repair

Before requesting repair read this instruction again recheck your system. Should the problems continue request as follows.

(Information needed for repair)

Describe the problem in as much detail as possible and send the letter along with the system in question.

- Symptom (Including the conditions and when the problem occurred)
- R/C System (Send transmitter, receiver and servos)
- Model (Type of model, brand name and model number or kit name)
- Detailed packing list (Make a list of all items sent in for repair)
- Your name, address and telephone number.

(Warranty)

Read the Warranty card.

- When requesting warranty service, send the card or some type of dated proof purchase.

Hobby Services (U.S. only)

3002 N. Apollo Drive, Suite 1
Champaign, IL 61822 U.S.A.
Phone: (217) 398-0007
service@futaba-rc.com