

Futaba®

DIGITAL PROPORTIONAL
RADIO CONTROL

FP-7UAPS
PCM 1024 SYSTEM

FP-7UAFS
FM SYSTEM

INSTRUCTION MANUAL

FP-7UAPS, FP-7UAFS

FOR AIRCRAFT
PCM/FM 7 CHANNELS



FUTABA CORPORATION
FUTABA CORPORATION OF AMERICA

*Thank you for purchasing
a Futaba digital proportional radio control set.
Please read this manual
carefully before using your set.
The last page of this manual
is a double foldout showing the name
of each part of the transmitter.
Please open it when reading this manual.*

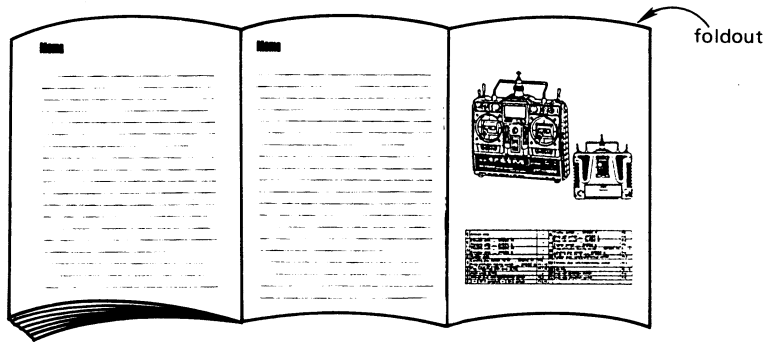

● FEATURES

- High resolution and fast response
- PCM 1024 system (FP-7UAP)
- FM system (FP-7UAF)
- 7 channels system

- Model memory function
(4 model memories)

- Mixing type
"ACRO", "GLID",
"HLI1" & "HLI2"

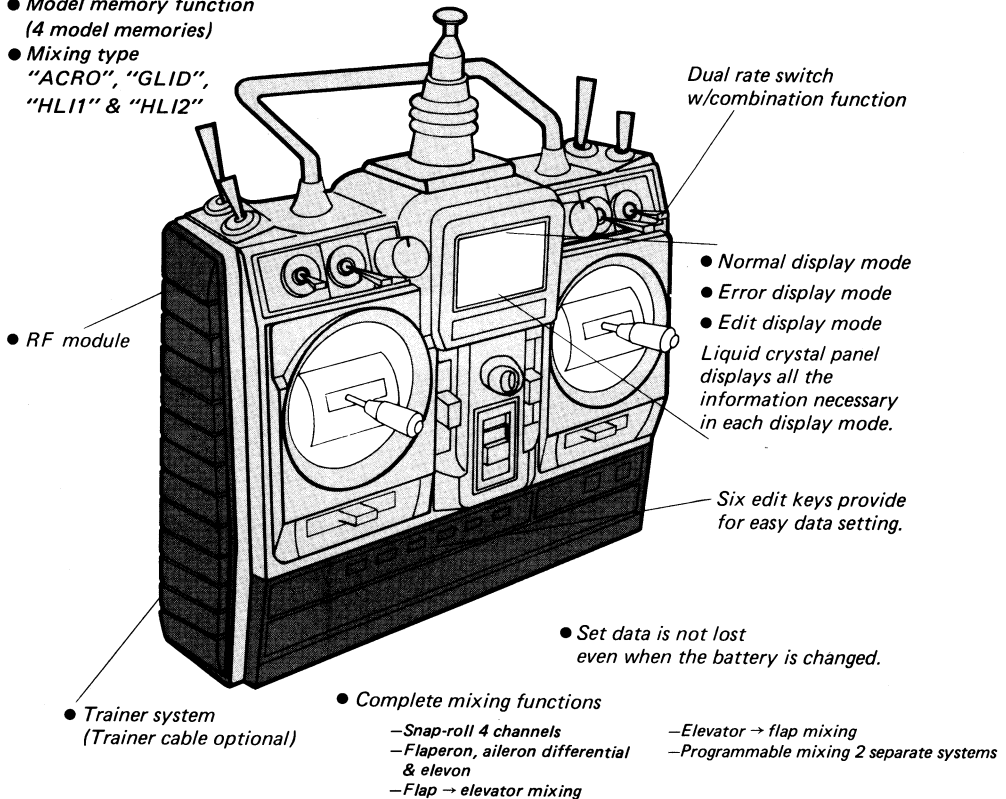

Dual rate switch
w/combination function

- Normal display mode
- Error display mode
- Edit display mode

Liquid crystal panel
displays all the
information necessary
in each display mode.

Six edit keys provide
for easy data setting.

- Set data is not lost
even when the battery is changed.

● RF module

- Trainer system
(Trainer cable optional)

- Complete mixing functions

— Snap-roll 4 channels
— Flaperon, aileron differential
& elevon
— Flap → elevator mixing



— Elevator → flap mixing
— Programmable mixing 2 separate systems

ACRO : Shows a mixing function for the mixing type "ACRO".
HLI1/2 : Shows a mixing function for the mixing type "HLI1" or "HLI2".
GLID : Shows a mixing function for the mixing type "GLID".

SET CONTENTS	2
BEFORE USING	3
DISPLAY FUNCTIONS	6
NORMAL DISPLAY MODE	6
ERROR DISPLAY MODE	7
EDIT DISPLAY MODE	7
FUNCTIONS AND DATA SETTING	
ADJUSTABLE TRAVEL VOLUME	8
DUAL RATE	8
EXPONENTIAL	9
REVERSE	9
FAIL SAFE	10
PROGRAMMABLE MIXING 1 ACRO GLID	11
PROGRAMMABLE MIXING 2 ACRO GLID	12
ELEVATOR → FLAP MIXING ACRO	13
AIR BRAKE MIXING ACRO GLID	14
AILERON → RUDDER MIXING ACRO GLID	15
SNAP-ROLL ACRO	16
AILERON DIFFERENTIAL ACRO GLID	17
FLAPERON ACRO GLID	18
ELEVON ACRO	19
FLAP TRIM ACRO GLID	20
SUB TRIM ACRO GLID	20
PARAMETER	21
DATA RESET	21
ATL TRIM ON/OFF	21
COMBINATION SWITCH	22
PROGRAMMABLE MIXING SWITCH	22
ACRO/GLID/HLI1/HLI2 (MIXING TYPE)	23
MODULATION	23
DATA COPY	24
TRIM MEMORY	24
MODEL SELECT	24
STICK MODE SELECT	25
THROTTLE FUNCTION REVERSE	25
OTHER MIXING FUNCTIONS HLI1/2 GLID	26
OTHER FUNCTIONS	38
USING THE ACCESSORIES	39
SUMMARY OF PROGRAMMES ("ACRO", "HLI1/2", "GLID")	41
DATA SHEET ("ACRO", "HLI1/2", "GLID")	44
NOMENCLATURE (DOUBLE FOLDOUT)	50
SERVO EXPLODED VIEW	51

● SET CONTENTS

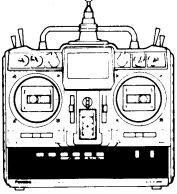
*Specifications are subject to change without prior notice.

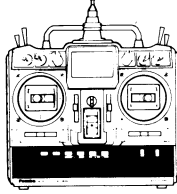
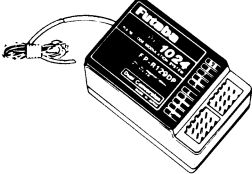
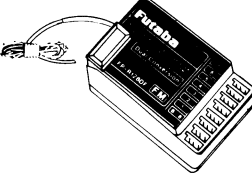
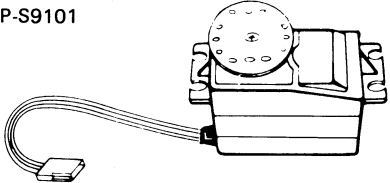
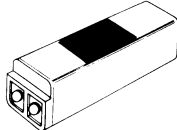
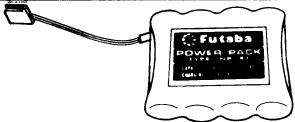
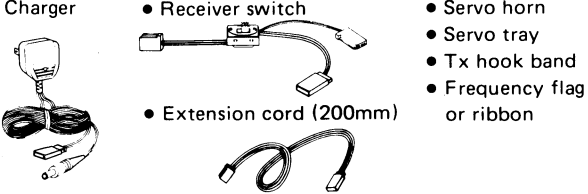
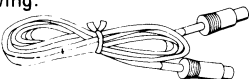
	FP-7UAPS	FP-7UAFS	Rating			
Transmitter and RF module	<ul style="list-style-type: none"> ● FP-T7UAS (X1) 	<ul style="list-style-type: none"> ● FP-TP-FM (X1) 	<ul style="list-style-type: none"> ● FP-T7UAFS (X1) 	2 sticks, 7 channels, PCM or FM transmitter Transmitting frequency: 72MHz, 50MHz, 35/36MHz, 40/41MHz or 29MHz band Modulation: FM-PCM/PPM Selectable Power requirement: 9.6V Nicd battery pack Current drain: 200mA		
Receiver	<ul style="list-style-type: none"> ● FP-R129DP (X1) (Dual Conversion Type) or FP-R137GP (X1) 	<ul style="list-style-type: none"> ● FP-R128DF (X1) (Dual Conversion Type) 	Receiving frequency: 72MHz, 50MHz, 35/36MHz, 40/41MHz or 29MHz band Intermediate frequency: 1st IF 10.7MHz, 2nd IF 455kHz (R129DP, R128DF), 455kHz (R137GP) Power requirement: 4.8V Nicd battery pack (shared with servo) Current drain: 35mA (R129DP), 26mA (R128DF), 25mA (R137GP) Dimensions: 63.0x37.8x24.1mm (R129DP), 63.8x35.4x20.3mm (R128DF) (excluding protruding parts), 57x42x24mm (R137GP) Weight: 45g (R129DP), 40g (R128DF), 45g (R137GP) Receiving range: 500m on the ground, 1000m in the air (range differs with the surroundings)			
Servo	<ul style="list-style-type: none"> ● FP-S148 FP-S3001 or FP-S9101 		Control system: + pulse width control Operating angle: Rotary system, one side 45° or greater (including trim) Power requirement: 4.8V or 6.0V (S148, S3001) 4.8V (S9101) Current drain: 8mA (at idle) Output torque: 3kg·cm (S148, S3001), 3.1kg·cm (S9101) Operating speed: 0.22 sec/60° (S148, S3001), 0.16 sec/60° (S9101) Dimensions: 40.4x19.8x36mm (S148, S3001), 38.5x19.5x34.5mm (S9101) Weight: 44.4g/1.56oz. (S148) 45.1g/1.59oz. (S3001), 45g/1.59oz. (S9101)			
Transmitter battery	<ul style="list-style-type: none"> ● NT-8LP (X1) 		Voltage: 9.6V Capacity: 500mAh			
Receiver battery	<ul style="list-style-type: none"> ● NR-4J (X1) 		Voltage: 4.8V Capacity: 500mAh Dimensions: 51x58x15mm Weight: 95g, 3.35 oz.			
Accessories	<ul style="list-style-type: none"> ● Charger ● Receiver switch ● Servo horn ● Servo tray ● Tx hook band ● Frequency flag or ribbon ● Extension cord (200mm) 					
Crystal	<ul style="list-style-type: none"> ● FM crystal set (Transmitter and Receiver) However use the following crystal types for dual conversion receiver (R129DP, R128DF).					
		72MHz band	50MHz band	40MHz band	35MHz band	Remarks
	Receiver crystal type	TYPE 72-10	TYPE 50-10	TYPE 40-10	TYPE 35-10	Dual conversion
Options	The set does not include the following: <ul style="list-style-type: none"> ● Trainer cable (6-conductor) 					

■ Charging the transmitter and receiver Nicd battery

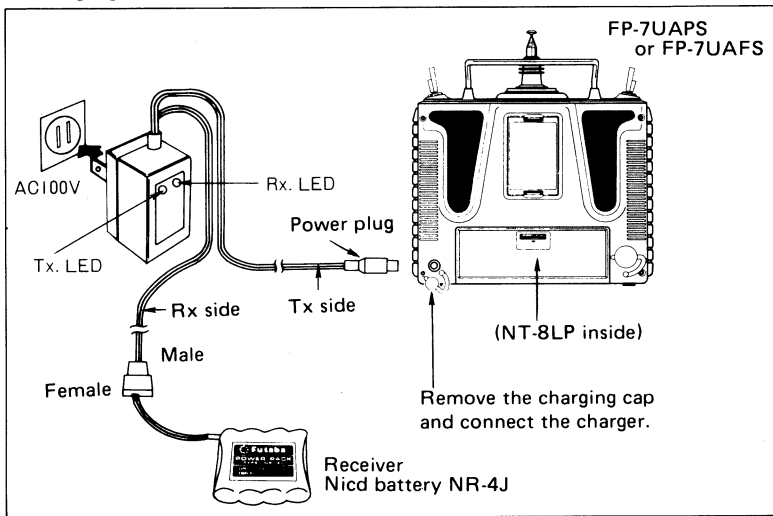

- * Use the special Futaba charger.
- The charging time is 15 hours.

[However when the battery was not used for some time, charge and discharge it 2 – 3 times. Otherwise, the battery will not be charged even after the specified charging time.]

A fully-charged transmitter battery can be used for about 10 flights of 10 minutes each. The airborne NR-4J Nicd battery pack can be used for about 6 flights when 6 servos are used.

Notes: (FBC-8B)

- 1) First, connect to TX Nicad and red lamp goes on.
- 2) Then, connect to RX Nicad after connecting, L, E, D, changes color from red to greenish red (orange) which indicates that both TX and RX Nicads are being charged.
- 3) In case of separate charging, L, E, D, color will be:
RX Nicad – Green
TX Nicad – Red

■ Factory setting of transmitter modulation system

The transmitter modulation system (PCM/PPM mode) is switched by data setting. (For the setting method, see P23.). However, it is set as follows at the factory:

FP-T7UAPS PCM mode FP-T7UAFS PPM mode

Refer to only the necessary items of the items enclosed in .

■ Changing the transmitter Nicd battery pack

1 Remove the battery cover.

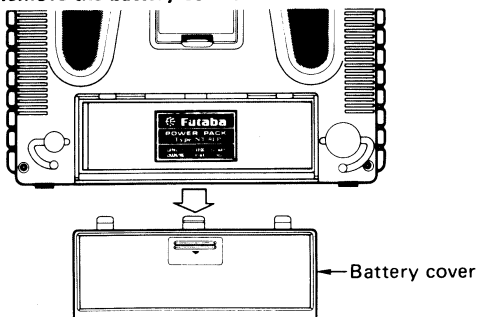

2 Change the Nicd battery.

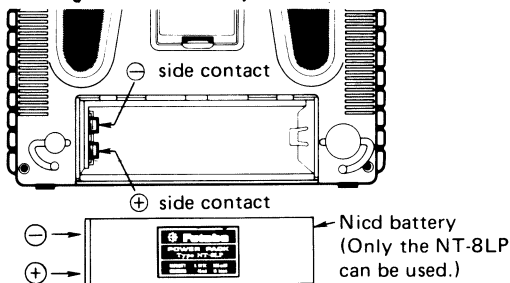

* Load the battery while paying careful attention to the direction of the contacts.

■ Changing the RF module to change the frequency band

1 Remove the RF module.

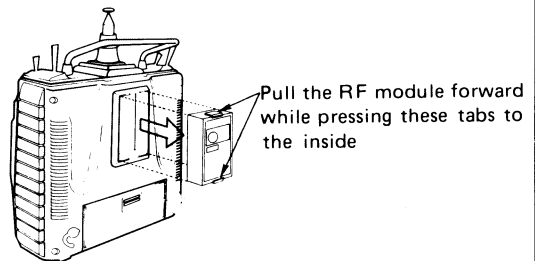

2 Change the RF module.

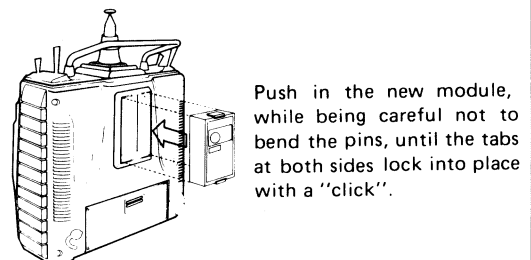

* Use the special FP-TP-FM RF module for the FP-7UAPS and 7UAFS. Other RF modules cannot be used.

- When the transmitter frequency band is changed, the receiver frequency band must be changed also.

● BEFORE USING

■ RECEIVER AND SERVO CONNECTIONS

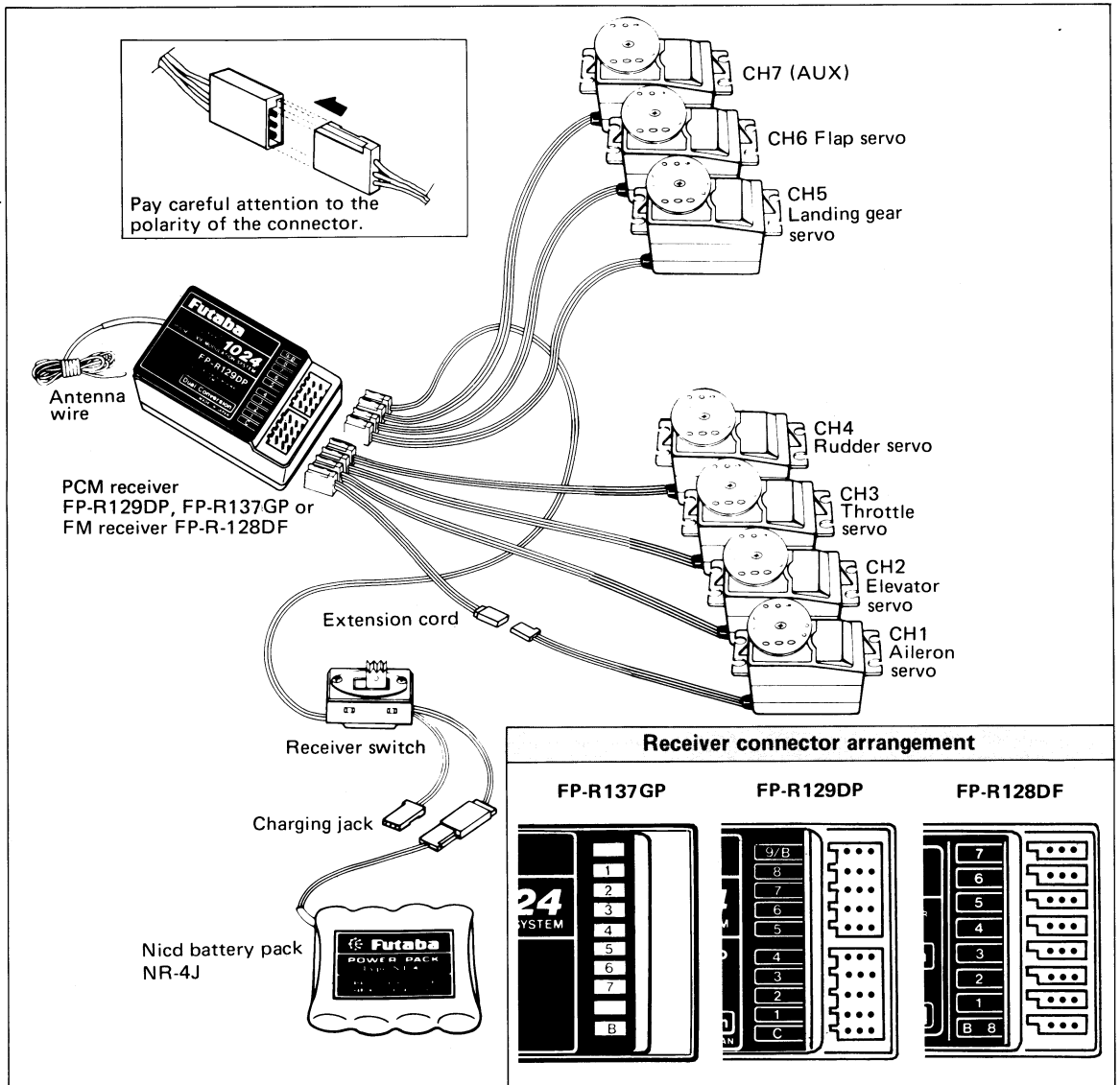

PRECAUTIONS

- Connect the receiver, servos, switches, and battery as shown in the figure. Extend the transmitter and receiver antennas to their full length.
- Turn on the transmitter power switch, then turn on the receiver power switch. The servos will go to their neutral position. Move the transmitter sticks one at a time to check that each servo follows its control stick movement.
- Connect the pushrods to the servos and check that the direction of travel of each servo matches the direction of movement of its control stick. If a servo does not move in the proper direction, switch its direction with the servo reversing function.
- Operate each servo horn over its full stroke and check that the pushrod does not bind or is not too loose. Unreasonable force applied to the servo horn will adversely affect the servo and

drain the battery pack very quickly. Make the travel of each control mechanism somewhat larger than the full stroke (including trim) of the servo horn. Adjust the servo horns so that they move smoothly even when the trim lever and stick are operated simultaneously in the same direction.

- Be alert for noise.
This set is noise-resistant, but not completely immune to noise. The use of noiseless parts is recommended.
- When installing the switch harness, cut a rectangular hole slightly larger than the full stroke of the switch and install the switch so that it moves smoothly from ON to OFF. Also do this when the switch is installed inside the fuselage and is turned on and off from the outside with a piece of wire. Install the switch where it will not be exposed to engine oil or dust and dirt.
- Although the antenna appears to be too long, do not cut it or fold it back.
- Install the servos securely. Tighten the mounting screws until the rubber damper is crushed slightly. If the screws are too tight, the cushioning effect will be adversely effected.

- The crystal can be changed from the outside of the receiver case. Always use the Futaba transmitter/receiver matched crystal set to change the band.
 - The receiver that is used with the 7UAPS and 7UAFS is a dual conversion receiver. This receiver requires a special crystal so please order the correct crystal set.
 - Spare servo horns are supplied. Use them as needed.
 - Use extension cords matched to the model.
 - Wrap the receiver in sponge rubber. Place it inside a waterproof plastic bag and secure the end of the bag with a rubber band. Do the same with the airborne battery pack.
 - Use the rubber bands wrapped around the receiver to hold the servo and switch leads.
 - After installation and checking are complete, perform a range check by collapsing the transmitter antenna and extending the receiver antenna to its full length and operating the transmitter from a distance of 20 to 30 meters from the receiver. The servos should operate normally at this distance.
- * Differs with the weather and surroundings.

■ SERVO HORN MOUNTING SCREW PRECAUTIONS

Servo horn screws				
Horn mounting screw		Applicable servo	Type	Dimensions (mm)
Size	Type			
2.6x6	tapping	S133, S143 series	B	5.7
2.6x8	tapping	S129 series	A	7.9
		S130 series, S9101, S5101		
		S128 series	B	11.9
		S132 series	B	7.3
		S135 series, S9601	B	8.7
2.6x10	tapping	S138 series	B	9.9
		S148 series	B	10.5
2.6x12	tapping	S131S series, S136G, S9201, S9301, S9401	A	9.0
2.6x12	tapping	S134 series, S3301	A	11.3
2.6x5		S3002	B	10.0
		S3302	A	5.0
		S5102	A	5.5
		S9302	A	9.0

Waterproof type A

Non-waterproof type B

Note:

- If screws longer than necessary are used, the final gear may be broken or the potentiometer may be damaged or may fall out.

● DISPLAY FUNCTION

Liquid crystal panel

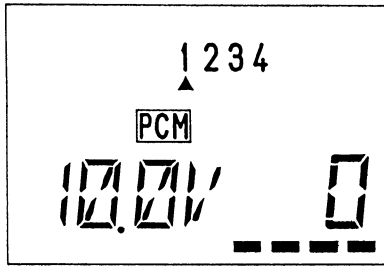

● Operated in three display modes

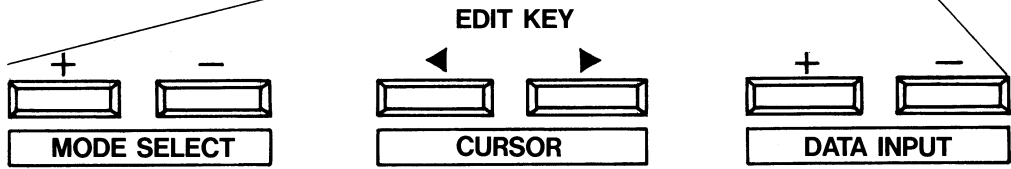
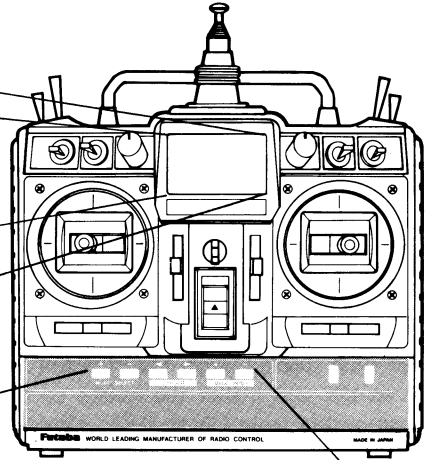

- Used in display mode switching.
- Used in setting function selection.

● Used at data setting.

Normal display mode

Display mode at normal use (Mode which is displayed when the power switch is turned on.)

(Display)

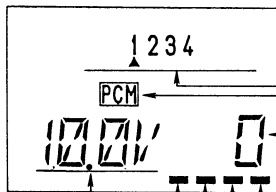

Battery voltage display

- Model memory No. (No. 1 - 4)
- PCM/PPM mode display (PCM: PCM mode, PPM: PPM mode)
- Integrated time display (0 - 199 minutes) (Displays the integrated time after reset.)

Clock reset



Reset by pressing the [DATA INPUT] keys simultaneously.

- Flashes at a 1 second period
- F/S data transfer display (FP-7UAP only) (Lights momentarily each minute)
- RF indicator (Lights when radiowaves are transmitted.)
- Mixing indicator (Flashes when snap roll mixing, 6 → 2 mixing, idle-up, throttle hold, inverted flight or rudder offset is ON.)
- Mixing alarm (buzzer sounds) (Sounds when air brake mixing, throttle hold or idle-up is ON when the power switch is turned on.)

Displa



Erro

Edit display mode

Function data setting display mode

(Display)

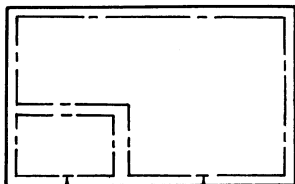

Function name

Function setting parameters
(See the individual function setting items.)

(Set function recall)

- The function is selected by **MODE SELECT** key.

(However, **CURSOR** key for "PARA" functions.)

mode switching

The display mode is switched by pressing the **MODE SELECT** keys simultaneously.

Common function

Special mixing

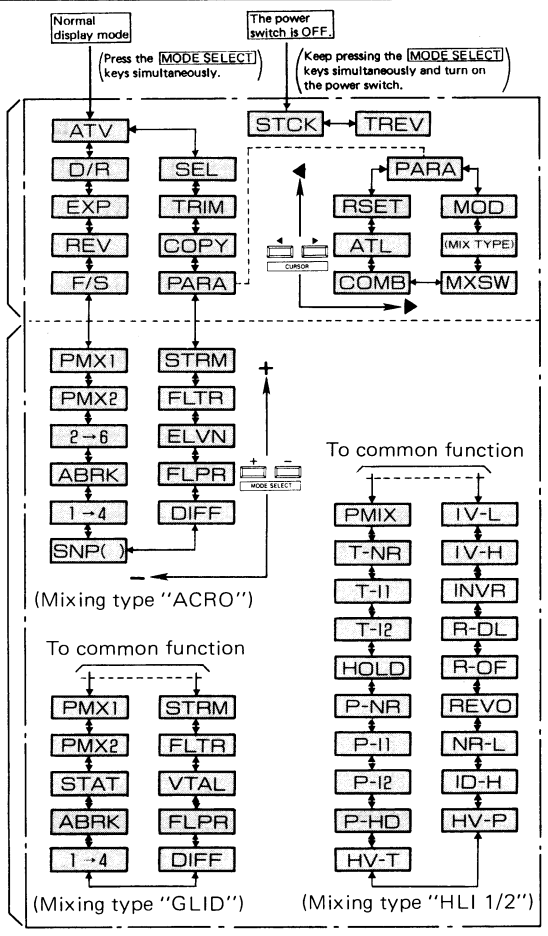

Error generation

Error display mode

Display mode at error generation (Switched automatically from other modes)

(LOW BATTERY error display)

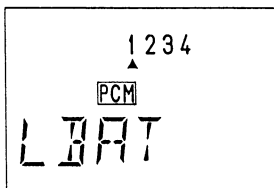

(BACK-UP error display)

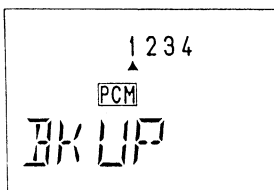

- The characters flash and a buzzer sounds.

Charge, or change, the battery.

Charging method P3

- Characters flash and a buzzer sounds.

Turn off the power switch and then turn on.

generation

● FUNCTION AND DATA SETTING

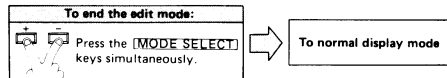

Function	Display	Data setting
<p>ATV ADJUSTABLE TRAVEL VOLUME</p> <p>This function adjusts the servo left and right throws and is used in linkage correction.</p> <ul style="list-style-type: none"> • The rate can be set for each channel. • The left and right (up, down) rate can be set. • The rate setting range is 30% to 120%. 	<p>(R/U: Right or up L/D: Left or down)</p>	<p>1 CH selection</p> <p>Select the CH to which ATV is to be applied with the [CURSOR] keys.</p> <hr/> <p>2 Direction selection</p> <p>Select the Direction with the [STICK], [VR], or [SWITCH]. The rate described below is set.</p> <hr/> <p>3 Rate setting</p> <p>Set the rate with the [DATA INPUT] keys. (When the + and - keys are pressed simultaneously, 100% is set.)</p> <p>Set for a different CH and direction by repeating steps 1 to 3.</p>

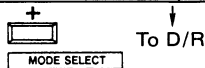

Function	Display	Data setting
<p>D/R DUAL RATE</p> <p>The rate can be switched with the [D/R SWITCH].</p> <ul style="list-style-type: none"> • D/R can be set for CH1 (aileron), CH2 (elevator), and CH4 (rudder). • D/R can be set for each direction of the [D/R SWITCH]. With this feature you can select which switch position you want for high rate and low rate. • The rate setting range is 30% to 120%. <p>*Related function COMBINATION SWITCH. </p> <p>[D/R SWITCH]</p>	 	<p>1 CH selection</p> <p>Select the CH for which D/R is to be set with the [CURSOR] keys.</p> <hr/> <p>2 D/R switch direction selection</p> <p>Switch to the direction for which the [D/R SWITCH] is to be set.</p> <hr/> <p>3 Rate setting</p> <p>Set the rate with the [DATA INPUT] keys. (When the + and - keys are pressed simultaneously, 100% is set.)</p> <p>Set for a different CH and [D/R SWITCH] direction by repeating steps 1 to 3.</p>

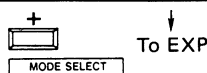

● FUNCTION AND DATA SETTING

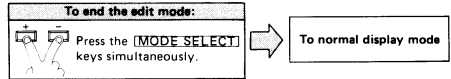

Function	Display	Data setting
<p>EXP EXPONENTIAL</p> <p>This function modifies the operating curve so that operation is easy when the movement of the servos becomes sluggish or sensitive near the neutral position. (However, near the slow position for throttle.)</p> <ul style="list-style-type: none"> EXP can be set for CH1 (aileron), CH2 (elevator), CH3 (throttle), and CH4 (rudder). However, except CH3 when the mixing type is "HLI1" or "HLI2". The rate can be set for each direction of the [D/R SWITCH]. (However, there is no [D/R SWITCH] for the throttle.) The rate setting range is -100% (slow side) to +100% (quick side) in 4% steps. <p>EXP SWITCH</p>		<p>1 CH selection</p> <p>Select the CH to which EXP is to be applied with the [CURSOR] keys.</p> <hr/> <p>2 D/R switch direction selection</p> <p>Switch to the direction to which the [D/R SWITCH] is to be set.</p> <hr/> <p>3 Rate setting</p> <p>Set the rate with the [DATA INPUT] keys. (When the + and - keys are pressed simultaneously, 0% is set.)</p> <hr/> <p>Set for a different CH and [EXP SWITCH] direction by repeating steps 1 to 3.</p> <p>(Note) At initial flight, test at EXP 0%. Adjustment as desired in accordance with flight is recommended.</p>

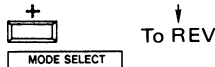

Function	Display	Data setting
<p>REV REVERSE</p> <p>Used when modifying servo direction of operation.</p> <ul style="list-style-type: none"> Can be set for each channel. 		<p>1 CH selection</p> <p>Select the CH for which REV is to be set with the [CURSOR] keys. (CH NO. flashes)</p> <hr/> <p>2 Direction of operation setting</p> <p>Set the direction with the [DATA INPUT] keys. (+ : Normal) (- : Reverse)</p> <hr/> <p>Set for another channel by repeating steps 1 and 2.</p> <p>(Note) Be especially careful in the aileron direction.</p>

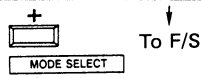

● FUNCTION AND DATA SETTING

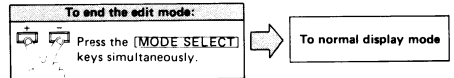

Function	Display	Data setting
<p>F/S FAIL SAFE</p> <p>F/S and HOLD functions</p> <ul style="list-style-type: none"> ● F/S and HOLD can be set for all channels. ● The F/S and HOLD functions can be selected for each channel. <p>(HOLD function setting) When interference makes reception impossible, the servos are stopped in position just before erroneous operation is performed. When the interference ceases, the HOLD mode is released.</p> <p>(F/S function setting) When interference makes reception impossible, the servos move to the position set at the transmitter. When the interference ceases, the F/S function is reset.</p> <p>*The F/S set data is automatically sent every minute.</p> <p>*The PPM mode does not have an F/S function. (FP-7UAFS)</p> <p>*When using the B.F/S function, set the throttle channel F/S function.</p>	<p>(HLD: HOLD function) (F/S: F/S function)</p>	<p>1 CH selection</p> <p>Select the CH which is to be set to F/S or HOLD with the [CURSOR] keys. (CH NO. flashes)</p> <hr/> <p>2 Function selection</p> <p>Select the function with the [DATA INPUT] keys. (+: HOLD function) (-: F/S function)</p> <p>Select the function for another channel by repeating steps 1 and 2.</p> <hr/> <p>3 F/S function selected CH servo operating position setting</p> <p>1</p> <p>Set the flashing display to "SET" with the [CURSOR] keys.</p> <p>2</p> <p>The channel [STICK], [VR], or [SWITCH] for which the F/S function was selected is held in the desired position.</p> <p>Press the [DATA INPUT] keys simultaneously. (The servo operating position is set. At the same time, data is automatically sent to the receiver.)</p> <p>To PMX1</p>

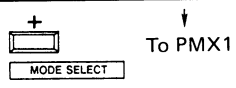

● FUNCTION AND DATA SETTING

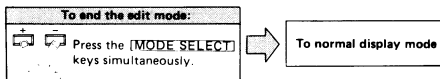



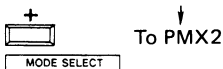

Function	Display	Data setting
<p>PMX 1 ACRO GLID PROGRAMMABLE MIXING 1</p> <p>This mixing is useful in correcting bad tendencies of the aircraft and in making operation more pleasant.</p> <ul style="list-style-type: none"> • Mixing of any two channels is possible. • The left and right (up and down) mixing rate can be set independently. • Setting range: 0 – 100% (mixing maximum) 	<p>(INH: Inhibit state)</p> <p>(Activate state ON: [P.MIX switch] ON OFF: [P.MIX switch] OFF)</p> <p>(R/U: Right or up L/D: Left or down)</p>	<p>1 Mixing activate/inhibit mode setting</p> <p>Set the mode with the [DATA INPUT] keys. (+ : Activate) (- : Inhibit)</p> <p>2 Master channel selection</p> <p>① Set the flashing display to the "▼" mark with the [CURSOR] keys.</p> <p>② Select the channel to be set with the [DATA INPUT] keys.</p> <p>3 Slave channel selection</p> <p>① Set the flashing display to the "▲" mark with the [CURSOR] keys.</p> <p>② Select the channel to be set with the [DATA INPUT] keys.</p> <p>4 Mixing servo direction of operation setting</p> <p>① Set the flashing display to "+" (or "-") with the [CURSOR] keys.</p> <p>② Hold as long as the master channel stick (VR or switch) is in the R/U or L/D direction.</p> <p>③ Set the direction of operation with the [DATA INPUT] keys. (+ : Normal direction) (- : Reverse direction)</p> <p>④ Set another direction by repeating steps ① and ②.</p> <p>5 Mixing rate setting</p> <p>① Set the flashing display to "%" with [CURSOR] keys.</p> <p>② Set the same as ④ - ②</p> <p>③ Set the mixing rate with the [DATA INPUT] keys. (When the + and - keys are pressed simultaneously, 50% is set.)</p> <p>④ Set the same as ④ - ④</p>

[ON/OFF switch]

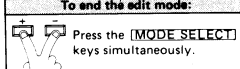

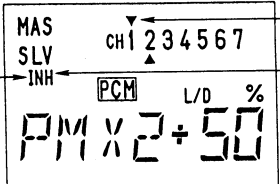
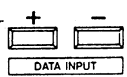
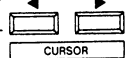
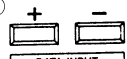
● FUNCTION AND DATA SETTING

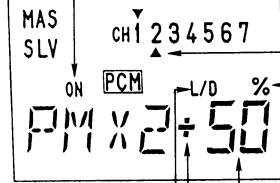
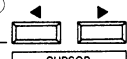
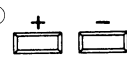
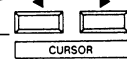
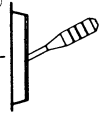
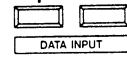
To end the edit mode:
 Press the [MODE SELECT] keys simultaneously. → To normal display mode

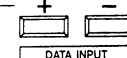
Function	Display	Data setting
PMX2 [ACRO] [GLID] PROGRAMMABLE MIXING 2		1 Mixing activate/inhibit mode setting Set the mode with the [DATA INPUT] keys.  (+ : Activate) (- : Inhibit)
This mixing is useful in correcting bad tendencies of the aircraft and in making operation more pleasant. <ul style="list-style-type: none"> Mixing of any two channels is possible. The left and right (up and down) mixing rate can be set independently. Setting range: 0 – 100% (mixing maximum) 	(INH: Inhibit state) (Activate state ON: [P.MIX switch] ON OFF: [P.MIX switch] OFF)	2 Master channel selection ①  Set the flashing display to the "▼" mark with the [CURSOR] keys. ②  Select the channel to be set with the [DATA INPUT] keys.
[ON/OFF switch] (OFF)  P. MIX (ON)		3 Slave channel selection ①  Set the flashing display to the "▲" mark with the [CURSOR] keys. ②  Select the channel to be set with the [DATA INPUT] keys.
	(R/U: Right or up) (L/D: Left or down)	4 Mixing servo direction of operation setting ①  Set the flashing display to "+" (or "-") with the [CURSOR] keys. ②  Hold as long as the master channel stick (VR or switch) is in the R/U or L/D direction. ③  Set the direction of operation with the [DATA INPUT] keys. (+ : Normal direction) (- : Reverse direction) ④ Set another direction by repeating steps ① and ③.
		5 Mixing rate setting ①  Set the flashing display to "%" with [CURSOR] keys. ② Set the same as 4 - ② ③  Set the mixing rate with the [DATA INPUT] keys. (When the + and - keys are pressed simultaneously, 50% is set.) ④ Set the same as 4 - ④

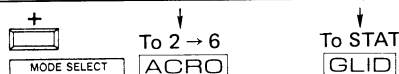

● FUNCTION AND DATA SETTING

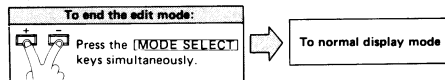

Function	Display	Data setting
<p>2→6 ACRO ELEVATOR → FLAP MIXING</p> <p>This is used to apply mixing from elevator to flap. Mixing is usually used so that the flaps are lowered when the elevator is raised. It makes circular maneuvers with stunt aircraft smoother.</p> <p>• The elevator up side and down side mixing rate can be set independently.</p> <p>ON/OFF SWITCH</p>	<p>MAS SLV CH 1 2 3 4 5 6 7</p> <p>INH PCM L/D %</p> <p>2--16+50</p> <p>(INH: Inhibit state)</p> <p>(Activate state OFF: MIX SWITCH OFF ON: MIX SWITCH ON)</p> <p>MAS SLV CH 1 2 3 4 5 6 7</p> <p>ON PCM L/D SET %</p> <p>2--16+50</p> <p>(R/U: Right or up L/D: Left or down)</p>	<p>1 Mixing activate/inhibit mode setting</p> <p>Set the mode with the [DATA INPUT] keys. (+: Activate) (-: Inhibit)</p> <p>2 Mixing servo direction of operation setting</p> <p>① Set the flashing display to “+” (or “-”) with the [DATA INPUT] keys.</p> <p>② Hold as long as the elevator [STICK] is in the R/U or L/D direction.</p> <p>③ Set the direction of operation with the [DATA INPUT] keys. (+: Normal direction) (-: Reverse direction)</p> <p>④ Set for another direction of the elevator [STICK] by repeating steps ② and ③.</p> <p>3 Mixing rate setting</p> <p>① Set the flashing display to “%” with the [CURSOR] keys.</p> <p>② Hold as long as the elevator [STICK] is in the R/U or L/D direction.</p> <p>③ Set the mixing rate with the [DATA INPUT] keys. (When the + and - keys are pressed simultaneously, 50% is set.)</p> <p>④ Set a different elevator [STICK] direction by repeating steps ② and ③.</p>

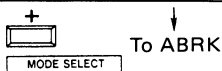

● FUNCTION AND DATA SETTING

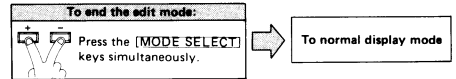

Function	Display	Data setting
<p>ABRK ACRO GLID</p> <p>AIR BRAKE MIXING</p> <p>Use this mixing when an air brake is necessary when landing or diving, etc. during flight. The operating mode can be selected.</p> <p>● The operating position of the elevator, flap and aileron servos can be set.</p> <p>[ON/OFF SWITCH]</p> <p>(Operating mode)</p> <p>1. Linear mixing The mixing rate varies in proportion to the throttle operation. The mixing rate is maximum at low side. The cut off point of the mixing can be set.</p> <p>2. Offset mixing When turning on the ON/OFF switch, the servos move to the preset position.</p>	<p>(INH: Inhibit state)</p> <p>(Activate state OFF: [MIX SWITCH] OFF ON: [MIX SWITCH] ON)</p>	<p>1 Activate/inhibit mode setting</p> <p>+ - Set the mode with the [DATA INPUT] keys. [DATA INPUT] (+: Activate) (-: Inhibit)</p> <hr/> <p>2 Elevator, flap and aileron servo throw setting</p> <p>① ◀ ▶ Set the flashing display to any channel "▲" with the [CURSOR] keys. [CURSOR]</p> <p>② + - Set the rate with the [DATA INPUT] keys. [DATA INPUT] (When the + and - keys are pressed simultaneously, 0% is set.)</p> <p>*When not using the 2nd aileron, the operating position of the aileron can not be set.</p> <hr/> <p>3 Operating mode setting</p> <p>① ◀ ▶ Set the flashing display to channel 3 "▲" with the [CURSOR] keys. [CURSOR]</p> <p>② + - Set the mode with the [DATA INPUT] keys. [DATA INPUT] (+: "On" Linear mixing) (-: "OF" Offset mixing)</p> <hr/> <p>4 Cut off point setting</p> <p>① ◀ ▶ Set the flashing display to "SET" with the [CURSOR] keys. [CURSOR]</p> <p>② Hold the throttle at the cut off point.</p> <p>③ + - Press the [DATA INPUT] keys simultaneously. [DATA INPUT]</p>



● FUNCTION AND DATA SETTING

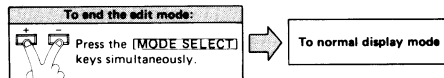

1-4 ACRO GLID AILERON → RUDDER MIXING

This is used to make an aircraft turn properly.
The operating mode can be selected.

- The aileron left side and right side mixing rate can be set independently.

(Operating mode)

1. Always ON.
2. ON/OFF with the rudder D/R switch.

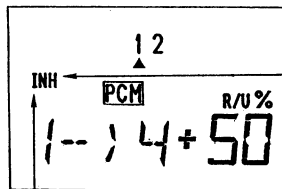

(INH: Inhibit state)

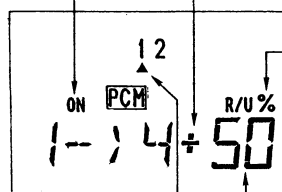

(ON: Activate state)

1 Activate/inhibit mode setting

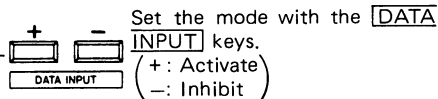

2 Mixing servo direction of operation setting

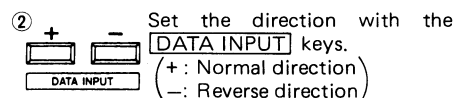
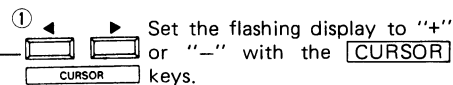

*Set each direction of the aileron [STICK].

3 Mixing rate setting

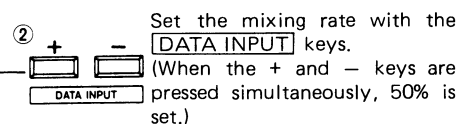
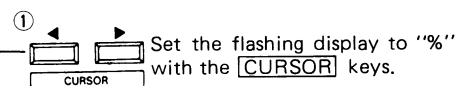

*Set each direction of the aileron [STICK].

4 Operating mode setting

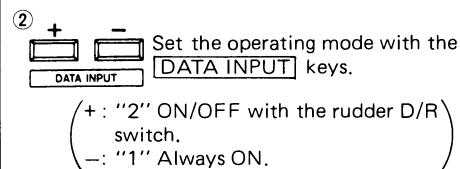
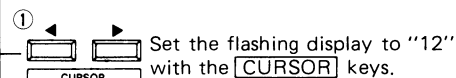

● FUNCTION AND DATA SETTING

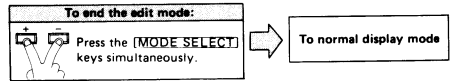

Function	Display	Data setting
SNP ACRO SNAP-ROLL Avalanche and other snap rolls can be performed by switch. • Four snap roll directions can be set. (R/U: Right up snap R/D: Right down snap L/U: Left up snap L/D: Left down snap) • The throw of the channel 1 (aileron), channel 2 (elevator), and channel 4 (rudder) servos can be set. • The SAFETY mode can be set. (Mode in which operation is not performed when the landing gear is down even if the switch is turned on by mistake.)	<p>(INH: Inhibit state)</p> <p>(Activate state OFF: [ON/OFF SWITCH] OFF ON: [ON/OFF SWITCH] ON)</p> <p>(“1” to “4” is displayed according to the [DIRECTION SWITCH] position. 1: R/U 2: R/D 3: L/U 4: L/D)</p>	1 Activate/inhibit mode setting Set the mode with the [DATA INPUT] keys. (+: Activate) (–: Inhibit) 2 Select the direction Switch the [DIRECTION SWITCH] to the combination of directions to be set. 3 Aileron servo throw setting ① Set the flashing display to CH1 with the [DATA INPUT] keys. ② Set the rate with the [DATA INPUT] keys. (When the + and – keys are pressed simultaneously, 100% is set.) 4 Elevator servo throw setting Set the same as ③. 5 Rudder servo throw setting Set the same as ③. Set for each direction of the [DIRECTION SWITCH] by repeating steps ② to ⑤. 6 SAFETY mode setting ① Set the “▲” to CH5 with the [CURSOR] keys. ② GEAR CH5 Set the [CH5 SWITCH] to the direction for which snap roll is to be turned off (direction in which landing gear is down). ③ Press the – side of the [DATA INPUT] keys. 7 SAFETY mode release ① Set the “▲” to CH5 with the [CURSOR] keys. ② Press the + side of the [DATA INPUT] keys.

[ON/OFF SWITCH]



[DIRECTION SWITCH]

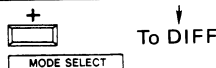
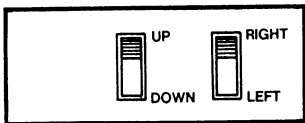

● FUNCTION AND DATA SETTING

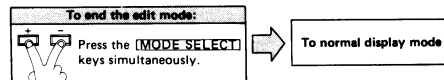

Function	Display	Data setting
<p>DIFF [ACRO] [GLID] AILERON DIFFERENTIAL</p> <p>A left and right differential can be applied to the ailerons. This is effective in roll axis correction. (Left and right aileron servos are necessary.)</p> <p>The left and right mixing rate of each servo can be set independently.</p> <ul style="list-style-type: none"> The operating channels are CH1 and CH7. <p>*AIL DIFF AND FLAPERON cannot be on simultaneously. The function turned on last has priority.</p>	<p>(INH: Inhibit state)</p> <p>(ON: Activate state)</p>	<p>1 Activate/inhibit mode setting</p> <p>Set the mode with the [DATA INPUT] keys. (+: Activate) (-: Inhibit)</p> <p>2 Set the CH1 servo direction of operation.</p> <p>① Set the flashing display to "+" or "-" with the [CURSOR] keys. (Slave CH: CH1)</p> <p>② Set the direction of operation with the [DATA INPUT] keys. (+: Normal direction) (-: Reverse direction)</p> <p>3 CH1 servo throw setting</p> <p>① Set the flashing display to "%" with the [CURSOR] keys. (Slave CH: CH1)</p> <p>② Hold as long as the aileron [STICK] is at the right. (R/U)</p> <p>③ Set the rate with the [DATA INPUT] keys. (When the + and - keys are pressed simultaneously, 100% is set.)</p> <p>*Set each direction of the aileron [STICK].</p> <p>4 CH7 servo direction of operation setting</p> <p>① Set the flashing display to "+" or "-" with the [CURSOR] keys. (Slave CH: CH7)</p> <p>② Set the direction of operation with the [DATA INPUT] keys. (+: Normal direction) (-: Reverse direction)</p> <p>5 CH7 servo throw setting</p> <p>① Set the flashing display to "%" with the [CURSOR] keys. (Slave CH: CH7)</p> <p>② Hold as long as the aileron [STICK] is at the right. (R/U)</p> <p>③ Set the rate with the [DATA INPUT] keys. (When the + and - keys are pressed simultaneously, 100% is set.)</p> <p>*Set each direction of the aileron [STICK].</p>

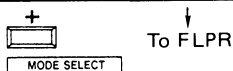

● FUNCTION AND DATA SETTING

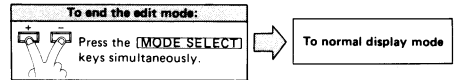

Function	Display	Data setting
<p>FLPR ACRO GLID</p> <p>FLAPERON</p> <p>This is a mixing function which gives the ailerons a flap function. The ailerons can be raised and lowered simultaneously. Aileron operation is also performed.</p> <p>The mixing rate of each servo can be set independently.</p> <ul style="list-style-type: none"> The operating channels are CH1 and CH6. <p>[FLAP TRIM VOLUME]</p> <p>Ailerons can be raised and lowered simultaneously.</p> <p>*AIL DIFF and FLAPERON cannot be on simultaneously. The function set last has priority.</p>	<p>(INH: Inhibit state)</p> <p>(ON: Activate state)</p>	<p>1 Activate/inhibit mode setting</p> <p>Set the mode with the [DATA INPUT] keys. (+: Activate) (-: Inhibit)</p> <p>2 Set the CH1 servo direction of operation</p> <p>① Set the flashing display to "+" or "-" with the [CURSOR] keys. (Slave CH: CH1)</p> <p>② Set the direction of operation with the [DATA INPUT] keys. (+: Normal direction) (-: Reverse direction)</p> <p>3 CH1 servo throw setting</p> <p>① Set the flashing display to "%" with the [CURSOR] keys. (Slave CH: CH1)</p> <p>② Hold as long as the aileron [STICK] is at the right. (R/U)</p> <p>③ Set the rate with the [DATA INPUT] keys. (When the + and - keys are pressed simultaneously, 100% is set.)</p> <p>*Set each direction of the aileron [STICK].</p> <p>4 CH6 servo direction of operation setting</p> <p>① Set the flashing display to "+" or "-" with the [CURSOR] keys. (Slave CH: CH6)</p> <p>② Set the direction of operation with the [DATA INPUT] keys. (+: Normal direction) (-: Reverse direction)</p> <p>5 CH6 servo throw setting</p> <p>① Set the flashing display to "%" with the [CURSOR] keys. (Slave CH: CH6)</p> <p>② Hold as long as the aileron [STICK] is at the right. (R/U)</p> <p>③ Set the rate with the [DATA INPUT] keys. (When the + and - keys are pressed simultaneously, 100% is set.)</p> <p>*Set each direction of the aileron [STICK].</p>



● FUNCTION AND DATA SETTING

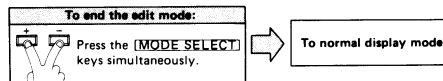

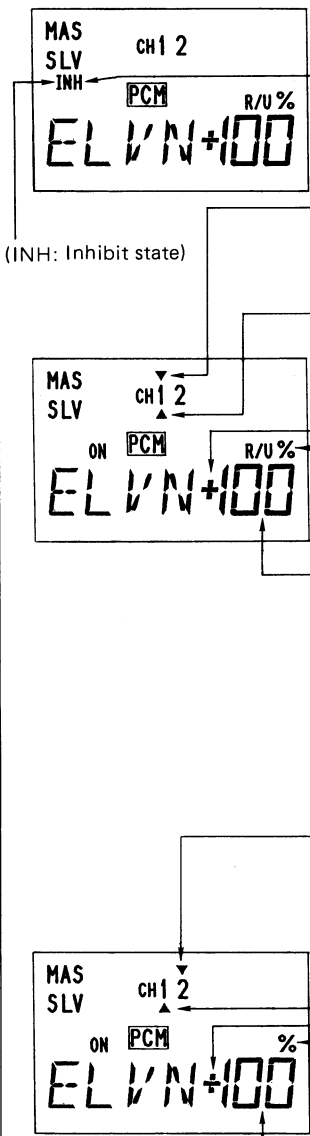
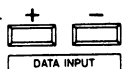
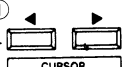
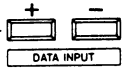
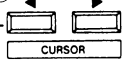
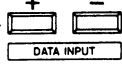
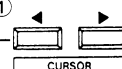
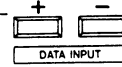
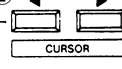
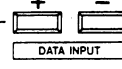
Function	Display	Data setting
<p>ELVN ACRO ELEVON</p> <p>This mixing can be used with delta wing aircraft.</p> <p>(Aileron operation) The left and right mixing rate of each servo can be set independently.</p> <p>(Elevator operation) The mixing rate of each servo can be set independently.</p> <p>● The operating channels are CH1 and CH2.</p>	 <p>(INH: Inhibit state)</p>	<p>1 Activate/inhibit mode setting</p> <p> Set the mode with the [DATA INPUT] keys. (+: Activate) (-: Inhibit)</p> <hr/> <p>2 Aileron setting (Master CH: CH1) (CH1 servo throw setting)</p> <p>①  Set the flashing display to "+" or "-" with the [CURSOR] keys. (Slave CH: CH1)</p> <p> Set the direction of operation with the [DATA INPUT] keys.</p> <p>②  Set the flashing display to "%" with the [CURSOR] keys.</p> <p> Set the mixing rate with the [DATA INPUT] keys.</p> <p>*Set each direction of the aileron [STICK].</p> <p>(CH2 servo throw setting) The same as the above. (Slave CH: CH2)</p> <hr/> <p>3 Elevator setting (Master CH: CH2) (CH1 servo throw setting)</p> <p>①  Set the flashing display to "+" or "-" with the [CURSOR] keys. (Slave CH: CH1)</p> <p> Set the direction of operation with the [DATA INPUT] keys.</p> <p>②  Set the flashing display to "%" with the [CURSOR] keys.</p> <p> Set the mixing rate with the [DATA INPUT] keys.</p> <p>(CH2 servo throw setting) The same as the above. (Slave CH: CH2)</p>

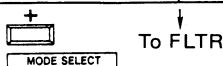

● FUNCTION AND DATA SETTING

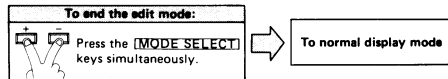

Function	Display	Data setting
<p>FLTR [ACRO] [GLID]</p> <p>FLAP TRIM</p> <p>FLAP TRIM (CH6) lever operation ↔ normal operation switching is possible.</p> <p>*For operation when FLAPERON is used, see the FLAPERON function item.</p> <p>[FLAP TRIM LEVER]</p> <p>CH6 FLAP TRIM</p>	<p>(INH: Normal operation)</p> <p>(ON: Trim operation)</p>	<p>1 Trim/normal mode setting</p> <p>Set the mode with the [DATA INPUT] keys.</p> <p>(+: Trim mode -: Normal mode)</p> <hr/> <p>2 Trim rate setting</p> <p>1 Set the flashing display to “%” with the [CURSOR] keys.</p> <p>2 Set the rate with the [DATA INPUT] keys. (When the + and - keys are pressed simultaneously, 30% is set.)</p>

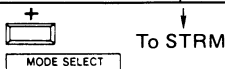

Function	Display	Data setting
<p>STRM [ACRO] [GLID]</p> <p>SUB TRIM</p> <p>Each channel neutral position can be adjusted.</p> <p>*One notch of the trim lever corresponds to a sub trim of about 6%.</p>		<p>1 CH selection</p> <p>Select the channel with the [CURSOR] keys.</p> <hr/> <p>2 Operating position setting</p> <p>Set the operating position with the [DATA INPUT] keys. (When the + and - keys are pressed simultaneously, 0% is set.)</p>

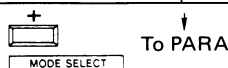

● FUNCTION AND DATA SETTING

To end the edit mode:
 Press the **MODE SELECT** keys simultaneously.

To normal display mode

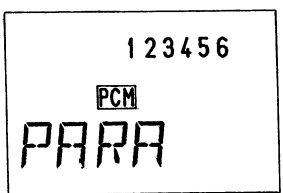
Function	Display	Data setting
<p>PARAMETER</p> <p>The following system data can be set.</p> <p>(“PARA” functions)</p> <ol style="list-style-type: none"> 1. Data reset 2. ATL trim ON/OFF 3. Combination switch 4. Programmable mixing switch 5. Mixing type 6. Modulation 		<p>The function is selected by the CURSOR keys in the “PARA” functions.</p>

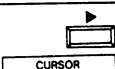
 To RSET

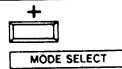
 To COPY

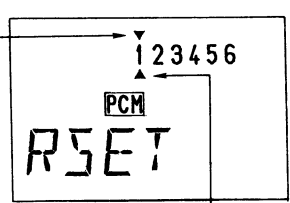
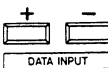
Function	Display	Data setting
<p>DATA RESET</p> <p>This function can be used to return programmed data to the original factory settings.</p>	 <p>Function No.</p> <p>Active model memory No.</p>	<p>1 Data reset</p> <p> Press the DATA INPUT keys (“+” and “-”) simultaneously.</p>

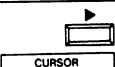
 To ATL

 To COPY

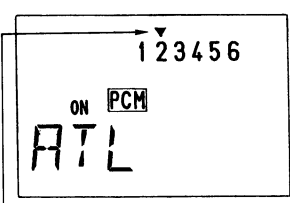
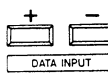
Function	Display	Data setting
<p>ATL TRIM ON/OFF</p> <p>ATL mode ON or OFF can be selected for throttle trim.</p>	 <p>Function No.</p>	<p>1 ATL mode setting</p> <p> Set the mode with the DATA INPUT keys. (+ : ATL mode ON) (- : ATL mode OFF)</p>

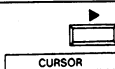
 To COMB

 To COPY

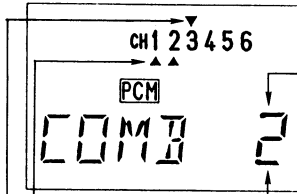
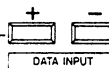

● FUNCTION AND DATA SETTING

To end the edit mode:
 Press the [MODE SELECT] keys simultaneously. → To normal display mode

Function	Display	Data setting								
<p>COMB COMBINATION SWITCH</p> <p>Other D/R switch functions can be linked by aileron [D/R SWITCH].</p> <ul style="list-style-type: none"> • Three modes can be set. <table border="1"> <thead> <tr> <th>Mode</th> <th>D/R switch to be linked</th> </tr> </thead> <tbody> <tr> <td>1</td> <td>AIL only</td> </tr> <tr> <td>2</td> <td>AIL, ELV</td> </tr> <tr> <td>3</td> <td>AIL, ELV, RUD</td> </tr> </tbody> </table>	Mode	D/R switch to be linked	1	AIL only	2	AIL, ELV	3	AIL, ELV, RUD	 <p>(Displays the channel No. of the D/R switch to be linked.)</p> <p>(Displays the mode No.) 1: Mode 1 2: Mode 2 3: Mode 3</p> <p>Function No.</p>	<p>1 Mode setting</p>  <p>Set the mode with the [DATA INPUT] keys.</p>
Mode	D/R switch to be linked									
1	AIL only									
2	AIL, ELV									
3	AIL, ELV, RUD									

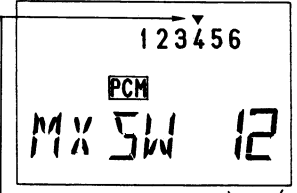
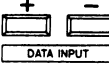
 To MXSW  To COPY

Function	Display	Data setting										
<p>MXSW PROGRAMMABLE MIXING SWITCH</p> <p>The mixing switch mode can be set.</p> <ul style="list-style-type: none"> • Four modes can be set. <table border="1"> <thead> <tr> <th>Mode</th> <th>Programmable mixing to be switched</th> </tr> </thead> <tbody> <tr> <td>12</td> <td>P·MIX 1 and 2</td> </tr> <tr> <td>1-</td> <td>P·MIX 1</td> </tr> <tr> <td>-2</td> <td>P·MIX 2</td> </tr> <tr> <td>--</td> <td>-</td> </tr> </tbody> </table>	Mode	Programmable mixing to be switched	12	P·MIX 1 and 2	1-	P·MIX 1	-2	P·MIX 2	--	-	 <p>Function No.</p> <p>Mode</p>	<p>1 Mode setting</p>  <p>Set the mode with the [DATA INPUT] keys.</p> <p>(+: Set the mode of P·MIX 1 with this key. -: Set the mode of P·MIX 2 with this key.)</p>
Mode	Programmable mixing to be switched											
12	P·MIX 1 and 2											
1-	P·MIX 1											
-2	P·MIX 2											
--	-											

 To (MIXING TYPE)  To COPY

● FUNCTION AND DATA SETTING

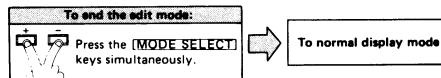

Function	Display	Data setting
<p>(MIXING TYPE)</p> <p>The mixing type can be selected.</p> <p>“ACRO”: For aircraft</p>		<p>1 Type selection</p> <p> Select the type with the [DATA INPUT] keys.</p>
<p>“GLID”: For glider</p>		<p>*When the mixing type is changed, the active model memory data is reset. (Except “HLI1” ↔ “HLI2”) However, the “MOD” function (PCM/PPM) is not reset.</p>
<p>“HLI1”: For helicopter (1 servo mode)</p>		
<p>“HLI2”: For helicopter (2 servo mode)</p>		
	Function No.	

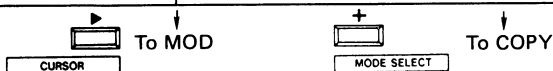

Function	Display	Data setting
<p>MOD MODULATION</p> <p>The modulation mode can be switched PCM ↔ PPM.</p> <p>*Select the PCM mode for the FP-7UAPS and the PPM mode for the FP-7UAFS.</p> <p>*When using the trainer function, select the same mode at the instructor side and student side.</p>	<p>When the display is changed, the display flashes. The actual transmit output at that time is the mode before the change.</p>	<p>1 Mode selection</p> <p> Select the mode with the [DATA INPUT] keys.</p> <p>*When the mode was switched, the transmitter power switch is turned off and transmit output is obtained the next time the transmitter power switch is turned on.</p>
	Function No.	

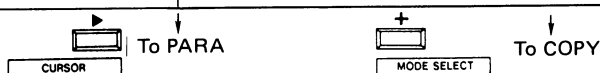

● FUNCTION AND DATA SETTING

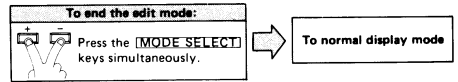

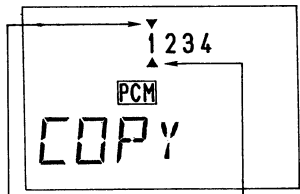
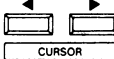
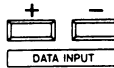
Function	Display	Data setting
<p>COPY <u>DATA COPY</u></p> <p>The active model memory data can be copied onto any model memory data.</p>	 <p>Active model memory</p> <p>Model memory that you wish to copy the data onto.</p>	<p>1 Model selection</p>  Select the model memory with the [CURSOR] keys. <hr/> <p>2 Copying</p>  Press the [DATA INPUT] keys ("+" and "-") simultaneously.

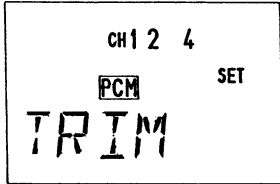
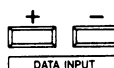

Function	Display	Data setting
<p>TRIM <u>TRIM MEMORY</u></p> <p>Each trim positions can be memorized, allowing the trim levers to be returned to neutral position.</p>		<p>1 Memorizing</p>  Press the [DATA INPUT] keys ("+" and "-") simultaneously. <p>*When the throttle trim is ATL mode, the trim position is not memorized.</p>

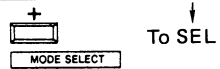

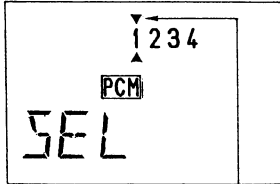
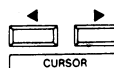
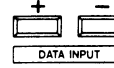
Function	Display	Data setting
<p>SEL <u>MODEL SELECT</u></p> <p>Anyone of the four models can be selected.</p>	 <p>Active model memory</p>	<p>1 Model selection</p>  Select the model with the [CURSOR] keys. <hr/> <p>2 Executing</p>  Press the [DATA INPUT] keys ("+" and "-") simultaneously.

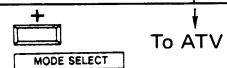



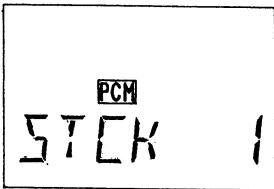

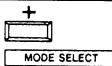
● FUNCTION AND DATA SETTING

Function	Display	Data setting
<p>STCK <u>STICK MODE SELECT</u></p> <p>(Usually this function is not used.)</p> <p>*This function is effective for all model memories.</p>		

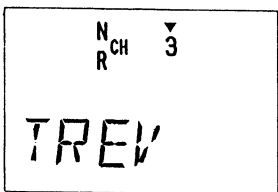

To TREV

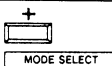

Function	Display	Data setting
<p>TREV <u>THROTTLE FUNCTION REVERSE</u></p> <p>The direction of the throttle operation can be reversed.</p> <p>*This function is effective for all model memories.</p>		<p>T Normal/reverse selection</p> <p>Set the direction with the   DATA INPUT keys.</p> <p> (+ : Normal side)  (- : Reverse side)</p>

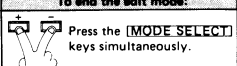

To STCK

● FUNCTION AND DATA SETTING

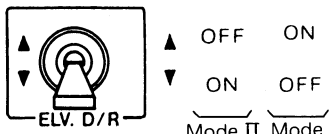
To end the edit mode:
 Press the [MODE SELECT] keys simultaneously. → To normal display mode

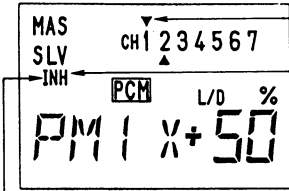
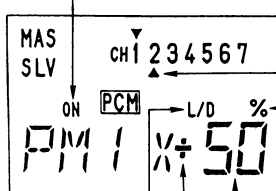
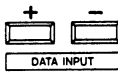
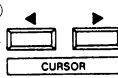
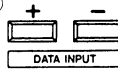
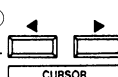
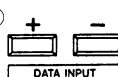
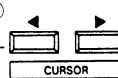
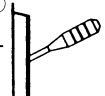
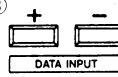
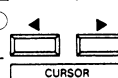
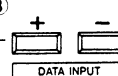
Function	Display	Data setting
<p>PMIX [HLI 1/2] PROGRAMMABLE MIXING</p> <p>This mixing is useful in correcting bad tendencies of the aircraft and in making operation more pleasant.</p> <ul style="list-style-type: none"> Mixing of any two channels is possible. The left and right (up and down) mixing rate can be set independently. Setting range 0 to 100% ↓ Mixing maximum <p>PMIX function [ON/OFF switch]</p>  <p>*The PMIX [ON/OFF switch] is also used as the ELV. [D/R switch]. To used it independently as the PMIX [ON/OFF switch] set the COMB function. Setting method </p>	 <p>(INH: Inhibit state)</p> <p>(Activate state ON: P.MIX switch ON OFF: P.MIX switch OFF)</p>  <p>(R/U: Right or up L/D: Left or down)</p>	<p>1 Mixing activate/inhibit mode setting</p> <p>Set the mode with the [DATA INPUT] keys.  (+: Activate) (-: Inhibit)</p> <hr/> <p>2 Master channel setting</p> <p>①  Set the flashing display to the "▼" mark with the [CURSOR] keys.</p> <p>②  Select the channel to be set with the [DATA INPUT] keys.</p> <hr/> <p>3 Slave channel selection</p> <p>①  Set the flashing display to the "▲" mark with the [CURSOR] keys.</p> <p>②  Select the channel to be set with the [DATA INPUT] keys.</p> <hr/> <p>4 Mixing servo direction of operation setting</p> <p>①  Set the flashing display to "+" (or "-") with the [CURSOR] keys.</p> <p>②  Held as long as the master channel stick (VR or switch) is in the R/U or L/D direction.</p> <p>③  Set the direction of operation with the [DATA INPUT] keys. (+: Normal direction) (-: Reverse direction)</p> <p>④ Set another direction by repeating steps ② and ③</p> <hr/> <p>5 Mixing rate setting</p> <p>①  Set the flashing display to "%" with [CURSOR] keys.</p> <p>② Set the same as ④ - ②</p> <p>③  Set the mixing rate with the [DATA INPUT] keys. (When the + and - keys are pressed simultaneously, 50% is set.)</p> <p>④ Set the same as ④ - ④</p>

 To T-NR

● FUNCTION AND DATA SETTING

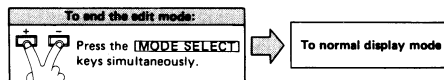

Function	Display	Data setting
<p>T-NR HLI 1/2 NORMAL THROTTLE CURVE</p> <p>At normal, the THROTTLE CURVE divides the full stroke of the [STICK] into four equal parts and allows adjustment of a total of five points.</p> <ul style="list-style-type: none"> Each point can be set over the 0 to 100% range. <p>This solid line shows the initial value.</p> <p>1 to 5: Setting point No.</p> <p>*Points are connected by a straight line.</p>	<p>(Indicates the current) (throttle stick position)</p> <p>(Setting point No.)</p> <p>(ON: Shows that this function is activated However, when the idle-up or throttle hold function is ON, "OFF" is displayed.)</p>	<p>1 Setting of each point</p> <p>① Set the point No. to be set with the [CURSOR] keys.</p> <p>② Set to the desired operating position with the [DATA INPUT] keys. (When the + and - keys are pressed simultaneously, the operating position is set to the initial value.)</p> <p>③ Set for a different point by repeating steps ① and ②.</p>

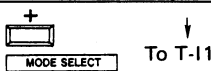

● FUNCTION AND DATA SETTING

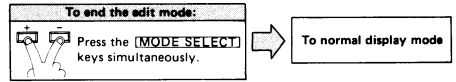

Function	Display	Data setting
T-11 HLI 1/2 IDLE-UP 1 THROTTLE CURVE The THROTTLE CURVE can be set at IDLE-UP 1 function operation. <ul style="list-style-type: none"> • The throttle servo hold position can be set. • Setting range: -100 (low side) - +100% (high side) IDLE-UP function [ON/OFF switch] 		<ol style="list-style-type: none"> 1 Activate/inhibit mode setting Set the mode with the [DATA INPUT] keys. (+: Activate) (-: Inhibit) 2 Setting each point <ol style="list-style-type: none"> 1 Set the point No. to be set with the [CURSOR] keys. 2 Set the desired operating position with the [DATA INPUT] keys. (When the + and - keys are pressed simultaneously, the operating position is set to the initial value.) 3 Set for a different point by repeating steps ① and ②.



Function	Display	Data setting
T-12 HLI 1/2 IDLE-UP 2 THROTTLE CURVE The THROTTLE CURVE can be set at IDLE-UP 2 function operation. <ul style="list-style-type: none"> • The throttle servo hold position can be set. • Setting range: -100 (low side) - +100% (high side) IDLE-UP function [ON/OFF switch] 		<ol style="list-style-type: none"> 1 Activate/inhibit mode setting Set the mode with the [DATA INPUT] keys. (+: Activate) (-: Inhibit) 2 Setting each point <ol style="list-style-type: none"> 1 Set the point No. to be set with the [CURSOR] keys. 2 Set the desired operating position with the [DATA INPUT] keys. (When the + and - keys are pressed simultaneously, the operating position is set to the initial value.) 3 Set for a different point by repeating steps ① and ②.

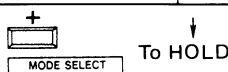

● FUNCTION AND DATA SETTING

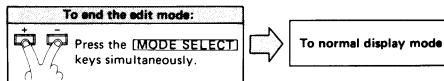

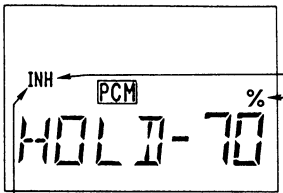
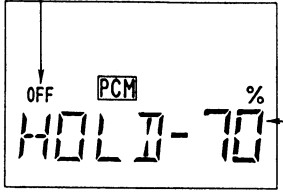
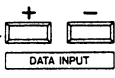
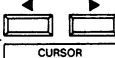
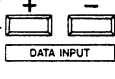
Function	Display	Data setting
HOLD [HLI1/2] THROTTLE HOLD This function stops the throttle servo during auto rotation. • The throttle servo hold position can be set. • Setting range: -100 (low side) - +100% (high side) THROTTLE HOLD function [ON/OFF switch] 	 (INH: Shows that the THROTTLE HOLD function is inhibited.) (THROTTLE HOLD activate) ON: [ON/OFF switch] ON OFF: [ON/OFF switch] OFF 	1 Activate/inhibit mode setting  Set the mode with the [DATA INPUT] keys. (+: Activate) (-: Inhibit) 2 Throttle servo hold position setting ①  Set the flashing display to the "%" with the [CURSOR] keys. ②  Set the hold position with the [DATA INPUT] keys. (When the + and - keys are pressed simultaneously, the hold position is set to -70%.)

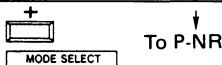

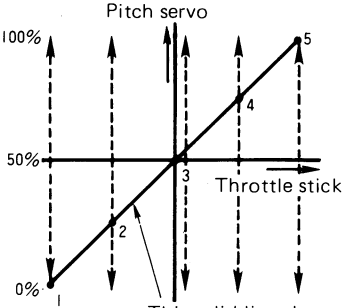
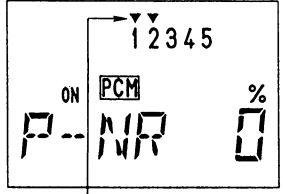
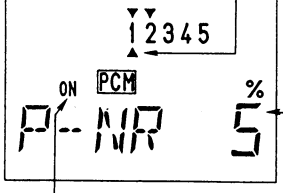
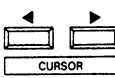
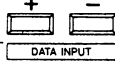
Function	Display	Data setting
P-NR [HLI1/2] NORMAL PITCH CURVE The PITCH CURVE divides the full stroke of the [STICK] into four equal parts and allows adjustment of five points. • Each point can be set from 0 to 100%.  This solid line shows the initial value. 1 - 5: Setting point No. *1 Each point is connected by a straight	 (Indicates the current throttle stick position) (Setting point No.)  (ON: Shows that this function is activated) However, when the idle-up or throttle hold function is ON, "OFF" is displayed.	1 Setting each point ①  Set to the point No. to be set with the [CURSOR] keys. ②  Set the desired operating position with the [DATA INPUT] keys. (When the + and - keys are pressed simultaneously, the operating position is set to the initial value.) ③ Set for a different point by repeating steps ① and ②.

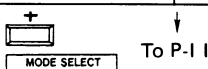

● FUNCTION AND DATA SETTING

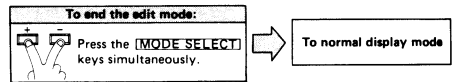

Function	Display	Data setting
<p>P-11 HLI 1/2 IDLE UP 1 PITCH CURVE</p> <p>The PITCH CURVE at IDLE-UP 1 function operation can be set.</p> <p>(The setting points and setting range are the same as the NORMAL PITCH CURVE.)</p> <p>IDLE-UP function ON/OFF switch</p>	<p>(Indicates the current throttle stick position.)</p> <p>(Setting point No.)</p>	<p>1 Setting each point</p> <p>① Set to the point No. to be set with the [CURSOR] keys.</p> <p>② Set to the desired operating position with the [DATA INPUT] keys. (When the + and - keys are pressed simultaneously, the operating position is set to the initial value.)</p> <p>③ Set for a different point by repeating steps ① and ②</p>

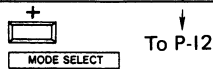

Function	Display	Data setting
<p>P-12 HLI 1/2 IDLE UP 2 PITCH CURVE</p> <p>The PITCH CURVE at IDLE-UP 2 function operation can be set.</p> <p>(The setting points and setting range are the same as the NORMAL PITCH CURVE.)</p> <p>IDLE-UP function ON/OFF switch</p>	<p>(Indicates the current throttle stick position.)</p> <p>(Setting point No.)</p>	<p>1 Setting each point</p> <p>① Set to the point No. to be set with the [CURSOR] keys.</p> <p>② Set to the desired operating position with the [DATA INPUT] keys. (When the + and - keys are pressed simultaneously, the operating position is set to the initial value.)</p> <p>③ Set for a different point by repeating steps ① and ②</p>

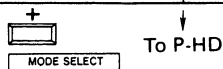



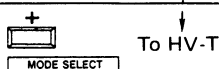

Function	Display	Data setting
<p>P-HD HLI 1/2 HOLD PITCH CURVE</p> <p>The PITCH CURVE at THROTTLE HOLD function operation can be set.</p> <p>(The setting points and setting range are the same as NORMAL PITCH CURVE.)</p> <p>THROTTLE HOLD function ON/OFF switch</p>	<p>(Shows the current throttle stick position)</p> <p>(Setting point No.)</p>	<p>1 Setting each point</p> <p>① Set to the point No. to be set with the [CURSOR] keys.</p> <p>② Set to the desired operating position with the [DATA INPUT] keys. (When the + and - keys are pressed simultaneously, the operating position is set to the initial value.)</p> <p>③ Set for a different point by repeating steps ① and ②.</p>

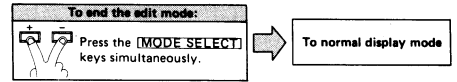

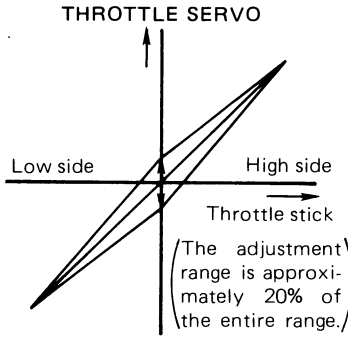

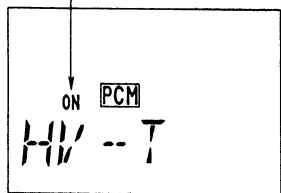
● FUNCTION AND DATA SETTING



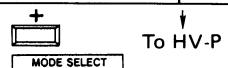

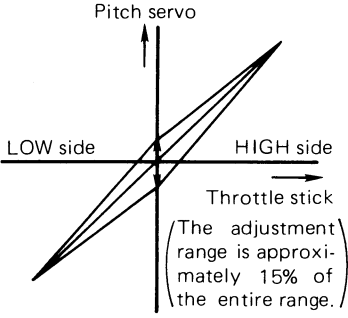
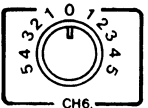
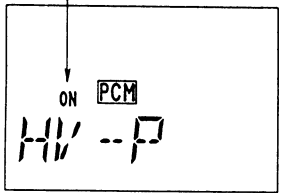
Function	Display	Data setting
<p>HV-T HLI 1/2 HOVERING THROTTLE</p> <p>This is the throttle trim function near the hovering point.</p>  <p>THROTTLE SERVO</p> <p>Low side High side</p> <p>Throttle stick</p> <p>(The adjustment range is approximately 20% of the entire range.)</p> <p>HOVERING THROTTLE KNOB</p>  <p>CH. 7</p>	<p>(ON: Shows that this function is activated INH: Shows that this function is inhibited)</p> 	<p>1 Activate/inhibit setting</p> <p>  Set the mode with the [DATA INPUT] keys. (+: Activate) (-: Inhibit)</p>



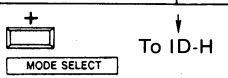



Function	Display	Data setting
<p>HV-P HLI 1/2 HOVERING PITCH</p> <p>This is the pitch trim function near the hovering point.</p>  <p>Pitch servo</p> <p>LOW side HIGH side</p> <p>Throttle stick</p> <p>(The adjustment range is approximately 15% of the entire range.)</p> <p>HOVERING PITCH KNOB</p>  <p>CH. 6</p>	<p>(ON: Shows that this function is activated INH: Shows that this function is inhibited)</p> 	<p>1 Activate/inhibit mode setting</p> <p>  Set the mode with the [DATA INPUT] keys. (+: Activate) (-: Inhibit)</p>



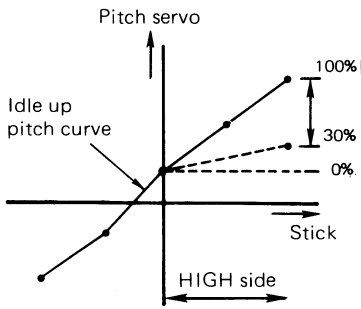
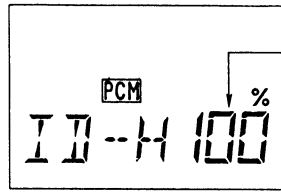



● FUNCTION AND DATA SETTING

To end the edit mode:
 Press the **MODE SELECT** keys simultaneously.  To normal display mode

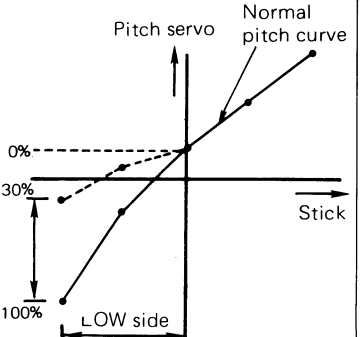
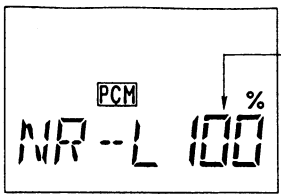
Function	Display	Data setting
<p>ID-H HLI1/2 IDLE UP HIGH PITCH</p> <p>The HIGH side pitch rate at IDLE-UP function operation can be set.</p>  <p>• Setting range: 30% to 100%</p> <p>*When not using this function, set the rate to 100%.</p>		<p>1 Rate setting</p> <p>  Set the rate with the DATA INPUT keys. DATA INPUT (When the + and - keys are pressed simultaneously, the rate is set to 100%.)</p>

  To NR-L
MODE SELECT

Function	Display	Data setting
<p>NR-L HLI1/2 NORMAL LOW PITCH</p> <p>The LOW side pitch rate at normal can be set.</p>  <p>• Setting range: 30 to 100%</p> <p>*When not using this function, set the rate to 100%.</p>		<p>1 Rate setting</p> <p>  Set the rate with the DATA INPUT keys. DATA INPUT (When the + and - keys are pressed simultaneously, the rate is set to 100%.)</p>

  To REVO
MODE SELECT

● FUNCTION AND DATA SETTING

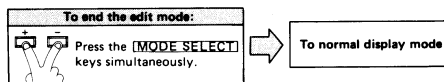

Function	Display	Data setting																		
<p>REVO HLI1/2 REVOLUTION MIXING</p> <p>This function is used to cancel the reaction torque of the rotor at pitch → rudder mixing.</p> <ul style="list-style-type: none"> The mixing direction is changed with the direction of rotation of the main rotor. The mixing rate can be set separately for the HIGH side and LOW side of the [THROTTLE STICK]. Setting range: 0 to 100% ↓ Mixing maximum The mixing ON/OFF can be set at throttle hold. 	<p>ON: Shows that this function is activated INH: Shows that this function is inhibited</p> <p>(R/U: LOW side) (L/D: HIGH side)</p>	<p>1 Activate/inhibit setting</p> <p>Set the mode with the [DATA INPUT] keys. (+: Activate) (-: Inhibit)</p> <hr/> <p>2 Mixing direction setting</p> <p>① Set the flashing display to the side of the rate with the [CURSOR] keys.</p> <p>② Set the direction with the [DATA INPUT] keys.</p> <table border="1"> <thead> <tr> <th>Main rotor direction of rotation</th> <th>[DATA INPUT] key</th> <th>Display</th> </tr> </thead> <tbody> <tr> <td>Clockwise</td> <td>-</td> <td>-</td> </tr> <tr> <td>Counterclockwise</td> <td>+</td> <td>+</td> </tr> </tbody> </table> <hr/> <p>3 Mixing rate setting</p> <p>① Set the flashing display to the “%” with the [CURSOR] keys.</p> <p>② Throttle stick held at the HIGH side.</p> <p>③ Set the mixing rate with the [DATA INPUT] keys. (When the + and - keys are pressed simultaneously, the rate is set to 50%.)</p> <p>④ Set for the throttle stick LOW side by holding the throttle stick at the LOW side and repeating step ③.</p> <hr/> <p>4 ON/OFF setting at throttle hold</p> <p>① Set the flashing display to “12” with the [CURSOR] keys.</p> <p>② Set the mode with the [DATA INPUT] keys.</p> <table border="1"> <thead> <tr> <th>Mixing</th> <th>[DATA INPUT] key</th> <th>Display</th> </tr> </thead> <tbody> <tr> <td>OFF</td> <td>-</td> <td>1</td> </tr> <tr> <td>ON</td> <td>+</td> <td>2</td> </tr> </tbody> </table>	Main rotor direction of rotation	[DATA INPUT] key	Display	Clockwise	-	-	Counterclockwise	+	+	Mixing	[DATA INPUT] key	Display	OFF	-	1	ON	+	2
Main rotor direction of rotation	[DATA INPUT] key	Display																		
Clockwise	-	-																		
Counterclockwise	+	+																		
Mixing	[DATA INPUT] key	Display																		
OFF	-	1																		
ON	+	2																		

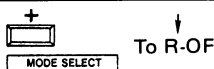

● FUNCTION AND DATA SETTING

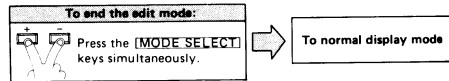

Function	Display	Data setting									
<p>R-OFF HLI1/2 RUDDER OFFSET</p> <p>Pitch → rudder mixing can be disconnected and the neutral position for flight can be set separately from rudder trim.</p> <ul style="list-style-type: none"> Setting range: -100 to +100% [ON/OFF switch] can be selected. [IDLE-UP SWITCH] (when IDLE-UP function set) or [CH5 SWITCH] <p>RUDDER OFFSET function [ON/OFF switch]</p> <p>(IDLE-UP ON/OFF switch)</p> <p>or</p> <p>(ON)</p> <p>(OFF)</p> <p>*However, when the INVERTED FLIGHT function is used, RUDDER OFFSET is turned on and off by [IDLE-UP switch] without regard to [ON/OFF switch] selection.</p>	<p>(ON/OFF switch mode No.)</p> <p>(INH: Shows that this function is inhibited.)</p> <p>(Activate state ON: [ON/OFF switch] ON OFF: [ON/OFF switch] OFF)</p>	<p>1 Activate/inhibit setting</p> <p>Set the mode with the [DATA INPUT] keys. (+ : Activate) (- : Inhibit)</p> <hr/> <p>2 Offset rate setting</p> <p>① Set the flashing display to “%” with the [CURSOR] keys.</p> <p>② Set the offset rate with the [DATA INPUT] keys. (When the + and - keys are pressed simultaneously, the rate is set to 0%.)</p> <hr/> <p>3 ON/OFF switch selection</p> <p>① Set the flashing display to the “▲” of the [ON/OFF switch] mode No. with the [CURSOR] keys.</p> <p>② Select the [ON/OFF switch] mode No. with the [DATA INPUT] keys.</p> <table border="1"> <thead> <tr> <th>Mode</th> <th>[ON/OFF switch]</th> <th>[DATA INPUT] key</th> </tr> </thead> <tbody> <tr> <td>1</td> <td>IDLE UP</td> <td>-</td> </tr> <tr> <td>2</td> <td>CH5</td> <td>+</td> </tr> </tbody> </table>	Mode	[ON/OFF switch]	[DATA INPUT] key	1	IDLE UP	-	2	CH5	+
Mode	[ON/OFF switch]	[DATA INPUT] key									
1	IDLE UP	-									
2	CH5	+									

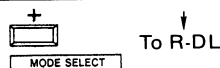

● FUNCTION AND DATA SETTING

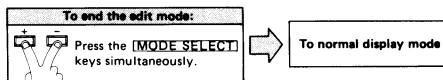

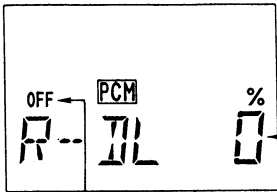
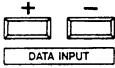
Function	Display	Data setting
<p>R-DL [HLI 1/2] RUDDER OFFSET DELAY</p> <p>The operating speed of the rudder servo at rudder offset function ON/OFF can be varied.</p> <ul style="list-style-type: none"> Setting range: 0 to 100% ↓ MAX (4% steps) 	 <p>(Indicates the rudder offset function setting state.)</p>	<p>1 Delay rate setting</p> <p> Set the delay rate with the [DATA INPUT] keys. (When the + and - keys are pressed simultaneously, the rate is set to 0%.)</p>

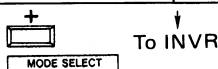

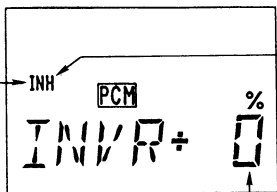
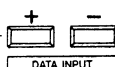
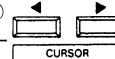
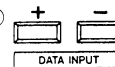
Function	Display	Data setting
<p>INVR [HLI 1/2] INVERTED FLIGHT</p> <p>This function performs inverted flight by normal flight stick operation. Forward flight can be set when normal.</p> <ul style="list-style-type: none"> The cross rate can be set. <p>*At inverted flight, the direction of the elevator and rudder servos is reversed.</p> <p>INVERTED FLIGHT function [SWITCH]</p> <p>(Normal)  P.MIX. (Invert)</p>	 <p>(INH: Shows that this function is inhibited)</p> <p>(Invert mode ON: Inverted flight OFF: Normal flight)</p>	<p>1 Activate/inhibit setting</p> <p> Select the mode with the [DATA INPUT] keys. (+: Activate) (-: Inhibit)</p> <p>2 Cross rate setting</p> <p>1  Set the flashing display to "%" with the [CURSOR] keys.</p> <p>2  Set the point with the [DATA INPUT] keys. (When the + and - keys are pressed simultaneously, the point is set to 0%.)</p>

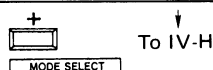

● FUNCTION AND DATA SETTING

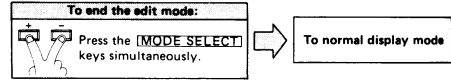

Function	Display	Data setting
IV-H HLI1/2 INVERT HIGH PITCH The HIGH pitch rate at inverted flight can be adjusted. • Setting range: 30 to 100%		1 Rate setting Set the rate with the [DATA INPUT] keys. (When the + and - keys are pressed simultaneously, the rate is set to 100%.)



Function	Display	Data setting
IV-L HLI1/2 INVERT LOW PITCH The LOW pitch rate at inverted flight can be adjusted. • Setting range: 30 to 100%.		1 Rate setting Set the rate with the [DATA INPUT] keys. (When the + and - keys are pressed simultaneously, the rate is set to 100%.)

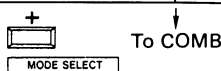

● FUNCTION AND DATA SETTING

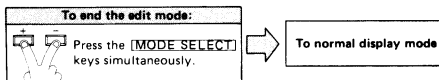

Function	Display	Data setting
<p>STAT GLID START MIXING</p> <p>This mixing is the offset mixing of the elevator, flap and aileron servos.</p> <p>This mixing may be used when taking off.</p> <p>ON/OFF SWITCH</p>	<p>(INH: Inhibit state)</p>	<p>① Activate/inhibit mode setting</p> <p>Set the mode with the DATA INPUT keys. + (+: Activate) - (-: Inhibit)</p> <hr/> <p>② Each servo throw setting</p> <p>① Set the flashing display to "%" with the CURSOR keys.</p> <p>② Set the servo throw with the DATA INPUT keys. (When the "+" and "-" keys are pressed simultaneously, 0% is set.)</p>

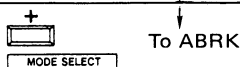

Function	Display	Data setting
<p>VTAL GLID V-TAIL MIXING</p> <p>This mixing serves to control the combined elevators and rudders of V-tail models.</p> <p>The rate of the elevator and rudder can be set independently.</p> <ul style="list-style-type: none"> The operating channels are CH2 and CH4. 	 	<p>① Activate/inhibit mode setting</p> <p>Set the mode with the DATA INPUT keys. + (+: Activate) - (-: Inhibit)</p> <hr/> <p>② Elevator setting (Master CH: CH2) (CH2 servo throw setting)</p> <p>① Set the flashing display to "+" or "-" with the CURSOR keys. (Slave CH: CH2)</p> <p>+ - Set the direction of operation with the DATA INPUT keys.</p> <p>② Set the flashing display to "%" with the CURSOR keys.</p> <p>+ - Set the mixing rate with the DATA INPUT keys.</p> <p>(CH4 servo throw setting)</p> <p>③ The same as the above. (Slave CH: CH4)</p> <hr/> <p>③ Rudder setting (Master CH: CH4) The same as the above. (② ① - ③)</p>

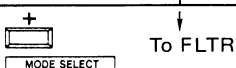

● OTHER FUNCTIONS

■ Stick lever tension adjustment

1 Remove the transmitter back cover.

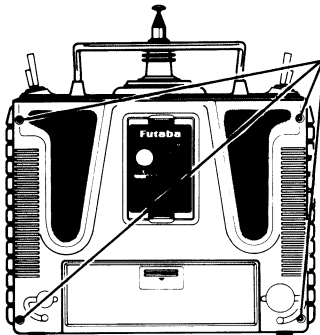

Remove the four screws and remove the back cover.

2 Adjust the spring strength.

Elevator (MODE II)

Aileron

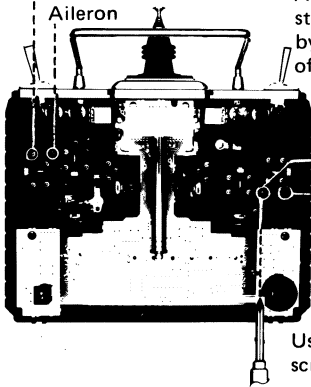

An arbitrary spring strength is obtained by turning the screw of each stick.

Rudder

Elevator (MODE I)

Use a small Phillips screwdriver.

■ Non-slip adjustable lever head adjustment

The length of the lever head can be changed.

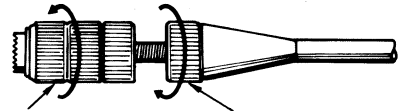

Lever head (A)

Lever head (B)

Unlock lever heads (A) and (B) by turning them in opposite directions as shown by the arrows and adjust the stick to the most comfortable length.

■ Receiver B.F/S function

When the receiver battery voltage drops below a certain value, the throttle servo moves to a preset position. (B.F/S mode)

At this time, reset the B.F/S mode and immediately land the aircraft.

B.F/S mode position setting

- Set the throttle channel (CH3) to the F/S function.
Setting method [P.10](#)
- The set position should be close to maximum slow.

B.F/S mode resetting method

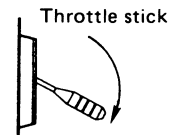

- When the throttle stick is set to the maximum slow position, the B.F/S mode is reset.

■ Trainer function (Trainer cable optional)

1 Connection to transmitter

Trainer switch

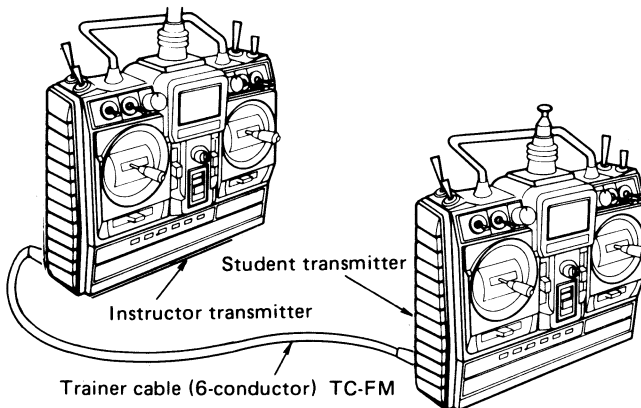

*Operation is impossible if the instructor transmitter modulation mode and student transmitter modulation mode is different. Set to the same mode before using. Setting method [P.23](#)

*Always turn off the student transmitter power switch. Do not operate the trainer switch either.

*Use the functions of the other two transmitters with the same setting.

2 Operating at the instructor side

Operation is possible by turning on the instructor transmitter power switch. At this time, turn off the trainer switch.

3 Operating at the student side

Operation is possible at the student transmitter while the trainer switch at the instructor side is held in the ON state.

■ SPLINED HORNS

The splined horns allow adjustment of the servo neutral position at the servo horn.

Neutral position adjustment

a) Angle divisions

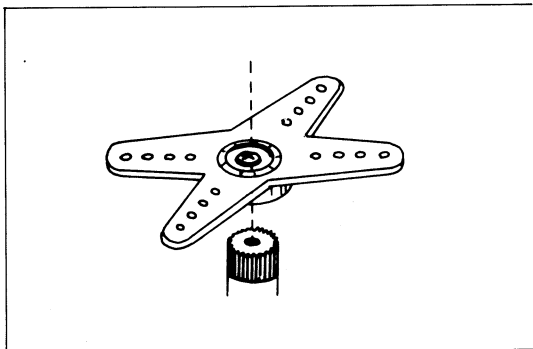

- 1) The splined horn has 25 segments. The amount of change per segment is; $360 \div 25 = 14.4^\circ$.
- 2) The minimum adjustable angle is determined by the number of arms or number of holes. For four arms, the minimum adjustable angle is:

$$360^\circ \div \frac{(25 \times 4)}{\text{Number of divisions}} = 3.6^\circ$$

b) Effect

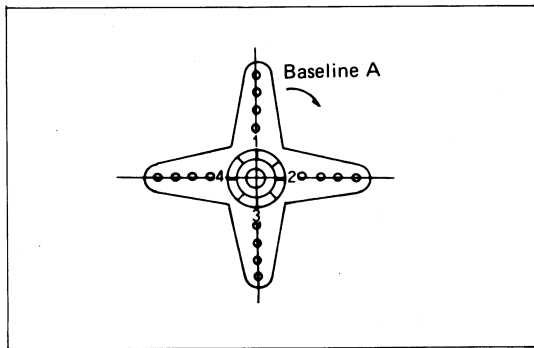

To shift the holes center line to the right (clockwise) relative to baseline A, shift arm 2 to the position of arm 1 and set it to the position closest to baseline A.

(Example) For a four arm horn, the angular shift per segment is 14.4° . The shift to the right is: $90^\circ - (14.4 \times 6) = 3.6^\circ$

To shift by the same angle in the opposite direction, use the opposite arm number.

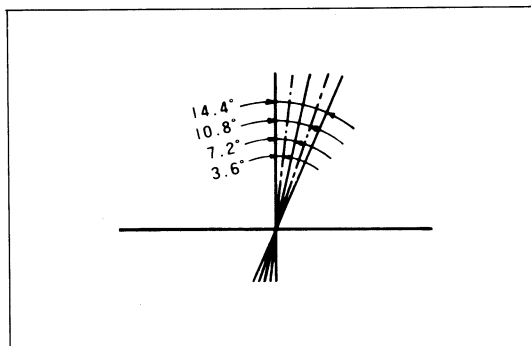

For a six arm horn, turn the arm counterclockwise and set arm 2 to the position of arm 1.

The adjustable angle is $60 - (14.4 \times 4) = 2.4^\circ$.

Arm 3 shifts 4.8° to the right, arm 6 shifts 2.4° to the left, and arm 4 shifts 7.2° to the right and left.

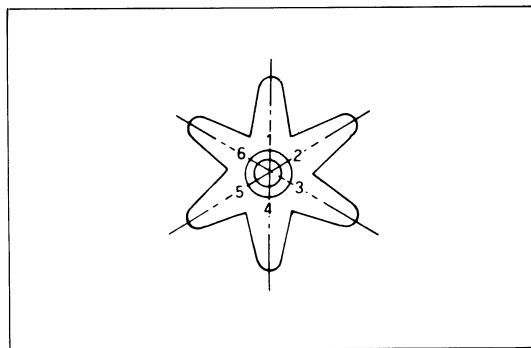

The following splined horns are optional.

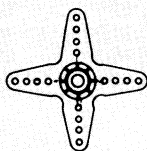

HORN A
(FSH-6X)

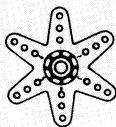

HORN B
(FSH-6S)



HORN C
(FSH-6R)



HORN D
(FSH-6W)



HORN E

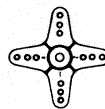

HORN F

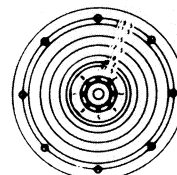

HORN G

● USING THE ACCESSORIES

■ Digital Proportional Frequencies (FOR U.S.A.)

- The frequency of Futaba digital proportional sets can be changed within their own band. There are 2 different bands for you to choose from (27 MHz and 75 MHz.) Please see chart listed below for specific frequency and its intended use. Please note there are specific frequencies allocated for aircraft only and surface only use.
- The frequency can be changed within the same BAND by using a precisely matched pair of Futaba crystals. However, Futaba recommends that you return your system to our factory service department for frequency changing, as tuning may be necessary for proper operation. Changing frequency from one band to another is NOT possible.
- Always change frequency flag when frequency is changed. The frequency flag is to be attached to the top of antenna and the channel designation to the base. (See Drawing)
- It is illegal to change crystals on 75 MHz bands in the U.S.A.

■ ANTENNA FREQUENCY FLAG

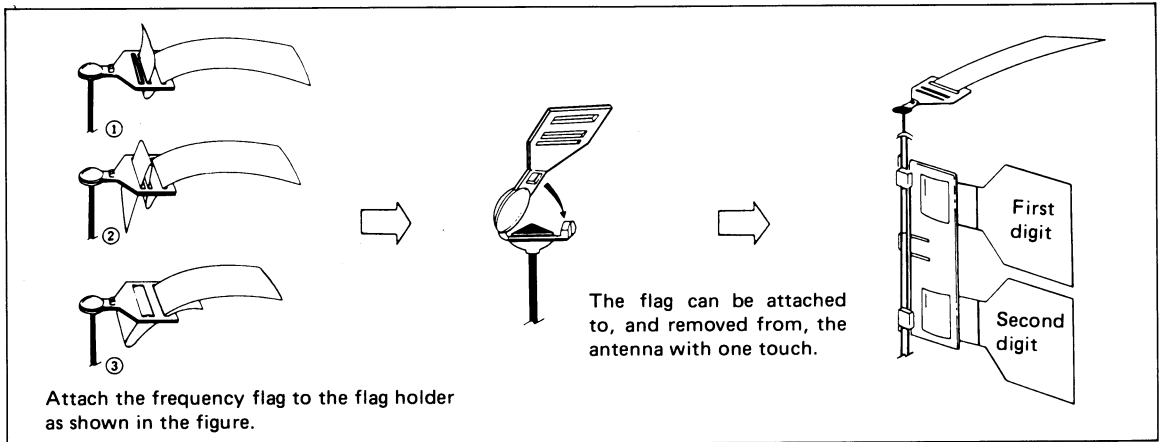

■ Frequency Channel No. Flag Color (FOR U.S.A.)

26-27 MHz – Aircraft/car/boat		72 MHz – Aircraft only		75 MHz – Car/Boat only	
	Color	72.030	12	*72.470	34
26.995	Brown	*72.070	14	72.550	38
27.045	Red	*72.110	16	72.590	40
27.095	Orange	*72.150	18	72.630	42
27.145	Yellow	*72.190	20	72.670	44
27.195	Green	*72.230	22	72.710	46
27.255	Blue	*72.270	24	72.750	48
		*72.310	26	72.790	50
		*72.350	28	72.830	52
		*72.390	30	72.870	54
		*72.430	32	72.910	56
50/53 MHz – Aircraft/car boat – Fcc Amature License required (2 and 3 channels not produced on these frequencies.)					
	Channel No.	75.430	62	75.750	78
50.800	RC00	75.470	64	75.790	80
50.840	RC02	75.510	66	75.830	82
50.880	RC04	75.550	68	75.870	84
50.920	RC06	75.590	70	*75.910	86
50.960	RC08	*75.630	72	*75.950	88
	Color	75.670	74	*75.990	90
53.100	Black-Brown	75.710	76		
53.200	Black-Red				
53.300	Black-Orange				
53.400	Black-Yellow				
53.500	Black-Green				
53.600	Black-Blue				
53.700	Black-Violet				
53.800	Black-Gray				

* Effective JAN 1, 1988

● SUMMARY OF PROGRAMMES

Mixing type "ACRO"

FUNCTION	SETTING POINT	INITIAL VALUE	SETTING RANGE	REMARK	
ATV ADJUSTABLE TRAVEL VOLUME	Each CH Left/right (up/down)	100%	30~120%		
D/R DUAL RATE	AIL, ELE, RUD. Each direction of the D/R switch	100%	30~120%	Related func. → "COMB" func.	
EXP EXPONENTIAL	AIL, ELE, THR, RUD. Each direction of the D/R switch	0%	-100~+100%	No D/R switch for the THR.	
REV REVERSE	Each CH	Normal side "N"	"N"; Normal "R"; Reverse		
F/S FAIL SAFE	Each CH	INH/ACT F/S position	OFF (HOLD) 50%	OFF, F/S 0~100%	
PMX1 PROGRAMMABLE MIXING 1	Between any two channels Left/right (up/down)	INH/ACT CH selection Mixing amount	INH (Master CH) (Slave CH) CH1 CH2 +50%	INH, ON/OFF CH1~7 ±0~100%	
PMX2 PROGRAMMABLE MIXING 2	(The same as the above.)				
2 → 6 ELE. → FLP. MIXING	ELE. Up/down	INH/ACT Mixing amount	INH +50%	INH, ON/OFF ±0~100%	
ABRK AIR BRAKE MIXING	FLP. ELE. AIL.	INH/ACT Position	INH 0%	INH, ON/OFF -100~+100%	(Mixing mode) "OFF"; offset "On"; linear
1 → 4 AIL. → RUD. MIXING	AIL. Left/right	INH/ACT Mixing amount	INH +50%	INH, ON ±0~100%	(Mode) "1"; always "ON" "2"; RUD D/R SW
SNP SNAP-ROLL	4 SNAP-ROLL directions AIL, ELE, RUD.	INH/ACT Position SAFETY mode	INH (AIL.) (ELE.) (RUD.) (R/U) +100% +100% +100% (R/D) +100% -100% -100% (L/U) -100% +100% -100% (L/D) -100% -100% +100%	INH, ON/OFF 0~120% 0~120% 0~120% 0~120%	
DIFF AILERON DIFFERENTIAL	AIL. (CH7, 1) Left/right	INH/ACT Mixing amount	INH +100%	INH, ON ±0~100%	DIFF and FLAP-ERON cannot be on simultaneously. The function turned on last has priority.
FLPR FLAPERON	AIL. (CH6, 1) Left/right FLP. (CH6, 1)	INH/ACT Mixing amount	INH (CH1) (CH6) (AIL. R) +100% +100% (AIL. L) +100% +100% (FLP.) +100% -100%	INH, ON ±0~100%	
ELVN ELEVON	AIL. (CH2, 1) Left/right ELE. (CH2, 1)	INH/ACT Mixing amount	INH (CH1) (CH2) (AIL. R) +100% +100% (AIL. L) +100% +100% (ELE.) +100% -100%	INH, ON ±0~100%	
FLTR FLAP TRIM	FLAP TRIM	INH/ACT Mixing amount	INH 30%	INH, ON 0~100%	
STRM SUB TRIM	Each CH		0%	-100~+100%	
PARA PARAMETER	(See the following functions; "RSET"~"MOD" function)				
RSET DATA RESET	All setting data in the active model memory		-	In the active model memory	
ATL ATL TRIM ON/OFF	THR. trim		ON	ON, OFF	
COMB COMBINATION SWITCH	AIL. D/R switch		MODE "1"	MODE "1"~"3"	Related func. → "D/R" func.
MXSW PROGRAMMABLE MIXING SWITCH	Each programmable mixing switch		MODE "12"	MODE "12", "1", "2"	
(MIXING TYPES)	"ACRO", "GLID", "HL11", "HL12"		"ACRO"	"ACRO", "GLID", "HL11", "HL12"	
MOD MODULATION	PCM/PPM		MODE "C" (PCM)	"C"; PCM "F"; PPM	
COPY DATA COPY	Each model memory		-	Model memory 1~4	
TRIM TRIM MEMORY	All stick CH trims		-	CH1~4	Except the ATL trim for THR.
SEL MODEL SELECT	Each model memory		-	Model memory 1~4	
STCK STICK MODE SELECT	(Usually this function is not used.)				Their functions are effective in all model memories.
TREV THROTTLE FUNCTION REVERSE	THR.		Normal side ("N")	"N"; Normal "R"; Reverse	

SUMMARY OF PROGRAMMES

Mixing type "HLI1" "HLI2"

FUNCTION	SETTING POINT	INITIAL VALUE	SETTING RANGE	REMARK	
ATV ADJUSTABLE TRAVEL VOLUME	Each CH Left/right (up/down)	100%	30~120%		
D/R DUAL RATE	AIL, ELE, RUD, Each direction of the D/R switch	100%	30~120%	Related func. → "COMB" func.	
EXP EXPONENTIAL	AIL, ELE, THR, RUD, Each direction of the D/R switch	0%	-100~+100%	No D/R switch for the THR.	
REV REVERSE	Each CH	Normal side "N"	"N"; Normal "R"; Reverse		
F/S FAIL SAFE	Each CH	INH/ACT F/S position	OFF (HOLD) 50%	OFF, F/S 0~100%	
PMX PROGRAMMABLE MIXING	Between any two channels Left/right (up/ down)	INH/ACT CH selection Mixing amount	INH (Master CH) (Slave CH) 1CH 2CH +50%	INH, ON/OFF CH1~7 ±0~100%	
T-NR NORMAL THROTTLE CURVE	THR. curve	(Point) Amount	(1) (2) (3) (4) (5) 0% 25% 50% 75% 100%	0~100%	
T-I1 IDLE-UP 1 THROTTLE CURVE	THR. curve	INH/ACT (Point) Amount	INH (1) (2) (3) (4) (5) 0% 25% 50% 75% 100%	INH, ON/OFF 0~100%	
T-I2 IDLE-UP 2 THROTTLE CURVE	THR. curve	INH/ACT (Point) Amount	(The same as the above.)		
HOLD THROTTLE HOLD	THR.	INH/ACT Position	INH -70%	INH, ON/OFF -100~+100%	
P-NR NORMAL PITCH CURVE	PIT. curve	(Point) Amount	(1) (2) (3) (4) (5) 0% 25% 50% 75% 100%	0~100%	
P-I1 IDLE-UP 1 PITCH CURVE	PIT. curve	(Point) Amount	(The same as the above.)		
P-I2 IDLE-UP 2 PITCH CURVE	PIT. curve	(Point) Amount	(The same as the above.)		
P-HD THROTTLE HOLD PITCH CURVE	PIT. curve	(Point) Amount	(The same as the above.)		
HV-T HOVERING THROTTLE	Throttle trim function at the hovering point		ON	ON, INH	
HV-P HOVERING PITCH	Pitch trim function at the hovering point		ON	ON, INH	
ID-H IDLE-UP HIGH PITCH	PIT. rate		100%	30~100%	
NR-L NORMAL LOW PITCH	PIT. rate		100%	30~100%	
REVO REVOLUTION MIXING	PIT. High/low	INH/ACT Mixing amount	ON -50%	ON, INH ±0~100%	ON/OFF at "HOLD" "1"; OFF "2"; ON
R-OF RUDDER OFFSET	RUD. ON/OFF switch	INH/ACT Offset amount ON/OFF Switch	INH 0%	INH, ON/OFF -100~+100%	IDLE-UP/CH5 switch
R-DL RUDDER OFFSET DELAY	Delay amount		0%	0~100%	
INVR INVERTED FLIGHT	Cross rate	INH/ACT Rate	INH 0%	INH, Inverted mode -100~+100%	
IV-H INVERTED FLIGHT HIGH PITCH	PIT.		100%	30~100%	
IV-L INVERTED FLIGHT LOW PITCH	PIT.		100%	30~100%	
PARA PARAMETER	(See the following functions; "RSET"~"MOD" function)				
RSET DATA RESET	All setting data in the active model memory		-	In the active model memory	
ATL ATL TRIM ON/OFF	THR. trim		ON	ON, OFF	
COMB COMBINATION SWITCH	AIL, D/R switch		MODE "1"	MODE "1"~"3"	Related func. → "D/R" func.
MXSW PROGRAMMABLE MIXING SWITCH (MIXING TYPES)	Each programmable mixing switch		MODE "12"	MODE "12", "1", "-2" "_,_,"	
MOD MODULATION	PCM/PPM		MODE "C" (PCM)	"C"; PCM "F"; PPM	
COPY DATA COPY	Each model memory		-	Model memory 1~4	
TRIM TRIM MEMORY	All stick CH trims		-	CH1~4	Except the ATL trim for THR.
SEL MODEL SELECT	Each model memory		-	Model memory 1~4	
STCK STICK MODE SELECT	(Usually this function is not used.)				Their functions are effective in all model memories.
TREV THROTTLE FUNCTION REVERSE	THR.		Normal side ("N")	"N"; Normal "R"; Reverse	

● SUMMARY OF PROGRAMMES

Mixing type "GLID"

FUNCTION	SETTING POINT	INITIAL VALUE	SETTING RANGE	REMARK	
ATV ADJUSTABLE TRAVEL VOLUME	Each CH Left/right (up/down)	100%	30~120%		
D/R DUAL RATE	AIL. ELE. RUD. Each direction of the D/R switch	100%	30~120%	Related func. → "COMB" func.	
EXP EXPONENTIAL	AIL. ELE. THR. RUD. Each direction of the D/R switch	0%	-100~+100%	No D/R switch for the THR.	
REV REVERSE	Each CH	Normal side "N"	"N"; Normal "R"; Reverse		
F/S FAIL SAFE	Each CH	INH/ACT F/S position	OFF (HOLD) 50%	OFF, F/S 0~100%	
PMX1 PROGRAMMABLE MIXING 1	Between any two channels Left/right (up/ down)	INH/ACT CH selection Mixing amount	INH (Master CH) (Slave CH) CH1 CH2 +50%	INH, ON/OFF CH1~7 ±0~100%	
PMX2 PROGRAMMABLE MIXING 2	(The same as the above.)				
STAT START MIXING	ELE. FLP. AIL.	INH/ACT Mixing amount	INH 0%	INH, ON/OFF -100~+100%	
ABRK AIR BRAKE MIXING	FLP. ELE. AIL.	INH/ACT Position	INH 0%	INH, ON/OFF -100~+100%	(Mixing mode) "OF"; offset "On"; linear
1 → 4 AIL. → RUD. MIXING	AIL. Left/right	INH/ACT Mixing amount	INH +50%	INH, ON ±0~100%	(Mode) "1"; always "ON" "2"; RUD D/R SW
DIFF AILERON DIFFERENTIAL	AIL. (CH7, 1) Left/right	INH/ACT Mixing amount	INH +100%	INH, ON ±0~100%	DIFF and FLAP- ERON cannot be on simultaneously. The function turned on last has priority.
FLPR FLAPERON	AIL. (CH6, 1) Left/right FLP. (CH6, 1)	INH/ACT Mixing amount	INH (AIL. R) +100% (CH1) (AIL. L) +100% (CH6) (FLP.) +100% -100%	INH, ON ±0~100%	
VTAL V-TAIL MIXING	ELE. (2, 4CH) RUD. (2, 4CH)	INH/ACT Mixing amount	INH (CH2) (CH4) (ELE.) +100% +100% (RUD.) +100% -100%	INH, ON ±0~100%	
FLTR FLAP TRIM	FLAP TRIM	INH/ACT Mixing amount	INH 30%	INH, ON 0~100%	
STRM SUB TRIM	Each CH		0%	-100~+100%	
PARA PARAMETER	(See the following functions; "RSET"~"MOD" function)				
RSET DATA RESET	All setting data in the active model memory	-		In the active model memory	
ATL ATL TRIM ON/OFF	THR. trim		ON	ON, OFF	
COMB COMBINATION SWITCH	AIL. D/R switch		MODE "1"	MODE "1"~"3"	Related func. → "D/R" func.
MXSW PROGRAMMABLE MIXING SWITCH	Each programmable mixing switch		MODE "12"	MODE "12", "1-", "-2" "-_";	
(MIXING TYPES)	"ACRO", "GLID", "HLI1", "HLI2"		"ACRO"	"ACRO", "GLID", "HLI1", "HLI2"	
MOD MODULATION	PCM/PPM		MODE "C" (PCM)	"C"; PCM "F"; PPM	
COPY DATA COPY	Each model memory		-	Model memory 1~4	
TRIM TRIM MEMORY	All stick CH trims		-	CH1~4	Except the ATL trim for THR.
SEL MODEL SELECT	Each model memory		-	Model memory 1~4	
STCK STICK MODE SELECT	(Usually this function is not used.)				Their functions are effective in all model memories.
TREV THROTTLE FUNCTION REVERSE	THR.		Normal side ("N")	"N"; Normal "R"; Reverse	

● FP-T7UAPS DATA SHEET (MIXING TYPE "ACRO")

MODEL No.	MODULATION	PCM-PPM			ATL trim		ON-OFF					
		1 AIL	2 ELE	3 THR	4 RUD	5 GER	6 FLP	7 AUX				
ATV ADJUSTABLE TRAVEL VOLUME	R/U									%		
	L/D											
D/R DUAL RATE	U									%	COMBINATION SWITCH	MODE 1 MODE 2 MODE 3
	D											
EXP EXPONENTIAL	U									%		
	D											
REV REVERSE		NOR.	NOR.	NOR.	NOR.	NOR.	NOR.	NOR.		%		
		REV.	REV.	REV.	REV.	REV.	REV.	REV.				
F/S FAIL SAFE		HOLD	HOLD	HOLD	HOLD	HOLD	HOLD	HOLD		%		
		F/S	F/S	F/S	F/S	F/S	F/S	F/S				
	POS.											
STRM SUB TRIM										%		
FLTR FLAP TRIM										%	Trim operation	INH ON

	INH/ACT	RATE				MODE	
PMX1 PROGRAMMABLE MIXING 1	INH	(CH)	R/U	%	MXSW PROGRAM- MABLE MIXING SWITCH	MODE "12"	
	ON/OFF	→	L/D	%		MODE "1"	
PMX2 PROGRAMMABLE MIXING 2	INH	(CH)	R/U	%		MODE "2"	
	ON/OFF	→	L/D	%		MODE " "	
2 → 6 ELEVATOR → FLAP MIXING	INH		U	%			
	ON/OFF		D	%			
ABRK AIR BRAKE MIXING	INH	(AIL)	(ELE)	(FLP)	LINEAR MIXING "On"		
	ON/OFF	%	%	%	OFFSET MIXING "OF"		
1 → 4 AILERON → RUDDER MIXING	INH		R	%	Always ON "1"		
	ON/OFF		L	%	RUD D/R switch "2"		
SNP SNAP-ROLL	INH	(AIL)	(ELE)	(RUD)	SAFETY mode released "F"		
		(R/U)	%	%			
		(R/D)	%	%			
	ON/OFF	(L/U)	%	%	SAFETY mode set "5L/5F"		
	(L/D)	%	%				
DIFF AILERON DIFFERENTIAL	INH	(CH1)	(CH7)	%			
	ON	(R)	%	%			
FLPR FLAPERON	INH	(CH1)	(CH6)	%			
		(AIL-R)	%	%			
	ON	(AIL-L)	%	%			
	(FLP)	%	%				
ELVN ELEVON	INH	(CH1)	(CH2)	%			
		(AIL-R)	%	%			
	ON	(AIL-L)	%	%			
	(ELE)	%	%				

FP-T7UAPS DATA SHEET (MIXING TYPE "HLI1/2")

MODEL No.	MODULATION	PCM-PPM			ATL trim		ON-OFF			%	
		1 AIL	2 ELE	3 THR	4 RUD	5 GYR	6 PIT	7 AUX			
ATV ADJUSTABLE TRAVEL VOLUME	R/U L/D										
D/R DUAL RATE	U D										COMB COMBINA- TION SWITCH
EXP EXPONENTIAL	U D										
REV REVERSE		NOR. REV.	NOR. REV.	NOR. REV.	NOR. REV.	NOR. REV.	NOR. REV.	NOR. REV.			
F/S FAIL SAFE		HOLD F/S	HOLD F/S	HOLD F/S	HOLD F/S	HOLD F/S	HOLD F/S	HOLD F/S			
	POS.										

	INH/ACT	Rate					MODE
		(CH)	R/U	%			
PMX PROGRAMMABLE MIXING	INH ON/OFF	→	L/D	%			
T-NR NORMAL THROTTLE CURVE		(1) %	(2) %	(3) %	(4) %	(5) %	
T-I1 IDLE-UP 1 THROTTLE CURVE	INH ON/OFF	(1) %	(2) %	(3) %	(4) %	(5) %	
T-I2 IDLE-UP 2 THROTTLE CURVE	INH ON/OFF	(1) %	(2) %	(3) %	(4) %	(5) %	
HOLD THROTTLE HOLD	INH ON/OFF						%
P-NR NORMAL PITCH CURVE		(1) %	(2) %	(3) %	(4) %	(5) %	
P-I1 IDLE-UP 1 PITCH CURVE		(1) %	(2) %	(3) %	(4) %	(5) %	
P-I2 IDLE-UP 2 PITCH CURVE		(1) %	(2) %	(3) %	(4) %	(5) %	
P-HD THROTTLE HOLD PITCH CURVE		(1) %	(2) %	(3) %	(4) %	(5) %	
HV-T HOVERING THROTTLE	INH ON						
HV-P HOVERING PITCH	INH ON						
ID-H IDLE-UP HIGH PITCH							%
NR-L NORMAL LOW PITCH							%
REVO REVOLUTION MIXING	INH ON	Main rotor	"-" "+"	H L	%		ON/OFF at THR- OTTLE HOLD
R-OFF RUDDER OFFSET	INH ON/OFF	Offset			%		ON/OFF switch IDLE-UP "1" CH5 "2"
R-DL RUDDER OFFSET DELAY		Delay			%		
INVR INVERTED FLIGHT	INH INVERTED	Cross rate			%		
IV-H INVERTED FLIGHT HIGH PITCH							%
IV-L INVERTED FLIGHT LOW PITCH							%

● FP-T7UAPS DATA SHEET (MIXING TYPE "GLID")

MODEL No.	MODULATION	PCM-PPM			ATL trim		ON-OFF						
		1 AIL	2 ELE	3	4 RUD	5 GER	6 FLP	7 AUX					
ATV ADJUSTABLE TRAVEL VOLUME	R/U L/D										%		
D/R DUAL RATE	U D										%	COMBINATION SWITCH	MODE 1
EXP EXPONENTIAL	U D										%		MODE 2
REV REVERSE		NOR. REV.	NOR. REV.	NOR. REV.	NOR. REV.	NOR. REV.	NOR. REV.	NOR. REV.			%		MODE 3
F/S FAIL SAFE		HOLD F/S	HOLD F/S	HOLD F/S	HOLD F/S	HOLD F/S	HOLD F/S	HOLD F/S			%		
STRM SUB TRIM	POS.										%		
FLTR FLAP TRIM											%	Trim operation	INH ON

	INH/ACT	RATE			MXSW PROGRAM- MIXING SWITCH	MODE	
		(CH)	R/U	%		MODE "12"	MODE "1-"
PMX1 PROGRAMMABLE MIXING 1	INH ON/OFF	(CH) →	R/U L/D	% %	PROGRAM- MIXING SWITCH	MODE "12"	MODE "1-"
PMX2 PROGRAMMABLE MIXING 2	INH ON/OFF	(CH) →	R/U L/D	% %		MODE "-2"	MODE "-"
STAT START MIXING	INH ON/OFF	(AIL) % (ELE) % (FLP) %					
ABRK AIR BRAKE MIXING	INH ON/OFF	(AIL) % (ELE) % (FLP) %				LINEAR MIXING "On"	OFFSET MIXING "OF"
1 → 4 AILERON → RUDDER MIXING	INH ON/OFF		R L	% %		Always ON "1"	RUDD. D/R switch "2"
DIFF AILERON DIFFERENTIAL	INH ON	(R) % (L) %	(CH1) % (CH7) %				
FLPR FLAPERON	INH ON	(AIL-R) % (AIL-L) % (FLP) %	(CH1) % (CH6) %				
VTAL V-TAIL MIXING	INH ON	(ELE) % (RUD) %	(CH2) % (CH4) %				

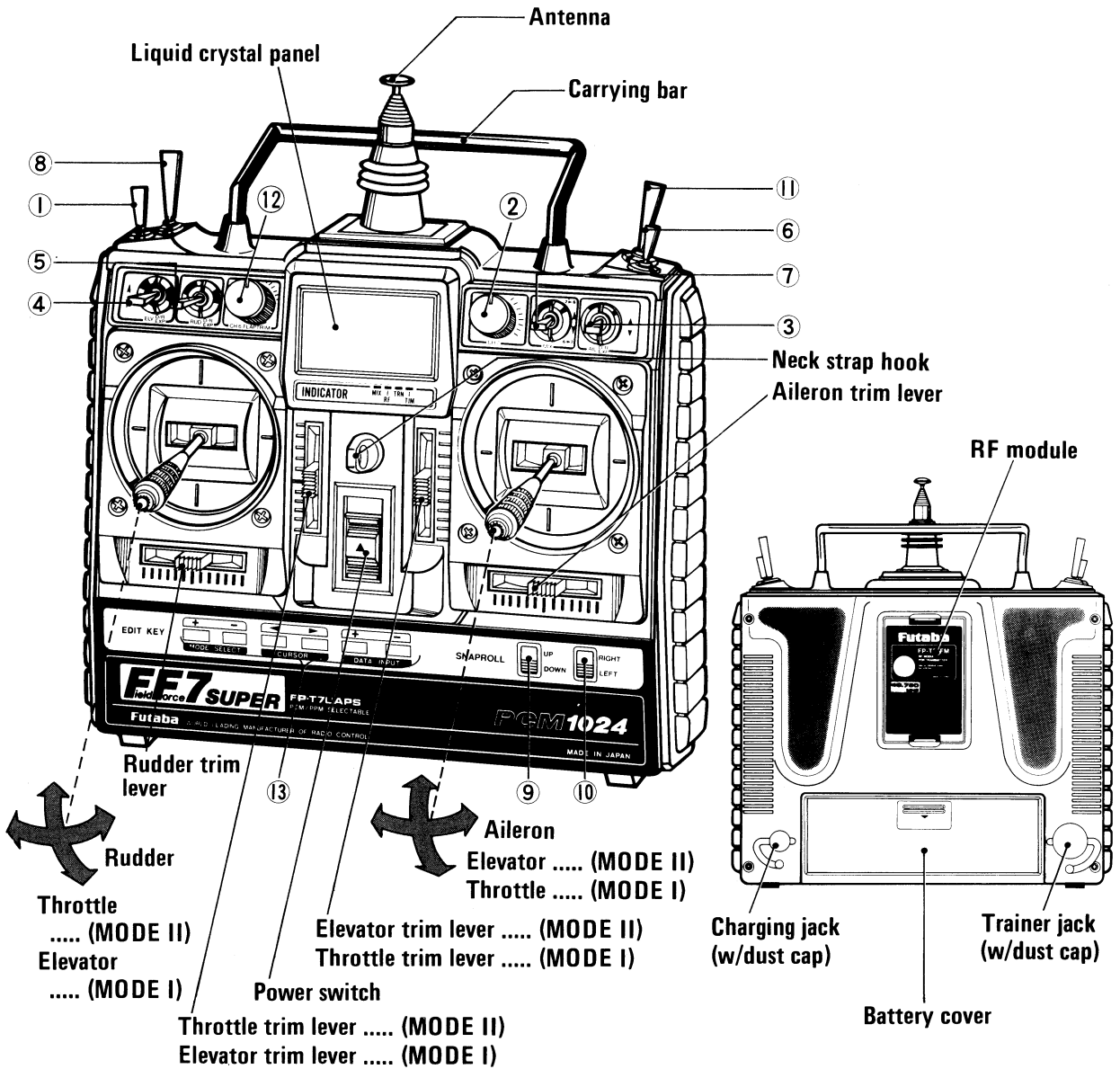

No.	Mixing type "ACRO"	Mixing type "GLID"	Mixing type "HLI 1/2"
①	Landing gear switch (CH5) ... (MODE II) Programmable mixing switch ... (MODE I)	Landing gear switch (CH5) ... (MODE II) Programmable mixing switch ... (MODE I)	Throttle hold switch ... (MODE II) CH5/inverted switch ... (MODE I)
②	AUX knob (CH7)	AUX knob (CH7)	Hovering throttle knob
③	Aileron D/R switch	Aileron D/R switch	Aileron D/R switch
④	Elevator D/R switch	Elevator D/R switch	Elevator D/R switch/ programmable mixing switch
⑤	Rudder D/R switch	Rudder D/R switch	Rudder D/R/CH7 switch
⑥	Programmable mixing switch ... (MODE II) Landing gear switch (CH5) ... (MODE I)	Programmable mixing switch ... (MODE II) Landing gear switch (CH5) ... (MODE I)	CH5/inverted switch ... (MODE II) Throttle hold switch ... (MODE I)
⑦	2 → 6/air brake mixing switch	Start/air brake mixing switch	Idle-up 1/2 switch
⑧	Snap roll switch ... (MODE II) Trainer switch ... (MODE I)	Trainer switch ... (MODE I)	Trainer switch ... (MODE I)
⑨	Snap roll direction switch	—	—
⑩	Snap roll direction switch	—	—
⑪	Trainer switch ... (MODE II) Snap roll switch ... (MODE I)	Trainer switch ... (MODE II)	Trainer switch ... (MODE II)
⑫	Flap knob/flap trim lever (CH6)	Flap knob/flap trim lever (CH6)	CH6/hovering pitch knob
⑬	Edit keys	Edit keys	Edit keys

● SERVO EXPLODED VIEW

FP-S148

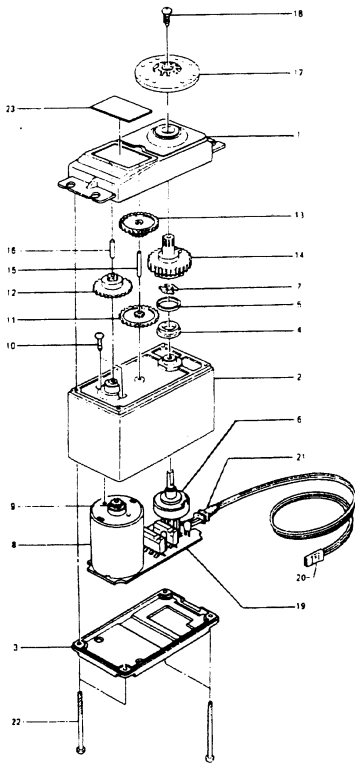

No.	Part Name	Part No.
1	Upper case	S06015
2	Middle case	S06005
3	Bottom case	S06006
4	Metal bearing inner	S04137
5	Metal bearing outer	S04136
6	TR133-15	I39668
7	VR drive plate	S02753
8	Motor	S91239
9	Motor pinion	S02461
10	Motor mounting screw	J50002
11	1st gear	S02490
12	2nd gear	S02491
13	3rd gear	S03266
14	Final gear	S02752
15	Intermediate shaft	S02495
16	2nd shaft	S02494
17	Splined horn D	S01239
18	Horn mounting screw	J55178
19	AMP	AS1157
20	S148 ... 3PB-SWRB300C	AT2453
21	Grommet	S90045
22	Case mounting screw	S50360
23	Nameplate	S60099

FP-S3001

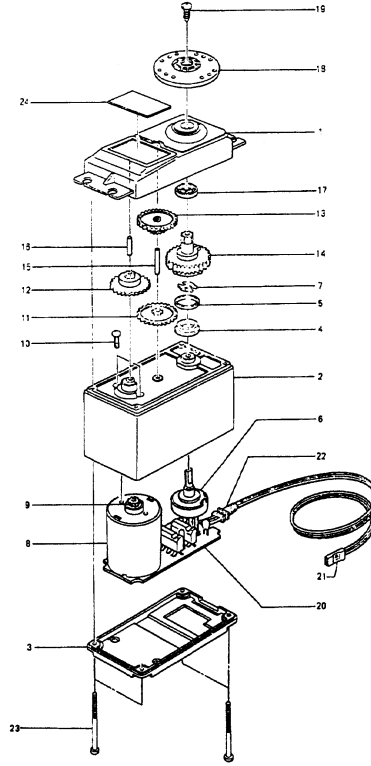

No.	Part Name	Part No.
1	Upper case	S06100
2	Middle case	S06005
3	Bottom case	S06006
4	Metal bearing inner	S04137
5	Metal bearing outer	S04136
6	TR133-15	I39668
7	VR drive plate	S02753
8	Motor	S91239
9	Motor pinion	S02461
10	Motor mounting screw	J50002
11	1st gear	S02490
12	2nd gear	S02491
13	3rd gear	S03266
14	Final gear	S02752
15	Intermediate shaft	S02495
16	2nd shaft	S02494
17	Bearing L-1060	S04130
18	Splined horn D	S01239
19	Horn mounting screw	J55178
20	AMP	AS1341
21	3PB-SWRB300C	AT2453
22	Grommet	S90045
23	Case mounting screw	S50085
24	Nameplate	S60189

FP-S9101

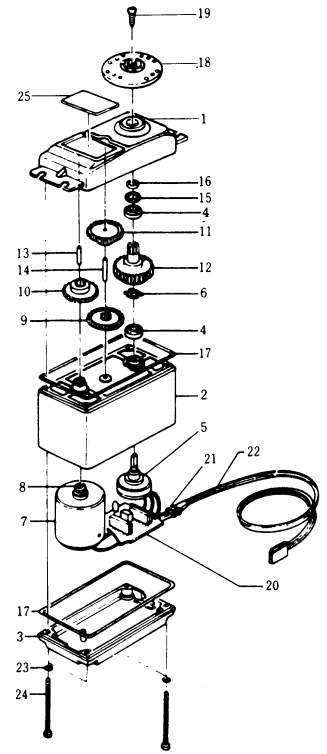

No.	Part name	Part No.
1	Upper case	FCS-9101
2	Middle case	FCS-9101
3	Bottom case	FCS-9101
4	Ball bearing	S04130
5	Potentiometer	I39995
6	VR drive plate	S02753
7	Coreless motor	S91265
8	Motor pinion	S02497
9	1st gear	FGS-9101
10	2nd gear	FGS-9101
11	3rd gear	FGS-9101
12	Final gear	FGS-9101
13	2nd shaft	S02481
14	Intermediate shaft	S02480
15	Spacer washer	S02486
16	Seal ring	S90415
17	O-ring	S90417
18	Servo horn D	FSH-6W
19	Horn mounting screw	FSH-4I
20	Printed wiring board	AS1333
21	Lead wire packing	S90045
22	3PB-WRB-300 B	FPC-8MB
23	Screw O-ring	S90410
24	Case mounting screw	J50085
25	S9101 Nameplate	S60093