

# FX-40

14 CHANNEL RADIO CONTROL SYSTEM  
PCMG3/PCM1024/FM selectable

## INSTRUCTION MANUAL



# TABLE OF CONTENTS

<b>INTRODUCTION.....</b>	<b>4</b>	<b>•In case of using PCM1024, PPM receivers... 27</b>	
<b>•Support and Service .....</b>	<b>4</b>	<b>•Registration of the user's name .....</b>	<b>27</b>
<b>•Application, Export, and Modification .....</b>	<b>5</b>	<b>•Home screen .....</b>	<b>28</b>
<b>•Definitions of Symbols.....</b>	<b>6</b>	<b>•Music play back .....</b>	<b>29</b>
<b>•Safety Precautions (do not operate without reading) .....</b>	<b>6</b>		
<hr/>			
<b>BEFORE USE .....</b>	<b>9</b>	<b>FUNCTIONS OF SYSTEM MENU .....</b>	<b>30</b>
<b>•Features of FX-40 .....</b>	<b>9</b>	Trainer .....	31
<b>•Contents and technical specifications .....</b>	<b>11</b>	Display .....	33
<b>•Accessories.....</b>	<b>12</b>	Date & Time.....	34
<b>•Transmitter controls.....</b>	<b>13</b>	User Name.....	35
Cautions on handling antenna .....	13	Switch.....	36
LED monitor .....	14	HW Setting.....	37
Switch reallocation (SA-SH) .....	14	Information .....	39
Volume (LD, CD, RD) .....	15		
Slide Lever (L1-L3) .....	15		
Digital trim (T1-T8).....	16		
Touch panel/Rotary key/Direct key .....	16		
Stick Adjustment.....	17		
CF card CFDP32M .....	18		
Connector/Plug.....	19		
USB port (*This port is for factory use only.).....	19		
Attachment and detachment of the battery.....	20		
RF module FX-FM.....	21		
Toolbox .....	21		
<b>•Receiver nomenclature.....</b>	<b>22</b>		
<b>•Safety precautions when installing receiver and servos .....</b>	<b>23</b>		
<hr/>			
<b>BASIC OPERATION .....</b>	<b>24</b>	<b>MODEL BASIC SETTING PROCEDURE ...</b>	<b>40</b>
<b>•Battery Charging.....</b>	<b>24</b>	<b>•Airplane/glider basic setting procedure.....</b>	<b>40</b>
How to charge the Lithium Ion Battery .....	24	<b>•Helicopter basic setting procedure.....</b>	<b>42</b>
How to charge the Ni-Cd Battery.....	24	<b>•Receiver and servos connection.....</b>	<b>46</b>
<b>•How to turn On/OFF the transmitter .....</b>	<b>25</b>	<b>•Servo connection by model type.....</b>	<b>47</b>
When turning on.....	25		
When turning off.....	25		
How to reset .....	26		
<b>•How to change the frequency/How to set the receiver's ID.....</b>	<b>26</b>		
<hr/>			
		<b>FUNCTIONS OF LINKAGE MENU .....</b>	<b>51</b>
		<b>(Common Functions)</b>	
		Linkage Menu functions table.....	51
		Servo Monitor .....	52
		Model Select .....	53
		Model Type .....	54
		Picture .....	56
		Sound .....	57
		Frequency.....	59
		Function .....	60
		Sub-Trim .....	62
		Servo Reverse .....	63
		Fail Safe .....	64
		End Point (ATV) .....	65
		Throttle Cut (Airplane/helicopter only) .....	66
		Idle Down (Airplane/helicopter only).....	67
		Swash (Helicopter only).....	68
		Timer .....	70
		Dial Monitor.....	71
		Data Reset .....	72

---

## **FUNCTIONS OF MODEL MENU**

<b>•Common Functions (Model Menu).....</b>	<b>73</b>
Servo Monitor .....	52
Condition Select .....	74
Condition Hold.....	75
AFR (D/R).....	76
Program Mix .....	78
Fuel Mixture.....	80
<b>•Airplane/Glider/EP Glider Functions.....</b>	<b>81</b>
Model Menu functions list .....	81
AIL Differential.....	83
Flap Setting .....	84
AIL to Camber FLP.....	85
AIL to Brake FLP.....	86
AIL to RUD.....	87
Airbrake to ELE .....	88
RUD to AIL.....	89
Camber Mix .....	90
ELE to Camber.....	92
Camber FLP to ELE.....	93
Butterfly .....	96
Trim Mix 1/2 .....	96
Airbrake .....	98
Gyro .....	100
V-tail.....	101
Ailevator.....	102
Winglet.....	103
Motor.....	104
RUD to ELE.....	105
Fuel Mixture.....	80
Snap Roll.....	106
Multi Engine .....	107

## **•Helicopter Functions ..... 108**

Model Menu functions list .....	108
PIT Curve .....	109
THR Curve .....	112
Acceleration .....	114
Throttle Hold.....	115
Swash Mix.....	116
Throttle Mix .....	117
PIT -> Needle.....	118
PIT -> RUD.....	119
Fuel Mixture.....	80
Gyro .....	120
Governor .....	121

## **•Common Operations used in function setup screen..... 122**

## INTRODUCTION

Thank you for purchasing the Futaba® FX-40 series digital proportional R/C system. In order for you to make the best use of your system and to fly safely, please read this manual carefully. If you have any difficulties while using your system, please consult the manual, our online Frequently Asked Questions (on the web pages referenced below), your hobby dealer, or the Futaba Service Center.

Due to unforeseen changes in production procedures, the information contained in this manual is subject to change without notice.

Support and Service: It is recommended to have your Futaba equipment serviced annually during your hobby's "off season" to ensure safe operation.

## IN NORTH AMERICA

Please feel free to contact the Futaba Service Center for assistance in operation, use and programming. Please be sure to regularly visit the FX-40 Frequently Asked Questions web site at <http://www.futaba-rc.com/faq/faq/index.html>. This page includes extensive programming, use, set up and safety information on the FX-40 radio system and is updated regularly. Any technical updates and US manual corrections will be available on this web page. If you do not find the answers to your questions there, please see the end of our F.A.Q. area for information on contacting us via email for the most rapid and convenient response.

Don't have Internet access? Internet access is available at no charge at most public libraries, schools, and other public resources. We find internet support to be a fabulous reference for many modelers as items can be printed and saved for future reference, and can be accessed at any hour of the day, night, weekend or holiday. If you do not wish to access the internet for information, however, don't worry. Our support teams are available Monday through Friday 8-5 Central time to assist you.

### **FOR SERVICE ONLY**

Futaba Service Center  
3002 N. Apollo Drive, Suite 1  
Champaign, IL 61822  
Phone: 217-398-0007  
[www.hobbyservices.com](http://www.hobbyservices.com)

### **FOR SUPPORT**

#### **(PROGRAMMING AND USER QUESTIONS)**

Please start here for answers to most questions:

[www.futaba-rc.com](http://www.futaba-rc.com)  
FACSIMILE: 217-398-7721  
PHONE: 217-398-8970 option 2

## OUTSIDE NORTH AMERICA

Please contact your Futaba importer in your region of the world to assist you with any questions, problems or service needs. Please recognize that all information in this manual, and all support availability, is based upon the systems sold in North America only. Products purchased elsewhere may vary. Always contact your region's support center for assistance.

## Application, Export, and Modification

1. This product is suitable for model airplane, surface or 50 MHz (license required) use, if on the correct frequency. It is not intended for use in any application other than the control of models for hobby and recreational purposes. The product is subject to regulations of the FCC and is restricted under United States law to such purposes.
2. Exportation precautions:
  - (a) When this product is exported from the country of manufacture, its use is to be approved by the laws governing the country of destination which govern devices that emit radio frequencies. If this product is then re-exported to other countries, it may be subject to restrictions on such export. Prior approval of the appropriate government authorities may be required. If you have purchased this product from an exporter outside your own country and not the authorized Futaba distributor in your country, please contact the seller immediately to determine if such export regulations have been met.
  - (b) Use of this product with other than models may be restricted by Export and Trade Control Regulations, and an application for export approval must be submitted. In the US, use of 72MHz (aircraft only), 75MHz (ground models only) and 27MHz (both) frequency bands are strictly regulated by the FCC. This equipment must not be utilized to operate equipment other than radio controlled models. Similarly, other frequencies (except 50MHz, for HAM operators) must not be used to operate models.
3. Modification, adjustment, and replacement of parts: Futaba is not responsible for unauthorized modification, adjustment, and replacement of parts on this product. Any such changes may void the warranty.

The Following Statement Applies to the Receiver (for U.S.A.)

This device complies with part 15 of the FCC rules. Operation is subject to the following two conditions:

- (1) This device may not cause harmful interference.
- (2) This device must accept any interference received, including interference that may cause undesirable operation.



The RBRC™ SEAL on the nickel-cadmium battery contained in Futaba products indicates that Futaba Corporation of America is voluntarily participating in an industry-wide program to collect and recycle these batteries at the end of their useful lives, when taken out of service within the United States. The RBRC program provides a convenient alternative to placing used nickel-cadmium batteries into the trash or municipal waste system, which is illegal in most areas.

You may contact your local recycling center for information on where to return the spent battery. Please call 1-800-8-BATTERY for information on battery recycling in your area. Futaba Corporation of America's involvement in this program is part of its' commitment to protecting our environment and conserving natural resources.

**NOTE:** Our instruction manuals encourage our customers to return spent batteries to a local recycling center in order to keep a healthy environment. RBRC is a trademark of the Rechargeable Battery Recycling Corporation.

## Definitions of Symbols

Pay special attention to safety where indicated by the following symbols.

 **DANGER** – Procedures which may lead to dangerous conditions and cause death/serious injury if not carried out properly.

 **WARNING** – Procedures which may lead to a dangerous condition or cause death or serious injury to the user if not carried out properly, or procedures where the probability of superficial injury or physical damage is high.

 **CAUTION** – Procedures where the possibility of serious injury to the user is small, but there is a danger of injury, or physical damage, if not carried out properly.

 = **Prohibited**

 = **Mandatory**

**Warning:** Always keep electrical components away from small children.

### FLYING SAFETY

To ensure the safety of yourself and others, please observe the following precautions:

 **Have regular maintenance performed.** Although your FX-40 protects the model memories with non-volatile EEPROM memory (which does not require periodic replacement) and not a battery, it still should have regular checkups. We recommend sending your system to the Futaba Service Center annually during your non-flying season for a complete checkup and service.

 **Use the *Fail-Safe* safety feature to set the throttle to *low-idle* in case of signal loss or RX battery failure.** Engine power will be automatically reduced to help limit personal or property damage. Refer to the **Failsafe Setting Procedure** listed in the index.

### Receiver Ni-Cd Battery

 **Charge the batteries!** (See **Charging the batteries** listed in the index for details.) Always recharge the receiver batteries for at least 8 hours before each flying session. A low battery will soon die, causing loss of control and a crash. When you begin your flying session, reset your timer, and during the session pay attention to the duration of usage.

**CAUTION:** The **initial** charge on **new** NiCd receiver batteries should be done for 15 hours **using the slow-charger that came with the radio system**. This will “condition” the batteries so that the next charge may be done using the fast-charger of your choice. If the initial charge is done with a fast-charger the batteries may not reach their full capacity and you may be flying with batteries that are only partially charged.

### Where to Fly

We recommend that you fly at a recognized model airplane flying field. You can find model clubs and fields by asking your nearest hobby dealer, or in the US by contacting the Academy of Model Aeronautics. You can also contact the national Academy of Model Aeronautics (AMA), which has more than 2,500 chartered clubs across the country. Through any one of them, instructor training programs and insured newcomer training are available. Contact the AMA at the address or toll-free phone number below.

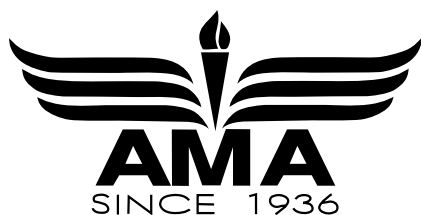

#### Academy of Model Aeronautics

5151 East Memorial Drive  
Muncie, IN 47302-9252  
Tel. (800) 435-9262  
Fax (765) 741-0057

or via the Internet at <http://www.modelaircraft.org>

## Lithium-ION Battery Safety and Handling instructions

**IMPORTANT!** The Lithium-Ion (Li-Ion) batteries included in the FX-40 transmitter are not to be confused with Lithium-Polymer (LiPo) batteries, or any other type of rechargeable battery (including NiCd's and NiMH's). Li-Ion batteries require special charging criteria different than other rechargeable batteries. Use only the **Futaba** lithium ion transmitter charger included with this set for, or other chargers approved by Futaba to charge the Li-Ion batteries in the FX-40 transmitter.

It is important to understand the operating characteristics of lithium-ion (Li-Ion) batteries. Always read the specifications printed on the label of your Li-Ion battery and charger prior to use. Failure to follow the proceeding precautions can quickly result in severe, permanent damage to the batteries and its surroundings and possibly result in a **FIRE!**

### IMPORTANT PRECAUTIONS

- ⊘ Do not attempt to disassemble Li-Ion packs or cells.
- ⊘ Do not allow Li-Ion cells to come in contact with moisture or water at any time.
- ⊘ Always provide adequate ventilation around Li-Ion batteries during charge, discharge, while in use, and during storage.
- ⊘ Do not leave a Li-Ion battery unattended at any time while being charged or discharged.
- ⊘ Do not attempt to charge Li-Ion batteries with a charger that is NOT designed for Li-Ion batteries, as permanent damage to the battery and charger could result.
- ⊘ Always charge Li-Ion batteries in a fireproof location. Do not charge or discharge Li-Ion batteries on carpet, a cluttered workbench, near paper, plastic, vinyl, leather or wood, or inside an R/C model or full sized automobile! Monitor the charge area with a smoke or fire alarm, and have a lithium-approved "ABC type" fire extinguisher available at all times.
- ⊘ Do not charge Li-Ion batteries at currents greater than the "1C" rating of the battery ("C" equals the rated capacity of the battery).
- ⊘ Do not allow Li-Ion cells to overheat at any time! Cells which reach greater than 140 degrees Fahrenheit (60°C) should be placed in a fireproof location.
- ⊘ It is normal for the batteries to become warm during charging, but if the charger or battery becomes excessively hot disconnect the battery from the charger **immediately!!** Always inspect a battery which has previously overheated for potential damage, and do not re-use if you suspect it has been damaged in any way.
- ⊘ Do not use a Li-Ion battery if you suspect physical damage has occurred to the pack. Carefully inspect the battery for even the smallest of dents, cracks, splits, punctures or damage to the wiring and connectors. DO NOT allow the battery's internal electrolyte to get into eyes or on skin—wash affected areas immediately if they come in contact with the electrolyte. If in doubt, place the battery in a fire-proof location for at least 30 minutes.
- ⊘ Do not store batteries near an open flame or heater.
- ⊘ Do not discharge Li-Ion batteries at currents which exceed the discharge current rating of the battery.
- ⊘ Always store Li-Ion cells/packs in a secure location away from children.

### Compact Flash (CF) Card Handling Instructions

Follow these precautions when handling the CF card included in your FX-40 transmitter.

- ⊘ Never remove the CF card or turn off power while entering data.
- ⊘ Never store the CF card where it may be subject to strong static electricity or magnetic fields.
- ⊘ Do not expose the CF card to direct sunlight, excessive humidity or corrosive environments.
- ⊘ Do not expose the CF card to dirt, moisture, water or fluids of any kind.
- ⚠ Always hold the CF card by the edges during installation and removal.
- ⚠ Be certain to insert the CF card in the correct direction.

## AT THE FLYING FIELD

- ❗ **Always pay particular attention to the flying fields' rules**, as well as the presence and location of spectators, the wind direction, and any obstacles on the field. Be very careful flying in areas near power lines, tall buildings, or communication facilities as there may be radio interference in their vicinity. If you must fly away from a club field, be sure there are no other modelers flying within a three-to-five-mile range, or you may lose control of your aircraft or cause someone else to lose control.
- ❗ **Before flying, be sure that the frequency you intend to fly with is not in use**, and secure any frequency control device (pin, tag, etc.) for that frequency before turning on your transmitter. It is never possible to fly two or more models on the same frequency at the same time. Even though there are different types of modulation (AM, FM, PCM), only one model may be flown on a single frequency at any one time.
- ❗ **Stop flying long before your batteries become low on charge**. Do not rely on your radio's low-battery warning systems, which are intended only as a precaution, to tell you when to recharge. **Always check your transmitter and receiver batteries prior to each flight**.
- ❗ To prevent possible damage to your radio gear, turn the power switches on and off in the proper sequence:
  1. Set the throttle stick to the idle position, or otherwise disarm your motor/engine.
  2. Fully extend the transmitter antenna.
  3. Turn on the transmitter power and allow your transmitter to reach its home screen.
  4. Confirm the proper model memory has been selected.
  5. Turn on your receiver power.
  6. Test all controls. If a servo operates abnormally, don't attempt to fly until you determine the cause of the problem. (For PCM systems only: Test to ensure that the Failsafe settings are correct by waiting at least 2 minutes after adjusting then, turning the transmitter off and confirming the proper surface/throttle movements. Turn the transmitter back on.)
  7. Start your engine.
  8. Complete a full range check.
  9. After flying, bring your throttle stick to idle position, engage any kill switches or otherwise disarm your motor/engine.
  10. Turn off receiver power.
  11. Turn off transmitter power.

If you do not turn on your system in this order, you may damage your servos or control surfaces, flood your engine, or in the case of electric-powered or gasoline-powered models, the engine may unexpectedly turn on and cause a severe injury.

- ❗ **While you are getting ready to fly, if you place your transmitter on the ground, be sure that the wind won't tip it over**. If it is knocked over, the throttle stick may be accidentally moved, causing the engine to speed up. Also, damage to your transmitter may occur.
- ❗ **Before taxiing, be sure to extend the transmitter antenna to its' full length**. A collapsed antenna will reduce your flying range and cause a loss of control. It is a good idea to avoid pointing the transmitter antenna directly at the model, since the signal is weakest in that direction.
- ⊘ **Don't fly in the rain!** Water or moisture may enter the transmitter through the antenna or stick openings and cause erratic operation or loss of control. If you must fly in wet weather during a contest, be sure to cover your transmitter with a waterproof barrier. Never fly if lightning is expected.
- ⊘ **Never turn the transmitter off during flight!** Switching the transmitter off and on during flight will very likely cause a crash because of the time required for the transmitter to "reboot" and become fully functional.



---

## **BEFORE USE**

### **FEATURES**

#### **PCMG3 (PCM Generation 3)**

PCMG3 has a 40% faster response than current PCM1024. The resolution is 2048, which is double the current PCM1024. It can operate up to 14 Channels. The multi-level modulation technology has been implemented for the R/C industry to achieve the highest performance available today.

#### **WindowsCE**

FX-40 utilizes the world famous Microsoft WindowsCE, which offers outstanding dependability and valuable resources.

#### **Color LCD**

FX-40 has a HVGA (640x240 pixels) wide screen full color LCD. It has a backlight and the screen is manufactured of a transfective construction which enables both indoor and outdoor visibility.

#### **Music Play**

FX-40 can playback WMA (Windows Media Audio) files on a CF-Card. You can enjoy music by the internal speaker or stereo headphone from the earphone jack, and you can assign switches to start/stop your music. You can download the WMA files of your own music from your PC.

#### **Voice Recording**

You can record your own voice by internal microphone and then play back commands to be assigned to certain switches. Recording time is 3 seconds maximum and 24 voice files can be stored.

#### **Picture Image Pasting**

You can paste picture image files (168x80 pixels) taken by digital camera to the model screen. Enabling you to download any image you like on your home screen.

#### **Compact Flash**

The model data and music files, voice files, picture image files are stored to Compact flash (CF) card. The memory size is 32 MB. Futaba prepares industrial rating CF cards.

#### **WFSS (Wireless Frequency Setting System)**

The construction of both transmitter (FX-40) and receiver (R5014) are a frequency synthesizer system.

#### **Editing**

The touch panel and rotary encoder editing system will allow you to edit your model in the manner that is easiest and most functional for you.

#### **Functions**

The internal dual processors operate the many FX-40 FEATURE functions and optimize the response time. Most of the mixing functions are operated by curves which give you more precise settings.

---

### **Stick**

Each axis is supported by dual ball bearings. This allows for finer and more precise operation, the new potentiometers also offer longer life.

### **Replaceable switches**

You can replace 8 of the toggle switches on the right and left, with optional switches (two position, three position, and momentary etc.).

### **Li-ion battery**

FX-40 is operated by 7.4V/5,000 mAh Lithium-Ion battery.

### **R5014DPS**

The R5014DPS is a small 14CH synthesized receiver with high sensitivity and selectability.

### **Multi-Prop Decoder (Optional)**

The MPDX-1 multi-prop decoder connects to the receiver output of FX-40 System and expands the signal of one channel to 8 channels.

---

## Contents and Technical Specifications

(Specifications and ratings are subject to change without notice.)

**Your FX-40 (packaged with a 14-channel PCM-G3 receiver) includes the following components:**

- FX-40 Transmitter, including RF module (FX-FM)
- R5014 Receiver
- CFDP32M Data-Pack (CF card)
- LT4F5000 Li-ion battery, LBC-2E5 Charger, FAD-1 AC adapter
- Switch harness/DSC cord
- Tool Box (includes special jig for adjustment)
- Accessory parts (Long lever head/Modification to ratchet system)

(The set contents depend on the type of set.)

### **Transmitter FX-40**

Operating system: 2-stick, 14 channels, PCM-G3, synthesizer system

Transmitting frequency: US only 72 or 50 MHz bands

Modulation: PCM-G3, PCM1024, or FM/PPM switchable.

Power supply: 7.4V LT4F5000 Li-ion battery

Current drain: 1 ampere maximum (RF power on and back light on) 700mA average

### **Receiver R5014DPS**

**(PCM-G3, Synthesizer, Dual conversion)**

Receiving frequency: US only 72 or 50 MHz bands

Intermediate freq.: 10.7 MHz & 450 kHz

Power requirement: 4.8 V Ni-Cd battery

Current drain: 75 mA

Size: 52x37.5x16.5 mm

Weight: 33 g.

Channels: 14

### **Suggested Servos for use with your FX-40**

#### **Servo S9154 (Digital servo)**

Control system: Pulse width control, 1.52 ms neutral

Power requirement: 4.8 V (from receiver)

Output torque: 63.9 oz.-in. (4.6 kg-cm) at 4.8V

Operating speed: 0.14 sec/60 at 4.8V

Size: 1.87 x 1.06 x 0.97 in. (47.5 x 27.0 x 25.3 mm)

Weight: 1.87 oz. (53 g)

#### **Servo S9151 (Digital servo)**

Control system: Pulse width control, 1.52 ms neutral

Power requirement: 4.8 V (from receiver)

Output torque: 131.9 oz.-in. (9.5 kg-cm) at 4.8V

Operating speed: 0.19 sec/60 at 4.8V

Size: 1.57 x 0.79 x 1.44 in. (40.0 x 20.0 x 36.6 mm)

Weight: 1.79 oz. (50 g)

#### **Servo S9250 (Digital servo)**

Control system: Pulse width control, 1.52 ms neutral

Power requirement: 4.8 V (from receiver)

Output torque: 76.4 oz.-in. (5.5 kg-cm) at 4.8V

Operating speed: 0.11 sec/60 at 4.8V

Size: 1.59 x 0.79 x 1.48 in. (40.5 x 20.0 x 37.5 mm)

Weight: 1.90 oz. (54 g)

#### **Servo S9255 (Digital servo)**

Control system: Pulse width control, 1.52 ms neutral

Power requirement: 4.8 V (from receiver)

Output torque: 125.0 oz.-in. (9.0 kg-cm) at 4.8V

Operating speed: 0.16 sec/60 at 4.8V

Size: 1.57 x 0.79 x 1.44 in. (40.0 x 20.0 x 36.6 mm)

Weight: 1.94 oz. (55 g)

---

**The following additional accessories are available from your dealer. Refer to a Futaba catalog for more information:**

- Compact Flash Memory card - CFDP 32M Data-Pack increases your model, music file, voice file, and picture image file storage capability, and allows you to transfer model settings to another FX-40 transmitter.
- LT4F5000 Transmitter battery pack - the (5000mAh) transmitter Li-ion battery pack may be easily exchanged with a fresh one to provide enough capacity for extended flying sessions.
- Trainer cord - the optional training cord may be used to help a beginning pilot learn to fly easily by placing the instructor on a separate transmitter. Note that the FX-40 transmitter may be connected to another FX-40 system, as well as to any other models of Futaba transmitters. The FX-40 transmitter uses the newer "Micro" rectangular type cord plug. Both Micro- to-Micro and Micro-to-round plug style trainer cords are available.
- Y-harnesses, servo extensions, etc - Genuine Futaba extensions and Y-harnesses, including a heavy-duty version with heavier wire, are available to aid in your larger model and other installations.
- Gyros - a variety of genuine Futaba gyros are available for your aircraft or helicopter needs.
- Governor (GV1) - for helicopter use. Automatically adjusts throttle servo position to maintain a constant head speed regardless of blade pitch, load, weather, etc.
- DSC Cord - allows setup and testing without transmitting. With your Transmitter and Receiver off, plug cord into trainer port then, into the receiver Battery/DSC (B/C) slot. All programming and setup may be done in this manner without transmitting.
- Receivers - various models of Futaba receivers may be purchased for use in other models. (Receivers for PCM-G3, PCM1024, or FM/PPM types are available.)

## Transmitter controls

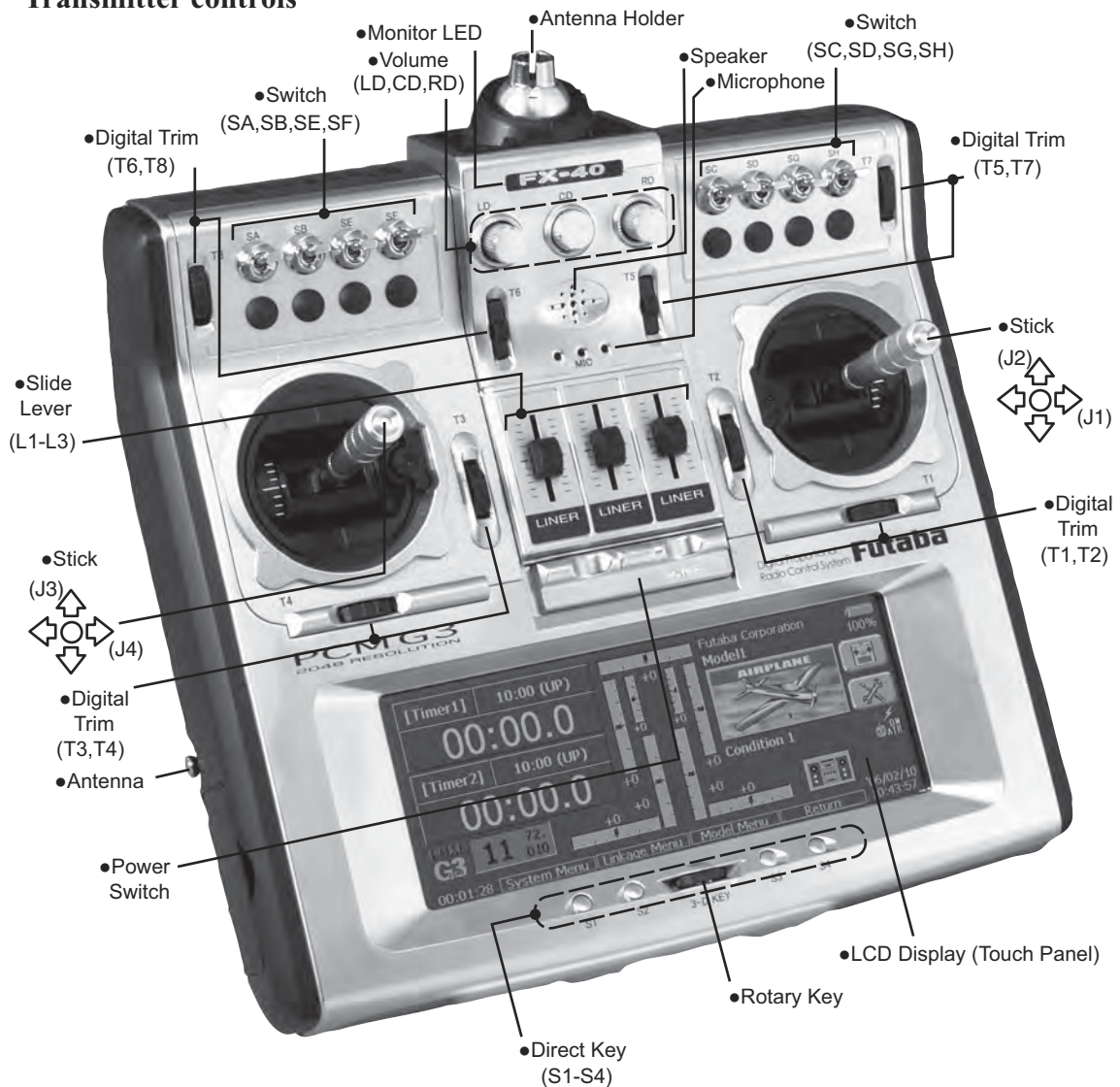

### Cautions on handling antenna

#### ⚠ WARNING

- ❗ Be sure to attach the antenna before operation.

\*Antenna is stored in the antenna storage box in the transmitter.

- ❗ Extend the antenna to the full extent, and make sure that the antenna is securely locked before operation.

- ⊘ Never hold the antenna alone.

### •Antenna storage

When you store the transmitter in the carrying case, detach the antenna and store it in the antenna compartment in the transmitter.



### •Angle adjustment of the antenna

You can change the angle of the antenna as you like. Use 2.5mm hexagonal wrench to turn counterclockwise to release the screw on the left of the antenna holder, and change the angle of the antenna as you like, then retighten.

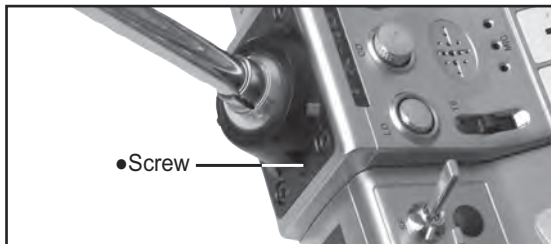

### LED monitor

The color of the FX-40 logo mark shows the status of the transmitter.

(LED Display)

- When you turn on the transmitter, FX-40 logo shows different colors, and then the color stays constantly pink. The FX-40 logo blinks yellow very rapidly while internal processing is carried out after the power is turned on. Once the internal processing is over, the logo turns to pink color.
- The FX-40 logo blinks blue slowly when No is selected for transmit.
- The FX-40 logo turns on blue when you use DSC cable or when the trainer function is set at student's side.
- The FX-40 logo blinks red slowly when you attach the RF module that is different from the setting.
- Under the normal usage (radio wave is being emitted), the FX-40 logo turns on green.

### Precautions when opening the rear cover and working inside

When opening the rear cover and performing switch replacement, stick tension adjustment, or other work inside the transmitter, open the rear cover as described below. Also, always observe the precautions.

1. Turn off the power to the transmitter.
2. Loosen the two fixing screws and remove the rear cover.

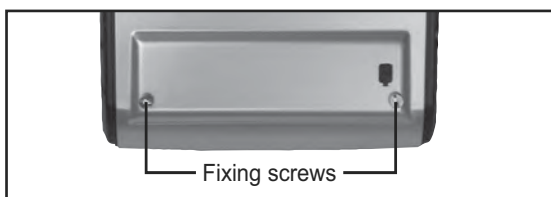

3. Remove the battery stopper by pulling it forward while pushing the lock button in the arrow direction. Next slide the battery out.

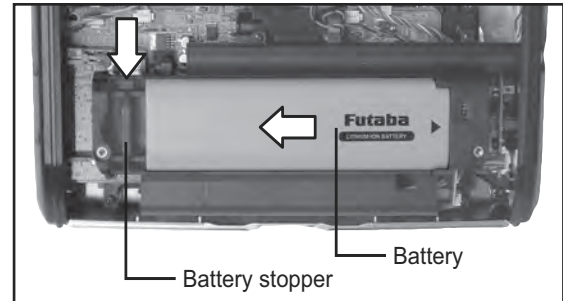

### ⚠ CAUTION

- ! When the rear cover is opened, always remove the battery before performing switch replacement or other work.

\*Dropping screws, tools, or other objects into the transmitter while performing work may cause a short circuit and damage the transmitter.

4. Replace the switch, etc. (Refer to each work item.)

### ⚠ CAUTION

- ! Be careful not to damage the internal PC board with a tool or other object during work.

- ! Be careful not to touch the protruding parts of the switch and PC board.

\*Touching protruding parts may result in injury.

5. At the end of work, reload the battery and fasten it with the battery stopper.
6. After fitting the antenna side of the rear cover, align the front side of the cover with the groove in the rear case and close the cover.
7. Fasten the cover with the two fixing screws.

### Switch reallocation

You can reallocate the toggle switches, as you like.

(Default settings)

- SA : 3 positions; Alternate; Short lever
- SB : 3 positions; Alternate; Short lever
- SC : 3 positions; Alternate; Long lever
- SD : 3 positions; Alternate; Short lever
- SE : 3 positions; Alternate; Short lever
- SF : 2 positions; Alternate; Long lever
- SG : 3 positions; Alternate; Short lever
- SH : 3 positions; Alternate; Short lever

\*You can choose switch and set the ON-direction in the setting screen of the function menu.

## [Replacement]

1. Turn off the power to the transmitter and then use the switch ornamental nut jig in the accessory tool box to remove the ornamental nut.

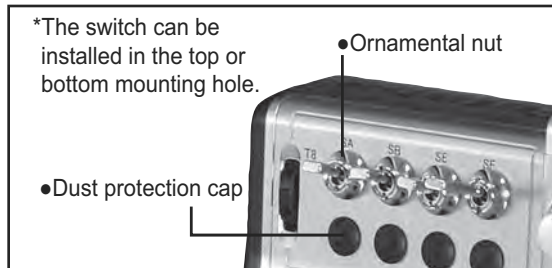

2. Open the rear cover, and remove the battery.  
(See [Precautions when opening the rear cover and working inside].)
3. Disconnect the connector of the switch you want to replace.

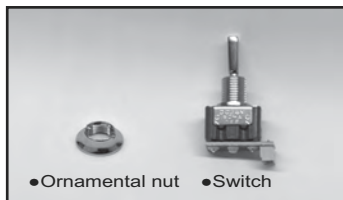
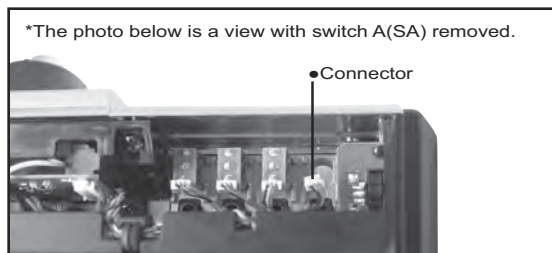

4. Use the ornamental nut to install the switch removed from another position, or an optional switch, to the switch mounting hole by the reverse procedure of the above.
5. Connect the connector.

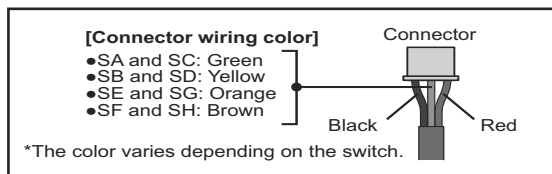

6. Install the battery and then close the rear cover.  
(See the preceding item.)
7. Change the setting at the [Important] System menu switch setting window to match the type of the new switch.

## Volume

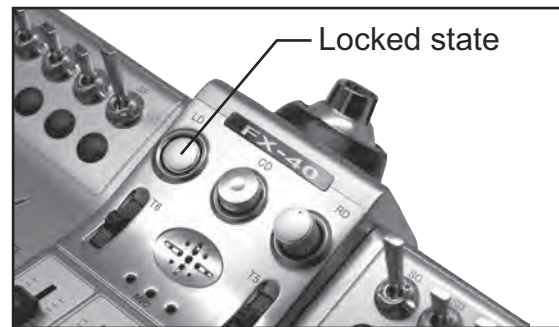

### Volume LD, CD, and RD:

If you push the volume (LD or RD) to the bottom, the volume will stay there. If you push the volume again, the lock will be released and become operative again.

This volume (CD) is digital type (rotary encoder). This volume works as both a volume and a push-switch.

\*FX-40 beeps when the volume knob reaches center.

\*You can check the volume position on the Dial Monitor screen in the Linkage menu.

\*You can use each setting screen of the mixing functions to select volumes and define the direction of its movement.

### Slide Lever

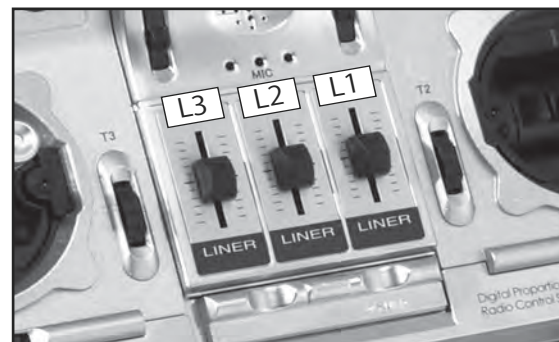

### L1 (right side), L2 (center), L3 (left side):

A click will be felt at the center of slide lever operation.

\*It sounds when the lever comes to the center.

\*You can check the lever position on the dial-monitor screen in the linkage menu.

\*You can select a slide lever and set the movement direction on the setting screen of mixing functions.



## Digital trim

This transmitter is equipped with 8 digital trims. Digital trims T1~4, T7, and T8 are rotary type and digital trims T5 and T6 are lever type. When the trim position is at the center, the tone will change. The trim position is graphically displayed on the home window at all times.

Each time T5 and T6 is pushed; the trim position changes a fixed step amount. If a trim button is held down, the trim position starts to change faster.

Note: The trim positions you have set will be stored in the non-volatile memory and will remain there.

## Touch Panel/ Rotary Key/ Direct Key

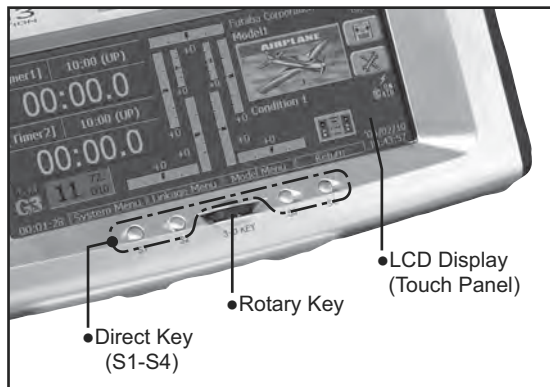

Touch panel, rotary keys and direct keys are used for entering data.

### Touch Panel

Touch the panel with your finger or the attached stylus pen, which is also used as a toolbox, to enter data.

### ⚠ Caution

❗ Touch softly the Touch Panel with the stylus pen or your fingertips.

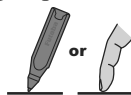

⊘ Never use your finger pad to push the Touch Panel.



\*It is strongly recommended to touch softly the Touch Panel with the attached stylus pen or with your fingertips. Never use your finger pad to push the Touch Panel. Using your finger pad would result in pushing a wide area of the Touch Panel, which may cause the difficulty of identifying your desired button because you might be touching more than one button at a time. As a result, this may mislead you to push

the Touch Panel much harder and destroy the glass sheet.

\*Plastic film is attached on the glass of the touch panel. Please be careful so that you don't scratch the touch panel with something hard, such as metal and sand sticking on the surface. And don't push the touch panel too hard and don't give any physical shock to the surface.

\*Although you may find some air bubbles under the plastic panel due to environmental changes such as temperature, it is not a defect.

### Rotary key

In addition to touch panel, you can select items by rotating the rotary keys to the left or to the right.

### Direct key

You can directly call your favorite functions or menu screens.

(The default setting at the factory)

- S1: System menu
- S2: Linkage menu
- S3: Model menu
- S4: Return

[How to change assignment of the direct key]

1. Open the screen you want to call. Then push S1 and S4 keys simultaneously. (You will see the direct key setting screen.)
2. Select the direct key.

## Stick Adjustment

### Adjustment of the stick lever angle

You can make fine adjustments to the angle of a stick lever either inwards or outwards from the center stick position.

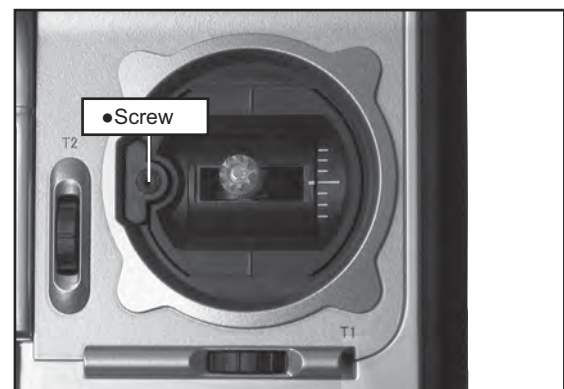

Use the attached 1.5mm hexagonal wrench (inside stylus) to turn the screw clockwise to adjust the stick outwards, or counter-clockwise to tilt it inward.

Note: The screw will fall out if you turn the screw counter-clockwise too far.



### Lever head modification and length adjustment

A long lever head is supplied with this set. Use it to replace the lever head, as you like. The length of the stick lever head can also be changed.

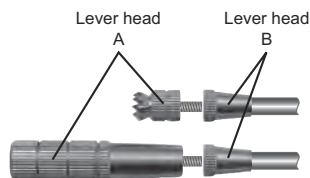

#### [How to adjust the length]

1. Hold the lever head "B" and turn the lever head "A" counter-clockwise, the lock will be released.
2. Turn the lever-head "A" clockwise as you hold the lever-head "B" after placing it as you like.

### Stick lever tension adjustment

The tension of the self-return type stick levers can be adjusted.

#### [Tension adjustment]

1. Turn off the power to the transmitter.
2. Open the rear cover and remove the battery. (See [Precautions when opening the rear cover and working inside].)

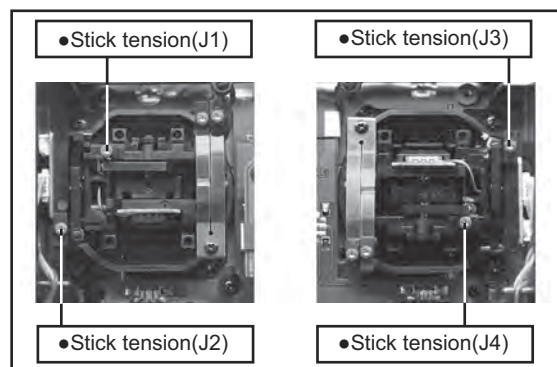

3. Use the accessory 1.5mm hexagonal wrench to turn the adjusting screw of the stick you want to adjust and set it as your prefer.

\*Turning the screw clockwise increases the tension.

4. At the end of adjustment, install the battery and close the rear cover. (See [Precautions when opening the rear cover and working inside].)

### Modification to ratchet system

When modifying the throttle stick from self-neutral system (factory installation) to ratchet system, use the accessory parts to change the corresponding switch to the mode (Mode 1 or Mode 2) used.

### [Modification]

1. Turn off the power to the transmitter.
2. Open the rear cover and remove the battery. (See [Precautions when opening the rear cover and working inside].)

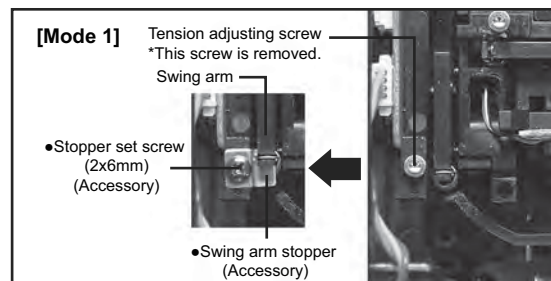

3. Use the accessory 1.5mm hexagonal wrench to remove the tension adjusting screw.

\*This screw is used only when returning to the self-neutral system. (Save it.)

4. Fasten the accessory swing arm stopper with the set screw as shown in the photo above. This frees the throttle stick.

\*Lock the stick at the low side or high side by some method so that the stick swing arm does not rise when installing the stopper.

\*Insert the stopper so that the swing arm is not returned by the spring. Align the notch of the stopper to the spring.

Next, adjust it to the tension you prefer.

### [Gripping force adjustment]

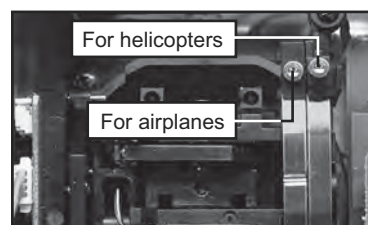

5. Use the accessory 1.5mm hexagonal wrench to turn the adjusting screw and set it as you prefer. Turning the adjusting screw clockwise increases the gripping force.

\*For airplanes: Adjust the screw on the left.

\*For helicopters: Adjust the screw on the right.

\*Free state when shipped from the factory.

\*This transmitter is equipped with two ratchet plates, one for airplane and the other one for helicopter. If you tighten both screws, you won't be able to achieve the adjustment that you need because of the overlap of those two adjustments.

\*If you want to change the setting from airplane to helicopter (or from helicopter to airplane), turn the currently set screw counterclockwise until the throttle stick moves freely. Then turn the screw you want to set clockwise until you get the tension you like.



6. After modification, install the battery and close the rear cover. (See [Precautions when opening the rear cover and working inside].)

## CF Card CFDP32M

CF (Compact Flash) card can store various files, such as model data, music, sound and pictures. Its memory size is 32MB.



### Warning

-  Be sure to turn off the power to the transmitter before inserting or removing the CF card.
-  As the CF card is a precision device, do not use excessive force when inserting.
-  Be sure to use only Futaba's original CF card, CFDP32M, for the T14MZ transmitter.

\* Futaba does not recommend any CF cards other than Futaba's original CF cards.

### CF card insertion/removal

1. Turn off the power to the transmitter and open the cover at the right side of the transmitter.
2. Insert or remove the CF card.

#### [Card insertion]

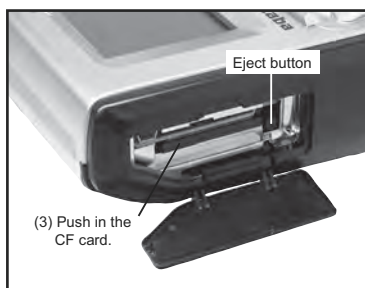
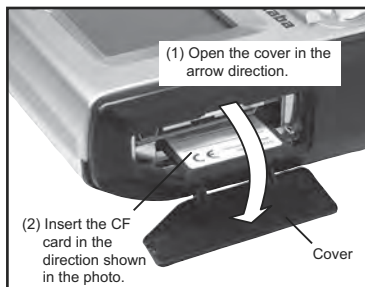

\*Turn the CF card so that the front of the card faces the back of the transmitter. Then slide the card into the slot.

\*Insert the card into the slot until it touches bottom. At the same time, push the eject button.

#### [Card removal]

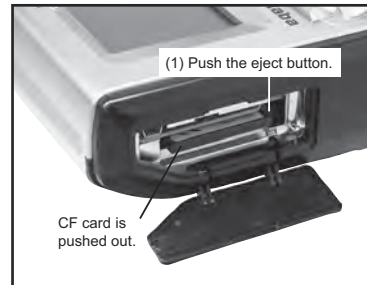

\*When the eject button is pushed; the CF card is pushed out and can be removed.

3. Close the cover.

#### Read data from a PC

Saving music and image files edited by a PC into the CF card, you can use those files on your FX-40 transmitter. Equipment for reading and writing CF cards are available at most electronics stores.

#### [Important]

Before saving data from the PC, insert the CF card into the transmitter and turn on the power. To save a file from the PC, copy the file to a folder by file type, which are automatically written.

- BMP: Picture file
- WAV: Audio file
- WMA: Music file
- MODEL: Model data

\*Use only CF card reader/writer that complies with CFA (CompactFlash™ Association) standard.

#### Stored data

The life of the CF card is limited due to the use of Flash memory. When you have a problem of saving or reading data such as picture data after a long period of use, please get a new CF card.

\*We do not have the responsibility of compensating any failure or damage to the data stored in the memory card no matter what the reason is. Be sure to keep the backup of your important data in your CF card.

\***No necessity for backup;** FX-40 transmitters and CF cards are using nonvolatile memory devices so that the data stored in those will not be destroyed even without a backup battery. The clock for the transmitter depends on the Lithium battery.

## Connector/Plug



### Connector for trainer function (TRAINER)

When you use trainer function, connect the optional trainer cable between the transmitters for teacher and student.

\*You can set the trainer function on the Trainer Function screen in the System menu.

### Connector for DSC function (DSC)

You can operate the transmitter without transmitting radio waves by connecting the transmitter and the receiver to the DSC cable.

\*Please refer to the section "Connection between Receiver/Servo"

### Audio plug (PHONE)

Connecting a stereo headphone to this plug, you can enjoy music files stored in the CF card.

### Connector for battery charger (CHG)

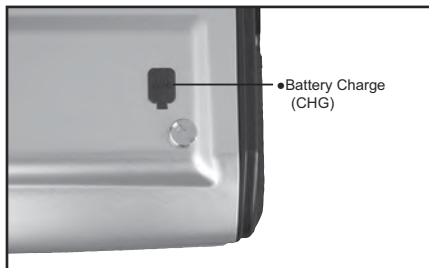

This is the connector for charging the Lithium Ion battery LT4F5000 that is installed in the transmitter. Do not use any other chargers except LBC-2E5 or CR-2500 that is for 12V application to charge the LT4F5000 battery through this connector.

## **⚠ Danger**

**⊘** Do not connect any other chargers except LBC-2E5 or CR-2500 to this charging connector.

## USB port (Transmitter right side)

\*This is for factory use only.



## Installing and Removing of the battery LT4F5000 for the transmitter

### Installing the battery

1. Open the rear cover. (See [Precautions when opening the rear cover and working inside and working inside].)
2. Remove the battery stopper by pulling it forward while pushing the lock button in the arrow direction.
3. Install the battery by sliding it in the horizontal direction.
4. Fasten the battery by re-installing the battery stopper.

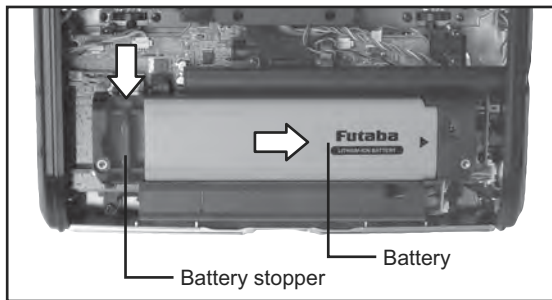

5. Close the rear cover. (See [Precautions when opening the rear cover and working inside].)

### Removing the battery

When removing the battery, always turn off the power to the transmitter. If the battery is removed while power to the transmitter is on, the set data will not be saved.

1. Turn off the power to the transmitter.
2. Open the rear cover. (See [Precautions when opening the rear cover and working inside].)
3. Remove the battery stopper by pulling it forward while pushing the lock button in the arrow direction. Then remove the battery by sliding it horizontally

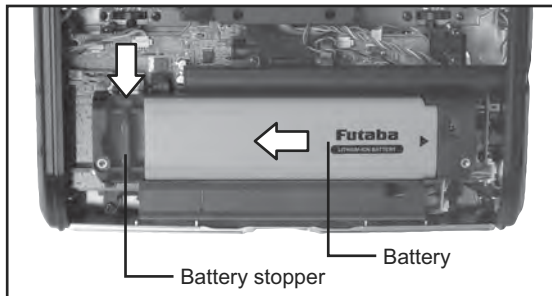

## ⚠ Warning

- ❗ Be careful to not drop the battery.

- ⊘ Never take out the battery from the FX-40 transmitter while the LED monitor is blinking yellow after turning off the power the FX-40 transmitter.

\* Internal devices such as memories may have been destroyed.

\* If there is any problem, the message "Backup Error" will be shown the next time when you turn on the power of the transmitter. Do not use the transmitter as it is, send it back for a check to the Futaba Service Center.

### RF module FX-FM

To change the frequency band, use the FX-FM module which is sold separately.

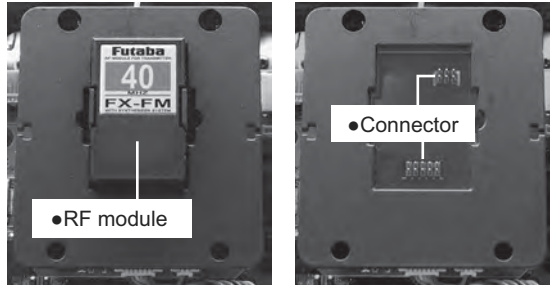

### ⚠ CAUTION

❗ Turn off the power to the transmitter before you remove or install the module.

#### Removing the RF module

1. Turn off the power to the transmitter.
2. Open the rear cover. (See [Precautions when opening the rear cover and working inside].)
3. Grip the tabs at the left and right sides of the module and pull the module straight out.

\*There are two connectors; one at the top and one at the bottom. If the module is not pulled out straight, it will be difficult to remove.

#### Installing the RF module

1. Insert the module until it bottoms while being careful not to bend the pins of the transmitter side connector.

### Toolbox

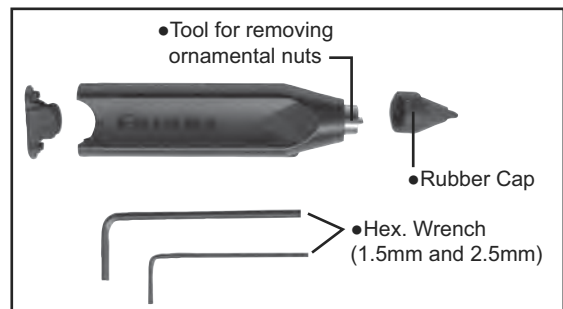

You can use the toolbox contained in the set for various adjustment of the transmitter.

#### Hexagonal wrench (1.5mm and 2.5mm)

These wrenches are for adjustment of sticks, replacement of the switches and adjustment of the antenna.

#### Tool for removing ornamental nuts

This is for replacement of switches.

#### Stylus pen

Rubber cap is attached on the tip of the tool. You may use this tool as a stylus pen for operating the touch panel. This stylus pen can let you do more precise operation than fingers without damaging the surface.

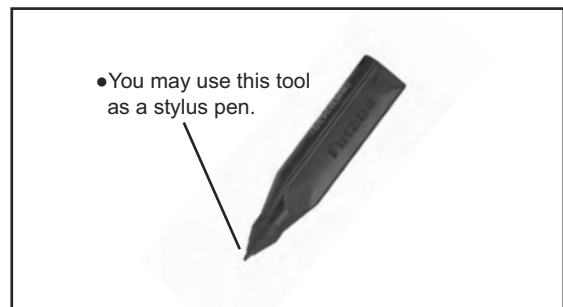

## Receiver nomenclature

Before using the receiver, be sure to read the precautions listed in the following pages.

### Receiver R5014DPS

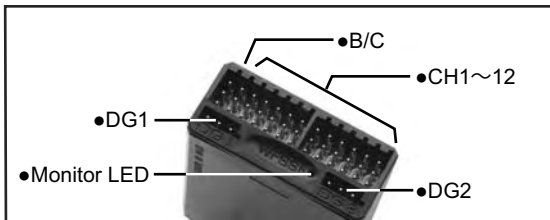
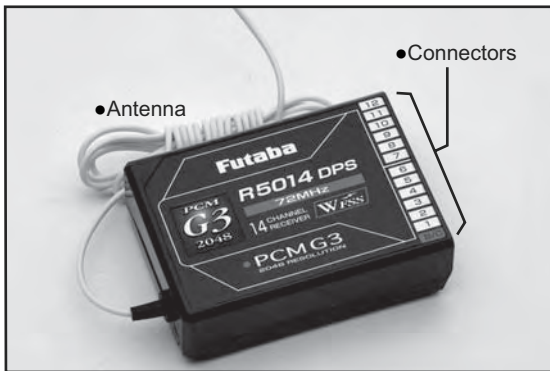

### Connector

"1 through 12": outputs for the channels 1 through 12

"DG1", "DG2": outputs of DG1 and DG2 channels

"B/C": connector for the power and DSC.

### LED Monitor

This monitor is used to check the frequency change of the receiver.



## Safety precautions when you install receiver and servos

### Warning

#### Connecting connectors

- ! Be sure to insert the connector until it stops at the deepest point.

\*If a connector comes out during the flight due to some reasons such as vibration, your aircraft will crash.

#### How to protect the receiver from vibration and water

- ! Wrap the receiver with something soft such as foam rubber to avoid vibration. If there is a chance of getting wet, put the receiver in a waterproof bag or balloon.

\*Strong physical shock or water infiltration may damage the receiver and let the receiver malfunction to crash your aircraft.

#### Receiver's antenna

- ⊘ Never cut the receiver's antenna. Do not bind the receiver's antenna with the cables for servos.

- ! Locate the receiver's antenna as far as possible from metals such as frames.

\*Cutting or binding the receiver's antenna will reduce the radio reception sensitivity and the flight area, causing the crash.

#### Servos throw

- ! Adjust your system so that pushrods will not bind or sag when operating the servos to the full extent.

\*If excessive force is continuously applied to a servo, your aircraft may crash because the servo would be damaged and the battery voltage would be consumed rapidly.

#### Mounting servos

- ! Use a vibration-proof rubber (such as rubber grommet) under a servo when mounting the servo on a servo mount. And be sure that the servo cases do not touch directly to the metal parts such as servo mount.

\*If a servo case is in direct contact with the airframe, the vibration of the airframe directly travels to and may damage the servo.

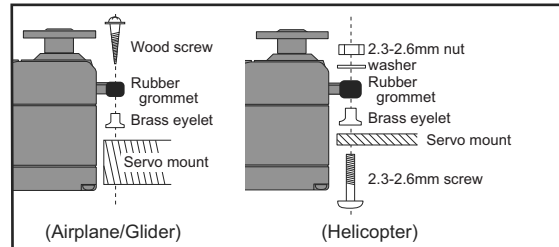

#### Fastening of servo lead wire

- ! To prevent the servo lead wires from being broken by vibration during flight, provide a margin so that the wire sticks out slightly and fasten it at suitable points. In addition, periodically check the wire during daily maintenance.

##### [Fastening example]

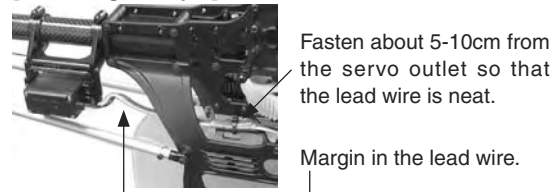

#### Internal antenna mounting (Airplanes)

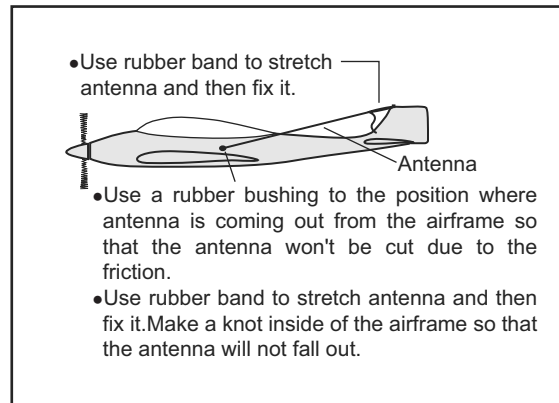

#### Mounting the power switch

When mounting a power switch to an airframe, make a rectangular hole that is a little larger than the total stroke of the switch so that you can turn ON/OFF without binding.

Avoid mounting the switch where it can be covered by engine oil and dust. In general, it is recommended to mount the power switch on the side of the fuselage that is opposite the muffler.

## BASIC OPERATION

### Battery Charging

Before charging batteries, read the "Cautions for handling battery and battery charger" in the section "For your safety".

### How to charge the Lithium Ion battery LT4F5000 for the transmitter

#### **⚠ DANGER**

⊘ The Lithium Ion battery LT4F5000 is only for your FX-40 transmitter. Do not use this battery with other equipment.

⚠ Always use the accessory battery charger LBC-2E5 to charge the battery.

\*The battery can also be charged with the battery charger CR-2500 sold separately.

#### Charging method

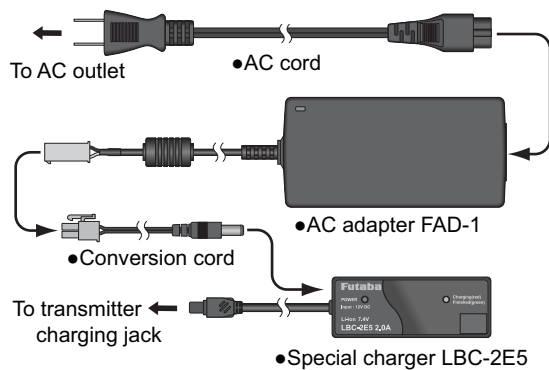

1. Connect the AC adapter, charger, and transmitter as shown in the figure.

\*When connected to the AC outlet, the LED (green) of the AC adapter lights. The charger POWER LED (red) also lights.

\*The charge LED of the charger lights red and charging starts.

2. When the charge LED of the charger changes to green, charging has been completed.

\*After charging, always unplug the power cord from the AC outlet.

\*It takes about 5 hours to charge a battery that has been used fully. However, the charging time varies depending on the surrounding air temperature and the condition of the battery pack.

\*The charge LED will not light if the battery is improperly mounted, or there is a connection problem. Remount the battery, or check the connections.

\*When a charged battery is mounted, the charge LED lights green.

\*The battery will self-discharge even when not used. Always charge a new battery before use. Also, when the battery has not been used for a long time, always recharge it before use.

### How to charge the Ni-Cd battery NR4F1500 for the receiver (Optional)

Use the battery charger FBC-32A (Optional).

#### [Method of charging battery]

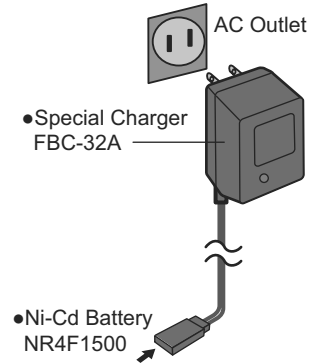

1. Connect the power cable of the charger to the wall socket (AC outlet).

2. Connect the connector to the NiCd battery.

\*Confirm that the charging indicator, LED lamp, is on.

3. Remove the battery after 15 hours.

\*Battery charging will not automatically stop. Remove the battery from the charger and remove the charger from the wall socket.

\*It is recommended to reactivate the battery by cycling several times if the battery has not been used for a long period.

\*In case of NiCd battery, you may find the poor performance of the battery if you have used the battery only for a short period or if you repeat charging while the battery is not fully discharged. It is recommended to discharge the battery to the recommended level after your usage. It is also recommended to charge the battery just before your usage.



## How to turn ON/OFF the power of the transmitter

Windows® CE is installed as a built-in operating system in the FX-40 transmitter. Compared to the conventional system, the FX-40 takes extra time for internal processing when it is turned on/off. For safety reasons, the radio will be emitting only after you push the confirmation button when turning on the power. Please follow the instructions for turning on/off the transmitter.

### When turning on the power of the transmitter

1. Turn on the power switch of the transmitter.

\*After initialization of the transmitter is over, the frequency confirmation screen pops up, and LED monitor turns on pink.



2. Check the frequency shown on the screen. If it is OK, then click the button "YES".

\*LED monitor turns to green and the transmitter begins to emit radio waves.

\*If you push the button "NO", then the transmitter will not emit radio waves.

Then, you will see the home screen and you will be able to set conditions.

**Start-up time;** The time required for initializing the internal circuit of the transmitter varies between the previous time you turned off the transmitter and the time you will turned on the power. There are two "start up" modes for your transmitter, see below:

#### Cold start;

If you turn on the transmitter more than four hours after you last turned it off, the mode is "Cold start". "Cold start" is normal for the first initial power up of the day. It will take about 30 seconds to be ready for use, as it takes time to initialize the internal circuit of the transmitter.

#### Hot start;

If you turn on the transmitter less than four hours after you last turned it off, the mode is "Hot start". Since initialization has been partly completed, the transmitter will be ready to use in several seconds. "Hot start" takes place usually at a second flight or later flight in the day.

## Warning

- ⊘ Once you turn on the power, never shut off the power switch until the power becomes stable (or until the first screen shows up). If you turn off the power switch while the transmitter is going through the initialization process, the data could be damaged. Note: The start-up time may be a little bit slower when the CF card is installed compared to when the card is not.

### How to stop the transmitter

Turn off the power switch of the transmitter. The internal circuit of the transmitter starts the shut down process including saving the set-up data. The LED will blink yellow while the transmitter is in the shutdown process.

- ⊘ Once you turn off the power, never operate the power switch until the power shutdown process is fully completed. If you turn on the power switch again while the transmitter is still in the process of power shutdown, the data could be damaged.

As the internal circuit of the transmitter stays on the standby mode for 4 hours after turning off the power, some part of the circuit is consuming current. When you turn on the power during this period, the power starts in "Hot mode". But if more than four hours pass after shutting down the power, the power supply will completely shut down the internal circuit. When you turn on the power after this point, the power starts in "Cold start mode".

### How to reset software

If the screen freezes for some reason and you cannot edit, the transmitter power supply is not shut off even if you turn OFF the power switch. You will need to remove the battery and reinsert it again. In this case, the power restarts in "Cold mode". Even though the screen freezes, all the other functions for radio control operation remain operative.

## How to change the frequency/How to set ID

The FX-40 system has employed the frequency synthesizer scheme. The FX-40 transmitter will set the frequency of the R5014DPS (PCMG3 receiver) by the wireless data transmission. When you are using a new PCMG3 receiver and changing the frequency, set ID or frequency by the following instructions.

### In case of using PCMG3 receivers

\*Make sure that PCM-G3 is set as a modulation scheme. Then change the frequency by the following instruction.

#### How to change the frequency

1. Turn on the power of the transmitter.
2. Push the area that shows the frequency in the home screen or push the "Frequency" button in the Linkage menu. Then the Frequency Set screen will pop up.



3. Push the "Receiver ID" button. Then ID inputting screen for receiver will pop up. Input the eight-digit ID code attached to the receiver's case. Push the "Yes" button after confirming the ID.

\*Use the "BS" button to move back digit by digit for correction if you made a mistake. If you want to stop changing ID code halfway, push "Return" button to return to the previous screen.

\*Once you set the ID code for a receiver, you don't have to set the ID code again as long as you change the receiver itself.

\*When you need to use two receivers for a large size aircraft, you need to enter different ID codes to those receivers respectively.

4. Push the "Band NO. (Frequency)" button if you need to change the frequency. Then you will see frequencies on the screen. Select the frequency you want use. Push the button "Yes" after confirmation. Then you will see the "Confirmation of the change" box.

\*If you have changed the module prior to turning on the power, confirmation screen will pop up to ask you whether you want to change the frequency. Push the button "Yes" to change the frequency.

5. If the frequency is correct, push the button "Yes". Then you will see the message "Transmitting the frequency data". It takes a certain time to send the new frequency data to the receiver with a sound. (If you need to resend the data, push the "Resend" button.)

6. Turn on the power of the receiver while the

new frequency data is displayed. When the frequency setting for the receiver is completed, the LED monitor of the receiver blinks once and the 1CH servo shuttles three times across the neutral position.

\*A very low power, whose frequency is different from that of the channel frequency, is used to set the frequency of the receiver. The reachable distance of the radio is designed to be within several feet. Therefore, put the transmitter and the receiver as close as possible when setting the frequency of the receiver.

- \* If the receiver can not load the new data due to environmental reasons, connect the transmitter and the receiver directly by the DSC cable. And do the procedure 5 and 6.

\*LED monitor will blink on and off if the receiver's ID code is wrong. Then move back to the Receiver ID Set screen and restart the receiver's ID setting from the beginning.

7. Push the button "End" when the frequency setting is completed. You will be able to use the new frequency after you push the button "Yes".

### In case of using PCM1024, PPM receivers

\*Make sure that PCM1024 or PPM is set as a modulation scheme. Then change the frequency by the following instruction.

#### How to change the frequency

1. Turn on the power of the transmitter.
2. Push the area that shows the frequency in the home screen or push the "Frequency" button in the Linkage menu. Then the Frequency Set screen will pop up.



3. Push the "Band NO. (Frequency)" button if you need to change the frequency. Then you will see frequencies on the screen. Select the frequency you want use. Push the button "Yes" after confirmation. Then you will see the "Confirmation of the change" box.

\*If you have changed the module prior to turning on the power, confirmation screen will pop up to ask you whether you want to change the frequency. Push the button "Yes" to change the frequency.

4. If the frequency is correct, push the button "Yes". You will be able to use the new frequency after you push the button "Yes".

---

## Registration of the user's name

FX-40 transmitter can register user's name.

### How to register user's name

---

1. Turn on the power of the transmitter.
2. Push the area of the user's name shown on the home screen or the "user's name" in the linkage menu. Then the User's Name set screen will pop up.



3. Push the user's name. Then the keyboard will pop up. You can use up to 32 characters as a user's name. Use the keyboard on the screen to enter user's name.

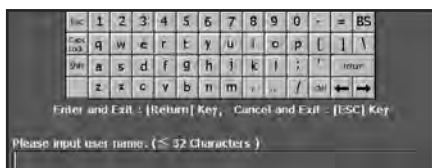

space key

4. Push "Return" key to return to the previous screen after entering the user's name.

### (If you want to protect the user's name)

---

If you don't want anybody else to change your user's name, set your ID in the following way.

\*Please be aware that you will not able to change user's name if you forget your password.

1. Make sure that the security mode is "User's name", and then push the User ID button.
2. Enter your password, using keyboard on the screen.

You will need to enter your password for changing the user's name from the next time you turn on the power of the transmitter.

\*Even if you enter the same character, your password will be identified differently depending on whether you are using "Transform" mode or "Direct" mode for inputting.

## Home screen

Here is the home screen and its descriptions. Use your finger or included stylus pen to operate the touch screen.

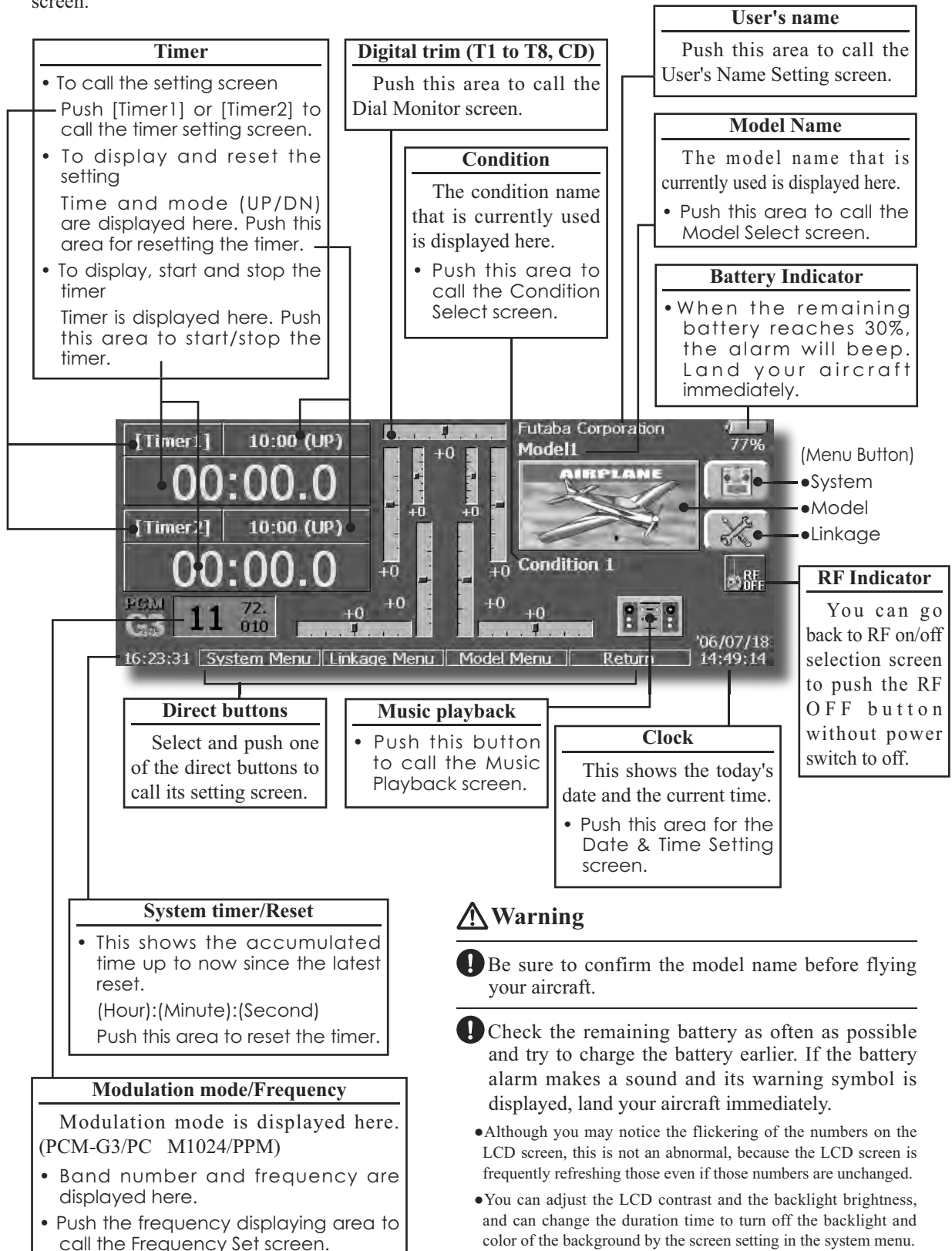

## Music playback

The FX-40 transmitter can play back the ".wma" music files stored in the CF (Compact Flash) card. You can listen to them through the built-in speaker or a headphone by the earphone plug.

\*First, store music files from your PC into the WMA folder on the CF card, and then insert the CF card into your transmitter to play back music files on the transmitter.

### [Important notice]

Before downloading files from your PC into the CF card, insert the CF card into the transmitter and turn on the power of the transmitter. Then the following folders will be automatically created in the CF card. When you download files from you PC, copy and paste the files into their corresponding files.

- BMP : picture files
- WMA : music files
- WAV : sound files
- MODEL : model data files

- Push the Music Playback button on the home screen to call the following set-up screen.

• Return to the home screen

• Button to select either One-time Playback or Repeat Playback

• Button to select either One Music Playback or Multiple Music Playback

• SW selection button  
Push this button to call the SW select screen and choose the Music playback switch.  
(Refer to the description in the end of this manual)

**Buttons for music playback**

- You can playback any music files listed on the right side of the screen.
- If you adjust the volume here, it adjusts not only music playback but also other applications.

(Playback file list)

**To playback**

- All the music files saved in the CF card will be shown here.

1. Push the file name to select the music file you want to hear.
2. Use the buttons on the left to playback or stop the music.

---

## SYSTEM MENU

The System Menu sets up functions of the transmitter, this does not set up any model data.

- When the System Menu button is touched, the menu shown below is called. Call the setup screen by pressing the function you want to set up.

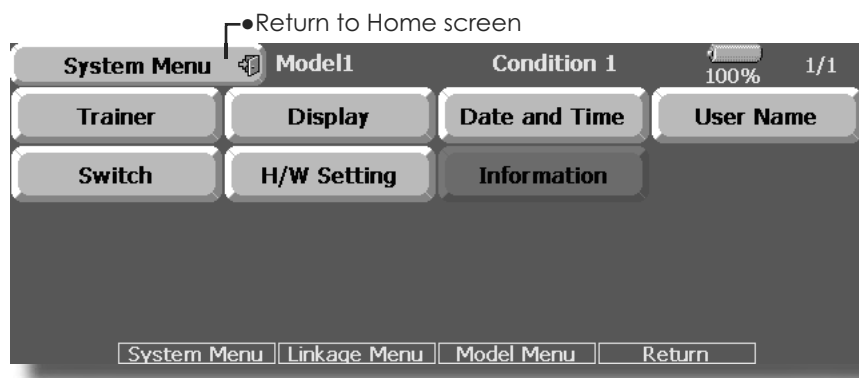

---

### System Menu functions table

[Trainer]: Starts and sets the trainer system.

[Display]: Display adjustment and auto power off setting.

[Date & Time]: Sets the date and time (system clock setting) and resets the timer.

[User Name]: User name registration and ID Pin number.

[Switch]: Toggle switch type setting (Set when the switch is replaced.)

[H/W Setting]: Hardware reverse and Stick setting.

[Information]: Displays the program version, CF card information, and product ID.

FX-40 trainer system makes it possible to choose which channels and operation modes are to be used at the instructor's transmitter. Because the switch and rate of each channel can be set, the training method can also be matched to the student's skill level. Two transmitters must be connected by an optional Trainer Cord, and the Instructor's transmitter should be programmed for trainer operation, as described below.

When the Instructor activates the trainer switch, the student has control of the aircraft (if MIX or FUNC mode is turned on, the Instructor can make corrections while the student has control). When the switch is released the Instructor regains control. This is very useful if the student gets the aircraft into an undesirable situation.

- Setting data are stored to model data.
- Student rate can be adjusted at MIX and FUNC mode.
- Activated student channels can be selected by switches.

**NOTE:** This trainer system can be used in the following manner;

1. In the FX-40 transmitter and a conventional transmitter, if the channel order is different. It is necessary to match the channel order in the Function Menu when connecting it with other than a FX-40.
2. When the T14MZ is used as the Teacher, set the modulation mode of the student's transmitter to PPM. If being used as the student, set the FX-40 to the modulation mode specified by the Instructor's transmitter. When the Instructor's transmitter is a T14MZ, FX-40, 12Z, T9Z, T9C or T7C transmitter, it should be switched to PPM mode.
3. Be sure that all channels work correctly in both transmitters before flying.

<b>Corresponding types of transmitters:</b>
T4VF, T6YG, T6YFK, T6X, T6EX, T7U, T7C, T8U, T9C, T9Z, 12Z, FX-40, T14MZ
<b>Non-corresponding types of transmitters:</b>
T6VA, T6DA

- Touch the [Trainer] button at the System Menu to call the setup screen shown below.

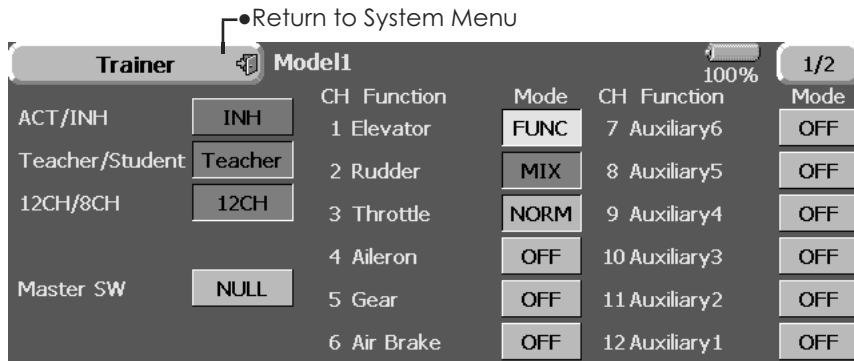

(The display screen is an example. The screen depends on the model type.)

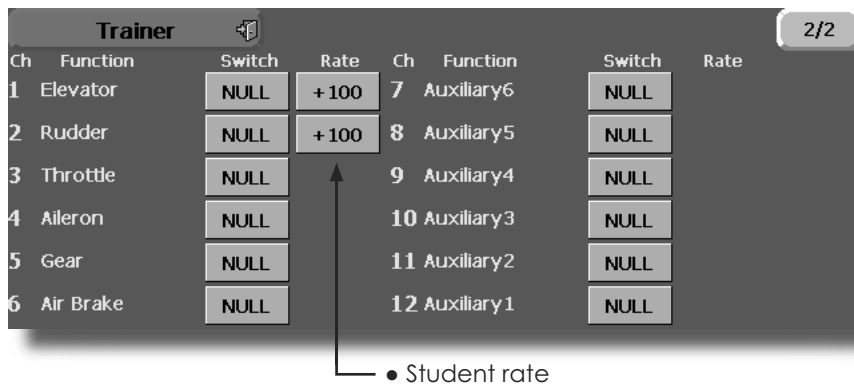

### Teacher mode

1. Set "Teacher/Student" button to "Teacher".
2. Change "ACT/INH" button from "INH" to "OFF" or "ON".
3. Set "12CH/8CH" to "12CH" when the student is using FX-40. Otherwise set it to "8CH".
4. Call up the Switch Setting screen by touching "Switch". Then set the desired switch and on/off direction.
5. Select the switch mode. If you select "NORM", the trainer function will be turned on or off by a switch position. If you select "ALT", ON and OFF of the trainer function switches alternatively every time the switch is turned on. This means the student side can be operated without holding the switch lever.
6. The Instructor side selects the channel for control. Three operating modes are available.

#### "NORM" mode (Normal mode);

Student side has no control of mixes and settings in Teachers radio..

#### "MIX" mode;

Student has full advantage of all setting in Teachers radio, plus Teacher has the option to change any setting while Student has control.

### "FUNC" mode (Function mode);

Student has control of mixes and rate settings of Teachers radio.

7. Set the switches and rates of each channel.  
Switch to the details setup screen by touching the page switching button [1/2] at the top right-hand corner of the screen. Student operation for each channel can be set here.

[Switch]: The switches that can be operated by the student can be set. SW-A~SWH, SS1, and SS3 can be selected.

[Rate]: Servo travel versus student operation can be set. (This can only be used in the FUNC and MIX modes.)

### [Notes]

1. In the teacher mode, the trainer function display does not come on as long as the student's transmitter is not receiving signals from the teacher's transmitter (when the student's transmitter is not connected).

- The setup screen for the student mode is shown below.

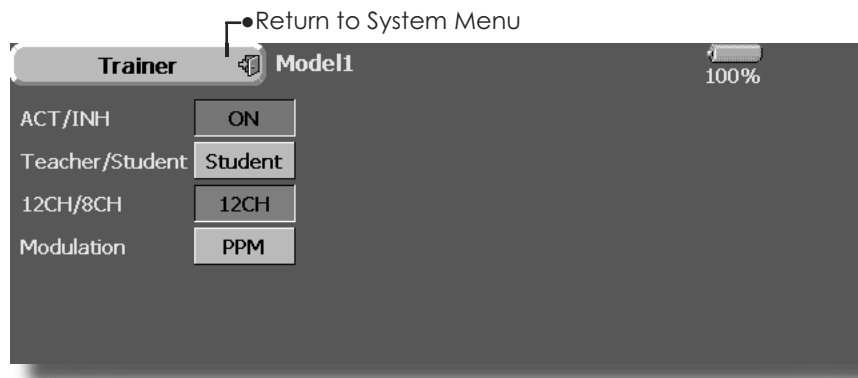

### Student mode

1. Set "Teacher/ Student" button to "Student".
2. Change "ACT/INH" button from "INH" to "OFF" or "ON".
3. Set "12CH/8CH" to "12CH" when the Instructor is using the FX-40. Otherwise set it to "8CH".

Note: In "student mode", only the teacher side can turn on and off the power of the student's transmitter. Keep the power switch always at off position. Note: In "teacher mode", the trainer function won't be turned on unless the Instructors' transmitter receives signals from the student's transmitter. Be sure to confirm this after connecting your trainer cable.



The following LCD screen adjustments and auto power off setting are possible:

- Contrast adjustment
- Auto power off time setting
- Backlighting brightness adjustment
- Background color change
- Touch panel screen position correction

- Touch the [Display] button in the System Menu to call the setup screen shown below.

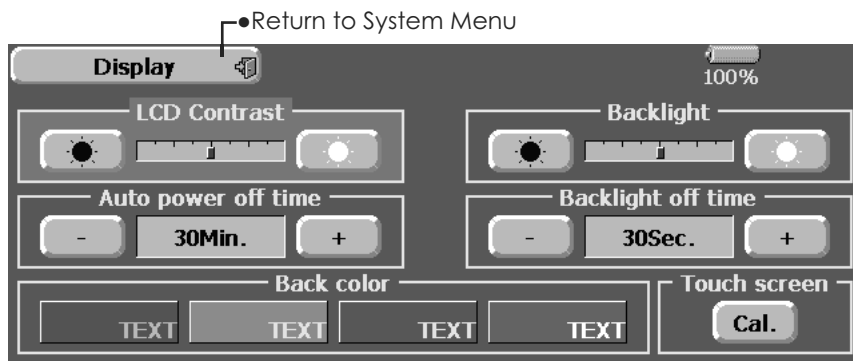

### LCD contrast adjustment

1. Adjust the LCD contrast with the left and right side buttons.

\*When the right side button is pressed, the LCD contrast decreases. When the left side button is pressed, the LCD contrast increases.

### Auto power off time setting

1. Adjust the auto power off time with the left and right side buttons.

\*When the time the transmitter is inactive exceeds the set time, the power is turned off automatically. This time can be set up to 1 hour in 10 minutes increments. The auto power off function can also be deactivated.

### Backlighting brightness adjustment

1. Adjust the backlighting brightness with the left and right side buttons.

\*When the right side button is touched, the backlighting becomes brighter. When the left side button is touched, the backlighting becomes darker.

### Backlight power-off time

You can set a time period to turn off the LCD backlight. This function counts the period that the touch panel has been not operated. This time can be set by ten-second steps. You can also turn off the backlight-power-off" if you like.

\*The backlight consumes a large amount of power. We recommend you to turn off the backlight by setting the backlight power-off time to about one minute.

### Background color

1. Touch the button of the color you want to change.

\*There are four background colors.

### Touch panel calibration

This function adjusts the location of the touch panel. Touch "Calibration" button and then press "Yes", the calibration screen will pop up. Touch the center of the cross hair cursor on the screen with the stylus pen. As soon as the system recognizes the position, the cursor will move on to the next position. Repeat this procedure as long as the cursor moves to next position. You will do this five times. Calibration will be carried out based on the five positions. Disappearance of the cross hair cursor means the calibration has been completed. Touch any point on the screen to return to the previous screen.

\*In ordinary operation, this calibration is not necessary. If you notice the touch panel is not functioning correctly after long use, we recommend you to carry out this calibration.

## Date and Time

Date and time setting (system clock setting) and integrating timer resetting

This function adjusts the system clock of the FX-40 transmitter. Perform this setting when you purchase the set and when adjustment is necessary.

The integrating timer can also be reset.

\*The integrating timer is displayed on the Home screen.

- Touch the [Date and Time] button in the System Menu to call the setup screen shown below.

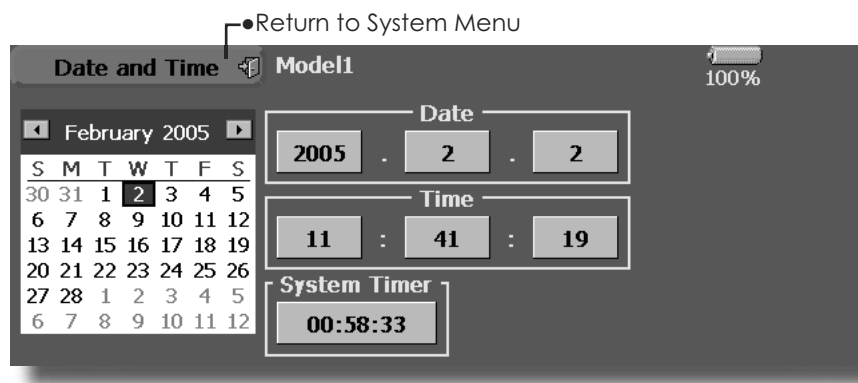

### Date setting

1. Touch the "Year", "Month", or "Day" button and set the date by touching the [+] or [-] button.

\*The date can also be set by pressing the date on the calendar shown at the left.

### Time setting

1. Touch the "Hour" or "Minute" button, and set the time by touching the [+] or [-] button.
2. When the "Second" button is touched, the timer is set to "00" seconds.

### Integrating timer reset

The integrating timer shows the total time that has elapsed since the last resetting.

1. When the [System Timer] button is touched, the timer is reset.

## User Name

### User name registration and PIN setting

This function registers the FX-40 user name.  
A PIN can also be set to protect the data or user name.

\*Set the PIN carefully. When a system PIN is set, if you forget the PIN, none of the settings can be changed. In this case, the system must be reset by the Futaba Service Center.

- Touch the [User Name] button at the System Menu to call the setup screen shown below.

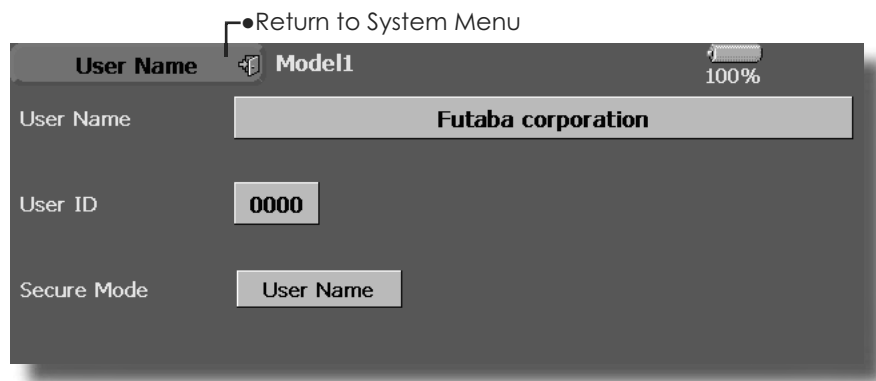

#### User name registration

1. When the User Name box is touched, a keyboard appears on the screen.
2. Enter the user name from this keyboard.

\*A user name of up to 32 characters can be entered.

\*The set user name is displayed on the Home screen.

(For a detailed description of the input method, see [User Name Registration/Character Input Method] in the Basic Operation section.)

#### User name or set data protection

1. Touch the Security Mode button and select the mode. The mode is switched each time the button is touched.

\*User Name: Select when you want to protect the user name only.

\*System: Select when you want to protect all the set data.

2. When the user ID button is touched, a PIN input screen appears. Input a PIN of up to 4 digits.

3. When the "Return" key is touched 2 times, the display returns to the preceding screen.
4. When the transmitter power is turned off, the set security mode becomes active.

\*When a PIN is set at the user name, it must be entered the next time the User Name screen is opened.

When a System PIN is set, a button displaying a key icon appears on the Home screen.

When you want to change the setting, touch this button and enter the PIN.

If you want to nullify your current password, set the password to "0000" (default value).

## Switch Toggle switch type setting (Setting when a switch was changed.)

If you modify the location of the switches on the right and left (top) of the transmitter, you should be sure to re-assign functions to the switches for proper operation.

A "Lock" is included to prevent settings from being modified by mistake. When you need to change settings, unlock this by pressing "Lock" it will then read "Unlock" and you can make changes as required.

- Touch the [Switch] button at the System Menu to call the setup screen shown below.

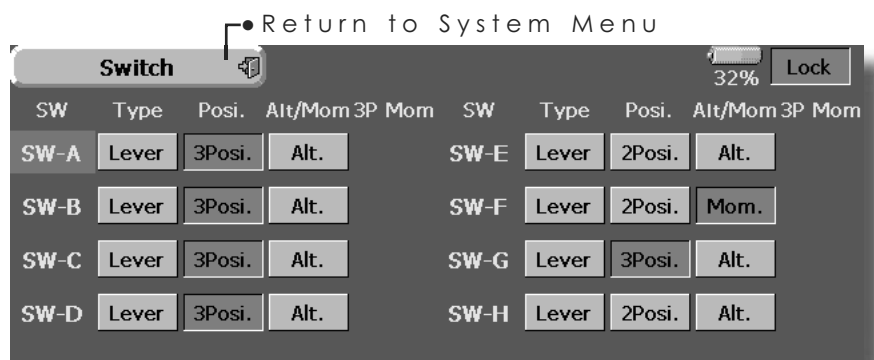

### Switch selection

1. Select the switch type by touching the [type] button corresponding to the switch to be replaced.

[Lever]: Toggle switch

[Button]: Pushbutton

[Dial]: Knob

- Setting for toggle switch is shown above.

### 2/3 position selection

1. Touch the "Posi." button corresponding to the switch and select the position type.

[2 Posi]: 2 position

[3 Posi]: 3 position

### [Alt/Mom] mode selection

1. Select the operation mode by touching the [Alt/Mom] button corresponding to the switch.

[Alt.]: Alternate type

[Mom.]: Self-return type

- Selection of the [Mom.] mode with a 3-position type switch is shown above.

### "3P Mom" mode selection

1. Select the operation mode by touching the "3P Mom" button corresponding to the switch.

[Single]: One-side self-return type

[Dual]: Both directions self-return type

## H/W Setting

Stick, switch, trim lever, and knob operation direction reversal (Hardware reverse)/Stick response and histerisis adjustment (Stick Setting)

### H/W Reverse

This function reverses the operation signal of the sticks, switches, trimmer levers, and knobs.

**Note:** This setting reverses the actual operation signal, but does not change the display of the indicators on the display. Use the Normal mode as long as there is no special reason to use the Reverse mode.

### Stick Setting

This function sets the servo response and hysteresis for stick operation for each condition. The control feeling of the stick can be adjusted to match the aerobatics.

- Touch the [H/W Setting] button at the System Menu to call the setup screen shown below.

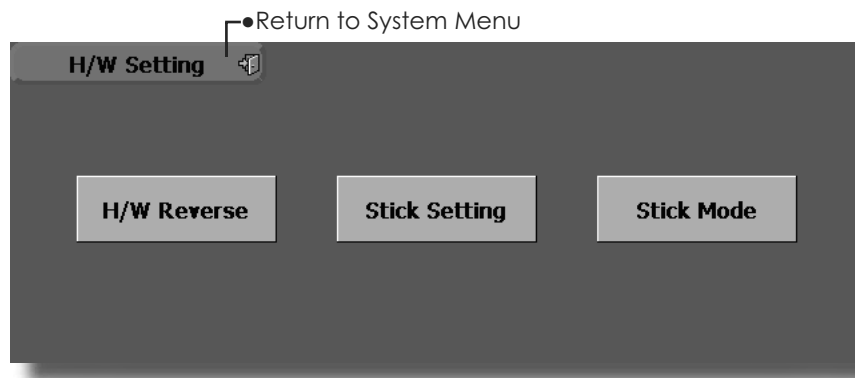

- Touch the [H/W Reverse] button at the H/W Setting Menu to call the setup screen shown below.

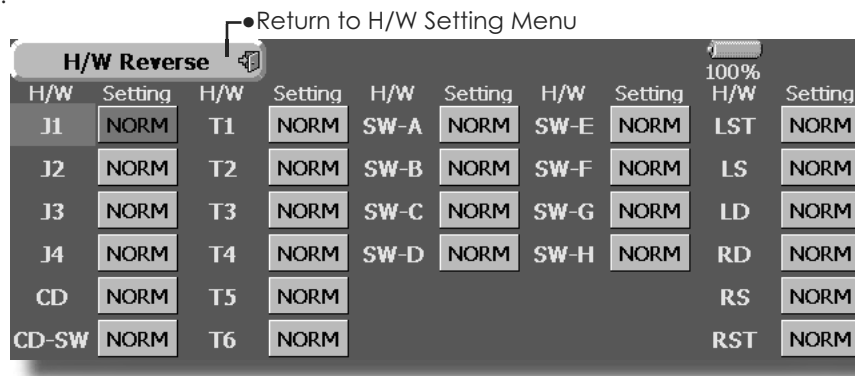

### Operation direction reversal method

1. Touch the setting button corresponding to the H/W (Hardware) you want to reverse.
2. Reverse the H/W by touching [Yes]. (When you want to stop operation, touch [No].) [Normal]: Normal operation direction [Reverse]: Reverses the operation direction.

- Touch the [Stick Setting] button at the H/W Setting Menu to call the setup screen shown below.

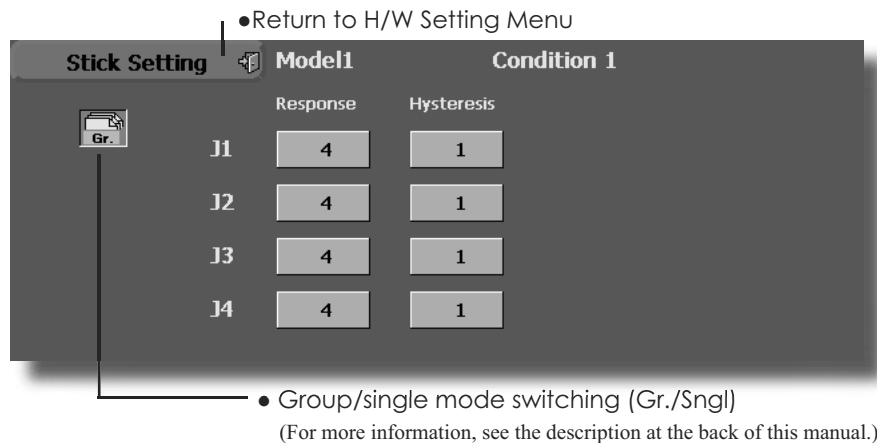

### Response adjustment

1. Touch the setting button corresponding to the stick whose response you want to adjust. Adjustment buttons appear on the right-hand side of the stick setup screen.
2. Use the adjustment buttons to adjust the response.  
Initial value: 4  
Adjustment range: 1~32 (When the adjustment value is large, the response becomes slow.)

### Hysteresis adjustment

1. Touch the setting button corresponding to the stick whose hysteresis you want to adjust. Adjustment buttons appear on the right-hand side of the stick setup screen.
2. Use the adjustment buttons to adjust the hysteresis.  
Initial value: 1  
Adjustment range: 0~32 (When the adjustment value is large, the hysteresis value becomes large.)

- Touch the [Stick Mode] button at the H/W Setting Menu to call the setup screen shown below.

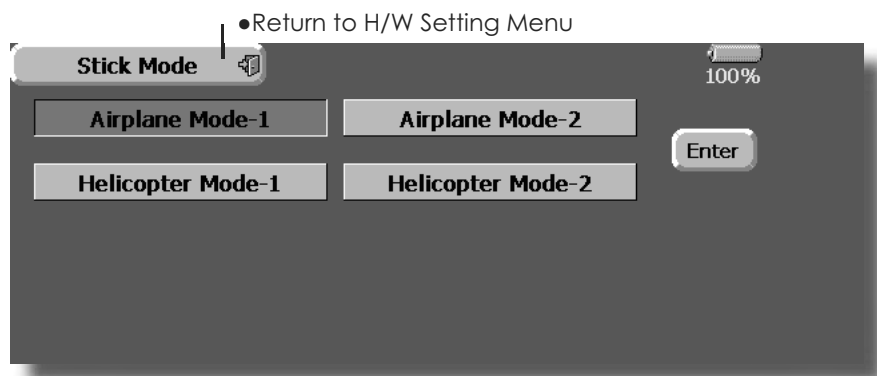

### Stick mode modification

1. Select the button of the stick mode to be used and touch the [Enter] button.  
\*There is a setting button for each Airplane/Helicopter. Touch the button of the mode you want to set.
2. Touch [Yes] on the next screen. The stick mode changes. (To abort the change, press [No].)

\*The stick mode change is applied from newly generated model data. Existing model data is not changed. When the model data was reset (all operation data reset), the data is re-initialized in the stick mode at the time the data was reset.

## Information

Displays the program version, CF card information, and product ID.

The FX-40 system program version information, CF card information (memory size, vacant capacity, number of model data, and number of music files), and product ID are displayed on the Information screen.

\*When the CF card is not inserted, the CF card information is not displayed.

- Touch the [Information] button at the System Menu to call the setup screen shown below.

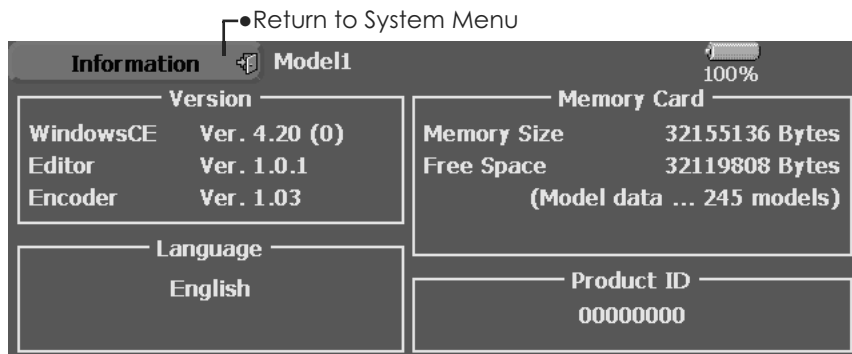

# MODEL BASIC SETTING PROCEDURE

## Airplane/glider basic setting procedure

### 1. Model addition and call

Initial setting assigns 1 model to the FX-40 transmitter. The Model Select function of the Linkage Menu is used to add models and to call models which are already set.



This is convenient when calling a model after its name has been registered. (The data of up to 30 models can be saved to the transmitter. More can also be saved to the accessory CF card.)

The currently called model name is displayed at the top of the screen. Before flying and before changing any settings, always confirm the model name.

When a new model was added, the Model type select screen and Frequency/Modulation mode/Receiver ID setup screen automatically appear. Please be aware that the transmitter will stop transmitting when you change the model.

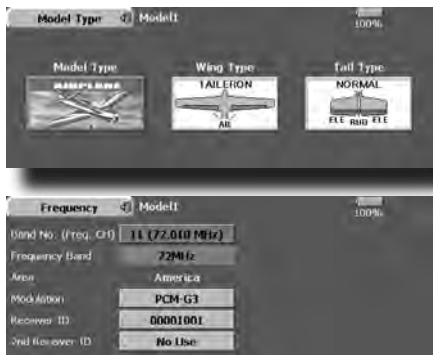

### 2. Model type selection

Select the model type matched to the wing type with the Model Type select function of the Linkage Menu. For an airplane, select the model type from among the 3 types: airplane, glider, and motor glider. When the Wing type select screen is displayed and the wing type is selected when selecting the model type, the Tail type select screen is displayed. Select the tail type matched to the fuselage.

There are 13 wing types and 3 tail types for airplane, glider, and motor glider.

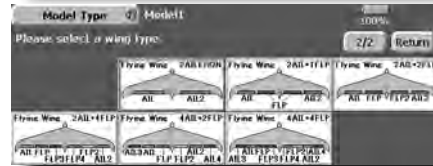
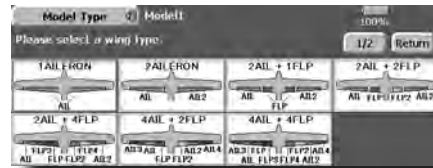

### 3. Fuselage linkage

Link the ailerons, elevators, throttle, rudder, etc. in accordance with the model's instruction manual. For a description of the connection method, see the Receiver and Servos Connection.

**Note: The channel assignment of the FX-40 is different from that of our existing systems. Note that even for the same "airplane model", when the wing type and tail type are different, the channel assignment may be different. (The channel assigned to each function can be checked at the Function menu of the Linkage Menu.)**

Function	Control	Trim	Condition 1	Control	Trim
1 Elevator	J2	T2	Auxiliary6	NULL	NULL
2 Rudder	J4	T4	Auxiliary5	NULL	NULL
3 Throttle	J3	T3	Auxiliary4	NULL	NULL
4 Aileron	J1	T1	Auxiliary3	NULL	NULL
5 Gear	SW-E	NULL	Auxiliary2	NULL	NULL
6 Air Brake	LST	NULL	Auxiliary1	NULL	NULL

- When the direction of the linkage is reversed, adjust the direction with the Reverse function of the Linkage Menu.

Servo Reverse	Function	Setting	Function	Setting	CH	Setting
1 Elevator	NORM	7	Auxiliary6	NORM	DG1	NORM
2 Rudder	NORM	8	Auxiliary5	NORM	DG2	NORM
3 Throttle	NORM	9	Auxiliary4	NORM		
4 Aileron	NORM	10	Auxiliary3	NORM		
5 Gear	NORM	11	Auxiliary2	NORM		
6 Air Brake	NORM	12	Auxiliary1	NORM		

- Connect the throttle linkage so carburetor is open at full trim.
- Adjust the neutral position and rudder angle with the linkage, and fine tune them with the Sub Trim and End Point functions (rudder angle adjustment). To protect the linkage, a limit position can also be set with the End Point function. The End Point function can adjust the amount of up/down and left/right movement, limit, and servo speed of each channel.



#### 4. Throttle cut setting

Throttle cut can be performed with one touch by a switch without changing the throttle trim position.

Set throttle cut with the Throttle Cut function of the Linkage Menu. After activating the throttle cut function and selecting the switch, adjust the throttle position so that the carburetor becomes full open. For safety, the throttle cut function operates the throttle stick in the 1/3 or less (slow side) position.



#### 5. Idle down setting

The idling speed can be lowered with one touch by a switch without changing the throttle trim position. Perform this setting with the Idle Down function of the Linkage Menu. After activating the Idle Down function and selecting the switch, adjust the idle down speed. For safety, the idle down function acts only when the throttle stick is in the 1/3 or less (slow side) position.

\*While the Throttle Cut function is in operation, the Idle Down function does not work.

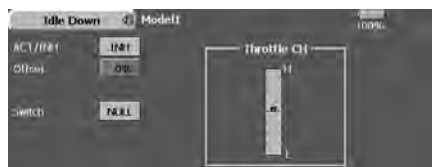

#### 6. AFR (D/R)

AFR function is used to adjust the throw and operation curve of the stick, lever, and switch functions (CH1 to CH12, and V1 to V4) for each flight condition. This is normally used after End Point (ATV) has defined the maximum throw directions (End Point acts on ALL flight condition settings). When mixing is applied from one channel to another channel, both channels can be adjusted at the same time by adjusting the operation rate through the AFR function.

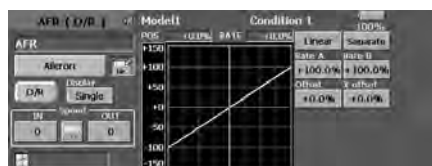

#### 7. Airbrake

This function is used when an air brake is necessary when taking off or diving, etc.

The preset elevators and flaps (camber flap, brake flap) offset amount can be activated by a switch.

The offset amount of the aileron, elevator, and flap servos can be adjusted as needed. Also the speed of the aileron, elevator, and flap servos can be adjusted. (IN side/OUT side) A delay can be set for each condition, and a Cut switch which will turn OFF the delay can be chosen. Trim amounts can be fine-tuned by setting a VR You can also set the Auto Mode, which will link Airbrake to a stick, switch, or dial. A separate stick switch or dial can also be set as the ON/OFF switch.

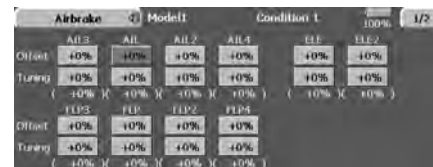

#### 8. Addition of flight conditions

The transmitter can install up to eight flight conditions per model. You can assign all switches including sticks, switches, trim levers and trim switches as flight-condition selection switches. You can also add delayed mixing to these functions in order to avoid sudden changes. Moreover, you can set priority order for flight conditions when you set more than one condition. In addition, you can copy conditions and/or change names of conditions. This command may also be used to define what switches and/or controls are used to activate each flight condition.

The Condition Select function automatically allocates the Condition 1 for each model type. Condition 1 is the default condition, also referred to as Normal, and is the only one active when a new model type is defined. This condition is always on, and remains on until other conditions are activated by switches.

The Condition Delay can be programmed for each channel. The Condition Delay is used to change the servo throw smoothly when switching conditions.



\*When a new condition is added, "Condition1" data is automatically copied.

\*Select the condition switch and set the new condition data in the switch ON state. However, if the group mode (Gr.) was selected in advance, the same data will be input at all the conditions. Select the single mode (Sngl) and adjust the condition you want to change.

#### 9. When tailless wing model selected

Tailless wing elevator operation uses elevator→camber mixing. This function cannot be performed at initial setting.

## Helicopter basic setting procedure

### 1. Model addition and call

Default setting assigns 1 model to the FX-40. To add new models or to call a model already set, use the Model Select function of the Linkage Menu.



This is convenient when calling a model after registering the model names in advance. (The data of up to 30 models can be saved at the transmitter. Data can also be saved to the accessory Data-Pack.)

The currently called model is displayed at the top of the screen. Before flying and before changing any settings, always confirm the model name.

Please be aware that the transmitter will stop transmitting when you change the model.

When a new model is added, the Model Type Select screen and Frequency/Modulation mode/Receiver ID setup screen automatically appear. Change, or check that they match the type, frequency, and receiver type of the model used.

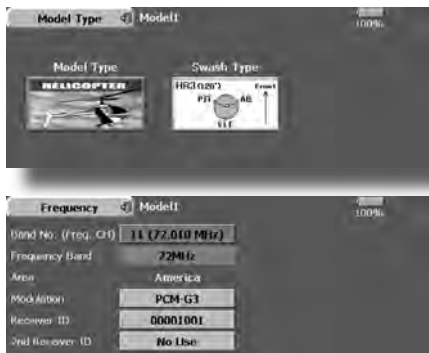

### 2. Model type and swash type selection

When a separate model type is already selected, select helicopter with the Model Type function of the Linkage Menu, and then select the swash type matched to the helicopter.

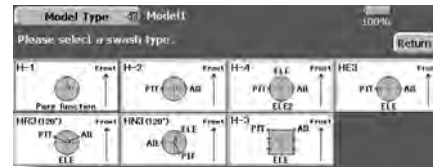

### 3. Flight condition addition

The transmitter can install up to eight flight conditions per model. You can assign all switches including sticks, switches, trim levers and trim switches as flight-condition selection switches. You can also add delayed mixing to these functions in order to avoid sudden changes. Moreover, you can set priority order for flight conditions when you set more than one condition. In addition, you can copy conditions and/or change names of conditions. This command may also be used to define what switches and/or controls are used to activate each flight condition.

The Condition Select function automatically allocates the Condition for each model type. Normal is the default condition, and is the only one active when a new model type is defined. This condition is always on, and remains on until other conditions are activated by switches.

The Condition Delay can be programmed for each channel. The Condition Delay is used to change the servo throw smoothly when switching conditions.



#### (General flight condition setting example)

- Normal: (Use initial setting conditions/operate when switch OFF)  
Use from engine starting to hovering.
- Idle up 1: (Switch setting example: Operate at SW-E center)  
Use in 540° stall turn, loop, rolling stall turn, and other maneuvers.
- Idle up 2: (Switch setting example: Operate at SW-E forward side)  
Use in rolls.
- Throttle hold: (Switch setting example: Operate at SW-G forward side)  
Use in auto rotation.

The priority is throttle hold/idle up 2/idle up 1/normal. Throttle hold has the highest priority.

Add other conditions, as required.

#### 4. Fuselage linkage

Connect the throttle rudder, ailerons, elevators, pitch, and other rudder linkages in accordance with the kit instruction manual. For a description of the connection method, see "Receiver and Servos Connection".

**\*The channel assignment of the FX-40 is different from that of our existing systems. (The channel assigned to each function can be checked at the Function menu of the Linkage Menu.)**

Function	Model I	Normal	VC14
1. Throttle	J2	T2	
2. Rudder	J4	T4	
3. Gyro	NULL	NULL	
4. Aileron	J1	T1	
5. Elevator	J3	T3	
6. Pitch	J2	NULL	
		7. Governor	NULL
		8. Governor2	NULL
		9. Needle	LST
		10. Auxiliary3	NULL
		11. Auxiliary2	NULL
		12. Auxiliary1	NULL

- When the direction of operation of the linkage is reverse, use the Reverse function of the Linkage Menu. Also use the swash AFR function in other than the H-1 mode.

Servo Reverse	Model I	Setting
1. Throttle	NORM	
2. Rudder	NORM	
3. Gyro	NORM	
4. Aileron	NORM	
5. Elevator	NORM	
6. Pitch	NORM	
7. Governor	NORM	
8. Governor2	NORM	
9. Needle	NORM	
10. Auxiliary3	NORM	
11. Auxiliary2	NORM	
12. Auxiliary1	NORM	

Swash	Model I	Swash AFR
Neutral Point	50%	
High Pitch	0%	+50%
Low Pitch	0%	+50%

- Adjust the direction of operation of the gyro. (Gyro side function)
- Connect the throttle linkage so that the carburetor becomes full open at full trim throttle cut is possible.
- Basically, adjust the neutral position and rudder angle at the linkage side and fine tune with the Sub-Trim function and End Point function (rudder angle adjustment). To protect the linkage, a limit position can also be set with the End Point function.

Sub-Trim	Model I	100%
RU	40	40
RU	40	40
RU	40	40
RU	40	40
RU	40	40
RU	40	40
RU	40	40
RU	40	40
RU	40	40
RU	40	40
RU	40	40

End Point (ATV)	Model I	Limit	Travel	100% Speed
1. Throttle	135%	100%	100%	135%
2. Rudder	135%	100%	100%	135%
3. Gyro	135%	100%	100%	135%
4. Aileron	135%	100%	100%	135%
5. Elevator	135%	100%	100%	135%
6. Pitch	135%	100%	100%	135%

- Swash plate correction (Except H-1 mode)  
Operation of the swash plate near the hovering point can be corrected by swash AFR function correction mixing. Use this when pitch, aileron, and elevator operation causes the swash plate to deviate from the normal direction.

Swash Detail	Model I	Swash AFR
Mixing Rate	100%	100%
PIT to AIL	100%	100%
PIT to ELE	100%	100%
AIL to PIT	100%	100%
ELE to AIL	50%	50%
ELE to PIT	50%	50%
Linkage Compensation		
Function Dis.	0%	0%
Aileron	0%	0%
Elevator	0%	0%
Speed Compensation	0	

(Call the Swash setup→Swash details screen.)  
Pitch slow side and high side linkage correction is also possible. Adjust so that pitch operation causes the swash plate to move up and down in the horizontal state.

#### 5. Throttle curve setting

This function adjusts the pitch operation curve in relation to the movement of the throttle stick for each condition.

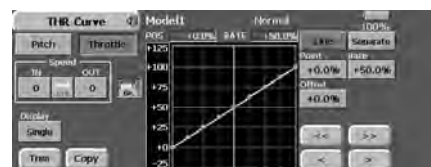

#### (17 points curve)

The pitch curve can be freely selected from linear operation curve to smooth curve, and adjusted to match the curve you want by means of the T14MZ's powerful Curve Edit Function (6 types of curves can be selected). Up to 17 points can be set for linear or curve types. However, when using the 3 points or 5 points specified to create a curve, a simple and smooth curve can be created by selecting the curve type and reducing the number of input points to 3 or 5, and then entering the specified value at the corresponding points that you created.

#### <Setting example>

Call the throttle curve of each condition with the condition select switch.

- Normal curve adjustment  
Normal curve uses Normal (Linear) type and creates a basic pitch curve centered near hovering. This curve is adjusted together with the Throttle Curve (Normal) so that the engine speed is constant and up/down control is easiest.

- Idle up curve adjustment  
The high side pitch curve sets the maximum pitch regardless of the engine load. The low side pitch curve creates a curve matched for aerobatics (loop, roll, 3D, etc.).

Note: When the curve type is changed, the data is reset.

- Throttle hold curve adjustment  
The throttle hold curve is used when performing auto rotation dives.  
Confirm that the rate of the slowest position (0%) of the stick is 0% (initial setting).  
Be sure that when set to high side 100%, the curve of any condition does not exceed 100%.

Example of pitch curve setting:

1. Call the pitch curve of each condition with the condition select switch.  
\*Pitch curve graph display can be switched to pitch angle direct reading display.
  - A. Pitch curve (Normal)  
Make the pitch at hovering approximately +5°~6°. Set the pitch at hovering with the stick position at the 50% point as the standard.  
\*Stability at hovering may be connected to the throttle curve. Adjustment is easy by using the hovering throttle function and hovering pitch function together.
  - B. Pitch curve (Idle up 1)  
The idle up 1 pitch curve function creates a curve matched to airborne flight. Set to -7°~+12° as standard.
  - C. Pitch curve (Idle up 2)  
The high side pitch setting is less than idle up 1. The standard is +8°.
  - D. Pitch curve (Hold)  
At auto rotation, use the maximum pitch at both the high and low sides.  
[Pitch angle setting example]  
Throttle hold: -7°~+12°

## 6. Throttle hold setting

Call the Throttle Hold function from the Model Menu and switch to the throttle hold condition with the condition select switch.



Note: At initial setting, the setting mode is the group mode. Since this function is not used at other conditions, switch to the single mode before setting.

- Setting to the state which activates the function  
The throttle hold function allows setting for throttle cut and switching of the function fixed at the idle position by switch for training. Either one or both functions can be performed.
- Hold position setting  
This function sets the servo operation position at throttle hold. (Throttle cut and idle positions)
- Other settings  
When you want to link operation with stick

manipulation, the Auto mode can be set. When you want to adjust the servo speed, adjust [Speed].

## 7. Pitch to RUD mixing setting

Use this function when you want to suppress the torque generated by the changes in the pitch and speed of the main rotor during pitch operation. Adjust it so that the nose does not swing in the rudder direction. However, when using a heading hold gyro like those shown below, do not use Pitch to RUD mixing.

Note: When using a GY601, GY502, GY401, or other heading hold gyro, this Pitch to RUD mixing should not be used. The reaction torque is corrected at the gyro side. When operating the gyro in the AVCS mode, the mixed signal will cause neutral deviation symptoms and the gyro will not operate normally.

Call the Pitch to RUD mixing function from the Model Menu, and set the curve for each condition. (At initial setting, this function is in the "INH" state. To use it, set it to the "ON" state.)

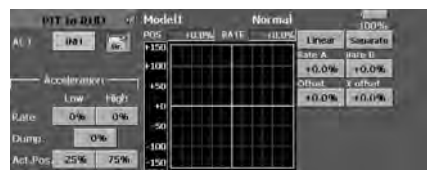

(17 points curve)

Curve setting of up to 17 points is possible. However, in the following setting example, a simple curve can be adjusted by using the [Linear] curve type.

Note: At initial setting, the setting mode is the group mode. In this mode, the same contents are set at in all conditions. When you want to set the selected condition only, switch to the single mode.

### <Setting example>

Call the mixing curve of each condition with the condition select switch.

A. Pitch to RUD mixing curve (Normal)  
Use the hovering system and set this curve to match take off and landing and vertical climb at a constant speed.

\*For this curve, use the initial setting [Linear] curve type and adjust the left and right rates in the [Separate] mode.

B. Pitch to RUD mixing (Idle up 1)  
Use this curve in 540° stall turn, loop, and rolling stall turn, and adjust it so the fuselage is facing straight ahead when heading into the wind.

\*For this curve, [Linear] curve type can be used and the entire curve can be lowered with the [Offset] button.

C. Pitch to RUD mixing (Hold)  
This function is set so that the fuselage is facing straight ahead at straight line auto rotation. The pitch of the tail rotor becomes nearly 0°.

\*For this curve, [Linear] curve type can be used and the entire curve can be lowered with the [Offset] button.

•Other settings

The mixing characteristic at pitch operation can be adjusted. An acceleration (ACLR) function and deceleration (DCLR) function, which temporarily increases and decreases the mixing amount, can be set.

### 8. Swash Mix corrects aileron, elevator and pitch interaction

The swash mix function is used to correct the swash plate in the aileron (roll) direction and elevator (cyclic pitch) corresponding to each operation of each condition.



### 9. Throttle mixing setting

RPM loss caused by swash operation at aileron or elevator operation can be corrected with the Throttle Mix function of the Model Menu. How clockwise and counterclockwise torque is applied when pirouetting can also be corrected.

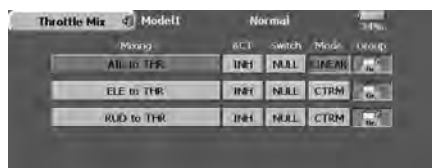

### 10. Gyro sensitivity and mode switching

The gyro sensitivity and mode switching function can be set for each condition.

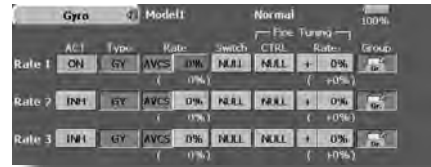

- Normal condition (hovering): Gyro sensitivity maximum
- Idle up 1/Idle up 2/Throttle hold: Gyro sensitivity minimum
- However, at auto rotation of a tail-driven helicopter, this function may not have any affect at high gyro sensitivity.

### 11. Throttle cut setting

Throttle cut provides an easy way to stop the engine, by flipping a switch with the throttle stick at idle. The action is not functional at high throttle to avoid accidental dead sticks. The switch's location and direction must be chosen, as it defaults to NULL.



\*With throttle stick at idle, adjust the cut position until the engine consistently shuts off, but throttle linkage is not binding. When finished, touch the "Throttle Cut" button to exit.

### 12. Other special mixings

- Pitch to Needle mixing  
This mixing is used with engines with a construction which allows needle control during flight (fuel-air mixture adjustment). A needle curve can be set. The needle servo rise characteristics at throttle stick acceleration/deceleration operation can be adjusted. (Acceleration function)
- Fuel mixture function  
This mixing is used in needle adjustment of engines which use a fuel mixture control carburetor.
- Governor mixing  
This mixing is used when a GV-1 (governor) is used. Up to 3 rates (speeds) can be switched for each condition.

## Receiver and servos connection

Connect the receiver and servos in accordance with the connection diagram shown below. Please read the "Precautions" when mounting the receiver and servos. When mounting the receiver and servos to the fuselage, connect the necessary points in accordance with the kit instruction manual.

### Receiver and servos connection diagram

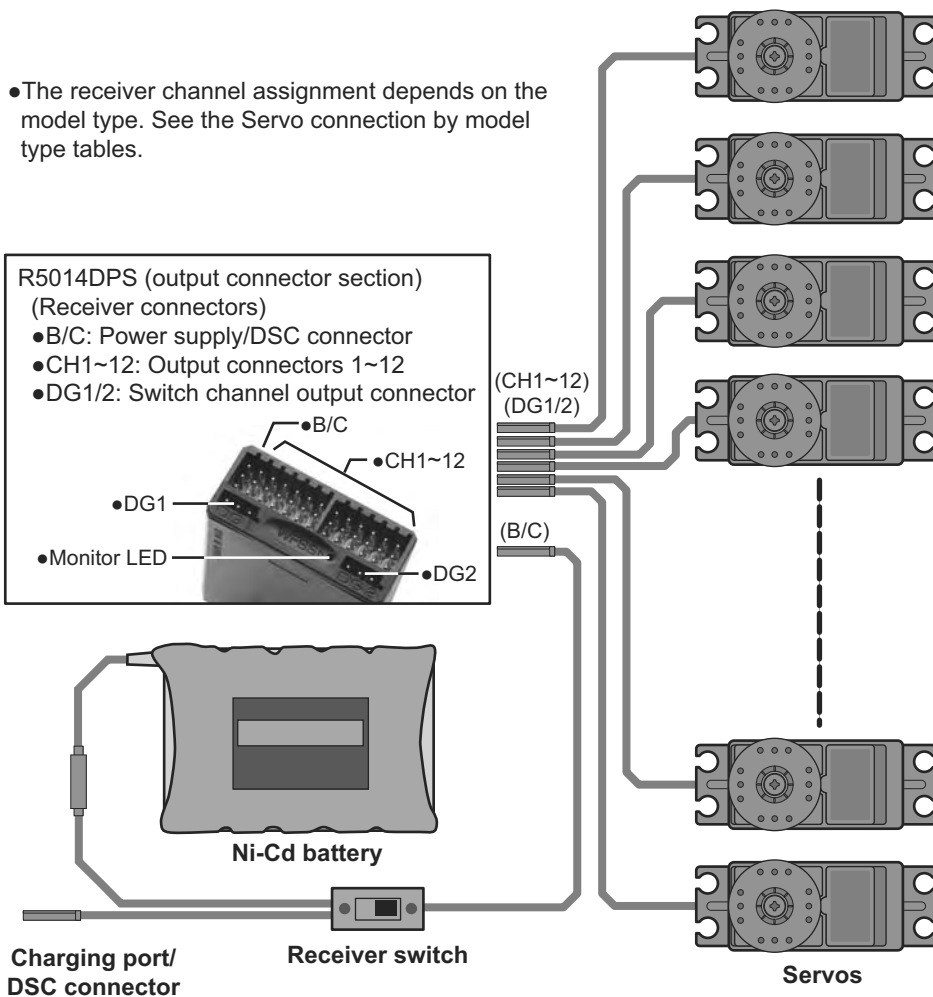

- The Servo connection by model type tables are shown on the following pages. Connect the servos to match the model used.

## Servo connection by model type

The FX-40 transmitter channels are automatically assigned for optimal combination according to the type selected with the Model Type function of the Linkage Menu. The channel assignment (initial setting) for each model type is shown below. Connect the receiver and servos to match the type used.

\*The set channels can be checked at the Function screen of the Linkage Menu. The channel assignments can also be changed. For more information, read the description of the Function menu.

### Airplane/glider/motor glider

#### •Airplane and V tail

RX CH	1AIL			2AIL			2AIL+1FLAP			2AIL+2FLAP		
	Airplane	Glider		Airplane	Glider		Airplane	Glider		Airplane	Glider	
		EP			EP			EP			EP	
1	Elevator	Elevator	Elevator	Elevator	Elevator	Elevator	Elevator	Elevator	Elevator	Elevator	Elevator	Elevator
2	Rudder	Rudder	Rudder	Rudder	Rudder	Rudder	Rudder	Rudder	Rudder	Rudder	Rudder	Rudder
3	Throttle	Motor	AUX1	Throttle	Motor	AUX1	Throttle	Motor	AUX7	Throttle	Motor	AUX6
4	Aileron	Aileron	Aileron	Aileron	Aileron	Aileron	Aileron	Aileron	Aileron	Aileron	Aileron	Aileron
5	Gear	AUX7	AUX7	Aileron2	Aileron2	Aileron2	Aileron2	Aileron2	Aileron2	Aileron2	Aileron2	Aileron2
6	Airbrake	Airbrake	Airbrake	Gear	AUX7	AUX7	Flap	Flap	Flap	Gear	AUX5	AUX5
7	AUX6	AUX6	AUX6	AUX6	AUX6	AUX6	Gear	AUX6	AUX6	Flap	Flap	Flap
8	AUX5	AUX5	AUX5	AUX5	AUX5	AUX5	AUX5	AUX5	AUX5	Flap2	Flap2	Flap2
9	AUX4	AUX4	AUX4	AUX4	AUX4	AUX4	AUX4	AUX4	AUX4	AUX4	AUX4	AUX4
10	AUX3	AUX3	AUX3	AUX3	AUX3	AUX3	AUX3	AUX3	AUX3	AUX3	AUX3	AUX3
11	AUX2	AUX2	AUX2	AUX2	AUX2	AUX2	AUX2	AUX2	AUX2	AUX2	AUX2	AUX2
12	AUX1	AUX1	AUX1	AUX1	AUX1	AUX1	AUX1	AUX1	AUX1	AUX1	AUX1	AUX1
VC1	AUX1	AUX1	AUX1	Camber	Camber	Camber	Camber	Camber	Camber	Camber	Camber	Camber
VC2	AUX1	AUX1	AUX1	AUX1	Butterfly	Butterfly	AUX1	Butterfly	Butterfly	AUX1	Butterfly	Butterfly
VC3	AUX1	AUX1	AUX1	AUX1	AUX1	AUX1	AUX1	AUX1	AUX1	AUX1	AUX1	AUX1
VC4	AUX1	AUX1	AUX1	AUX1	AUX1	AUX1	AUX1	AUX1	AUX1	AUX1	AUX1	AUX1

- When a receiver other than the PCM-G3 type is used, only the shaded part of the table above is valid.
- VC1~4 are virtual channels without receiver output. For more information, see the description of the Function menu of the Linkage Menu.

RX CH	2AIL+4FLAP			4AIL+2FLAP			4AIL+4FLAP		
	Airplane	Glider		Airplane	Glider		Airplane	Glider	
		EP			EP			EP	
1	Elevator	Elevator	Elevator	Elevator	Elevator	Elevator	Elevator	Elevator	Elevator
2	Rudder	Rudder	Rudder	Rudder	Rudder	Rudder	Rudder	Rudder	Rudder
3	Throttle	Motor	AUX4	Throttle	Motor	AUX4	Throttle	Motor	AUX2
4	Aileron	Aileron	Aileron	Aileron	Aileron	Aileron	Aileron	Aileron	Aileron
5	Aileron2	Aileron2	Aileron2	Aileron2	Aileron2	Aileron2	Aileron2	Aileron2	Aileron2
6	Gear	AUX3	AUX3	Gear	AUX3	AUX3	Gear	AUX1	AUX1
7	Flap	Flap	Flap	Aileron3	Aileron3	Aileron3	Aileron3	Aileron3	Aileron3
8	Flap2	Flap2	Flap2	Aileron4	Aileron4	Aileron4	Aileron4	Aileron4	Aileron4
9	Flap3	Flap3	Flap3	Flap1	Flap1	Flap1	Flap1	Flap1	Flap1
10	Flap4	Flap4	Flap4	Flap2	Flap2	Flap2	Flap2	Flap2	Flap2
11	AUX2	AUX2	AUX2	AUX2	AUX2	AUX2	Flap3	Flap3	Flap3
12	AUX1	AUX1	AUX1	AUX1	AUX1	AUX1	Flap4	Flap4	Flap4
VC1	Camber	Camber	Camber	Camber	Camber	Camber	Camber	Camber	Camber
VC2	AUX1	Butterfly	Butterfly	AUX1	Butterfly	Butterfly	AUX1	Butterfly	Butterfly
VC3	AUX1	AUX1	AUX1	AUX1	AUX1	AUX1	AUX1	AUX1	AUX1
VC4	AUX1	AUX1	AUX1	AUX1	AUX1	AUX1	AUX1	AUX1	AUX1

●Ailevator

RX CH	1AIL			2AIL			2AIL+1FLAP			2AIL+2FLAP		
	Airplane	Glider		Airplane	Glider		Airplane	Glider		Airplane	Glider	
		EP			EP			EP			EP	
1	Elevator	Elevator	Elevator	Elevator	Elevator	Elevator	Elevator	Elevator	Elevator	Elevator	Elevator	Elevator
2	Elevator2	Elevator2	Elevator2	Elevator2	Elevator2	Elevator2	Elevator2	Elevator2	Elevator2	Elevator2	Elevator2	Elevator2
3	Rudder	Rudder	Rudder	Rudder	Rudder	Rudder	Rudder	Rudder	Rudder	Rudder	Rudder	Rudder
4	Aileron	Aileron	Aileron	Aileron	Aileron	Aileron	Aileron	Aileron	Aileron	Aileron	Aileron	Aileron
5	Throttle	Motor	AUX7	Aileron2	Aileron2	Aileron2	Aileron2	Aileron2	Aileron2	Aileron2	Aileron2	Aileron2
6	Airbrake	Airbrake	Airbrake	Throttle	Motor	AUX7	Throttle	Motor	AUX6	Throttle	Motor	AUX5
7	Gear	AUX6	AUX6	Gear	AUX6	AUX6	Flap	Flap	Flap	Flap	Flap	Flap
8	AUX5	AUX5	AUX5	AUX5	AUX5	AUX5	Gear	AUX5	AUX5	Flap2	Flap2	Flap2
9	AUX4	AUX4	AUX4	AUX4	AUX4	AUX4	AUX4	AUX4	AUX4	Gear	AUX4	AUX4
10	AUX3	AUX3	AUX3	AUX3	AUX3	AUX3	AUX3	AUX3	AUX3	AUX3	AUX3	AUX3
11	AUX2	AUX2	AUX2	AUX2	AUX2	AUX2	AUX2	AUX2	AUX2	AUX2	AUX2	AUX2
12	AUX1	AUX1	AUX1	AUX1	AUX1	AUX1	AUX1	AUX1	AUX1	AUX1	AUX1	AUX1
VC1	AUX1	AUX1	AUX1	Camber	Camber	Camber	Camber	Camber	Camber	Camber	Camber	Camber
VC2	AUX1	AUX1	AUX1	AUX1	Butterfly	Butterfly	AUX1	Butterfly	Butterfly	AUX1	Butterfly	Butterfly
VC3	AUX1	AUX1	AUX1	AUX1	AUX1	AUX1	AUX1	AUX1	AUX1	AUX1	AUX1	AUX1
VC4	AUX1	AUX1	AUX1	AUX1	AUX1	AUX1	AUX1	AUX1	AUX1	AUX1	AUX1	AUX1

- When a receiver other than the PCM-G3 type is used, only the shaded part of the table above is valid.
- VC1~4 are virtual channels without a receiver output. For more information, see the description of the Function menu of the Linkage Menu.

RX CH	2AIL+4FLAP			4AIL+2FLAP			4AIL+4FLAP		
	Airplane	Glider		Airplane	Glider		Airplane	Glider	
		EP			EP			EP	
1	Elevator	Elevator	Elevator	Elevator	Elevator	Elevator	Elevator	Elevator	Elevator
2	Elevator2	Elevator2	Elevator2	Elevator2	Elevator2	Elevator2	Elevator2	Elevator2	Elevator2
3	Rudder	Rudder	Rudder	Rudder	Rudder	Rudder	Rudder	Rudder	Rudder
4	Aileron	Aileron	Aileron	Aileron	Aileron	Aileron	Aileron	Aileron	Aileron
5	Aileron2	Aileron2	Aileron2	Aileron2	Aileron2	Aileron2	Aileron2	Aileron2	Aileron2
6	Throttle	Motor	AUX7	Throttle	Motor	AUX3	Throttle	Motor	AUX1
7	Flap	Flap	Flap	Aileron3	Aileron3	Aileron3	Aileron3	Aileron3	Aileron3
8	Flap2	Flap2	Flap2	Aileron4	Aileron4	Aileron4	Aileron4	Aileron4	Aileron4
9	Flap3	Flap3	Flap3	Flap1	Flap1	Flap1	Flap1	Flap1	Flap1
10	Flap4	Flap4	Flap4	Flap2	Flap2	Flap2	Flap2	Flap2	Flap2
11	Gear	AUX2	AUX2	Gear	AUX2	AUX2	Flap3	Flap3	Flap3
12	AUX1	AUX1	AUX1	AUX1	AUX1	AUX1	Flap4	Flap4	Flap4
VC1	Camber	Camber	Camber	Camber	Camber	Camber	Camber	Camber	Camber
VC2	AUX1	Butterfly	Butterfly	AUX1	Butterfly	Butterfly	AUX1	Butterfly	Butterfly
VC3	AUX1	AUX1	AUX1	AUX1	AUX1	AUX1	AUX1	AUX1	AUX1
VC4	AUX1	AUX1	AUX1	AUX1	AUX1	AUX1	AUX1	AUX1	AUX1



•Tailless wing

RX CH	2AIL			2AIL+1FLAP			2AIL+2FLAP		
	Airplane	Glider		Airplane	Glider		Airplane	Glider	
		EP			EP			EP	
1	Rudder	Rudder	Rudder	Rudder	Rudder	Rudder	Rudder	Rudder	Rudder
2	Rudder2	Rudder2	Rudder2	Rudder2	Rudder2	Rudder2	Rudder2	Rudder2	Rudder2
3	Throttle	Motor	AUX1	Throttle	Motor	AUX7	Throttle	Motor	AUX6
4	Aileron	Aileron	Aileron	Aileron	Aileron	Aileron	Aileron	Aileron	Aileron
5	Aileron2	Aileron2	Aileron2	Aileron2	Aileron2	Aileron2	Aileron2	Aileron2	Aileron2
6	Gear	AUX7	AUX7	Flap	Flap	Flap	Gear	AUX5	AUX5
7	AUX6	AUX6	AUX6	Gear	AUX6	AUX6	Flap	Flap	Flap
8	AUX5	AUX5	AUX5	AUX5	AUX5	AUX5	Flap2	Flap2	Flap2
9	AUX4	AUX4	AUX4	AUX4	AUX4	AUX4	AUX4	AUX4	AUX4
10	AUX3	AUX3	AUX3	AUX3	AUX3	AUX3	AUX3	AUX3	AUX3
11	AUX2	AUX2	AUX2	AUX2	AUX2	AUX2	AUX2	AUX2	AUX2
12	AUX1	AUX1	AUX1	AUX1	AUX1	AUX1	AUX1	AUX1	AUX1
VC1	Elevator	Elevator	Elevator	Elevator	Elevator	Elevator	Elevator	Elevator	Elevator
VC2	AUX1	AUX1	AUX1	Camber	Camber	Camber	Camber	Camber	Camber
VC3	AUX1	AUX1	AUX1	AUX1	Butterfly	Butterfly	AUX1	Butterfly	Butterfly
VC4	AUX1	AUX1	AUX1	AUX1	AUX1	AUX1	AUX1	AUX1	AUX1

- When a receiver other than the PCM-G3 type is used, only the shaded part of the table above is valid.
- VC1~4 are virtual channels without a receiver output. For more information, see the description of the Function menu of the Linkage Menu.

RX CH	2AIL+4FLAP			4AIL+2FLAP			4AIL+4FLAP		
	Airplane	Glider		Airplane	Glider		Airplane	Glider	
		EP			EP			EP	
1	Rudder	Rudder	Rudder	Rudder	Rudder	Rudder	Rudder	Rudder	Rudder
2	Rudder2	Rudder2	Rudder2	Rudder2	Rudder2	Rudder2	Rudder2	Rudder2	Rudder2
3	Throttle	Motor	AUX4	Throttle	Motor	AUX4	Throttle	Motor	AUX2
4	Aileron	Aileron	Aileron	Aileron	Aileron	Aileron	Aileron	Aileron	Aileron
5	Aileron2	Aileron2	Aileron2	Aileron2	Aileron2	Aileron2	Aileron2	Aileron2	Aileron2
6	Gear	AUX3	AUX3	Gear	AUX3	AUX3	Gear	AUX1	AUX1
7	Flap	Flap	Flap	Aileron3	Aileron3	Aileron3	Aileron3	Aileron3	Aileron3
8	Flap2	Flap2	Flap2	Aileron4	Aileron4	Aileron4	Aileron4	Aileron4	Aileron4
9	Flap3	Flap3	Flap3	Flap1	Flap1	Flap1	Flap1	Flap1	Flap1
10	Flap4	Flap4	Flap4	Flap2	Flap2	Flap2	Flap2	Flap2	Flap2
11	AUX2	AUX2	AUX2	AUX2	AUX2	AUX2	Flap3	Flap3	Flap3
12	AUX1	AUX1	AUX1	AUX1	AUX1	AUX1	Flap4	Flap4	Flap4
VC1	Elevator	Elevator	Elevator	Elevator	Elevator	Elevator	Elevator	Elevator	Elevator
VC2	Camber	Camber	Camber	Camber	Camber	Camber	Camber	Camber	Camber
VC3	AUX1	Butterfly	Butterfly	AUX1	Butterfly	Butterfly	AUX1	Butterfly	Butterfly
VC4	AUX1	AUX1	AUX1	AUX1	AUX1	AUX1	AUX1	AUX1	AUX1

## Helicopter

CH	H-4 Swash	All Other
1	Throttle	Throttle
2	Rudder	Rudder
3	Aileron	Gyro
4	Elevator 1	Aileron
5	Pitch	Elevator
6	Elevator 2	Pitch
7	Gyro	Governor 1
8	Governor 1	Governor 2
9	Governor 2	Needle
10	Needle	AUX3
11	AUX2	AUX2
12	AUX1	AUX1
VC1	AUX1	AUX1
VC2	AUX1	AUX1
VC3	AUX1	AUX1
VC4	AUX1	AUX1

- When a receiver other than the PCM-G3 type is used, only the shaded part of the table at the left is valid.
- VC1~4 are virtual channels with no receiver output. For more information, see the description of the Function menu of the Linkage Menu.

## FUNCTIONS OF LINKAGE MENU

The Linkage Menu is made up of functions which perform model addition, model type selection, frequency setting, end point setting, and other basic settings.

The functions which can be selected depend on the model type. A typical menu screen is shown below.

- When a button in the Linkage Menu of the Home screen is touched, the menu shown below is called. Touch the button of the function you want to set.

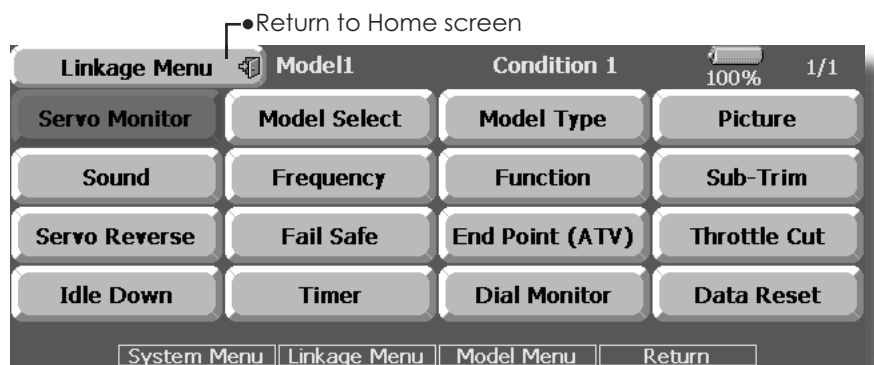

(The display screen is an example. The screen depends on the model type.)

### Linkage Menu functions table

- [Servo Monitor]: Displays the servo test and operation position
- [Model Select]: Model addition, call, deletion, copy, model name setting
- [Model Type]: Model type, wing type, tail type
- [Picture]: Picture selection for each model
- [Sound]: Sound recording and playback
- [Frequency]: Frequency selection, modulation mode selection, receiver ID setting
- [Function]: Channel assignment of each function can be changed
- [Sub-Trim]: Adjusts the neutral position of each servo
- [Servo Reverse]: Servo direction reversal
- [Fail Safe]: Fail safe function and battery fail safe function setting
- [End Point (ATV)]: Servo basic rudder adjustment and limit setting
- [Throttle Cut]: Stops the engine safely and easily (airplane and helicopter only)
- [Idle Down]: Lowers the idle speed of the engine (airplane and helicopter only)
- [Swash]: Swash AFR and linkage correction function (helicopter only)
- [Timer]: Timer setting and lap time display
- [Dial Monitor]: Dial, sliding lever, and digital trim position display
- [Data Reset]: Model memory set data reset (by item)

## Servo Monitor Servo Test & Graph Display / Displays servo positions.

This is used for testing servo movement. Touch “Moving Test” (repetition mode) or “Neutral Test” (fixed position mode) depending on which one shows on the screen. To get from one to the other, simply touch the field again, and you will

move from “Moving Test” to “Neutral Test” automatically. Next touch the “Test” on/off button to start testing your servos. The “Neutral test” is good for finding the neutral position of a servo horn.

- Touch the [Servo Monitor] button in the Linkage Menu to call the setup screen shown below.

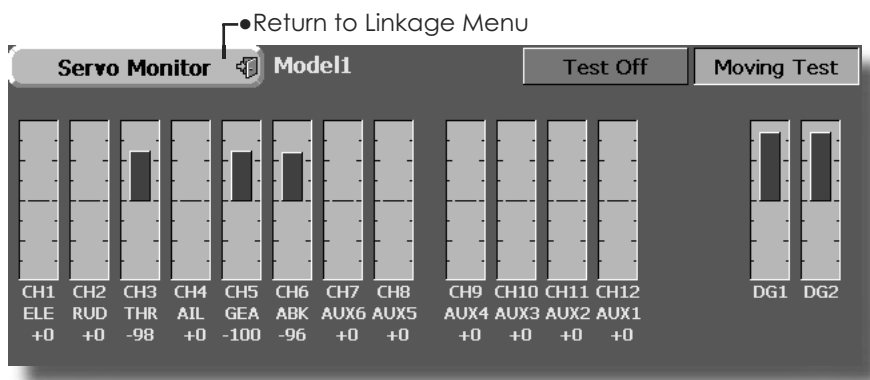

### Servo test operation

1. Select a test mode ([Moving] or [Neutral]).  
[Repeat]: Each servo repeats operation.  
[Neutral]: Each servo is locked in the neutral position.
2. When the [Test Off] button is touched, testing begins in the selected mode.

## Model Select

The Model Selection function performs model addition, call, deletion, copy, and model name setting.

This function is used to load the settings of the desired model into the FX-40's memory.

The settings may be selected from either the transmitter's built-in memory or a Data-Pack CFDP32M (Compact Flash card; 32MB). Remember that up to 30 model memories are available in the transmitter; these may be stored in the CFDP32M card.

The name of the model stored in the transmitter and the Data-Pack may be changed. This can be very useful to tell different models settings apart. Each model name

can be as long as 32 characters, and the model name always appears in the display screen.

The Copy function is used to copy one set of model data into a second memory within the transmitter and the Data-Pack. It may be used for getting a head-start on setting up models with almost the same settings (only differences need to be modified, instead of entering the complete model from scratch). Also, this function may be used to make a backup copy of a model setup before any changes are made.

- Touch the [Model Select] button in the Linkage Menu to call the setup screen shown below.

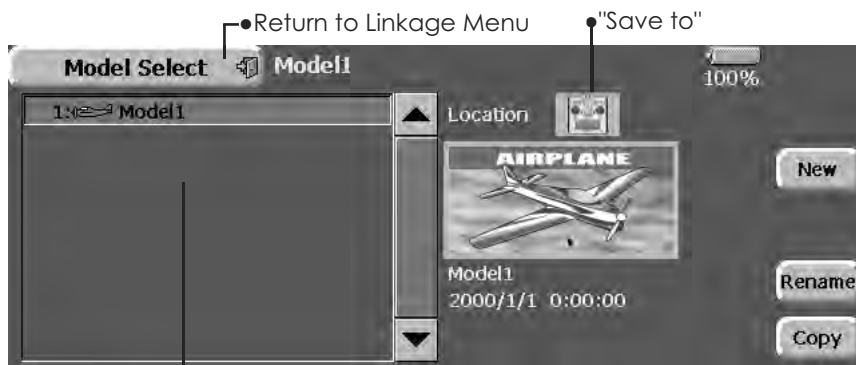

(Model list)

(The display screen is an example. The screen depends on the model type.)

### Model call

1. Touch the "Save to" icon, and select the location to which the desired model is to be saved.  
Transmitter icon: Transmitter memory  
Data pack icon: CF card
2. Touch the desired model in the model list.
3. Touch the [Select] button.
4. Touch [Yes] to call the model. (When you want to cancel model call, press [No].)

### Model addition

1. Touch the [New] button.
2. Touch [Yes] to add the model. (When you want to cancel model addition, touch [No].)  
\*When a new model is added, the Model Type screen and Frequency screen are automatically displayed. Check or change the model and frequency. If there are no changes, touch the Model Type and Frequency icons.  
\*The added model is displayed in the model list.

### Model deletion

1. Touch the "Save to" icon or the model you want to delete in the model list. (The model currently selected cannot be deleted.)
2. Touch the [Delete] button.
3. Touch [Yes]. (When you want to stop model deletion, touch [No].)

### Model name change

1. Select the model by touching the "Save to" icon or the desired model in the model list.
2. When [Change Name] is touched, a keyboard appears on the screen.
3. Enter the model name from this keyboard.  
\*Up to 32 characters can be input at the model name.  
Japanese language input is also possible.  
(For a detailed description of the input method, see "User Name Registration/Character Input Method" of the Basic Operation section.)

### Model copy

1. Touch the [Copy] button to call the Copy screen.
2. Touch the "Source" button and select the model to be copied.
3. Touch the "Destination" button and select the copy storage destination. (Transmitter or CF card)
4. Touch the center [Copy] button.
5. When [Yes] is touched, copying is executed. (When you want to cancel copying, touch [No].)  
\*If there is no model of the same name at the copy destination, the name of the copy source is saved. If there is a model of the same name, a number is appended to the end of the model name and the model is copied. Change the name later.

## Model Type

This function selects the model type from among airplane, helicopter, and glider.

Seven types of main wings and three types of tail wings are available for airplanes. Seven swash types are available for helicopters. Seven types of main wings and three types of tail wings are available for gliders. Functions and mixing functions necessary for each model type are set in advance at the factory.

Note: The Model Type function automatically selects the appropriate output channels, control functions, and mixing functions for the chosen model type. When the Model Type Selection command is accessed, all of the data in the active memory is cleared. Be sure that you don't mind losing this data, or back it up to another memory using the copying functions.

- Touch the [Model Type] button in the Linkage Menu to call the setup screen shown below.

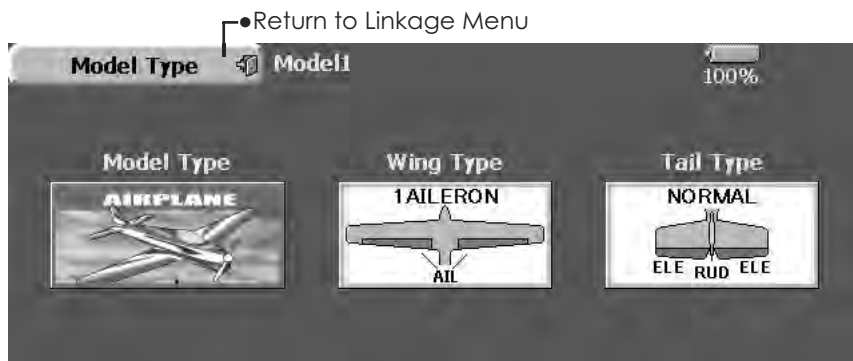

(The display screen is an example. The screen depends on the model type.)

### Model type selection

1. Call the Type select screen by touching the model type, wing, tail, swash type, or other type button.
2. Select the type you want to set, and execute type selection by touching [Yes] at the confirmation screen. (When you want to cancel model type selection, touch [No].)

● Model type selection

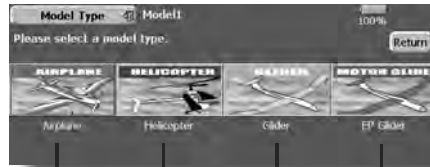

**Model type**  
Select the model type from among airplane, helicopter, glider, and motor glider.

(Airplane, glider)

(Helicopter)

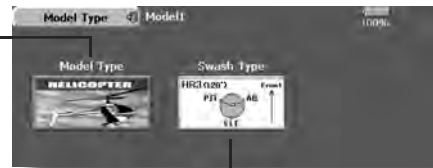

● Wing type selection (1/2)

● Swash type selection

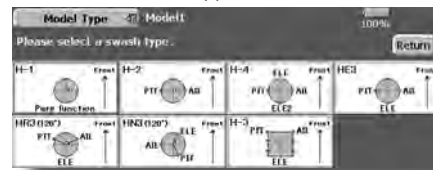
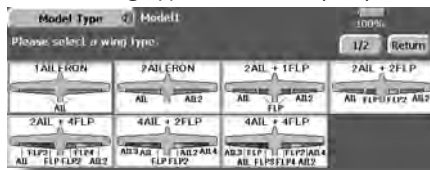

● Wing type selection (2/2)

**Helicopter swash type**  
Select from among H-1, H-2, H-4, HE3, HN3, and H-3.

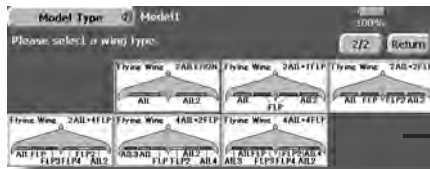

● Rudder type selection



● Tail type selection



**Wing type (1/2) (Normal)**  
Select from among :  
1 aileron, 2 ailerons, 2 ailerons + 1 flap,  
2 ailerons + 2 flaps, 2 ailerons + 4flaps,  
4 ailerons + 2 flaps, 4 ailerons + 4 flaps.

**Wing type (2/2) (Tailless wing)**  
Selection from among:  
2 ailerons, 2 ailerons + 1 flap,  
2 ailerons + 2 flaps, 2 ailerons + 4 flaps,  
4 ailerons + 2 flaps, 4 ailerons + 4 flaps.  
\*For tailless wing, the rudder type can be selected from normal rudder and winglet.

**Tail type**  
Select from normal, V tail, and elevator.

## Picture

A picture can be pasted for each model. (Simplifies identification of the model data during screen operation.)

A photograph of the model taken with a digital camera or other file can be pasted as the screen display data for each model. This is convenient in identifying models with the same model name.

\*The picture files which can be displayed on the screen are size 168 x 80 pixels, file type .bmp (bit map picture) files. If a file larger than this is pasted, the top left-hand side of the picture is displayed.

\*Paste the picture after saving the picture data from your PC to the accessory CF card and inserting the CF card into the transmitter.

When a picture is pasted, it is displayed as the following screen image:

- Model Select screen
- Home screen
- Startup screen

- Touch the [Picture] button in the Linkage Menu to call the setup screen shown below.

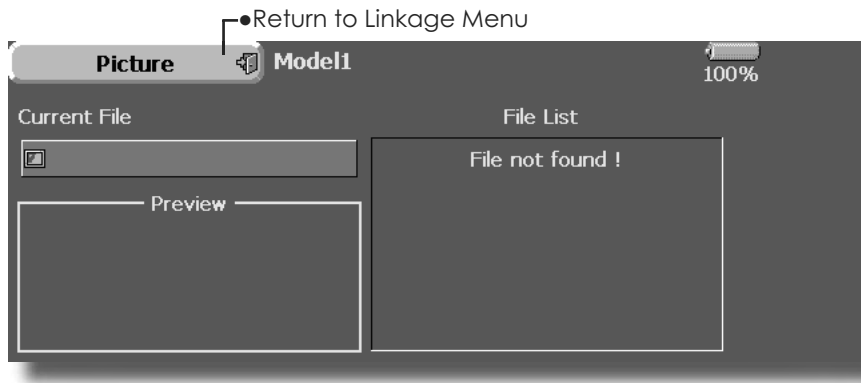

### Pasting of picture

\*Picture data is pasted to the model memory currently in use.

1. Select the picture from the file list by touching the desired picture data.  
\*Before selection, touch the scroll button at the top or bottom of the file list and confirm the contents of the picture files saved on the CF card at the preview screen.
2. To paste the picture, touch [Yes]. (When you want to cancel pasting, touch [No].)

### [Important]

Before reading data from the PC, insert the CF card into the transmitter and turn on the power. The following folders are automatically written. To read a file from the PC, copy the file to a folder by file type.

- BMP: Picture file
- WAV: Audio file
- WMA: Music file
- MODEL: Model data



## Sound

Sound recording and playback.

Sounds recorded with the microphone built into the transmitter and audio files (.wav) saved on the CF card from the PC can be played back when the power switch is turned on and off or by preset switch.

\*The recording time from the microphone is up to 3 seconds/recording. Twenty-four audio files can be saved.

\*When recording, insert the CF card into the transmitter.

\*The only audio file type which can be recorded is .wav. Only the sounds recorded with the built-in microphone or an audio file saved from your PC to the data pack can be played back.

Setup screens No. 3 to 24 can be individually assigned to audio file switches, etc. The playback

files can be switched each time the same switch is operated. This can be used when playing back the name of maneuvers, etc.

[Sound starting]

No. 1: When transmitter power switch turned on

No. 2: When transmitter power switch turned off

No. 3~24: Switch can be set.

### [Important]

Before reading data from a PC, insert the CF card into the transmitter and turn on the power. The following folders are automatically written. When reading a file from the PC, copy it to a holder by file type.

- BMP: Picture file
- WAV: Audio file
- WMA: Music file
- MODEL: Model data

- Touch the [Sound] button in the Linkage Menu to call the setup screen shown below.

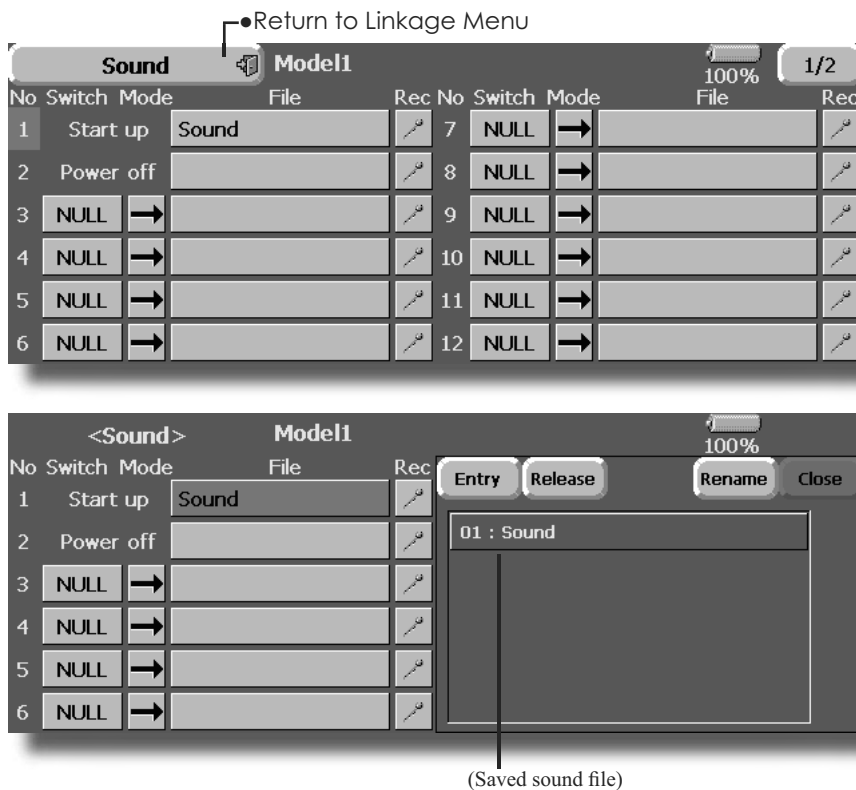

### Voice Recording

1. Touch any REC button to call up the SOUND RECORDER screen.
2. Touch the REC button to start recording. (Recording time: 3 seconds)
3. Record your voice as you are facing the transmitter's microphone.
4. To finish, press "CLOSE". (The voice file is stored in the Data-Pack automatically.)

Also sound files created by your PC may be played back by assigned switches. (File types; .wav file only)

\*You can only assign a sound data stored from your PC to a Data-Pack.

### Assignment of audio files to switches

\*Audio files can be saved to CF card beforehand.

1. Touch the file button of the No. you want to set. A list of the files stored on the CF card is displayed.
2. Select the audio file you want to play back from the list of audio files.

\*Since the audio files are played back when the audio file names in the list are touched, the file contents can be checked before assignment.

3. Touch the [File] button to assign the files.
4. (Switches are also selected for No. 3~24.)  
Touch the [NULL] button to call the Switch select screen.

5. Select the switch and its ON direction at the Switch select screen.  
(For a detailed description of the selection method, see "Switch setting method" at the back of this manual.)

No	Switch	Mode	File	Rec No	Switch	Mode	File	Rec
1	Start up			7				
2	Power off			8				
3	SW-G	→		9				
4		→		10				
5		→		11				
6		→		12				

#### Sequentially playing back registered file each time operated by 1 switch

This is used when calling the order of maneuvers, etc.

[Setting method]

1. After selecting the switch, press the [→] button. The button display thereafter is switched as shown in the screen above.
2. Assign the audio files in the order in which you want to play them back.

The audio files are played back each time the switch selected by the above setting is turned on.

## Frequency

Frequency/Band setting, modulation mode setting, receiver ID code setting.

### Frequency setting

The FX-40 transmitter uses a synthesizer system. Its frequency can be changed within the range of the frequency band of the module used.

The frequency of the R5014DPS receiver is set from the transmitter. Use a receiver matched to the frequency band of the transmitter.

### Receiver ID code

When the R5014DPS receiver (PCM-G3 receiver) is used, the ID code located on the back of the receiver case must be entered.

\*When two receivers are used with a large model, etc., enter the 2nd receiver ID also.

- Touch the [Frequency] button in the Linkage Menu to call the setup screen shown below.

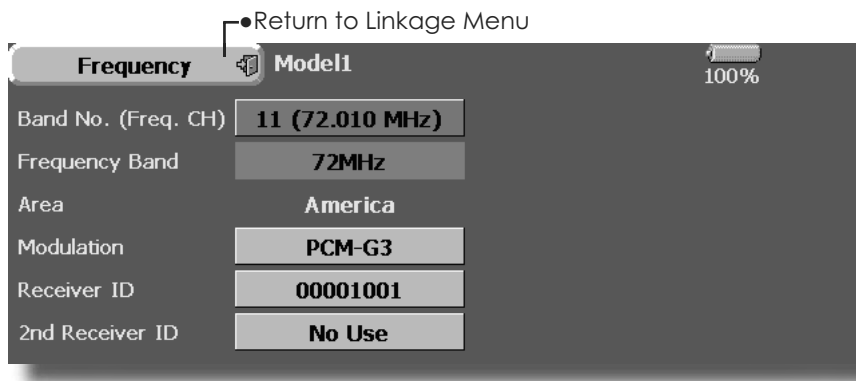

### Frequency switching method

For a description of the frequency switching and ID setting methods, refer to the procedure given in the Basic Operation section.

### Modulation mode change

1. Touch the Modulation Mode button to call the selection screen, and then touch the button of the type of modulation used.
2. Touch the [Enter] button to switch the mode.

\*When switching from the PCM-G3 mode to another mode, the mode cannot be switched if the number of channels is insufficient due to the wing type used.

(PPM modulation)

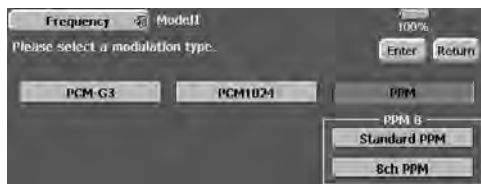

The additional dialog box appears when set the PPM modulation. Push the upper side button to select the PPM polarity. The Standard PPM corresponds to FUTABA

### Modulation mode selection

With the FX-40, 3 modulation modes (PCM-G3/PCM1024/PPM (FM)) can be selected. Select the modulation mode matched to the type of receiver used.

[PCM1024 10ch mode]

The DG2 button is added on the function menu at the PCM1024 mode.

(Caution: The current 9ch receiver must be modified at the servicing department to effective the 10th channel.)

receivers. Push lower side button to select the PPM channels. There are 3 kinds of selections, 8ch PPM, 12ch PPM (N 1.5), 12ch PPM (N 1.3). N means neutral pulse width.

### Receiver ID code input

1. Touch the receiver ID No. on the screen. The receiver ID setup screen is displayed. Input the 8-digit ID number displayed on the back case of the receiver.
2. If the ID number is correct, touch the [Enter] button. To correct the number, use the [BS] button and change the number to the correct ID code.

\*Once the ID code is set, it does not have to be set again as long as the receiver is not changed.

### ! WARNING

- ! When flying after frequency change, emit radio waves only after verifying the frequency.

\*Also change the frequency clip. Emitting radio waves without verification is extremely dangerous.

## Function

Channel assignment of each function can be changed.

When you select model and wing (swash) types, you will find that the optimized combinations of servo output channels and functions have been already preset. If you would like, on the function-setting screen of the linkage menu, you can freely change combinations of servo output channels, functions (aileron, elevator, etc), and input controllers (sticks, switches, trim levers and trim switches). You can also assign the same function to multiple servo output channels such as assigning elevator function to CH2 and CH3.

### DG1, DG2 (switch channels)

These two channels can be used as switch channels. You can freely change combinations between servo output channels and input controllers (sticks, switches, trim levers and trim switches).

### VC1~VC4 (virtual channels)

These four channels can be set as virtual functions that do not have servo output channels. You can freely change combinations between functions (aileron, elevator, etc) and input controllers (sticks, switches, trim levers and trim switches).

Note: In PCMG3 mode, combinations of three channels such as CH 1 through CH 3, CH 4 through CH 6, CH 7 through CH 9 and CH 10 through CH 12 work simultaneously. Futaba recommends that you use the standard optimized default combinations of channels and functions in order to minimize servo delay when you use multiple servos to control models such as swash mode helicopters and dual elevator airplanes or flaperon airplanes.

### Servo Output Channels

For PCMG3 mode, you can set twelve linear channels and two digital channels. For PCM1024 mode, you can set eight linear channels and one digital channel. For PPM mode, you can set only eight linear channels.

- Touch the [Function] button in the Linkage Menu to call the setup screen shown below.

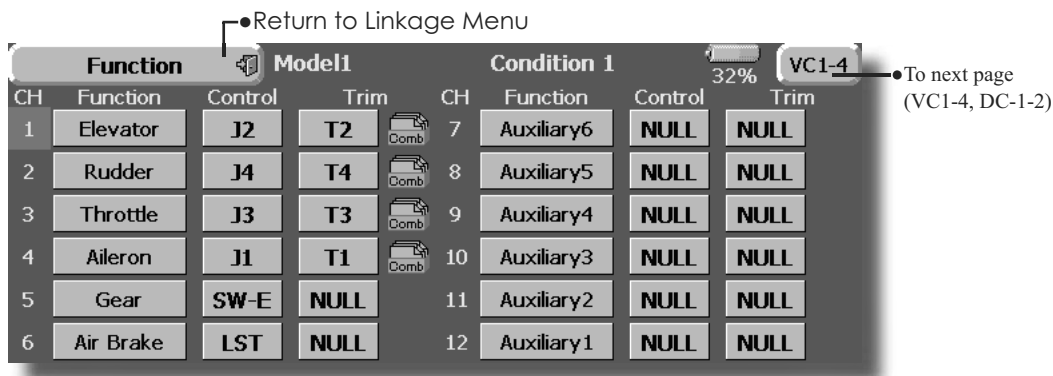

(The display screen is an example. The screen depends on the model type.)

### Function change

1. Touch the function button of the channel you want to change to call the function list.
2. Select the function you want to change.
3. Touch [Yes]. The display returns to the original screen. (When you want to cancel function change, touch [No].)

\*Multiple channels can be assigned to 1 function.

### Operation control change

1. Touch the control button of the channel you want to change. A Control select screen (stick, switch, knob, trim lever, etc.) is displayed.
2. Select the control you want to operate.
3. Touch [Close]. The display returns to the preceding screen.

\*The same control can be assigned to multiple channels.

## Trim change

1. Touch the Trim button to call the Trim setup screen.
2. The following items can be set at the Trim setup screen.
  - Hardware setting (Selection of switch, etc. which controls trim) (The select screen is called by touching the [H/W Select] button.)
  - Rate setting
  - Operation step setting
  - Trim mode setting  
Normal mode: Normal trim (parallel shift trim) operation

ATL mode: ATL operation mode. Reverse is also possible.

CTRM mode: Maximum change near center by center trim operation

- Separate/combination mode: Trim data are set to flight conditions  
Separate mode: Trim adjustment for each flight condition

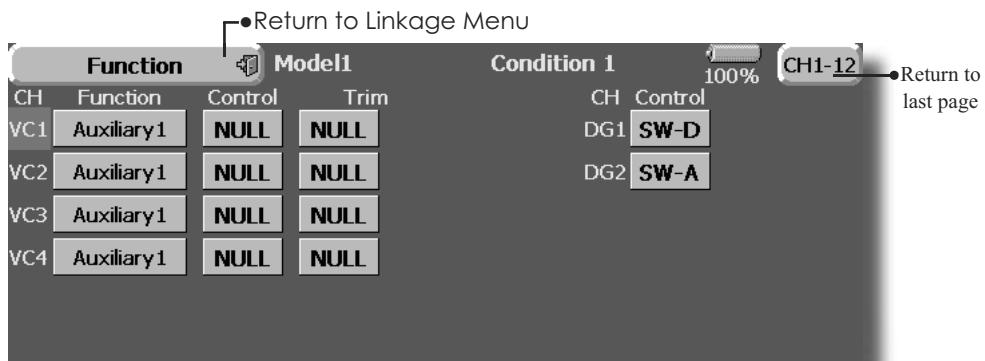

(The display screen is an example. The screen depends on the model type.)

## Sub-Trim Setting of neutral position of each servo.

The Sub-Trim function is used to set the servo neutral position, and may be used to make fine adjustments to the control surface after linkages and pushrods are hooked up. When you begin to set up a model, be sure that the digital trims are set to their center position.

- Touch the [Sub Trim] button in the Linkage Menu to call the setup screen shown below.

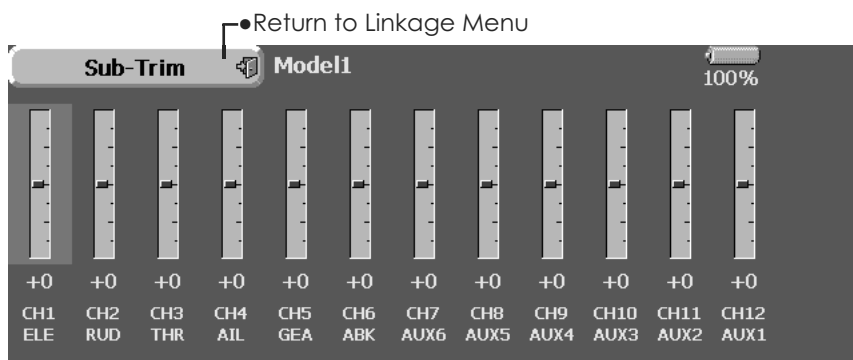

(The display screen is an example. The screen depends on the model type.)

### Sub trim adjustment

1. Touch the trim display part of the channel you want to adjust.  
Adjustment buttons appears on the Sub Trim menu screen.
2. Use the adjustment buttons to adjust the sub trim.
  - Initial value: 0
  - Adjustment range: -240~+240 (steps)

\*See above
3. Repeat this step for each channel.

## Servo Reverse

Use to reverse the throw direction.

Servo Reverse changes the direction of an individual servo's response to a control stick movement.

For CCPM helicopters, be sure to read the section on Swash AFR before reversing any servos. With CCPM helicopters, always complete your servo reversing prior to any other programming. If you use pre-built Airplane/Sailplane functions

that control multiple servos, it may be confusing to tell whether the servo needs to be reversed or a setting in the function needs to be reversed. See the instructions for each specialized function for further details. Always check servo direction prior to every flight as an additional precaution to confirm proper model memory, hook ups, and radio function.

- Touch the [Servo Reverse] button in the Linkage Menu to call the setup screen shown below.

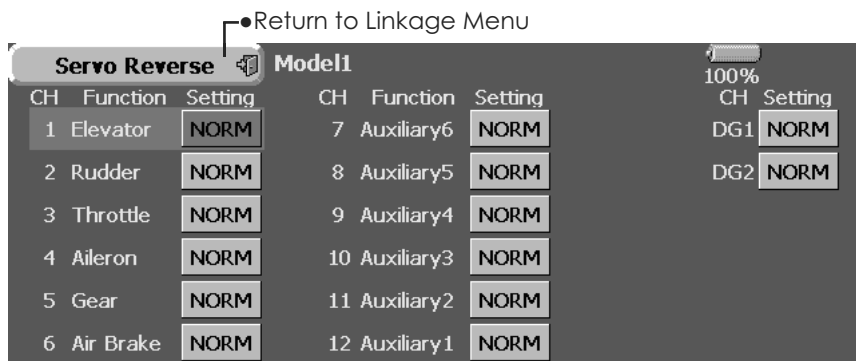

(The display screen is an example. The screen depends on the model type.)

### Servo reversing procedure

After setting up a new model, be sure to define all special menus. Be sure that all servos are plugged into the proper receiver channels. Now, determine whether you need to reverse any channels by moving each stick and observing the corresponding movement in the model's controls.

1. Touch the desired channel's Setting button to choose the proper direction for the servo
  2. Touch " Yes" in the next screen.
  3. Repeat for each servo needing reversal.
- When done, touch " Servo Reverse" to return to the Linkage Menu.

## Fail Safe

Sets the servos operating position when transmitter signals can no longer be received or when the receiver battery voltage drops.

The Failsafe function may be used to set up positions that the servos move to in the case of radio interference.

This function only works with G3 or PCM receivers (FM receivers do not have failsafe capability).

When the receiver battery voltage drops, the servo can be moved to a preset position. (Battery fail safe function) A battery fail safe function reset switch can be set. (Initial setting: Throttle stick maximum slow side)

You may set either of two positions for each channel: Hold, where the servo maintains its last commanded position, or Failsafe, where each servo moves to a predetermined position. You may choose either mode for each channel.

The FX-40 system also provides you with an advanced battery monitoring function that warns you when the receiver battery has only a little power remaining. In this case, each servo is moved to the defined failsafe position. The battery

- Touch the [Fail Safe] button in the Linkage Menu to call the setup screen shown below.

failsafe may be released by operating a predefined control on the transmitter (default is throttle), **do not continue to fly, land as soon as possible.** Remember, if the predefined control suddenly moves to a position you did not command, land at once and check your receiver battery.

Defines servo position when signals are lost and when receiver battery voltage becomes low.

## ! WARNING

- ! For safety, always set the fail safe functions.
  - Especially set the throttle channel fail safe function so that the servo moves to the maximum slow side for airplanes and to the slow side from the hovering position for helicopters. Crashing of the model at full high when normal radio waves cannot be received due to interference, etc., is very dangerous.
  - If fail safe is reset by throttle stick, it may be mistaken for an engine malfunction and will be reset at throttle slow and the model will continue to fly. If you have any doubts, immediately land.

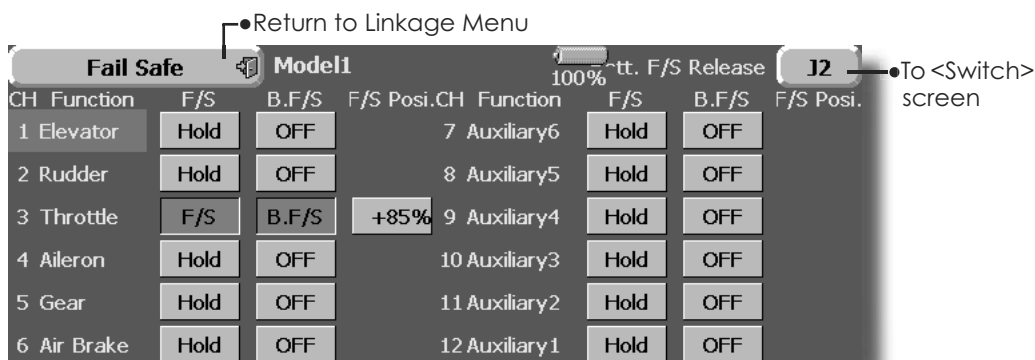

(The display screen is an example. The screen depends on the model type.)

### Fail safe setting procedure

Decide which channels you want to go to preset positions, and which ones you want to maintain their last commanded position. To select the failsafe mode you wish to set, use the F/S button. This button toggles between the two modes. (Hold, F/S)

#### F/S mode setting:

1. Touch the F/S button of the channel you want to set, and set that channel to the [F/S] mode.
2. Hold the corresponding stick, control, slider, or other control in the position you want the servo to move to when the fail safe function is activated, and touch the F/S position button. That position is displayed in percentage.

\*When you want to return that channel to the Hold mode, touch the [F/S] button again.

### Battery fail safe setting procedure

To select the B.F/S mode, touch the [B.F/S] button. Each time the button is touched, it toggles

between [OFF] and [B.F/S].

#### B.F/S setting:

1. Touch the [B.F/S] button of the desired channel to set it to the B.F/S mode.
2. Hold the corresponding stick, VR, slider, or other control in the position you want the servo to move to when the battery fail safe function is activated, and touch the F/S position button. This position is displayed in percentage.

\*When you want to return that channel to OFF, touch the [B.F/S] button again.

### Battery Failsafe Release Function

This function releases the predefined control from its held position after indicating that your receiver battery is low.

1. Enter the control setting screen by touching the Battery F/S Release button. Now, you may choose that moving the throttle resets the condition, or select another stick or switch deactivates it. To set a desired throttle release position, move the throttle stick to the point at which you wish the B.F/S to be released.



## End Point (ATV)

Sets the travel, limit point, and speed of each servo.

The End Point function adjusts the left and right servo throws, generates differential throws, and will correct improper linkage settings.

The Travel rate can be varied from 30% to 140% in each direction on channels 1 to 12. Also, the Limit point where servo throw stops may be varied from 0% to 155%.

NOTE: The indicators on the screen display actual servo throw of the each channel. The center position of the indicator is based on the Sub-Trim settings. Therefore the Sub-Trim adjustment changes the Limit point display of the indicator. The Servo Speed setting is used to set the servo delay for each channel, from channel 1 to channel 12. The system uses the programmed speed (delay) to slow down servo position changes. The Servo Speed setting can be varied from 0 to 20 in each channel.

- Touch the [End Point (ATV)] button in the Linkage Menu to call the setup screen shown below.

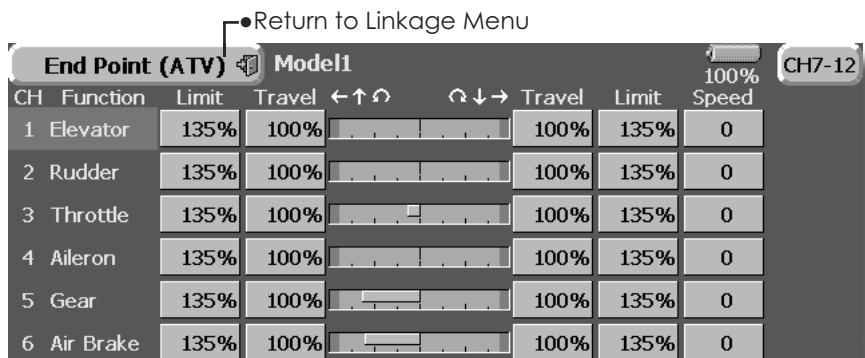

(The display screen is an example. The screen depends on the model type.)

### Servo travel adjustment

1. Touch the Travel button of the channel you want to set. Adjustment buttons appear on the screen.
2. Use these buttons to adjust the rate.
  - Initial value: 100%
  - Adjustment range: 30%~140%
3. Repeat the procedure above for each rate.

### Limit point adjustment

1. Touch the Limit button of the channel you want to set.
2. Use the adjustment buttons to adjust the limit point.
  - Initial value: 135%
  - Adjustment range: 0%~155%
3. Repeat this procedure for each limit point.

### Servo speed setting

1. Touch the Speed button of the channel you want to set.
2. Use the adjustment buttons to adjust the servo speed.
  - Initial value: 0
  - Adjustment range: 0~25 (steps)
3. Repeat this procedure for each channel.

To close this screen, touch the [End Point (ATV)] button.

## Throttle Cut Stops the engine safely and easily.(airplane and helicopter only)

Throttle cut provides an easy way to stop the engine, by flipping a switch with the throttle stick at idle. The action is not functional at high throttle to avoid accidental dead sticks. The switch's location and direction must be chosen, as it defaults to NULL.

- Touch the [Throttle Cut] button in the Linkage Menu to call the setup screen shown below.

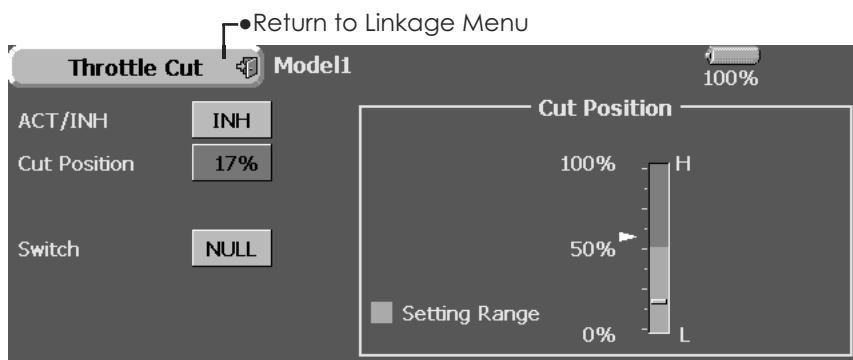

(The display screen is an example. The screen depends on the model type.)

### Throttle cut setting procedure

1. Touch the "INH" button to activate the Throttle Cut function.
2. Throttle cut function switch setting:  
Touch the "NULL" button to call the <Switch> screen, and then select the switch and its ON direction.  
(For a detailed description of the selection method, see [Switch Setting Method] at the back of this manual.)
3. Throttle cut position setting:  
Set the throttle stick to maximum slow, and touch the Cut Position button. Adjustment buttons appear. At the same time, the numerical value of the current maximum slow side is displayed at "Cut Position".

Use the adjustment buttons to adjust the servo travel when the throttle cut function is activated.

- Initial value: 17%
- Adjustment range: 0%~50%

\*With throttle stick at idle, adjust the rate until the engine consistently shuts off, but throttle linkage is not binding. When finished, touch the "Throttle Cut" button to exit.

To exit the setting, touch the [Throttle Cut] button.

## Idle Down

Lowers the engine idling speed.(airplane and helicopter only)

The Idle Down function lowers the engines idle by flipping a switch with the throttle stick at idle. The action is not functional at high throttle to avoid accidental dead sticks. The switch's location and direction must be chosen, as it defaults to NULL.

- Touch the [Idle Down] button in the Linkage Menu to call the setup screen shown below.

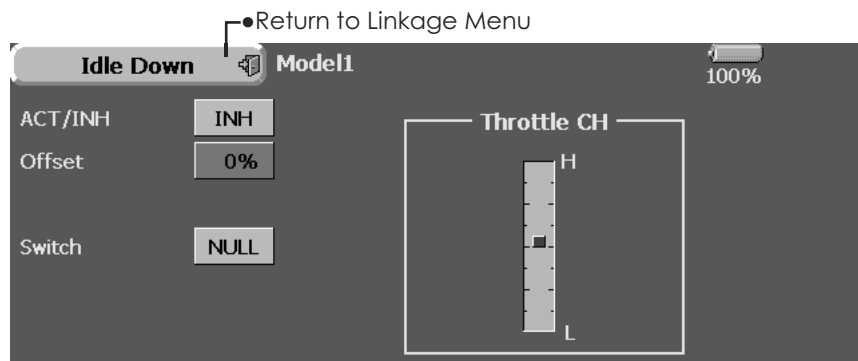

(The display screen is an example. The screen depends on the model type.)

### Idle down setting procedure

1. Touch the "INH" button to activate the Idle Down function.
2. Idle Down function switch setting:  
Touch the "NULL" button to call the <Switch> screen, and then select the switch and its ON direction.  
(For a detailed description of the selection method, see [Switch Setting Method] at the back of this manual.)
3. Offset rate setting:  
Touch the Offset Rate button. Adjustment buttons appear on the screen.  
Use these buttons to adjust the offset rate.
  - Initial value: 0%
  - Adjustment range: 0%~100%

To exit the setting, touch the [Idle Down] button.

# Swash

Swash operation linkage correction function  
(This swash setup screen does not appear for swash type H-1.)

## Neutral Point

At your linkages, if the servo horn deviates from the perpendicular position at neutral, the linkage compensation functions may not compensate effectively. This neutral point setting reads the linkage compensation neutral position. However, this adjustment only changes the datum point of the compensation function on the swash details screen and does not affect the neutral position of other functions.

\*Before using the compensation function, set the neutral point.

## Swash AFR

The swash AFR function adjusts (increases/decreases/reverse) the rate (travel) of the aileron, elevator, and pitch functions.

## Mixing Rate

(Normally, the initial value is used.)

This mixing rate is used for correction so that the swash plate moves in the correct direction for aileron, elevator, and pitch operation.

Compensation mixing is shown below.

\*PIT->AIL/PIT->ELE/AIL->PIT/ELE->AIL/ELE->PIT

\*Use the corresponding compensation mixing and compensate so that the swash plate moves in the correct direction.

## Linkage Compensation

This compensation mixing is used to correct for mutual interference when the ailerons or elevators were operated when the throttle stick was in the slow or high position.

## Speed Compensation

This speed compensation function compensates the mutual interference when the travel of each servo is different at swash plate operation. For HR-3, it compensates the speed by dropping the operating speed of the aileron and pitch servos at elevator operation.

- Touch the [Swash] button in the Linkage Menu to call the setup screen shown below.

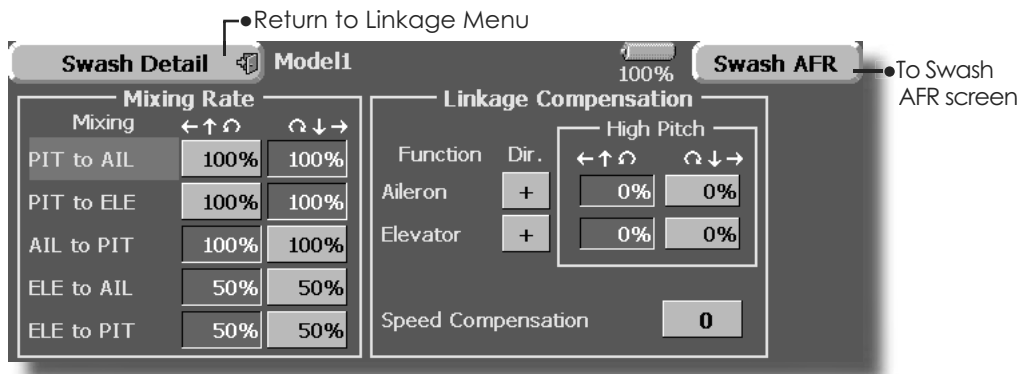
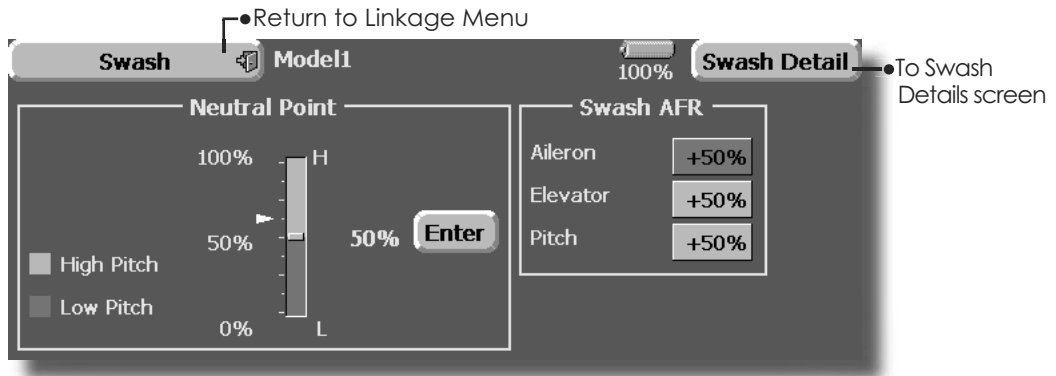

### **Neutral point setting procedure**

\*Becomes the compensation datum point.

\*Adjusting the servo horn so that the neutral point position is near the 50% position makes the mixing amount small.

1. Hold the servo horn at a right angle to the linkage rod, and then touch the [Enter] button and read the actual neutral point.

\*The neutral point is displayed on the screen.

After reading this neutral point, use other compensation functions to make further adjustments.

To exit the setting, touch the [Swash] button.

### **Swash AFR setting procedure**

Adjust so that the specified operation amount is obtained by aileron, elevator, and pitch operation.

1. Touch the button of the AFR rate to be adjusted. Adjustment buttons appear on the screen.
2. Use the adjustment buttons to adjust the AFR rate.

Initial value: +50%

Adjustment range: -100%~+100%

To exit setting, touch the [Swash] button.

### **Mixing rate setting procedure**

HR-3 is described as an example. The mixing applied in other swash modes is different, but the setting procedure is the same.

1. Set the throttle stick to the set neutral point. Adjust the length of the linkage rod so that the swash plate is horizontal at this position.

\*A little adjustment using sub trim should be OK.

\*Adjust so that pitch operation when the pitch curve is straight is maximum.

2. Adjust the AIL->PIT amount so there is no interference in the elevator or pitch direction when the aileron stick is moved to the left and right.

\*Adjust the left and right sides separately.

3. Adjust the ELE->AIL and ELE->PIT amounts so there is not interference in the aileron or pitch direction when the elevator stick is moved up and down.

\*Adjust the up and down sides separately.

4. Adjust the PIT->AIL and PIT->ELE amounts so that the swash plate is horizontal when the throttle stick is set to maximum slow and full high.

\*Adjust the slow and high sides separately.

To exit setting, touch the [Swash Details] button.

### **Linkage correction setting procedure**

\*Set the linkage compensation after setting the mixing rate.

\*This function compensates for elevator interference by aileron operation or aileron interference by elevator operation at Low pitch and Hi pitch at collective pitch (HR3, etc.) control.

1. Set the throttle stick to the maximum slow position. Move the aileron stick to the left and right and adjust the aileron compensation amount so that interference in the elevator or pitch direction at that time is minimal.

\*The left and right sides can be adjusted separately.

\*If the interference increases when the compensation amount is increased, make the compensation direction "-".

2. Adjust the elevator compensation amount so that the interference in the aileron or pitch direction when the elevator stick was moved up and down is minimal.

3. Perform aileron and elevator compensation similarly for the throttle stick full high side.

To exit setting, touch the [Swash Details] button.

### **Speed compensation setting procedure**

1. Set the throttle stick to the neutral point position. Move the elevator stick quickly and adjust the speed compensation amount so that the interference in the pitch direction is minimal.

To exit setting, touch the [Swash Details] button.

#### **Notes:**

If the linkage sticks out or is stretched tight, correct compensation will not be applied. Perform correction with surplus linkage.

The pitch angle changes after adjustment. Reset the pitch angle when actually flying after compensation processing.

## Timer Timer setting and lap time display.

The Timer function may be set for any desired time, i.e. engine run time, specified times for competitions, etc. Two independent timers are provided for your use. The timers are stored independently with each model, meaning that when you switch between model setups, the timer associated with the new model is brought up automatically.

The timers may be set to start and stop from the motion of any switch or stick. You may set the ON and OFF directions freely. Each timer has a capacity of up to 59 minutes 59 seconds.

Each timer may be set for count-down or count up operation with a target time. Also Split Time may be counted.

If a target time is set and the timer reaches the set time, a buzzer sound for each count is generated.

Countdown timers sound one short beep during the last twenty seconds and two short beeps during the last ten seconds before reaching the target, then a long tone at the target time, and continue counting with displaying a minus (-) sign. Count-up timers also beep the last twenty and ten seconds, beep the target time, and keep counting upwards until shut down.

- Touch the [Timer] button in the Linkage Menu to call the setup screen shown below.

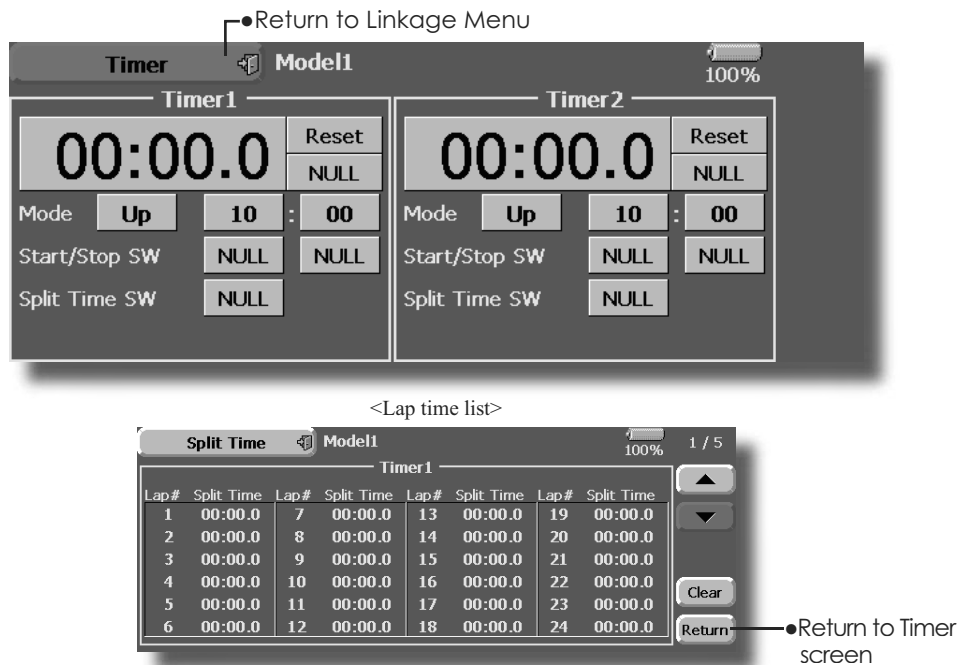

### Up timer/down timer selection

1. Touch the mode button and select the type of timer.  
\*Each time this button is touched, it toggles between UP and DOWN.
2. Timer time setting  
Touch the Mode minutes or seconds button. Adjustment buttons appear on the screen. Use these buttons to set the timer time.

### Start/stop switch setting

1. Touch the Start/Stop SW "NULL" button to call the <Switch> screen, and then select the switch and its ON direction.  
(For a detailed description of the selection method, see [Switch Setting Method] at the back of this manual.)

### Lap time switch selection

1. Touch the Lap SW "NULL" button to call the Prog. Mix screen, and then select the switch and its ON direction.  
(For a detailed description of the switch setting method, see [Switch Setting Method] at the back of this manual.)

### Timer operation

- Timer 1 and Timer 2 are started and stopped by start/stop switch set beforehand.
- To count the lap time, operate the lap time switch selected beforehand. Each time this switch is operated, the lap time is stored. To display the lap time, touch the respective [List] button.
- To reset a timer, touch the respective [Reset] button.  
To exit the setting, touch the [Timer] button.

## Dial Monitor

LDisplays the position of the dials, slider levers, and digital trim.

### Digital Trim Position display (T1-T8, CD)

The Dial Monitor displays the current position and the operation step amount of each Digital Trim. The trim step can be set directly on the dial monitor menu.

### VR and slide lever position display (LD, RD, L1-L3)

Displays the current position (black▼) and last operating position (green△) of the VRs and slider levers.

- Touch the [Dial Monitor] button in the Linkage Menu to call the setup screen shown below.

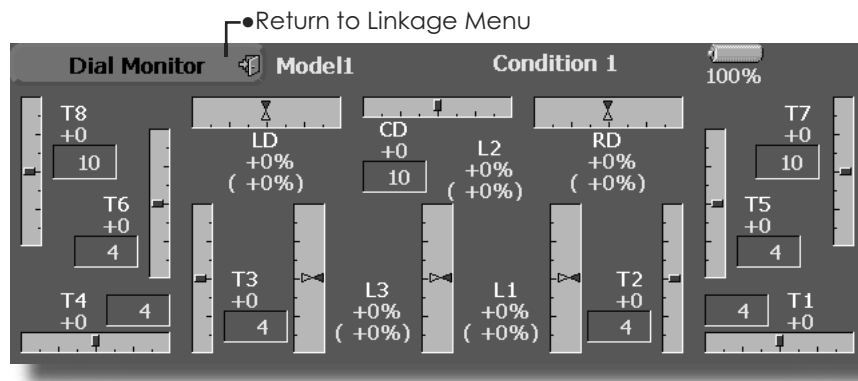

### Knob and Lever Position display (LD, RD, LS, L1-L3)

The Dial Monitor displays the current position and last operation position of each knob and lever. Although neither knob nor lever can hold the last operation position because of they are “analog” type, the position data during the last operation is memorized in the model memory. By moving the knob and lever to the position displayed on this monitor, the last operation position is recalled.

### Recalling Dial Position (LD, RD, LS, L1-L3)

The dial position data at the last operation is displayed for each knob and lever in this monitor. (Green arrow)

1. Move the black arrow (current position) to the green arrow position by operating the desired knob or lever to recall the last operating position.

## Data Reset

Model memory setting data reset. (by item)

This function is designed to allow you to reset selected portions or all of the settings saved in the active model memory. You may individually choose to reset the following sets of data;

### T1~T8, CD:

Reset the digital trim setting.

\*All the conditions, or the condition currently being displayed (the entire group for group setting), can be selected.

### Direct key:

Resets direct key assignment.

### Model menu setting:

Resets all the functions in the Model Menu except Condition Select.

### All model setting:

Resets all Linkage and Model Menu functions except for Frequency, Model Select, and Model Type.

- Touch the [Data Reset] button in the Linkage Menu to call the setup screen shown below.

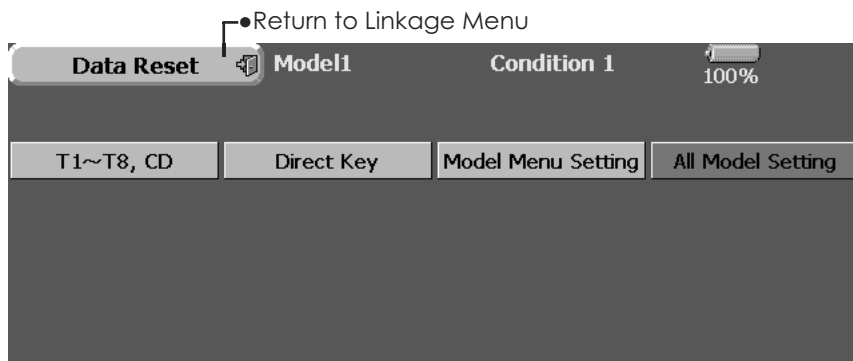

### Data Resetting

1. Touch the desired button to reset the set of data.
2. Perform the data resetting according to the instructions displayed on a screen. When complete, touch the Data Reset button to exit.



## MODEL MENU (COMMON FUNCTIONS)

This section describes the AFR, program mixing, and other functions common to all model types.

Before setting the model data, use the Model Type function of the Linkage Menu to select the model type matched to the aircraft. When another model type is selected thereafter, the AFR, program mixing, and other setting data are reset.

The functions in the Model Menu can be set for each flight condition. When you want to use the system by switching the settings for each condition by switch, stick position, etc., use the Condition Select function to add flight conditions. (Up to 8 conditions can be used)

Note: The FX-40 is designed so that the airplane and glider (including EP glider) model types are compatible with aircraft of similar type wings. This section outlines the relationship between the functions common to airplanes and gliders, except some dedicated functions, and model type. The setting items depend on the number of servos and other differences according to the wing type used, but reread them. The setup screens in the instruction manual are typical examples.

- Touch the Model Menu button of the Home screen to call the Model Menu.
- When the button of the function you want to set is touched, a setup screen appears.

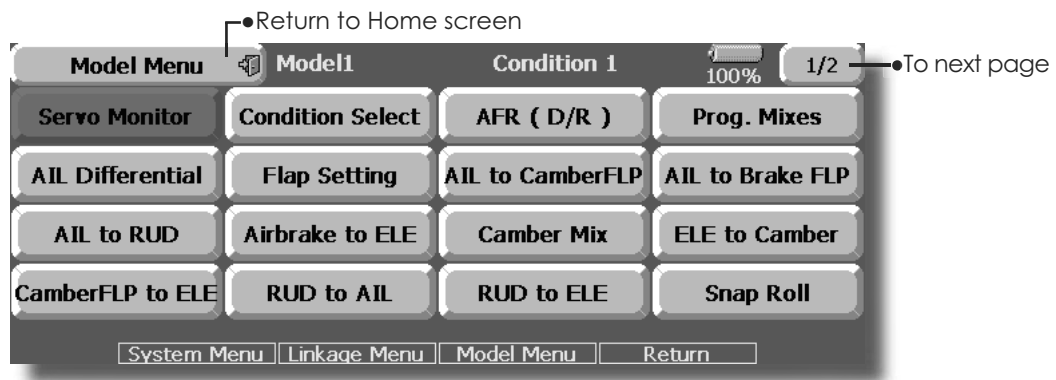

(Model Menu screen example)

\*The Model Menu screen depends on the model type. This screen is for model type 4AIL+4FLP.

### Model Menu functions (Common) list

#### •Servo Monitor

Servo test and servo position display (For a description of its functions, see the Linkage Menu section.)

#### •Condition Select

Flight conditions addition, deletion, copy, condition renaming, and condition delay can be set.

#### •AFR (D/R)

Sets the angle and curve of all the operation functions. A D/R curve which can be activated with a switch, etc. can also be added.

#### •Prog. Mixes

Program mixing which can be freely customized. Up to 10 mixes can be used for each condition.

#### •Fuel Mixture

Mixing used in needle adjustment of engines which use a fuel mixture control carburetor. [Airplane, helicopter]

## Condition Select

Flight conditions addition, deletion, copy, condition renaming, and condition delay can be set. [All model types]

The functions in the Model Menu can be used by switching the settings of up to 8 flight conditions by using the Condition Select function to add flight conditions.

When you do not want to use the Condition Select function, this setting is unnecessary. In this case, use the flight conditions (Condition 1) assigned at initial setting.

- Since switching by stick and lever position, in addition to ordinary toggle switch, is possible as the flight condition selector switch, this function can be linked with other operations.
- A Condition Delay function can be set. Unnecessary fuselage motion generated

when there are sudden changes in the servo positions and when there are variations in the operating time between channels during condition switching can be suppressed. The delay can be set for each channel.

When setting the delay function at the switching destination condition, the related function changes after a delay corresponding to the set amount.

- When multiple conditions were set, their operation priority can be freely changed.
- The condition name can be changed. The selected condition name is displayed on the screen. When a condition has been added, give it a name which can be easily confirmed.

- Touch the [Condition Select] button in the Model Menu to call the setup screen shown below.

The screenshot shows the 'Condition Select' screen for 'Model1'. At the top, there is a 'Return to Model Menu' button, a 'Condition List' section showing '1 Condition 1', and a 'Priority' section. Below the list are buttons for 'Add', 'Delay', 'Copy', and 'Rename'. A progress indicator shows 'Condition 1' at '100%'. Callouts point to various parts of the screen and provide detailed instructions for each function.

### Priority change

1. Touch the condition whose priority you want to change in Conditions List.
2. Change the priority with the priority [△] or [▽] button. (The last condition has the highest priority.)

\*The initial setting condition cannot be moved. It has the lowest priority.

### Condition Addition

1. When the [Add] button is touched, the Condition Select screen appears.

\*Only the number of buttons corresponding to the conditions which can be added are displayed.

2. Select the desired conditions by touching the buttons.

\*The selected conditions are added to Conditions List.

3. Touch the [NULL] button to call the <Switch> screen.
4. Select the switch to be used in condition switching.

(For a description of the switch selection method, see next page.)

5. The "Condition 1" data for the added conditions is copied.

### Condition Reset

1. Select the condition by touching the condition you want to reset in Conditions List.
2. Touch the [Reset] button.
3. When the [Yes] button is touched, the condition is reset. (To abort resetting, touch the [No] button.)

### Condition delay setting

•Condition delay setting  
(For a description of the setting method, see the next page.)

### Condition Renaming

1. Select the condition by touching the condition you want to rename in Conditions List.
2. Touch the [Rename] button.
3. Enter the new name from the keyboard which appears on the screen. (For a description of the method of using the Japanese language conversion mode, see "Characters Input Method" of the Basic Operation section.)
3. When the keyboard [Return] key is touched, the new name is registered. (To abort registration, touch the [ESC] key.)

### Condition Copy

1. Touch the [Copy] button. The Copy screen appears.
2. Select the condition by touching the button of the copy source conditions.
3. Next, select the condition by touching the copy destination condition.
4. Touch the [COPY] button.
5. When the [Yes] button is touched, the data is copied. (To abort copying, touch the [No] button.)

### (Switch selection screen)



- The flight conditions are selected by two switches status combination as a logical equation. The supported logic are AND, OR, EOR (exclusive OR). The mode button is selection of either conventional(Single) or logical(Logic) switch mode.

Select logic mode, then two switches selection and coupling logic button appear. Set the two switches and logic to be activated the logical switches. The input and logical output are as follows.

SW1	SW2	AND	OR	EOR
0	0	0	0	0
0	1	0	1	1
1	0	0	1	1
1	1	1	1	0

(0= off, 1= on)

- Touch the [Delay] button on the Condition Select screen to call the Condition Delay screen shown below.

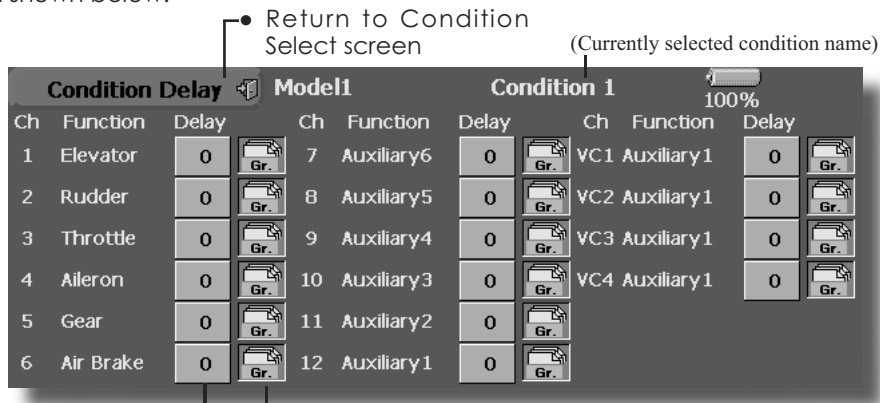

**Condition delay setting**

- Switch to the condition you want to set.
- Touch the Delay button of the channel you want to set.
- Use the adjustment buttons to set the delay.
  - Initial value: 0
  - Adjustment range: 0~27 (maximum delay)

- Group/single mode switching (Gr./Sngl)
- (For a description of the operation method, see the description at the back of this manual.)

## Condition Hold (Helicopter Only)

This function may be used to limit the maximum speed of the engine so that you may adjust flight conditions when the engine is running. The maximum throttle position is settable, and an alarm indicates that the function is operating. The function is especially useful for helicopters, because it will prevent the engine from racing dangerously when adjusting the Idle-Up settings.

While this function is active, the throttle operates on the default condition throttle curve, and mixing is applied as normal, except the throttle is not allowed to move past the set point.

You must deactivate this function when you are

through making adjustments. The system will not allow you to deactivate this function in either of the following states:

- When any of the flight condition switches are on.
- When the throttle stick is higher than the set point.

### To activate Condition hold:

- Set the throttle stick at a position 3/4 below full throttle.
- Press the Condition Hold box in the lower left hand corner of the Model Menu or Linkage Menu screens.

## AFR (D/R)

The angle and curve of each operation function can be set. A D/R curve which can be switched by switch, etc. can also be added. [All model types]

AFR function is used to adjust the throw and operation curve of the stick, lever, and switch functions (CH1 to CH12, and V1 to V4) for each flight condition. This is normally used after End Point (ATV) has defined the maximum throw directions (End Point acts on ALL flight condition settings). When mixing is applied from one channel to another channel, both channels can be adjusted at the same time by adjusting the operation rate through the AFR function.

### Setting method

- Operation curve adjustment: Six types of curves (linear, EXP1, EXP2, VTR, line and spline) can be selected. A maximum 17 points curve can be used for the line and spline curve types. (Initial setting: 9 points) The number of points can also be increased and decreased and curves from complex curves to simple curves can be used.
  - Operation speed adjustment: The operation speed of each function when the function is operated (including at flight condition switching) can be adjusted. The function operates smoothly at a constant speed corresponding to the set speed.
- Touch the [AFR (D/R)] button in the Model Menu to call the setup screen shown below.

(Currently selected rate name: AFR, D/R1~6)

**Function selection**

1. When the function select button is touched, a selection screen appears.  
2. Select the function you want to set at the selection screen.

• Group/single mode switch (Gr./Sngl)  
(For more information, see the description at the back of this manual.)

• Return to Model Menu (Currently selected condition name)

• Operation curve setting  
(For a description of the setting method, see the description at the back of this manual.)

• Servo speed setting  
(For a description of the setting method, see the description at the back of this manual.)

• D/R function setting

(Total number of AFR and D/R curves set at the currently selected condition)

**Screen mode switching**

When setting the D/R function, the screen display mode can be changed. Each time the button is touched, the mode is switched.

\*[Sngl](initial setting): Only the currently operating curve is displayed.

\*The AFR and D/R curves set at the currently operating condition are displayed.

\*[All Cond.]: The AFR curve set at all conditions is displayed.

## Dual Rate setting

Up to 6 dual rates can be set for each condition.

\*D/R (Dual Rate) is set for each condition, and is not reflected at other conditions.

\*D/R (Dual Rate) at the top of the D/R list has priority.

## Setting method

- Touch the [D/R] button from the AFR (D/R) screen of the function (ailerons, elevators, etc.) whose dual rate you want to set. The D/R list screen shown below is displayed. Touch the (function) button of the dual rate number to be assigned. That rate is automatically assigned to that function.
- Next, select the switch and its ON/OFF directions.

**Close**

- At the end of each setting, touch the [Close] button.

**Start D/R1**

- To start D/R1, touch the [INH] button.

**Function change**

- When the aileron button is touched, the system asks for a [Yes] or [No]. To change the function, switch to the function selected at the AFR screen by answering [Yes].

	D/R	D/R	Function	Switch
1	INH	D/R 1	Aileron	NULL
2	INH	D/R 2	Aileron	NULL
3	INH	D/R 3	Aileron	NULL
4	INH	D/R 4	Aileron	NULL
5	INH	D/R 5	Aileron	NULL
6	INH	D/R 6	Aileron	NULL

**Naming D/R1**

1. To name D/R1, touch the [D/R1] button. A keyboard appears on the screen.
2. Enter the desired name from this keyboard and register it by touching the keyboard [Return] key. To cancel input and close the screen, touch the [ESC] key.

**Switch setting**

1. Touch the [NULL] button. The <Switch> screen appears.
2. Select (confirm) the switch and its ON direction.

**Setting example**

- Rudder ON/OFF by switch. When D/R is used by using the condition with the same switch, another rudder angle can be set.

## Prog. Mixes

Program mixing which can be freely customized. Up to 10 mixings can be used for each condition. [All model types]

Programmable mixing may be used to correct undesired tendencies of the aircraft, and it may also be used for unusual control configurations. Mixing means that the motion of a command channel, called the "master," controls the motion of the mixed channel, called "slave."

You may choose to have the Masters trim added to the Slave channel response, if you desire ("Trim" setting). The mixing curve can be changed so that the undesired tendencies can be corrected effectively by setting the LINEAR1/LINEAR2/EXP1/EXP2/VTR/LINE/SPLINE modes. The Delay function can be programmed for each rate. The Delay is used to change the rate smoothly when switching. You may define Mixing ON/OFF switch, control or you may choose to

have mixing remaining on all the time.

Offset-type mixing applies a fixed offset or preset to the programmed channel servo operation and may control up to four circuits simultaneously.

The Programmable mixing includes a link function, which allows Programmable mixing to be linked with the special mixing functions, or with other programmable mixing functions. The link function can be set up for Master and Slave channel individually.

The slave channel AFR mode (STK-STK mode) may be selected, where the slave channel AFR and D/R settings are observed when Link function is set. The knob for fine tuning can be set up for every mixing circuit. (Fine tune function)

- Touch the [Prog. Mixes] button in the Model Menu to call the setup screen shown below.

• Return to Model Menu

**Prog. Mixes** Model1 Condition 1 100%

Mixing	Mode	Group	Mixing	Mode	Group
1 Inhibit	[Mode]	[Gr.]	6 Inhibit	[Mode]	[Gr.]
2 Inhibit	[Mode]	[Gr.]	7 Inhibit	[Mode]	[Gr.]
3 Inhibit	[Mode]	[Gr.]	8 Inhibit	[Mode]	[Gr.]
4 Inhibit	[Mode]	[Gr.]	9 Inhibit	[Mode]	[Gr.]
5 Inhibit	[Mode]	[Gr.]	10 Inhibit	[Mode]	[Gr.]

• Mixing buttons

After this function was activated, the master and slave function names (or offset mixing) are displayed.

• Group/single mode switching (Gr./Sngl)  
(For more information, see the description at the back of this manual.)

• Mixing mode change button

• Switch selection

• Servo speed setting

**Prog. Mixes 1** Model1 Condition 1 100%

INH	NULL	Speed	POS	+0.0%	RATE	+0.0%	Linear	Separate
Master	Slave		+150				Rate A	Rate B
Aileron	Elevator		+100				+0.0%	+0.0%
Trim	STK→STK	Display	+50				Offset	X offset
OFF	OFF	Single	+0				+0.0%	+0.0%
Mem.	NULL	Fine Tuning	-50					
			-100					
			( +0% )					
			-150					

• Operation curve setting

• Fine tuning trim setting

(Timer mode)

**Prog. Mixes 1** Model1 Condition 1 34%

Slave	Mode	ON	Offset	OFF	H/W	Fine Mode	Rate	Speed	Delay
1 Aileron	[Mode]	[ON]	+0.0%	+0.0%	NULL		+0%	+0	0.0s
2 Aileron	[Mode]	[ON]	+0.0%	+0.0%	NULL		+0%	+0	0.0s
3 Aileron	[Mode]	[ON]	+0.0%	+0.0%	NULL		+0%	+0	0.0s
4 Aileron	[Mode]	[ON]	+0.0%	+0.0%	NULL		+0%	+0	0.0s
INH	Switch	NULL							

(Normal mode)

**Timer mode**

The on time (start/stop time) can be set up to 9 seconds. It is useful for landing gear control of the jet or scale plane, etc.

## Setting methods

### ●Group/single mode selection

Activating functions for only the selected conditions:

1. Touch the Group button and switch to the Sngl mode.

\*Each time the button is touched, it toggles between the Gr. and Sngl modes.

### ●Mixing mode selection

Using the offset mode:

1. Touch the Mode button and switch to the Offset mode.

\*Each time the button is touched, it toggles between the Mix and Offset modes.

### ●Mixing setup screen selection

1. Touch the button of the mixing you want to set. The mixing setup screen is displayed. Activate the function.

2. Activate the function by touching the [INH] button.

\*Each time this button is touched, it toggles between [INH] and [ON/OFF].

### ●Mixing ON/OFF switch setting and ON/OFF direction switching

\*An ON/OFF switch is not set even when the function is activated.

1. When you want to turn mixing ON/OFF by switch, touch the [NULL] button to call the <Switch> screen and then select the switch and its ON direction.

\*For a description of the selection method, see [Switch Setting Method] at the back of this manual.

### ●Master channel setting (except offset type mixing)

1. Touch the Master button to call the Function menu and select the master channel.

2. To link this mixing with other mixing, touch the button at the left of the master channel and select link.

\*Each time the button is touched, it toggles between mixing direction + and - and "No display" (no link).

\*Master channel control can be set to stick, VR, and other simple travels which do not include ATV, AFR, D/R, mixing setting, etc. In this case, display the <Switch> screen by touching the [H/W] button and then select master channel side control.

### ●Slave channel setting

1. Touch the Slave button to call the Function menu and select the slave channel.

2. To link this mixing with other mixing, touch the button at the right-hand side of the slave channel and select link.

\*Each time the button is pressed, it toggles between mixing direction + and - and "No display" (no link).

### ●Trim mode ON/OFF setting

1. To turn the trim mode ON/OFF, touch the Trim button on the screen.

\*When mixing includes master side trim, set the Trim button to [ON]. When mixing does not include master side trim, set the Trim button to [OFF].

\*Each time this button is pressed, it toggles between [ON] and [OFF].

\*This is effective when the master channel is set by Function.

### ●Slave channel AFR mode (STK→STK)

1. When Link is set at the slave side, and you want to add AFR (D/R) to the mixing rate, select [ON]. When you do not want to add AFR (D/R) to the mixing rate, select [OFF].

\*Each time this button is pressed, it toggles between [ON] and [OFF].

\*This is effective when making corrections when the fuselage is the same but the rudder angles are substantially different.

### ●Mixing curve type selection

1. Touch the curve type selection button of the curve type you want to use to display the selection screen and then select the curve you want to use.

\*For a description of the curve setting method, see the description at the back of this manual.

### ●Fine tuning trim setting

1. When using the curve fine tuning function, touch the [NULL] button of the Fine Tuning item to call the <Switch> screen and then select the lever, VR, etc. you want to use.

\*For a description of the fine tuning trim setting method, see the description at the back of this manual.

### ●Servo speed setting

1. When setting the servo speed, touch the Speed button. The Servo Speed setup screen is displayed.

\*For a description of the servo speed setting method, see the description at the back of this manual.

\*Offset mixing changes the speed. Use the Speed In and Speed Out buttons to readjust the speed..

The mixing switch can set a delay with a different rate at starting and stopping.

\*This function is inactive when a mixing switch is not set.

## Fuel Mixture

Mixing used in needle adjustment of engines which use a fuel mixture control carburetor. [Airplane, helicopter]

This function is dedicated mixing used in needle adjustment of an engine that uses a fuel mixture control carburetor.

\*The needle channel is assigned to CH9 as a default.

- Touch the [Fuel Mixture] button in the Model Menu to call the setup screen shown below.

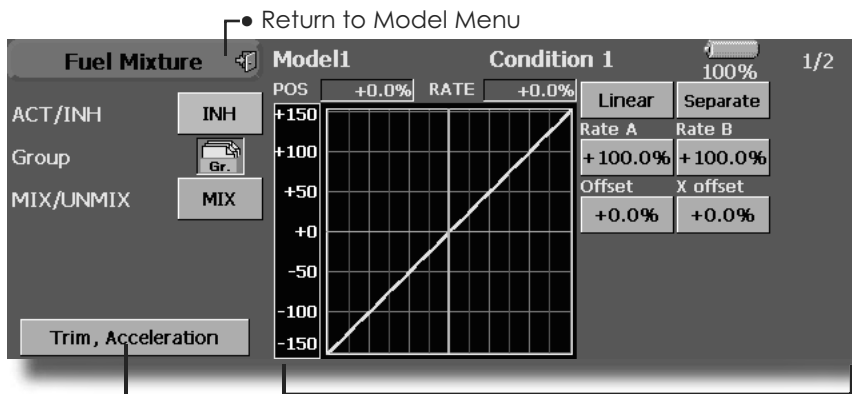

- Operation curve setting

(For a description of the setting method, see the description at the back of this manual.)

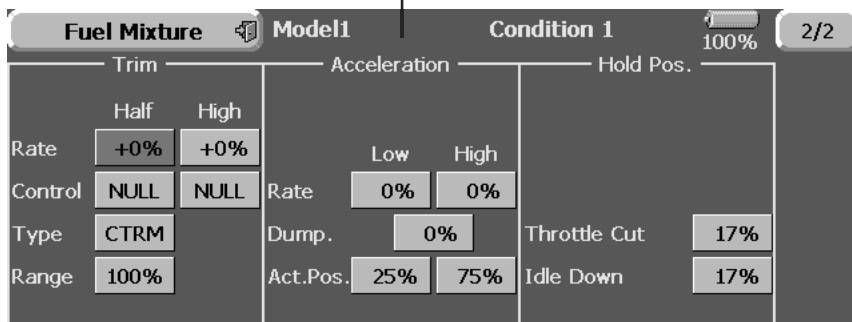

### Setting method

**CTRM mode:** Maximum amount of change near center by center trim operation. When the adjustment range (Range) value is made small, trim is active only near the center.

**NORM mode:** Normal trim (parallel movement trim) operation. When the adjustment range (Range) value is made small, trim is active only near the center. Needle high trim works as high trim based on the center. This operation is similar to reverse ATL trim.

1. An acceleration function can be set. This function is used when there are symptoms of the mixture being either too rich or too lean, which would be generated by sudden operation of the throttle stick.

An acceleration (ACLR) function and deceleration (DCLR) function, which temporarily increase and decrease the fuel supply at acceleration and deceleration, can be set.

2. The return time after operation (Dump) can be set for both setting at acceleration (High) and setting at deceleration (Low).
3. A needle throttle cut function can be set.
4. Operation linked with the throttle hold functions (Cut and Idle), Throttle Cut function, and Idle Down function is possible.
5. The needle side cut position can be set. Set it to the fuel side full open position.

When the **MIX** mode is selected, the throttle curve set data becomes the mixing master. In the **UNMIX** mode, the throttle stick position becomes the mixing master.



## MODEL MENU (AIRPLANE/GLIDER FUNCTIONS)

These functions usable when airplane, glider, or EP glider model type is selected are displayed in this Model Menu functions section. First use the Model Type function of the Linkage Menu to preset the model type, wing type, and tail type matched to the fuselage used. Later setting resets the data set by mixing function, etc.

These functions can be set for each flight condition, as required. When you want to use the system by switching the settings for each condition by switch or stick position, use the

Condition Select function to add flight conditions. (Up to 8 conditions can be used)

Note: The FX-40 is designed so that the airplane and glider (including EP glider) model types can handle aircrafts of the same wing type.

The functions common to airplanes and gliders, except some functions, summarized without regard to the model type.

The setting items are different, depending on the number of servos, etc. according to the wing type used. However, reread them. The setup screens in the instruction manual are typical examples.

- Touch the Model Menu button of the Home screen to call this Model Menu.
- When the button of the function you want to set is touched, a setup screen appears.

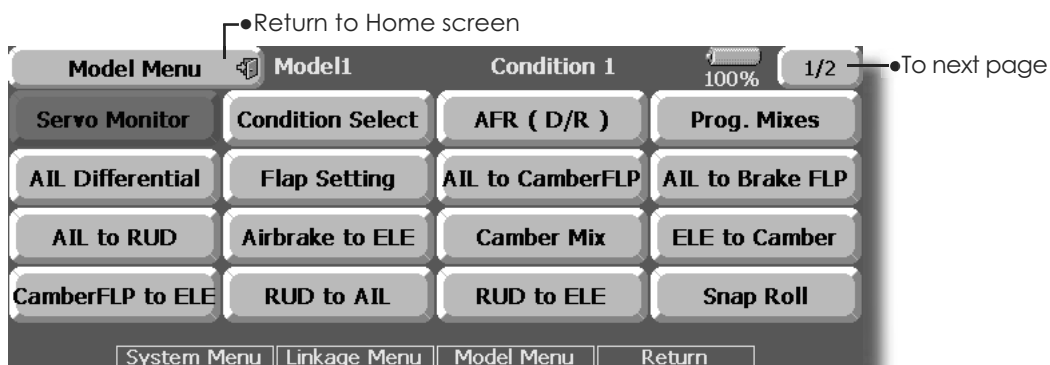

(Model Menu screen example)

\*The Model Menu screen depends on the model type. This screen is for model type 4AIL+4FLP.

### Model Menu functions list

#### •AIL Differential

This function adjusts the left and right ailerons. Roll axis correction and fine tuning with a VR are also possible. This is convenient when making settings during flight.

[Airplane/glider, 2 ailerons or more]

#### •Flap Setting

The flaps can be adjusted independently. For a 4 flaps model, the camber flaps can be mixed with the brake flaps. [Airplane/glider, 2 flaps or more]

#### •AIL to Camber FLP

This mixing operates the camber flaps in the aileron mode. It improves the operation characteristic of the roll axis. [Airplane/glider, 2 ailerons + 2 flaps or more]

#### •AIL to Brake FLP

This mixing operates the brake flaps in

the aileron mode. It improves the operation characteristic of the roll axis. [Airplane/glider, 4 flaps or more]

#### •AIL to RUD

This mixing is used when you want to operate the rudder with aileron operation. Banking at a shallow bank angle is possible. [Airplane/glider, 2 ailerons + 2 flaps or more]

#### •Airbrake to ELE

This mixing is used to correct operation of the airbrakes (spoilers) when landing. [Airplane/glider, general]

#### •RUD to AIL

This mixing is used to correct roll maneuvers, knife edge, etc. of stunt planes. [Airplane/glider, general]

● **Camber Mix**

Adjusts the camber and corrects the elevators.  
[Airplane/glider, 2 ailerons or more]

● **ELE to Camber**

Used when you want to mix camber flaps with elevator operation. Lifting force can be increased at elevators up. [Airplane/glider, 2 ailerons or more]

● **Camber FLP to ELE**

Used to correct for attitude changes when the camber flaps are being used. [Airplane/glider, 2 ailerons + 1 flap or more]

● **Butterfly (Crow)**

Used when powerful brake operation is necessary. [Glider, 2 ailerons or more]

● **Trim Mix 1/2**

The ailerons, elevators, and flaps trim offset rate can be called by switch or condition selection. [Glider, 2 ailerons or more]

● **Airbrake**

This is used when airbrakes are necessary when landing or when diving, etc. during flight. (Airplane, general)

● **Gyro**

This is dedicated mixing when a GYA Series gyro is used. [Airplane/glider, general]

● **V-tail**

Adjusts the elevators and rudder of V-tail models. [Airplane/glider, V-tail specifications]

● **Ailevator**

Adjusts the elevators and ailerons of models with elevator specifications. [Airplane/glider, elevator specifications]

● **Winglet**

Adjusts the left and right rudders of winglet models. [Airplane/glider, winglet specifications]

● **Motor**

The operation speed when the motor of F5B and other EP gliders is started by switch can be set. [EP glider, general]

● **RUD to ELE**

This is used to correct roll maneuvers, knife edge, etc. of stunt planes. [Airplane, general]

● **Snap roll**

This selects the snap roll switch and adjusts the steering angle of each rudder. Servo speed can also be adjusted. [Airplane general]

● **Multi Engine**

This adjusts the throttles independently when using a multi engine model. (Maximum 4 engines) [Airplane, general]

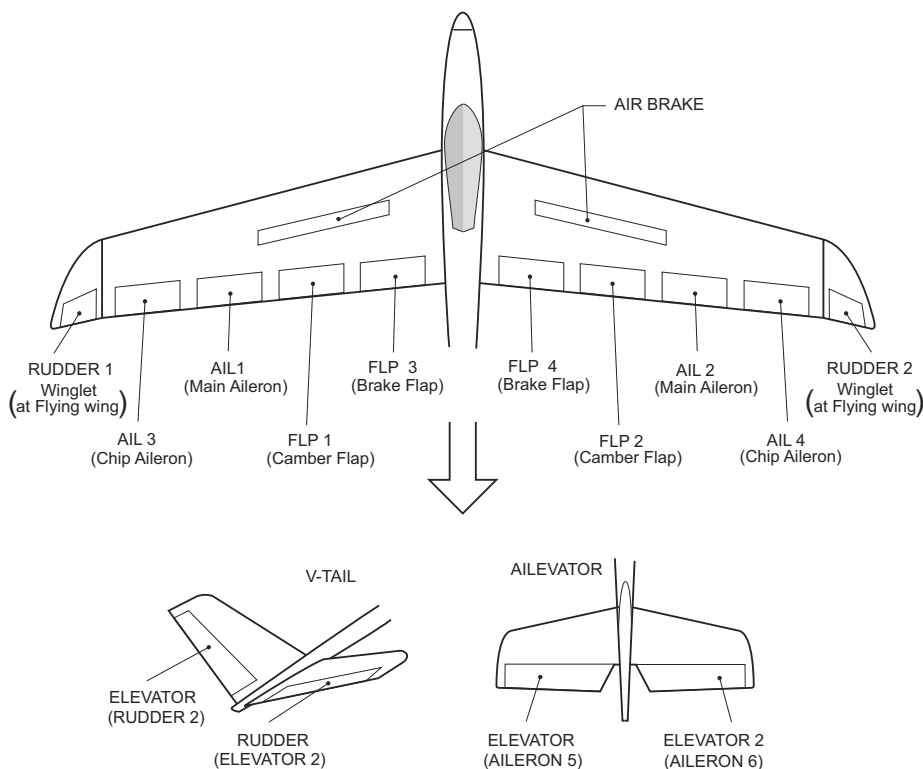

## AIL Differential [Airplane/glider, 2 ailerons or more]

The left and right ailerons differential can be adjusted independently. The differential rate can also be adjusted as needed by setting a fine tuning VR.

- A fine tuning curve can be set.

Note: Aileron up/down setting (%) reset is +100% when reset when setting is +, and -100% when reset when setting is -. Left and right mixing causes + and - to change. Before flying, confirm the direction of operation.

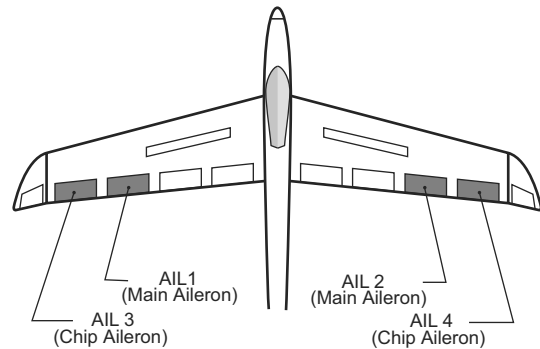

- Touch the [AIL Differential] button in the Model Menu to call the setup screen shown below.

### <Wing type: 4 ailerons screen>

\*The display screen is an example. The actual screen depends on the Model Type.

- Calls the AFR screen directly when adjusting aileron operation AFR.

AIL Differential Model1 Condition 1 100% Master

	Left	Right
AIL	100%	100%
AIL2	100%	100%
AIL3	100%	100%
AIL4	100%	100%
Fine Tuning		NULL

POS +0.0% RATE +0.0%

Linear Separate

Rate A	Rate B
+100.0%	+100.0%
Offset	x offset
+0.0%	+0.0%

Gr. Fine Tuning Curve →

Return to Model Menu

Overall adjustment by Rate A and Rate B.

• Aileron left/right adjustment

• Fine tuning curve setting (For a description of the setting method, see the description at the end the manual.)

• Fine tuning VR setting

\*The graph is operated by setting a VR, etc.

\*The display is reversed by mixing with aileron operation

• Group/single mode switching (Gr./Sngl) (For more information, refer to the description at the back of this manual.)

### Setting method

- Touch the aileron (AIL) 1~4 left (or right) button, and adjust the aileron angles when the stick is moved to the left (or right) end.
- \*The aileron AFR screen can be directly called from the AIL Differential setup screen. ([Master] button)
- When setting the fine tuning VR, touch the "NULL" button to call the <Switch> screen, and then select the fine tuning VR.
- The fine tuning rate can be set by curve.

## Flap setting

[Corresponding model type]: Airplane/glider, 2 flaps or more

The up/down travel of each flap (camber flaps: FLP1/2, brake flaps: FLP3/4) can be adjusted independently according to the wing type.

- The operation center point of each flap can be offset

The camber flaps of a 4-flap model can be mixed with the brake flaps. (Brake FLP to camber FLP)

- An ON/OFF switch can be set.

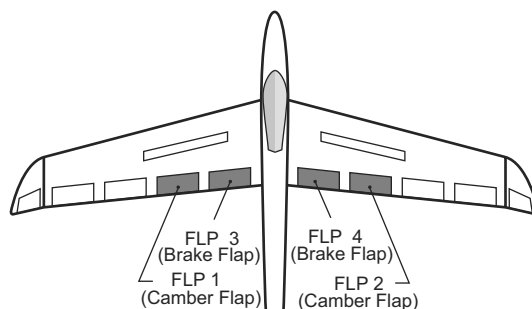

- Touch the [Flap Setting] button in the Model Menu to call the setup screen shown below.

### <Wing type: 4 flaps screen>

\*The display screen is an example. The actual screen depends on the model type.

- Group/single mode switching (Gr./Sngl)

(For more information, see the description at the back of this manual.)

•Return to Model Menu

Flap Setting		Model1	Condition 1	100%
Camber Flap		Brake Flap		B.Flap to C.Flap
Group		Group		ACT <b>INH</b>
	FLP FLP2		FLP3 FLP4	Switch <b>NULL</b>
Up	+100% +100%	Up	+100% +100%	Up +100%
Down	+100% +100%	Down	+100% +100%	Down +100%
Offset	+0% +0%	Offset	+0% +0%	Offset +0%

•Operation reference point offset

•Up side/Down side adjustment

### Setting method

- Touch the flap (FLP) 1~4 Up or Down button according to the wing type and adjust the travel independently.
- To offset the operation reference point of each flap, touch the corresponding Offset button. Use the adjustment buttons displayed on the screen to offset the reference point.
- When using Brake FLP to Camber FLP mixing, touch the ACT button and set the function to ACT (ON). When setting a switch, touch the [NULL] button of the switch to call the <Switch> screen, and then select the switch and set its ON direction. (Always ON at "NULL" setting)  
(For a description of the switch selection method, see the description at the back of this manual.)

## AIL to Camber FLP

[Corresponding model type]: Airplane/glider, 2 ailerons + 2 flaps or more

This mixing operates the camber flaps (FLP1/2) in the aileron mode. When the aileron stick is manipulated, the ailerons and camber flaps perform aileron operation simultaneously and the operation characteristic of the roll axis is improved.

- The aileron left/right mixing rate of each flap servo can be fine-tuned.
- A mixing curve can be set.
- An ON/OFF switch can be set.
- Linking is possible: Links this mixing to other mixings.

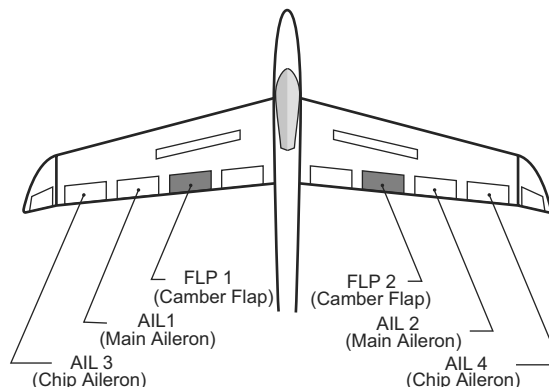

- Touch the [AIL to Camber FLP] button in the Mode Menu to call the setup screen shown below.

\*The display screen is an example. The actual screen depends on the model type.

Return to Model Menu

AIL to Camber FLP Model 1 Condition 1 100%

ACT	INH	Gr.	POS	+0.0%	RATE	+0.0%	Linear	Separate
Switch	NULL		+150				Rate A	Rate B
Link	INH		+100				+100.0%	+100.0%
			+50				Offset	X offset
			+0				+0.0%	+0.0%
			-50					
			-100					
			-150					

Left/Right overall adjustment at Rate A and Rate B

Left Right

FLP	+0%	+0%
FLP2	+0%	+0%

Adjustment of each flap servo

Mixing curve setting  
(For a description of the curve setting method, see the description at the back of this manual.)

Group/single mode setting (Gr./Sngl)  
(For more information, see the description at the back of this manual.)

### Setting method

- Touch the ACT button and set the function to ACT (ON).
- When setting a switch, touch the [NULL] button of the switch to call the <Switch> screen, and then select the switch and set its ON direction. (Always ON at "NULL" setting)  
(For a description of the switch selection method, see the description at the back of this manual.)
- Touch the left or right button of each flap servo, and adjust the mixing rate with the adjustment buttons.

\*When the mixing direction is reversed by the linkage, adjustments can be made by changing the mixing rate polarity.

- A mixing curve can be set.  
(For a description of the mixing curve setting method, see the description at the back of this manual.)
- To set linking, touch the Link button and set it to ON.

## AIL to Brake FLP

[Corresponding model type]: Airplane/glider, 4 flaps or more

This mixing operates the brake flaps (FLP3/4) in the aileron mode. When the aileron stick is manipulated, the aileron and brake flaps perform the aileron operation simultaneously and the operation characteristic of the roll axis is improved.

- The aileron left and right mixing rates can be adjusted for each flap servo.
- A mixing curve can be set.
- Mixing during flight can be turned ON/OFF by setting a stick. (Always ON at NULL setting)
- Linking can be set: Links this mixing to other mixings.

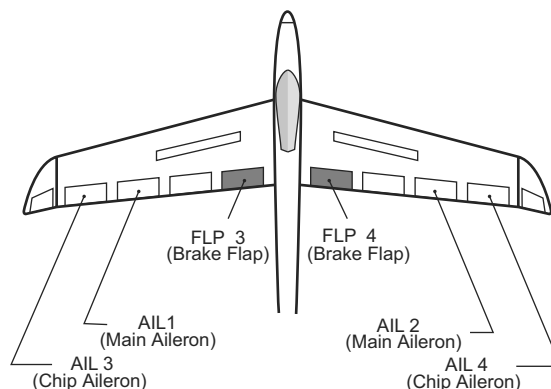

- Touch the [AIL to Brake FLP] button in the Model Menu to call the setup screen shown below.

\*The display screen is an example. The actual screen depends on the model type.

Return to Model Menu

AIL to Brake FLP Model1 Condition 1

ACT INH Gr. 100%

Switch NULL

Link INH

	Left	Right
FLP3	+0%	+0%
FLP4	+0%	+0%

POS +0.0% RATE +0.0%

Linear Separate

Rate A Rate B

+100.0% +100.0%

Offset X offset

+0.0% +0.0%

Adjustment of each flap servo

Mixing curve setting  
(For a description of the curve setting method, see the description at the back of this manual.)

Group/single mode setting (Gr./Sngl)  
(For more information, see the description at the back of this manual.)

Left/right overall adjustment by Rate A and Rate B

### Setting method

- Touch the ACT button and set the function to ACT (ON).
- When setting a switch, touch the [NULL] button of the switch to call the <Switch> screen, and then select the switch and set its ON direction. (Always ON at "NULL" setting)  
(For a description of the switch selection method, see the description at the back of this manual.)
- Touch the left or right button of each flap servo, and adjust the mixing rate with the adjustment buttons.
- When the mixing direction is reversed by the linkage, adjustments can be made by reversing the mixing rate polarity.
- A mixing curve can be set.

(For a description of the curve setting method, see the description at the back of this manual.)

- To set linking, touch the Link button and set it to ON.

# AIL to RUD

[Corresponding model type]: Airplane/glider, general

Use this mixing when you want to mix the rudders with aileron operation.

- A mixing curve can be set.
- Mixing during flight can be turned ON/OFF by setting a switch. (Always ON at NULL setting)
- The mixing rate can be fine-tuned by setting a VR.

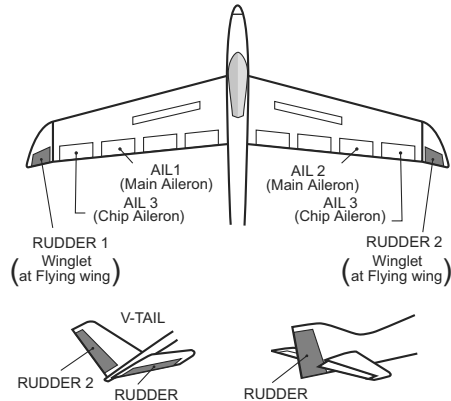

- Touch the [AIL to RUD] button in the Model Menu to call the setup screen shown below.

\*The display screen is an example. The actual screen depends on the model.

Left/right overall adjustment by Rate A and Rate B

• Return to Model Menu

• Fine tuning VR setting

• Group/single mode setting (Gr./Sngl)  
(For more information, see the description at the back of this manual.)

• Curve display mode selection (Single/Fine tuning/All Cond.)

• Mixing curve setting  
(For a description of the curve setting method, see the description at the back of this manual.)

## Setting method

- Touch the ACT button to set to ON.
- When setting a switch, touch the [NULL] button of the switch to call the <Switch> screen, and then select the switch and set its ON direction. (Always ON at "NULL" setting)  
(For a description of the switch selection method, see the description at the back of this manual.)
- When setting a VR, touch the Fine Tuning "NULL" button to call the <Switch> screen, and then select the VR. The adjustment rate and direction can be set. The VR operation mode can also be selected.
- A mixing curve can be set.  
(For a description of the curve setting method, see the description at the back of this manual.)
- The curve display mode can be changed.  
Single : Displays the mixing curve only  
Fine tuning : Displays the mixing rate of the fine tuning VR  
All Cond. : Displays the mixing curve of all the conditions. (When conditions are set)

### Fine tuning VR setting

- VR selection
- Rate adjustment
- Operation mode selection  
\*Displayed at VR setting.
- Adjustment direction setting

[Operation modes]

- Mixing rate 0% at center of VR  
When the VR is turned counterclockwise and clockwise, the mixing rate increases and decreases, respectively.
- Mixing rate 0% at left end of VR  
When the VR is turned, the mixing rate increases.
- Mixing rate 0% at right end of VR.  
When the VR is turned, the mixing rate increases.
- When the VR is turned to the left or right of the neutral position, the mixing rate increases.

## Airbrake to ELE

[Corresponding model type]: Airplane/glider, general

This mixing is used when you want to mix the elevators with airbrake (spoiler) operation. It raises the elevators to correct for drooping of the nose during airbrake operation.

\*This function does not operate when airbrake is not assigned at the Function menu in the Linkage Menu.

- The Rate 1 side/Rate 2 side mixing rate with the elevator servos can be adjusted.
- A mixing curve can be set.
- Mixing during flight can be turned ON/OFF by setting a switch. (Always ON at NULL setting)
- The mixing rate can be fine-tuned by setting a VR.

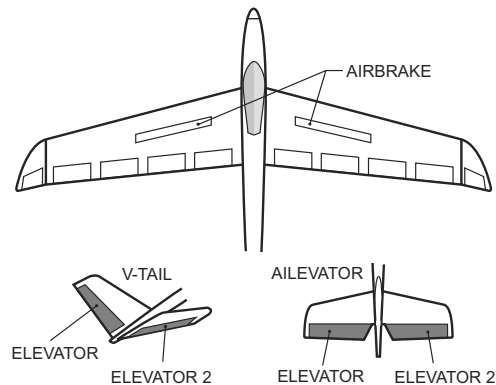

- Touch the [Airbrake to ELE] button in the Model Menu to call the setup screen shown below.

Annotations for the screenshot:

- Return to Model Menu
- Left/right overall adjustment by Rate A and Rate B
- Fine tuning VR setting
- Mixing curve setting (For a description of the curve setting method, see the description at the back of this manual.)
- Curve display mode switching (Single/Fine tuning/All Cond.)
- Group/single mode switch (Gr./Sngl) (For more information, see the description at the back of this manual.)

### Setting method

- Touch the "INH" button and set the function to ACT (ON).
- When setting a switch, touch the [NULL] button to call the <Switch> screen, and then select the switch and set its ON direction. (Always ON at "NULL" setting)  
(For a description of the switch selection method, see the description at the back of this manual.)
- When setting a VR, touch the Fine tuning "NULL" button to call the <Switch> screen, and then select the VR. The adjustment rate and direction can be set. The VR operation mode can also be set.  
(For a description of the fine tuning VR setting method, see the description at the back of this manual.)
- A mixing curve can be set.  
(For a description of the curve setting method, see the description at the back of this manual.)
- The curve display mode can be set.

Single : Displays the mixing curve only

Fine tuning : Displays the adjustment rate of the fine tuning VR

All Cond. : Displays the mixing curve of all the conditions. (When conditions are set)



# RUD to AIL

[Corresponding model type]: Airplane/glider, general

This function is used when you want to mix the ailerons with rudder operation. It is used when rudder is applied during roll maneuvers, knife edge, etc. of stunt planes. It can be used to bank scale models, large models, etc. like a full size plane.

- A mixing curve can be set.
- Mixing during flight can be turned ON/OFF by setting a switch. (Always ON at [NULL] setting)
- The rate of correction rudder can be memorized by using the memory function. This is convenient when setting a mixing curve. When memory operation (switch operation) is performed in the memory mode with correction rudder applied, the switch operation position at that time is displayed

- Touch the [RUD to AIL] button in the Model Menu to call the setup screen shown below.

on the mixing curve. When the memory mode is exited, the memorized points are automatically reflected on the curve. (When the memory function is used, "Line" type curve is automatically selected.)

- Linking can be set: Links this mixing to other mixings.
- The mixing rate can be fine-tune by setting a VR.

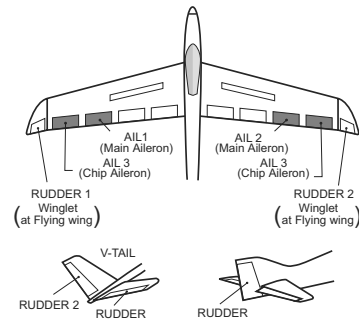

• Overall adjustment by Rate A and Rate B.

• When set to ON by touching [INH], the memory items are displayed.

(For a description of the curve setting method, see the description at the back of this manual.)

## Setting method

- Touch the "INH" button and set the function to ACT (ON).
- When setting a switch, touch the [NULL] button to call the <Switch> screen, and then select the switch and set its ON direction. (Always ON at "NULL" setting)  
(For a description of the switch selection method, see the description at the back of this manual.)
- When setting a VR, touch the Fine tuning "NULL" button to call the <Switch> screen and then select the VR. The adjustment rate and adjustment direction can be set.  
The VR operation mode can also be set.  
(For a description of the fine tuning VR setting method, see the description at the back of this manual.)
- A mixing curve can be set.  
(For a description of the curve setting method, see the description at the back of this manual.)
- The curve display mode can be changed.  
Single : Displays the mixing curve only  
Fine tuning : Displays the adjustment rate of the fine tuning VR

All Cond. : Displays the mixing curve of all the conditions. (When conditions are set)

- When linking: Touch the Link button and set it to ON.

### Memory function usage method

(Example) Using the memory function with an F3A airplane (knife edge correction)

\*When call switch ⇒[SW-A] and memory switch⇒ [SW-H] were set

[Memory function operation]

1. Memory function mode: [Manual]⇒[Memory]
2. When the memory switch (SW-H) was set to ON while performing aileron correction when rudder was applied at knife edge, the point position at that time is memorized. Perform memorization while changing the left and right stick positions.
3. To recall the memorized positions, set [SW-A] to ON. The memorized correction rate is reflected on the curve, and operation is simultaneously set.

Note: When memorized from manual before flight, be sure that the memory SW is not accidentally set to ON and incorrect mixing setting is not applied when taxiing, starting the engine, etc.

# Camber Mix

[Corresponding model type]: Airplane/glider, 2 ailerons or more

This function adjusts the AFR (D/R) rate of camber operation (ailerons, camber flaps, brake flaps) in the negative and positive directions. The aileron, flap, and elevator rates can also be adjusted independently by curve, and attitude changes can be corrected.

- Mixing during flight can be turned ON/OFF by setting a switch. (Always ON at NULL setting)
- A delay can be set for each condition. A cut switch which can turn OFF the delay function can be set.
- The speed of the aileron, flap, and elevator servos can be set. (IN side/OUT side)

- \*Initial setting assigns camber operation to side lever LST.
- The up/down side rates of the aileron, flap, and elevator servos can be adjusted by curve. When the mixing direction is reversed by the linkage, adjustments can be made by changing the mixing rate polarity.

- Touch the [Camber Mix] button in the Model Menu to call the setup screen shown below.

\*The display screen is an example. The actual screen depends on the model type.)

**Camber Mix** Model1 Condition 1 100%

ACT/INH INH Camber AFR

Group Gr. Curve and Rate

Switch NULL Aileron

Cond. Delay 0 Flap

Cut SW NULL Elevator

•Return to Model Menu

•Camber AFR (D/R) setup screen call (For a description of the setting method, refer to the AFR function.)

•Condition delay cut switch

•Condition delay setting

•Group/single mode switch (Gr./Sngl) (For more information, see the description at the back of this manual.)

•Aileron rate adjustment

(Curve/rate setup screen)

**Camber (AIL)** Model1 Condition 1 100% Return

	Rate 1	Rate 2
AIL	+0%	+0%
AIL2	+0%	+0%
AIL3	+0%	+0%
AIL4	+0%	+0%
In	0	0
Out	0	0

POS +0.0% RATE +0.0%

Linear	Separate
Rate A	Rate B
+100.0%	+100.0%
Offset	X offset
+0.0%	+0.0%

•Overall adjustment by Rate A and Rate B

•Servo speed setting (For a description of the setting method, see the description at the back of this manual.)

•Mixing curve setting (For a description of the curve setting method, see the description at the back of this manual.)

## Setting method

- Touch the "INH" button and set the function to ACT (ON).
- When setting a switch, touch the [NULL] button to call the <Switch> screen, and then select the switch and set its ON direction. (Always ON at "NULL" setting)  
(For a description of the switch selection method, see the description at the back of this manual.)
- When setting a condition delay, touch the Condition Delay button and set the delay with the adjustment buttons which appear on the screen. The VR operation mode can also be set.  
(For a description of condition delay, see the description at the back of this manual.)

## • Camber AFR(D/R) screen call

Touch the Camber AFR button to call the setup screen. (For a description of the setup method, see the description at the back of this manual.)

## (Curve/rate setup screen)

- The curve and rate are adjusted by calling the aileron, flap, and elevator curve/rate screens. The rate and curve of each servo can be set by calling each screen. (For a description of the curve setting method, see the description at the back of this manual.)  
The servo speed can also be adjusted.

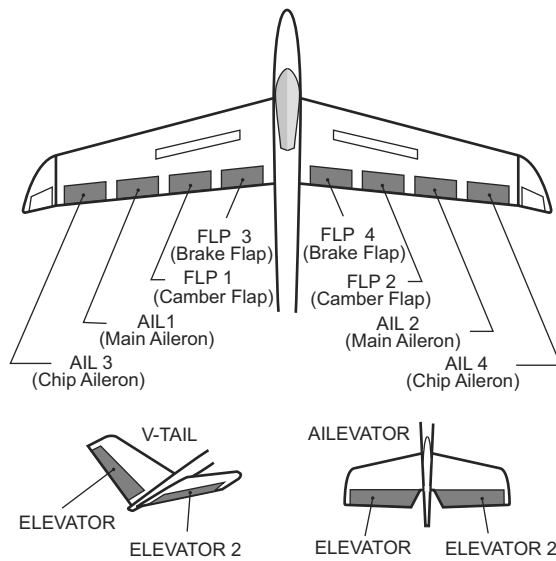

## ELE to Camber

[Corresponding model type]: Airplane/glider, 2 ailerons or more

This function is used when you want to mix the camber flaps with elevator operation. When mixing is used so that the flaps are lowered by up elevator, lift can be increased.

- A mixing curve can be set.
- Mixing during flight can be turned ON/OFF by setting a switch. (Always ON at NULL setting)
- The mixing rate can be fine-tuned by setting a VR.

- Touch the [ELE to Camber] button in the Model Menu to call the setup screen shown below.

- Group/single mode switching (Gr./Sngl)

(For more information, see the description at the back of this manual.)

- Curve display mode switching (Single/Fine tuning/All Cond.)

• Return to Model Menu

• Overall adjustment by Rate A and Rate B

• Fine tuning VR setting

• Mixing curve setting  
(For a description of the curve setting method, see the description at the back of this manual.)

	AIL3	AIL	AIL2	AIL4
Rate 1	+0%	+0%	+0%	+0%
Rate 2	+0%	+0%	+0%	+0%
	FLP3	FLP	FLP2	FLP4
Rate 1	+0%	+0%	+0%	+0%
Rate 2	+0%	+0%	+0%	+0%

(Ailerons and flaps rate adjustment screen)

### Setting method

- Touch the ACT button and set the function to ACT(ON).
- When setting a switch, touch the [NULL] button of the switch to call the <Switch> screen, and then select the switch and set its ON direction. (Always ON at "NULL" setting.)
- When setting a VR, touch the Fine tuning "NULL" button to call the <Switch> screen, and then select the VR. The adjustment rate and adjustment direction can be set. The VR operation mode can also be selected.

- A mixing curve can also be set.  
(For a description of the curve setting method, see the description at the back of this manual.)
- The curve display mode can be changed.  
Single : Displays the mixing curve only  
Fine tuning : Displays the fine tuning VR adjustment rate  
All Cond. : Displays the mixing curve of all the conditions (When conditions are set)

## Camber FLP to ELE

[Corresponding model type]: Airplane/glider, 2 ailerons + 1 flap or more

This mixing is used to correct changes (elevator direction) generated when the camber flaps (speed flaps) are used.

- The elevator servos up/down rate can be adjusted. When the mixing direction is reversed by the linkage, adjustments can be made by changing the mixing rate polarity.
- A mixing curve can be set.
- Mixing during flight can be turned ON/OFF by setting a switch. (Always ON at NULL setting)
- The mixing rate can be fine-tuned by setting a VR.

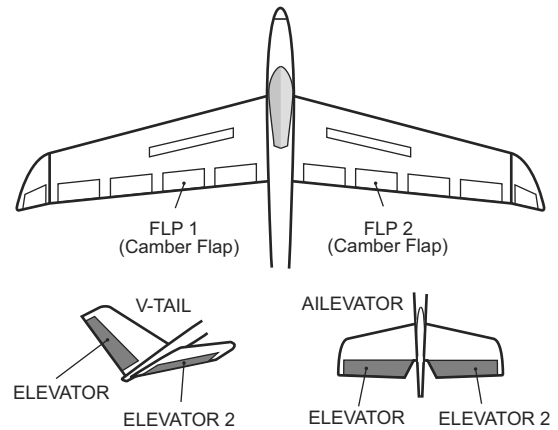

- Touch the [Camber FLP to ELE] button in the Model Menu to call the setup screen shown below.

\*The display screen is an example. The actual screen depends on the model type.

- Group/single mode switching (Gr./Sngl)  
(For more information, see the description at the back of this manual.)

### Setting method

- Touch the ACT button and set the function to ACT(ON).
- When setting a switch, touch the switch button to call the <Switch> screen, and then select the switch and set its ON direction. (Always ON at "NULL" setting)  
(For a description of the switch setting method, see the description at the back of the manual.)
- Touch the elevator servos left and right buttons and adjust the mixing rate with the adjustment buttons displayed on the screen.

\*When the mixing direction is reversed by the linkage, adjustments can be made by changing the mixing rate polarity.

- When setting a VR, touch the Fine tuning "NULL" button to call the <Switch> screen, and then select the VR.  
The VR operation mode can be selected.
- A mixing curve can be set.  
(For a description of the curve setting method, see the description at the back of this manual.)
- The curve operation mode can be changed.  
Single : Displays only the mixing curve  
Fine Tuning : Displays the adjustment rate of the fine tuning VR  
All Cond. : Displays the mixing curve of all the conditions (when conditions are set)

# Butterfly

[Corresponding model type]: Glider, 2 ailerons or more

This function allows powerful brake operation by simultaneously raising the left and right ailerons and lowering the flaps (camber flap, brake flap).

This setting will allow the ailerons to be raised while the flaps are simultaneously lowered. Butterfly (Crow) produces an extremely efficient landing configuration by accomplishing the following:

1. Slow the aircraft's velocity.
2. Provide washout at the wing tips to reduce the tendency to tip stall.
3. Create more lift toward the center of the wing allowing it to fly at a slower speed

- Touch the [Butterfly] button in the Model Menu to call the setup screen shown below.  
(The display screen is an example. The actual screen depends on the model type. The screen shown below is for 4 ailerons and 4 flaps.)
- Touch the ACT button and set the function to ACT (ON).
- When setting a switch, touch the SWITCH [NULL] button to call the <Switch> screen, and then select the switch and set its ON direction.

- Mixing during flight can be turned ON/OFF by setting a switch. (Always ON at NULL setting)
- The butterfly operation reference point can be offset. When the Offset button is touched when operated to the position to be changed, the reference point is offset. If the reference point is offset too much, unexpected operation may be performed.
- The ailerons, flaps, and elevators operation speed can be adjusted. (IN side/OUT side)
- A delay can be set for each condition. A cut switch which can turn OFF the delay function can also be set.
- The differential rate can be adjusted.

\*When servo binding occurs when setting the ailerons and flaps in butterfly mixing, use the AFR function to adjust the rudder angle.

- When setting the butterfly operation reference point, move the throttle stick to the point you want to change and then touch the Offset button. The reference point displays 0%. When touched, the reference point will change to the stick position.

- Group/single mode switching (Gr./Sngl)  
(For more information, see the description at the back of this manual.)

- Touch the Mixing Rate AIL and FLP buttons and adjust the mixing rates.

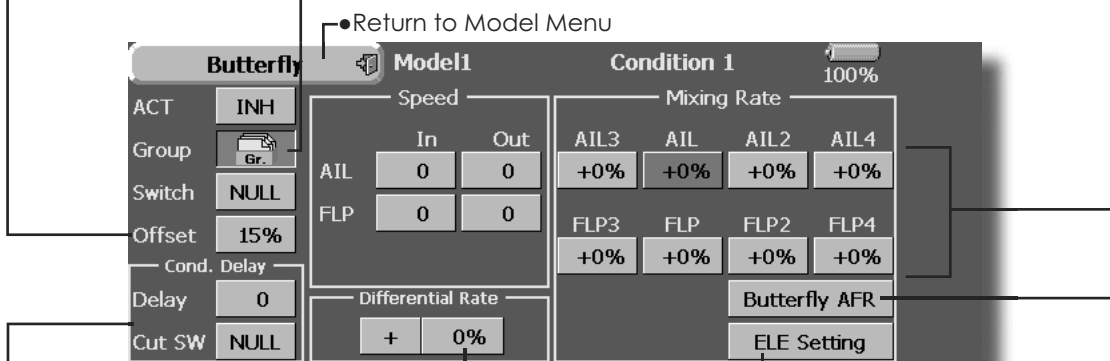

- Aileron and flap servos speed setting  
(For a description of the setting method, see the description at the back of this manual.)
- Condition delay setting and cut switch setting  
(For a description of the setting method, see the description at the back of this manual.)

Differential rate adjustment

To elevator correction setup screen

- Calls the Butterfly AFR (D/R) setup screen  
(For a description of the setting method, see the description at the back of this manual.)

- Touch the ELE correction rate buttons and adjust the rates with the adjustment buttons displayed on the screen.

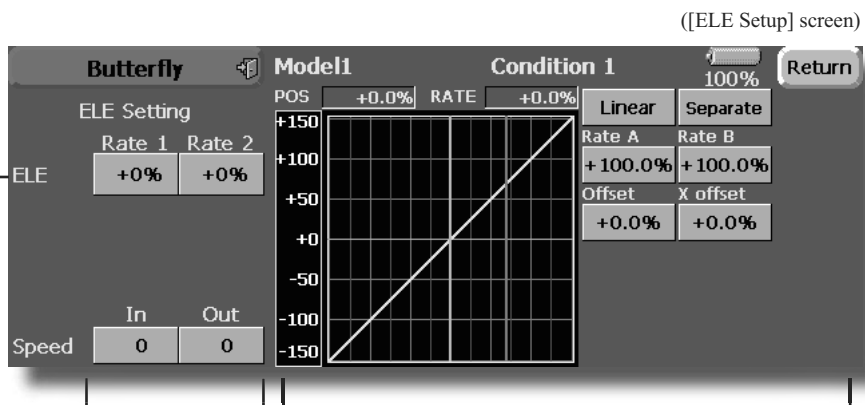

- Servo speed setting

(For a description of the setting method, see the description at the back of this manual.)

- Mixing curve setting

(For a description of the curve setting method, see the description at the back of this manual.)

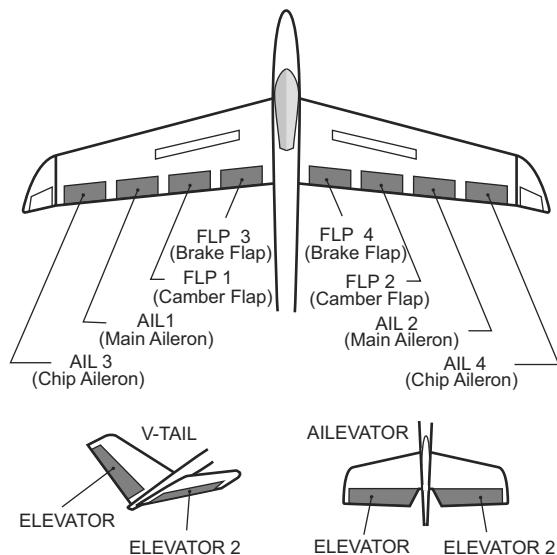

## Trim Mix 1/2

[Corresponding model type]: Glider, 2 ailerons or more

These functions call the ailerons, elevators, and flaps (camber flaps, brake flaps) trim offset rates preset according to the flight state.

The amount of ailerons, elevator, and flaps (camber flap, brake flap) trim offset can be set to a switch.

As an example **Trim Mix 1** can be set up for launching, with speed flaps and ailerons dropped, and a slight amount of up elevator. **Trim mix 2** can be used for high speed flying, with both ailerons and speed flaps reflexed slightly, and a bit of down elevator.

The trim functions can be activated during flight by setting a switch. To prevent sudden trim changes when switching flight conditions, a delay can be set to provide a smooth transition between the two. Trim Mix 2 will have priority over Trim Mix 1.

### Example

1. Touch the ACT button and set the trim mix function to [ON].  
\*When separating the settings for each condition, touch the group mode button and set it to [Sngl].
  2. Select the ON/OFF switch.
  3. Select the [Manual] or [Auto] mode.  
In the [Auto] mode, also select an auto SW. This switch can be linked to a stick, etc.
- <Speed>  
In: The operation speed at switch ON can be set.  
Out: The return speed at switch OFF can be set.
- <Fine Tuning>  
The offset rate can be varied in the Fine Tuning numeric range set at screen [1/2] by VR, etc. selection.
- <Condition Delay>  
When flight conditions are set, the operation speed can be set for each condition. Condition delay operation can be interrupted and each rudder quickly returned to its original position by selecting a cut switch.

- Touch the [Trim Mix 1] button in the Model Menu to call the setup screen shown below.

(The display screen is an example. The actual screen depends on the model type. The screen shown below is for 4 ailerons and 4 flaps.)

(Touch the [1/2] button to switch to page 2.)

- Touch the ACT button and set the function to ACT (ON).
- When setting a switch, touch the Switch button to call the <Switch> screen, and then select the switch and set its ON direction. (Always ON at "NULL" setting)

(For a description of the switch selection method, see the description at the back of this manual.)

- The ailerons, flaps, and elevators offset rate can be adjusted.

Touch the corresponding button and adjust the rate with the adjustment buttons displayed on the screen.

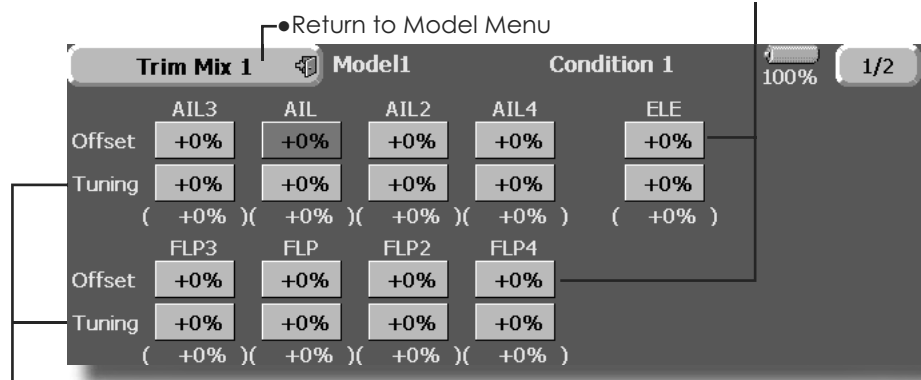

- When a fine tuning VR is set on the next page (2/2), the ailerons and flaps trim rates can be adjusted.

Touch the corresponding button and adjust the rate with the adjustment buttons displayed on the screen.



- Group/single mode switching (Gr./Sngl)  
(For more information, see the description at the back of this manual.)
- When using a fine tuning VR, touch this button to call the <Switch> screen.

• Return to Model Menu (Trim mix setup page 2/2)

Trim Mix 1		Model1		Condition 1	
ACT/INH	INH	Speed		Fine Tuning	
Group	Gr.	In	Out	Control	NULL
Switch	NULL	AIL	0 0		
Mode	Manual	FLP	0 0		
		ELE	0 0		
				Cond. Delay	
				Delay	0
				Cut Switch	NULL

- Ailerons, flaps, an elevators servo speed setting  
(For a description of the setting method, see the description at the back of this manual.)
- Condition delay setting (for a description of the setting method, see the description at the back of this manual) and cut switch setting.

- Manual/Auto mode selection  
Manual: Switches the function ON/OFF by switch  
Auto: Trim mix function call can be linked to a stick, etc. A stick switch, etc. separate from the function ON/OFF switch is set.

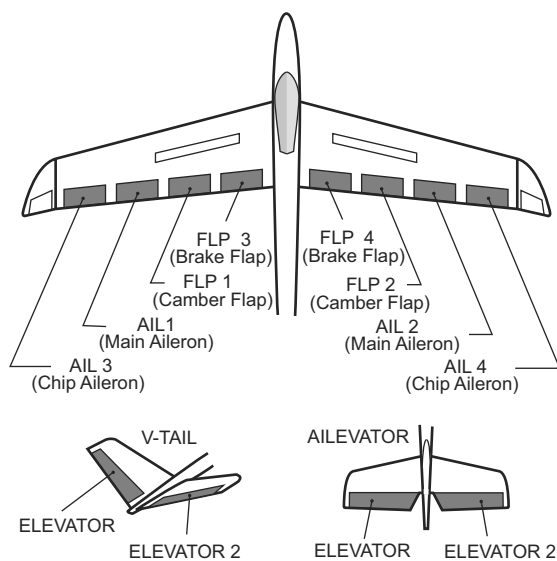

# Airbrake

[Corresponding model type]: Airplane, general

This function is used when an air brake is necessary when landing or diving, etc.

The preset elevators and flaps (camber flap, brake flap) offset amount can be activated by a switch.

The offset amount of the aileron, elevator, and flap servos can be adjusted as needed. Also the speed of the aileron, elevator, and flap servos can be adjusted. (IN side/OUT side) A delay can be set for each condition, and a Cut switch which will turn OFF the delay can be chosen. Trim amounts can be fine-tuned by setting a VR You can also set the Auto Mode, which will link Airbrake to a stick, switch, or dial. A separate stick switch or dial can also be set as the ON/OFF switch.

**Setting example for F3A and other flaperon specifications**

(When 2 ailerons model type selected)  
(Page 1/2)  
Offset rate:  
AIL: [-35~-45%], AIL2: [-35~-45%], ELE: [+5 | 7%]

Note: The input numerics are examples. Adjust the travel to match the fuselage.

(Screen 2/2)  
ACT: [ON]  
Group: [Sngl]  
Switch: [SC-C]  
Mode: [Manual]

- Touch the [Airbrake] button in the Model Menu to call the setup screen shown below. (The display screen is an example. The actual screen depends on the model type. The screen shown below is for 4 ailerons and 4 flaps.)

(Touch the [1/2] button to switch to page 2.)

- Touch the ACT button and set the function to ACT(ON).
- When setting a switch, touch the Switch button to call the <Switch> screen, and then select the switch and set its ON direction. (Always ON at "NULL" setting)

(For a description of the switch selection method, see the description at the back of this manual.)

- The aileron, flap, and elevator offset rates can be adjusted.  
Touch the corresponding button and adjust the rate with the adjustment buttons displayed on the screen.

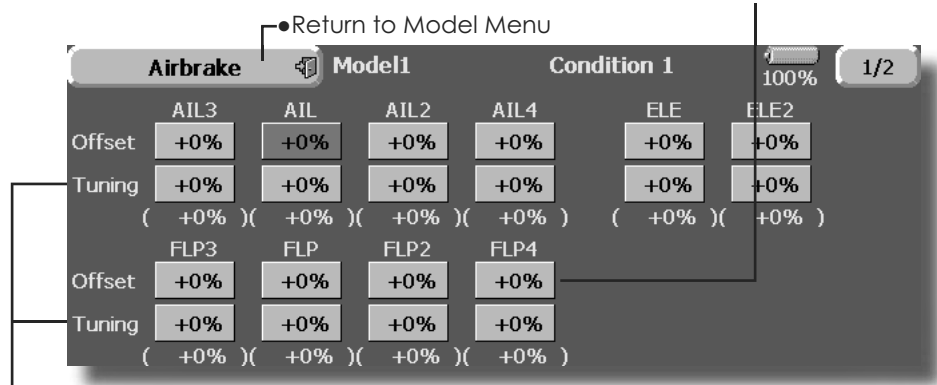

- When a fine tuning VR is set on the next screen (2/2), the aileron and flap trim rates can be adjusted. Touch the corresponding button and adjust the rates with the adjustment buttons displayed on the screen.

- Group/single mode switching (Gr./Sngl)  
(For more information, see the description at the back of this manual.)
- When using a fine tuning VR, touch this button to call the <Switch> screen.

Return to Model Menu (Airbrake setup screen 2/2)

Airbrake		Model1		Condition 1		100%	2/2
ACT/INH	INH	Speed		Fine Tuning			
Group	Gr.	In	Out	Control	NULL		
Switch	NULL	AIL	0	0			
Mode	Manual	FLP	0	0			
		ELE	0	0			
				Cond. Delay			
				Delay	0		
				Cut Switch	NULL		

- Ailerons, flaps, an elevators servo speed setting  
(For a description of the setting method, see the description at the back of this manual.)
- Condition delay setting (for a description of the setting method, see the description at the back of this manual) and cut switch setting.

- Manual/Auto mode selection  
Manual: Switches the function ON/OFF by switch  
Auto: Trim mix function call can be linked to a stick, etc. A stick switch, etc. separate from the function ON/OFF switch is set.

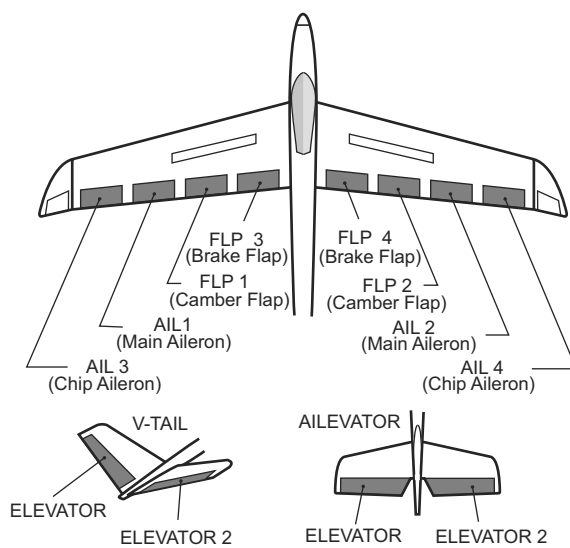

# Gyro

[Corresponding model type]: Airplane/glider, general

This function is used when a GYA Series gyro is used to stabilize the fuselage attitude. The sensitivity and operation mode (Normal mode/GY mode) can be changed with a switch.

- Three rates (Rate 1/Rate 2/Rate 3) can be switched.
  - Up to 3 axes (Gyro/Gyro 2/Gyro 3) can be simultaneously controlled.
- \*Initial setting does not assign a sensitivity channel. Use the

Function menu of the Linkage Menu to assign the sensitivity channel (Gyro/Gyro2/Gyro3) used to a vacant channel beforehand.

Set [ACT] and [Trim] other than Function to [NULL].

- Touch the [Gyro] button in the Model Menu to call the setup screen shown below.
- Group/single mode switching (Gr./Sngl)  
(For more information, see the description at the back of this manual.)

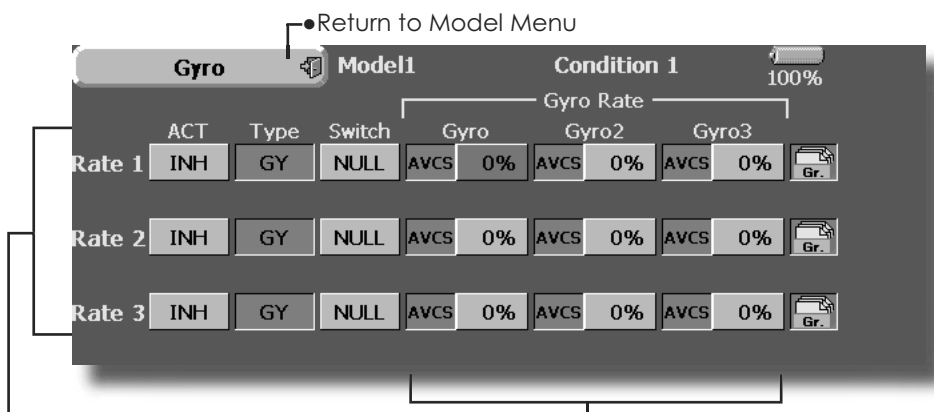

- The operation mode (AVCS/NOR) and sensitivity of the 3 axes Gyro/Gyro2/Gyro3 can be set.

- Three rates (Rate 1/Rate 2/Rate 3) can be used.
- Touch the ACT button of the rate to be used, and set the function to ACT ([ON] or [OFF]).
- When a Futaba GYA gyro is used, when [GY] type is selected, the sensitivity set value is directly read in both the AVCS and NOR modes.
- When setting a switch, touch the switch button to call the <Switch> screen, and then select the switch and set its ON direction.  
(For a description of the switch selection method, see the description at the end of this manual.)

### (Example) Setting 3 axes using a GYA351 and GYA352 (2 axes gyro)

- Wing type: Aileron 2 servos mounted fuselage selected
- Set Gyro 1 (GYA351): CH7, Gyro 2 (GYA352): CH8, Gyro 3 (GYA352): CH9 at the Function menu of the Linkage Menu.
- Rate 1 [OFF][GY][SW-E][NOR][60%][NOR][60%][NOR][60%][Gr]  
Rate 2 [INH][GY][NULL][AVCS][0%][AVCS][0%][AVCS][0%][Gr]  
Rate 3 [OFF][GY][SE-E][AVCS][60%][AVCS][60%][AVCS][60%][Gr]
- \*When separating the conditions, set to [Sngl].
- \*Set so that Rate 1 is turned on at the back position of switch E and Rate 3 is turned ON at the front position.
- Since switch E is turned OFF at the center, Rate 2 remains [INH].

## V-tail

[Corresponding model type]: Airplane/glider, V-tail

This function let's you adjust for left and right rudder angle changes during elevator and rudder operation of a V-tail airplane.

V-tail is when 2 servos are used together to control rudder movement as Elevators. In addition to each rudder side moving up and down together, each side moves in opposite directions when moving as Elevators. On a V-tail, this is also known as a Ruddervator, as they can serve the same purpose.

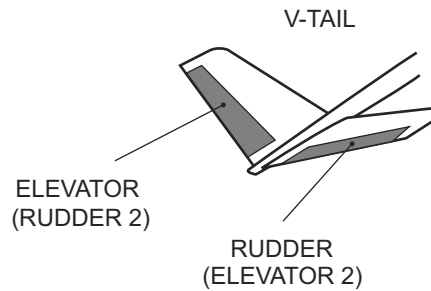

- Touch the [V-tail] button in the Model Menu to call the setup screen shown below.

- Group/single mode switching (Gr./Sngl)

(For more information, see the description at the back of this manual.)

Return to Model Menu

**V-Tail** Model1 Condition 1 100%

	Elevator Function		Rudder Function		Group
	Down	Up	Left	Right	
Elevator (Rudder2)	+50%	+50%	+50%	+50%	Gr.
Rudder (Elevator2)	+50%	+50%	+50%	+50%	
	+50%	+50%	+50%	+50%	
	+50%	+50%	+50%	+50%	

(Rudder function)  
Left and right travel adjustment at CH1 and CH2 rudder operation

(Elevator function)  
Up and down travel adjustment at CH1 and CH2 elevator operation

## Ailevator [Corresponding model type]: Airplane/glider, V-Tail (Effective only when 2 servos used at the elevators)

This function improves the operating performance of the roll axis by operating the elevators as ailerons.

Ailevator is where each elevator in a standard (conventional) or v-tail moves independently, like ailerons on a wing. In addition to each elevator side moving up and down together, each side moves in opposite directions when moving as an Ailevator. On a V-tail, this is also known as a Ruddervator, as they can serve the same purpose. Typically, both Ailevator and ailerons are coupled together to maximize roll performance, especially on larger wingspan planes..

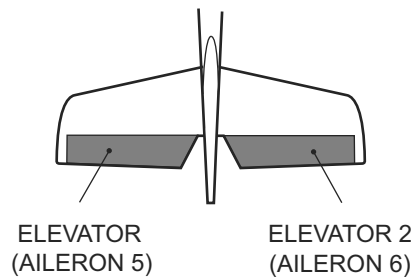

Note: Select Ailevator as the Model Type at the Model Type screen. This changes the output channel. Check the Function menu.

- Touch the [AIL] button in the Model Menu to call the setup screen shown below.

- Group/single mode switching (Gr./Sngl)

(For more information, see the description at the back of this manual.)

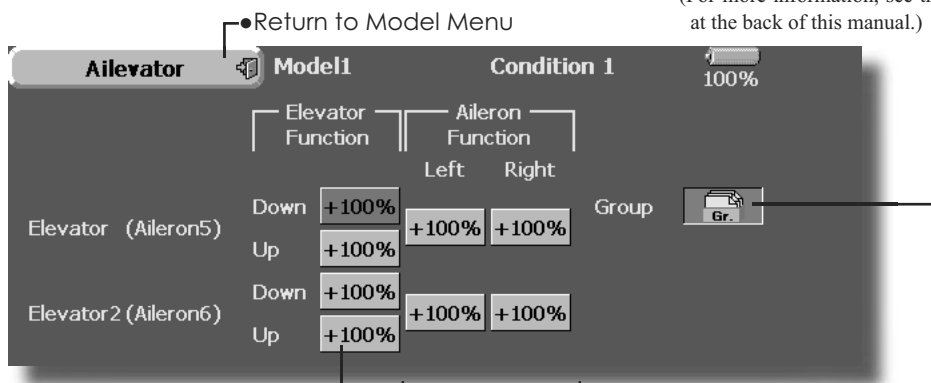

(Aileron function)

- When the elevators are used as ailerons, aileron travel of the left and right elevators can be adjusted.

(Elevator function)

- The up and down rate of the left and right elevators when the elevator stick is manipulated can be individually adjusted.

# Winglet

[Corresponding model type]: Airplane/glider, winglet

This function adjusts the rubber left and right rudder angle of winglet specifications fuselages.

Winglets are used to improve the efficiency of aircraft lowering the lift-induced drag caused by wingtip vortices. The winglet is a vertical or angled extension at the tips of each wing.

Winglets work by increasing the effective aspect ratio wing without adding greatly to the structural stress and hence necessary weight of its structure - an extension of wing span would also permit lowering of induced drag, though it would cause parasitic drag and would require boosting the strength of the wing and hence its weight - there would come a point at which no overall useful saving would be made. A winglet helps to solve this by effectively increasing the aspect ratio without adding to the span of the wing.

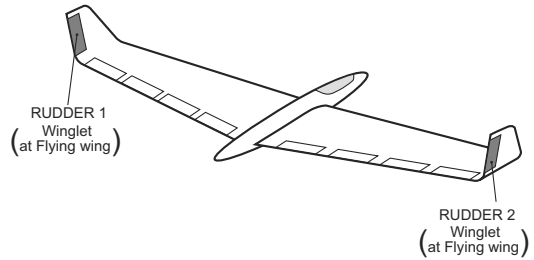

- Touch the [Winglet] button in the Model Menu to call the setup screen shown below.

- Group/single mode switching (Gr./Sngl)

(For more information, see the description at the back of this manual.)

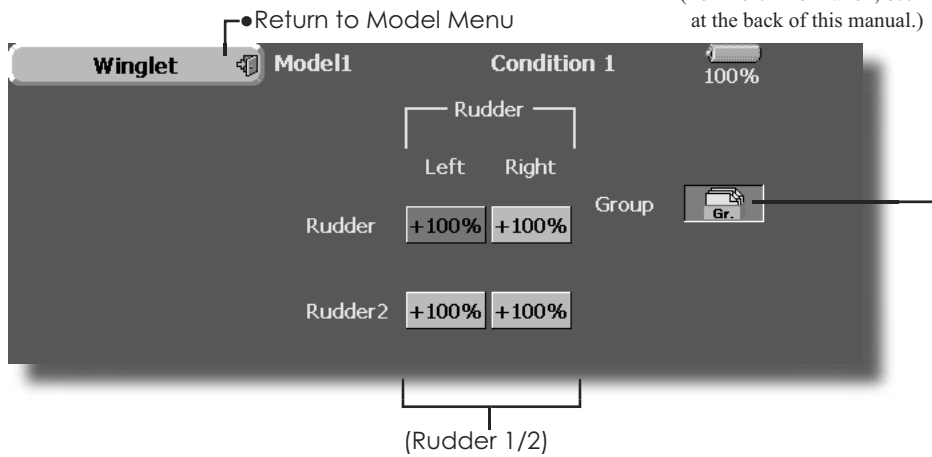

- The travel at rudder stick left and right operation can be individually set.

This function lets you set the operation speed when the motor of a F5B or other EP glider is started by switch. The operation speed can be set in 2 ranges of slow speed flight and high speed flight (Speed 1/Speed 2). This function can also be operated as a safety function by setting 2 switches.

- The In side and Out side operating speeds can be adjusted independently in 2 ranges (Speed 1/Speed 2).
- The boundary between the 2 ranges can be set. (From Speed 1 to Speed 2)
- The set operation speed operation can be activated at initial operation only. (1 time operation) However, operation can be repeated

by setting the switch to OFF before operation is finished. When you want to reset 1 time operation, set the ACT button to [INH] and then reset it to [ON].

- The motor (CH3) is controlled by SW-G. (Initial setting) When changing the switch or stick which controls the motor, first change Function of the Linkage Menu.

**Note: When using this function, always check initial operation with the propeller removed.**

- Touch the [Motor] button in the Model Menu to call the setup screen shown below.

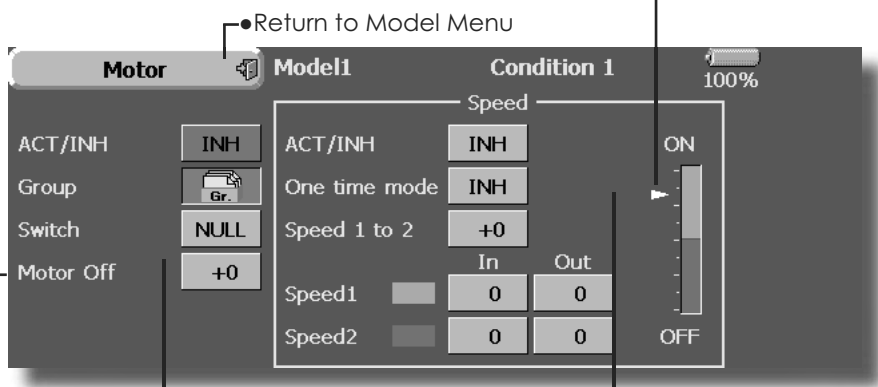

- Move the cursor by set switch or VR.

- Operation  
Touch the button and set the function to ON.
- Group/single mode switching (Gr./Sngl)  
(For more information, see the description at the back of this manual.)
- Switch  
A switch that turns the function itself ON/OFF can be selected.
- Motor off  
[Yes] and [No] are displayed by touching the Motor Off button when [SW-G] is in the motor OFF position. When [Yes] is touched, the direction of the motor switch is memorized. The screen graph display ON direction also changes.

- Operation  
Touch the button and set the function to ON.
- When you want to set the "One time mode", touch the button and set the mode to [ON].
- Speed 1 to 2  
The Speed 1 and Speed 2 region boundary can be changed,
- Operation speed adjustment  
The speed when Speed 1 and Speed 2 are ON (In) and OFF (Out) can be adjusted.

**Notes**

- First decide the motor OFF point, and then set the speed. When you want to reset the motor OFF point, also reset the speed.
- We recommend that Motor OFF be set in combination with F/S.
- Set the basic operation direction with the Reverse function to match the amp used.
- Always set the Motor OFF position.



## RUD to ELE

[Corresponding model type]: Airplane, general

This function is used when you want to mix elevator with rudder operation. It is used to correct undesirable tendencies when rudder is applied in roll maneuvers, knife edge, etc. of stunt planes.

- A mixing curve can be set.
- Mixing during flight can be turned ON/OFF by setting a switch. (Always ON at NULL setting)
- The amount of correction rudder can be memorized by using the Memory function. This is convenient at mixing curve setting. When memory

operation (switch operation) is performed with correction rudder applied in the Memory Mode, the stick position at that time is displayed on the mixing curve. The point is automatically reflected in the curve. (When the Memory function is used, "Line" is automatically selected as the curve type.)

- Link can be set: Links this mixing to other mixings.
- The mixing rate can be fine-tuned by setting a VR. (Fine tuning)

- Touch the [RUD to ELE] button in the Model Menu to call the setup screen shown below.

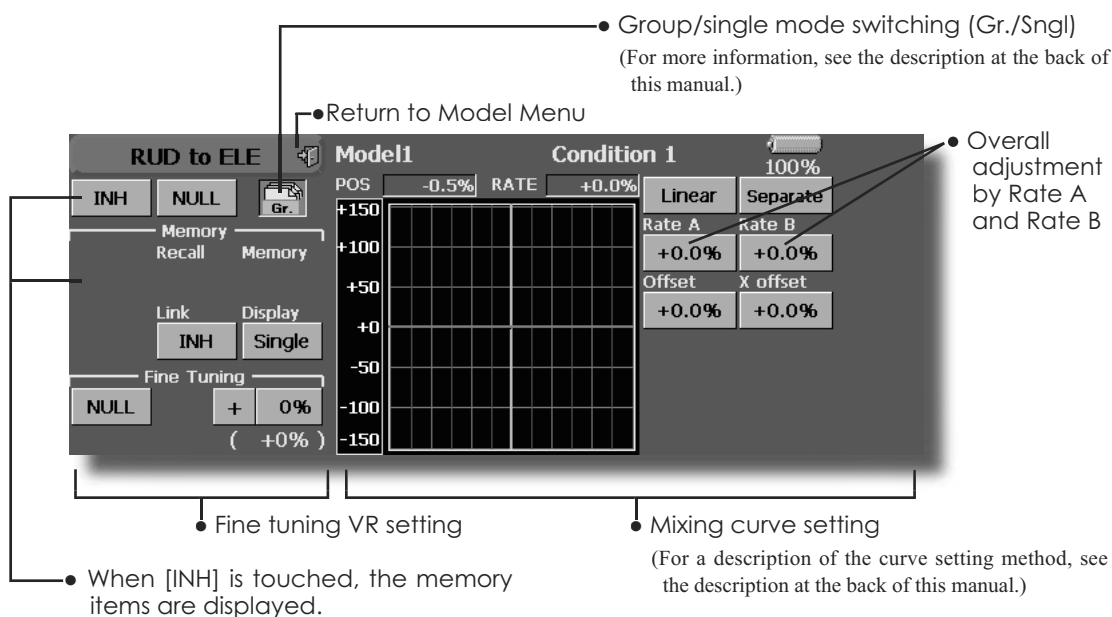

### Setting method

- Touch the "INH" button, and set the function to ACT(ON).
- When setting a switch, touch the "NULL" button to call the <Switch> screen, and then select the switch and set its ON direction. (Always ON at "NULL" setting)  
(For a description of the switch setting method, see the description at the back of this manual.)
- When setting a VR, touch the Fine Tuning "NULL" button to call the <Switch> screen, and then select the VR. The fine tuning rate and adjustment direction can be set.  
The VR operation mode can also be set.  
(For a description of the fine tuning VR setting method, see the description at the back of this manual.)
- The curve display mode can be changed.  
Single : Displays the mixing curve only  
Fine Tuning : Displays the fine tuning rate of the fine tuning VR  
All Cond. : Displays the mixing curve of all the conditions (When conditions are set)
- When setting Link, touch the Link button and set it to ON.

### Memory function usage method

(Example) Using the memory function with an F3A airplane (knife edge correction)

\*When call switch ⇒[SW-A] and memory switch⇒[SW-H] were set

[Memory function operation]

1. Memory function mode: [Manual]⇒[Memory]
2. When the memory switch (SW-H) is set to ON while performing elevator correction when rudder was applied at knife edge, the point position at that time is memorized. Memorization is performed while changing the left and right stick positions.
3. To recall the memorized positions, set [SW-A] to ON. The memorized correction rate is reflected on the curve, and operation is simultaneously set.

Note: When memorized from manual before flight, be sure that the memory SW is not accidentally set to ON and incorrect mixing setting is not applied when taxiing, starting the engine, etc.

# Snap Roll

[Corresponding model type]: Airplane, general

This function selects the switch and rate adjustment of rudder, ailerons, elevators, or flaps when a snap roll is performed.

- Four snap roll directions can be set. (Right/up, right/down, left/up, left/down)
- Operation mode: When [Master] mode is selected, the Snap Roll function is turned ON/OFF by master switch in the state in which the direction switch was switched to the direction in which you want to snap roll. When [Single] mode is selected, snap roll in each direction can be executed by means of independent switches.
- A safety switch can be set. As a safety measure, the switch can be set so that snap roll is not executed when, for instance, the landing gear is lowered, even if the switch is turned on accidentally. The snap roll switch is activated only when the safety switch is ON.
- The operation speed of the aileron, elevator, and flap servos can be adjusted for each snap roll direction. (In side/Out side) (Page 2/2)

## (Example) Setting example for F3A

- Mode: [Master]
- Safety SW: [SW-G] (Safety measure)
- Master SW: [SW-H] (Main switch for executing snap roll)
- Direction switches:
  - \*The snap roll up side left and right and down side left and right direction switches are selected here.
  - Right/Up: OFF [SW-D]
  - Right/Down: OFF [SW-D]
  - Left/Up: OFF [SW-A]
  - Left/Down: OFF [SW-A]
- Speed adjustment (Screen 2/2)
  - The operation speed of each control surface when the snap switch is ON can be changed and snap roll executed by stick while there is switch operation can be performed.
- Touch the [Snap Roll] button in the Model Menu to call the setup screen shown below.

- Curve display mode switching (Single/Fine tuning/All Cond.)

Return to Model Menu

	ACT	Switch	Rate		
			AIL	ELE	RUD
Right / Up	OFF	NULL	+100%	+100%	+100%
Right / Down	OFF	NULL	+100%	-100%	-100%
Left / Up	OFF	NULL	-100%	+100%	-100%
Left / Down	OFF	NULL	-100%	-100%	+100%

- Group/single mode switching (Gr./Sngl)  
(For more information, see the description at the back of this manual.)

- Direction switches

- Rate adjustment of each rudder

Speed

	AIL		ELE		RUD	
	In	Out	In	Out	In	Out
Right / Up	0	0	0	0	0	0
Right / Down	0	0	0	0	0	0
Left / Up	0	0	0	0	0	0
Left / Down	0	0	0	0	0	0

- Adjustment of the servo speed of each rudder  
(For a description of the setting method, see the description at the back of this manual.)

# Multi Engine

[Corresponding model type]: Airplane, general

This function lets you adjust the throttle when using a multi engine airplane with up to 4 engines. The Throttle Cut function, Idle Down function, Throttle Hold function, High Trim, and Idle Trim can be adjusted by throttle channel (THR, THR2, THR3, THR4).

\*Initial setting assigns only one throttle channel (THR). When using this function, the number of throttle channels must be assigned beforehand at the Function menu of the Linkage Menu.

- The throttle cut position can be set for each throttle channel. Throttle cut operation is linked to the switch set with the Throttle Cut function of the Linkage Menu.

\*The throttle cut position set at this screen is effective.

- The throttle down offset rate can be set for each throttle channel. Idle down operation is linked to the switch set with the Idle Down function of the Linkage Menu.

\*The idle down offset rate set at this screen is effective.

- Operation can be fixed at the engine speed (carburetor opening angle) for each throttle channel with the Hold Position function. The hold position can be changed.

- High side trim and idle trim can be set for each channel. Operation acts as high trim or idle trim based on the center.

- Touch the [Multi Engine] button in the Model Menu to call the setup screen shown below.

\*The number of engines (1~4) assigned by Function menu in the Linkage Menu setup screen is displayed.

• Return to Model Menu

		THR	THR2	THR3	THR4	
ACT/INH		INH	INH	INH	INH	
Throttle Cut	ACT	INH	INH	INH	INH	
	Posi.	17%	17%	17%	17%	
Idle Down	ACT	INH	INH	INH	INH	
	Rate	17%	17%	17%	17%	Hold Pos.
Throttle Hold		INH	INH	INH	INH	17%

- Throttle cut position setting (for each engine)
- Idle down offset rate setting (for each engine)
- Throttle hold position setting

		THR	THR2	THR3	THR4	
High Trim	Control	NULL	NULL	NULL	NULL	
	Rate	+ 0% ( +0% )	+ 0% ( +0% )	+ 0% ( +0% )	+ 0% ( +0% )	
Idle Trim	Control	NULL	NULL	NULL	NULL	
	Rate	+ 0% ( +0% )	+ 0% ( +0% )	+ 0% ( +0% )	+ 0% ( +0% )	

- High Trim setting (for each engine)
- Idle Trim setting (for each engine)

## MODEL MENU (HELICOPTER)

This section contains information on the commands that apply to helicopters only. For instructions on Airplanes and Sailplanes, refer to the sections pertaining to those aircraft. Each of these functions can be set independently for different flight conditions. To get to these settings, touch the desired function button to be entered.

Use the Model Type function in the Linkage Menu to select the swash type matched to the

helicopter beforehand. If you later change model types, all settings will be lost.

Also, add flight conditions at the Condition Select screen before setting the model data at each function. (Up to 8 conditions can be used)

The AFR function, fuel mixture and other functions common to all model types, are described in a separate section.

- Touch the Model Menu button of the Home screen to call the menu shown below. Touch the button of the function you want to set to call the setup screen.

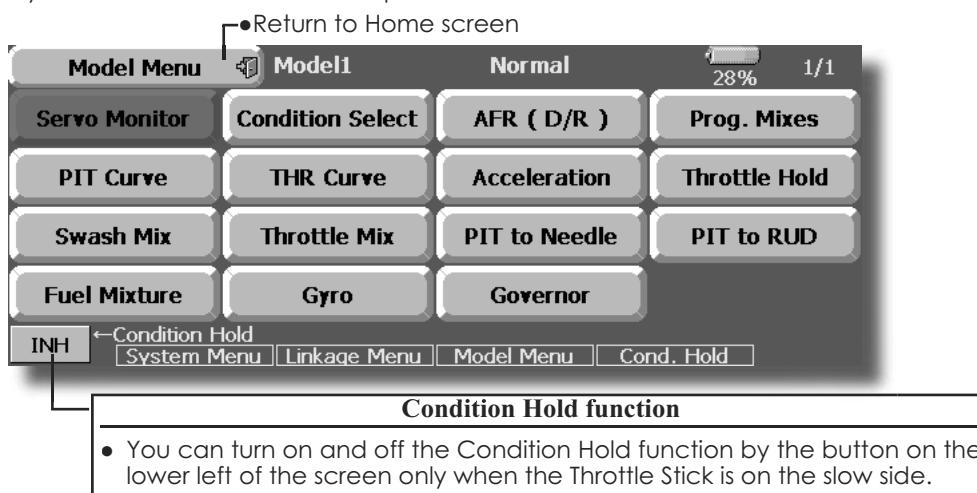

### Model Menu functions (helicopter) list

**PIT Curve:** Adjusts response in different flight conditions

**THR Curve:** Throttle curve and hovering trim adjustment

**Acceleration:** Counteracts torque due to sudden throttle and pitch commands

**Throttle Hold:** Moves the throttle to idle during autorotation

**Swash Mix:** Compensates for each control response

**Throttle Mix:** Compensates for power loss when cyclic applied

**Pit to Needle:** Adjusts response curve in different flight conditions

**Pit to RUD:** Handles torque changes from pitch angle inputs

**Fuel Mixture:** Commands a second servo to adjust the fuel mixture at the carburetor

**Gyro:** Used to switch gyro sensitivity

**Governor:** Used to switch RPM of the helicopter's head

# PIT Curve/Pitch Trim

## PIT Curve

This function adjusts the pitch operation curve for each flight condition for the optimal flight state relative to movement of the throttle stick.

The pitch curve can be freely selected from linear operation curve to smooth curve, and adjusted to match the curve you want by means of the FX-40's powerful Curve Edit Function (6 types of curves can be selected). Up to 17 points can be set for linear or curve types. However, when using

the 3 points or 5 points specified to create a curve, a simple and smooth curve can be created by selecting the curve type and reducing the number of input points to 3 or 5, and then entering the specified value at the corresponding points that you created. a curve, a simple and smooth curve can be created by selecting the curve type and reducing the number of input points to 3 or 5, and then entering the specified value at the corresponding points that you created.

- Touch the [PIT Curve] button in the Model Menu to call the setup screen shown below.
- There are 4 types of display. The curve of all the conditions or the pitch and throttle curves can be displayed on one screen.

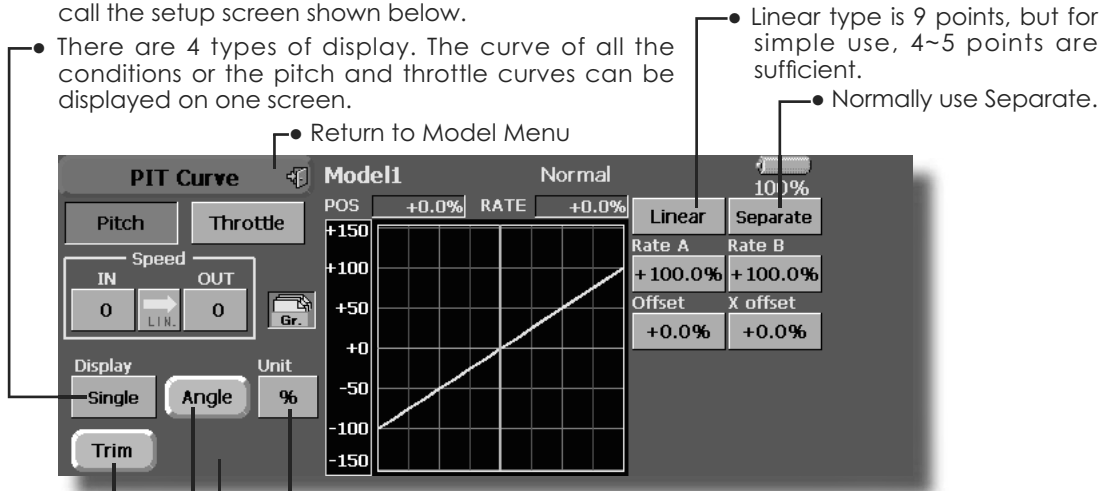

- Linear type is 9 points, but for simple use, 4~5 points are sufficient.
- Normally use Separate.
- Return to Model Menu
- Trim can be used as hovering pitch and pitch trim. The high and low side pitch can be fine-tuned.
- Units can be selected from [%] and [Deg]. When [Deg] is selected, the rotor pitch angle is displayed and becomes the setting standard. When [Deg] was selected, the high, center, and low pitch angles are entered.
- Can be copied to the pitch trim adjustment position.
- When the [Angle] button is touched, the pitch angle input screen is displayed. Input the maximum pitch, center, and low pitch.

### Normal curve adjustment

- For normal curve, usually use [Line] type and create a basic pitch curve centered about hovering. Use this function together with the THR Curve (Normal) function and adjust the curve so that up/down control is best at a constant engine speed.

### Idle up curve adjustment

- For the high side pitch curve, set the maximum pitch which does not apply a load to the engine. For the low side pitch curve, create curves matched to loop, roll, 3D, and other purposes and use the idle up curves according to the performance.

Note: When the curve type is changed, the data is reset.

### Throttle hold curve adjustment

- The throttle hold curve is used when executing auto rotation dives.

### Operation precautions

#### ⚠ WARNING

- When actually starting the engine and flying, always set the idle up condition switch to [OFF] and start the engine in the idling state.

## Setting method

- Group button: When you also want to enter the same settings to other conditions, set in the group mode (initial setting). In this case, the same contents are entered to the other conditions set in the group mode. When you want to set each condition independently, select the single mode.
- Normal % input or angle input can be selected at rate adjustment at curve setting. For angle input, if the high side, low side, and center angles are entered beforehand, the rate can be set by reading the angle directly (standard).
- The curve graph display mode can be selected. This is convenient when checking curves other than the curve currently being set.  
[Sngl]: Displays only the curve currently being set  
[Fine Tuning]: When pitch trim is used, a curve with pitch trim adjustment added is also displayed.

[All Cond.]: Displays the pitch curve of all the conditions. The curve of the condition currently in use is indicated by a bold line.

PIT&THR: The throttle hold curve of the condition currently in use is also displayed.

- The Throttle Curve setup screen can be called with one touch, which is convenient when making adjustments alternately with the throttle curve.
- The servo operation speed can be set. When adjusted when the pitch is too sensitive, the pitch operation feeling can be changed.
- When increasing the number of points, use the cursor keys [<][>] to move the cursor to the point where you want to enter a point (■) and touch the Rate button. The point is created.

## Curve setting examples

The screens shown below are curves created by entering the pitch angle at low, center, and high side 3 points or 5 points at each condition. They were created by reducing the number of points to the 3 points of low side, center, and high side. When actually creating a curve, input the angle specified

by the helicopter (or the reference value).

\*For a description of the curve setting method, see the description at the back of this manual.

### •Pitch Curve (Example)

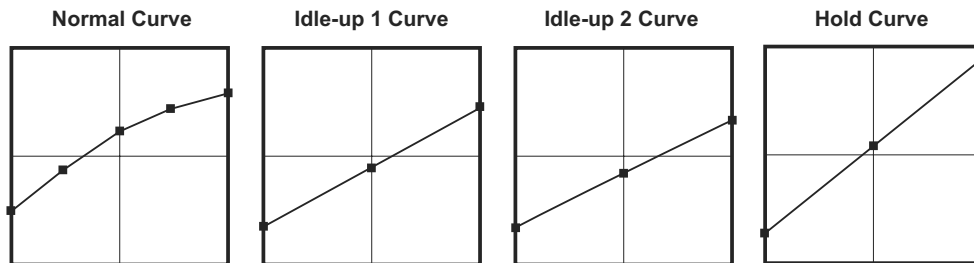

## Pitch Trim (Hovering pitch, high pitch, low pitch)

The hovering pitch, low pitch, and high pitch trim setup screen can be called from the PIT Curve setup screen.

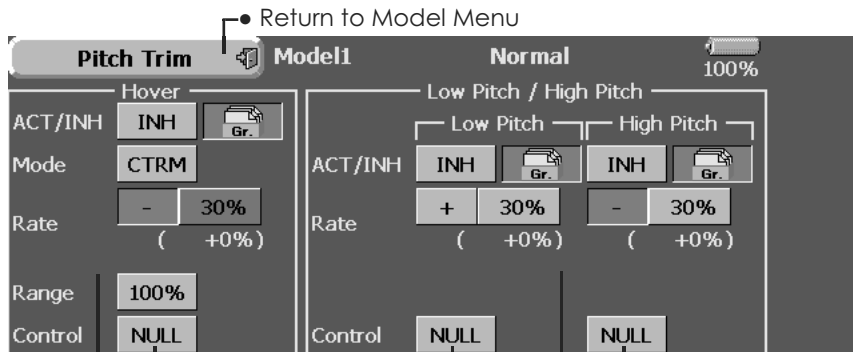

• Hovering pitch trim setting

• Low/High pitch trim

• Adjusts the adjusting dial.

(Continued on next page)

---

### **Hovering pitch trim**

---

The Hovering Pitch function trims the pitch near the hovering point. Normally, it is used with the hovering condition. The hovering pitch can be fine tuned for changes in rotor speed accompanying changes in temperature, humidity, and other flight conditions. Adjust the hovering pitch so that rotor speed is constant. This function can be used together with the Hovering Throttle Trim function for more delicate operation.

#### **Setting method**

---

- When using only the hovering (normal) condition, switch the group button to the single mode before setting.
- Set the function to ACT [ON].
- Select the adjustment knob. Selection example: LD or T6
- The trim operation mode (Mode: CTRM/NORM) can be selected.

**CTRM mode:** Maximum amount of change near center by center trim operation

**NORM mode:** Normal trim (parallel movement trim) operation. The advantage of using this mode is that the hovering pitch can be adjusted without changing the curve.

- Trim adjustment range (Range) setting  
When this value is made small, trim can only be used near the center.
- The trim rate can be adjusted and the operation direction can be changed.

### **High Pitch/Low Pitch Trim**

---

High Pitch/Low Pitch Trim is the pitch servo high side and low side trim function.

#### **Setting method**

---

- When setting the adjustment knobs common to all the conditions, set them in the group mode.
- Set the function to ACT (ON).
- Select the adjustment knobs. Selection example: LST (high side), RST (low side)
- The trim rate can be adjusted and the operation direction can be changed.
- Trim acts as high side or low side trim with the center as the standard.

## THR Curve/Throttle Hover trim

### THR Curve

This function adjusts the throttle operation curve for each condition for optimum the engine speed per throttle stick movement.

A throttle curve from linear operation curve to smooth curve can be set. Adjustment to the curve you want to use is possible by using the 14MZ's powerful Curve Edit Function. Up to 17 curve

points can be set, however, when the 5 points and other point data is used, a smooth curve can be easily created by reducing the number of input points of the curve to 5 and entering the specified value at the corresponding points.

- Touch the [THR Curve] button in the Model Menu to call the setup screen shown below.

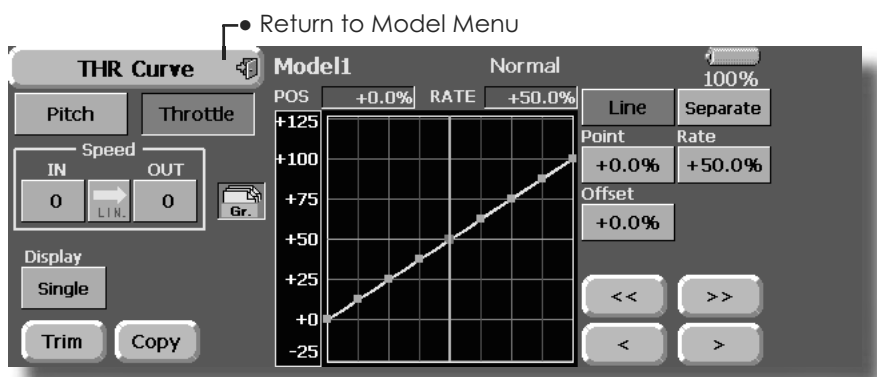

### Normal curve adjustment

- Normal curve creates a basic curve centered around hovering. Use it along with the normal pitch curve and adjust so that up/down control at a constant engine speed is easiest.

### Idle up curve adjustment

- Set a normal up curve that maintains a constant speed at all times, even when operation which reduces the pitch was performed in flight. Create a curve matched to loop, roll, 3D, or other purposes and the idle up curve according to the performance.

### Setting method

- Group button: When you want to simultaneously enter the same settings to other functions, make the settings in the group mode. (Initial setting) In this case, the same setting contents are entered to the other conditions in the group mode. When you want to set each condition independently, make the settings after selecting the single mode.
- The curve graph display mode can be selected. This is convenient when checking curves other than the one being set.  
[Sngl]: Displays only the curve being set.  
[Fine Tuning]: When Throttle Hover trim is used, a curve with trim adjustment added is also

### Operation precautions

#### ⚠ WARNING

- ! When actually starting the engine and flying, always set the Idle up Condition switch to [OFF] and start the engine in the idling mode.

displayed.

[All Cond.]: Displays the throttle curve of all the conditions. The curve of the condition currently in use is indicated by a bold line.

[PIT&THR]: The pitch curve of the condition currently in use is also displayed.

- The pitch curve setup screen can be called with one touch. This is convenient when alternately adjusting these curves with the pitch curve.
- The servo speed can be set. Adjust the throttle speed when the throttle is too sensitive



## Curve setting examples

The curves shown below were created by using the Line mode and entering the data of the 5 points 0% (low side), 25%, 50% (center), 75%, 100% (high) side at each condition. They were created by reducing the number points of the line to 5. When

actually creating a curve, enter the data specified per the fuselage (or the reference value).

\*For a description of the curve creation method, see the description at the back of this manual.

### •Throttle Curve (Example)

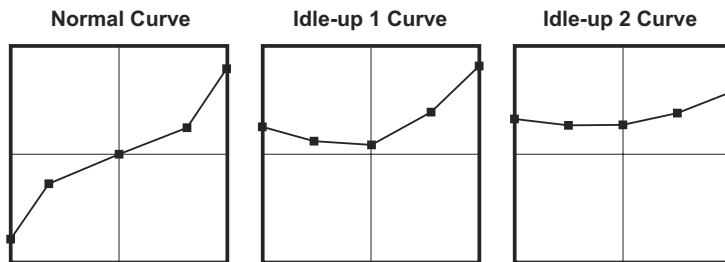

## Throttle Hover trim

The Throttle Hover trim setup screen can be called from the THR Curve setup screen.

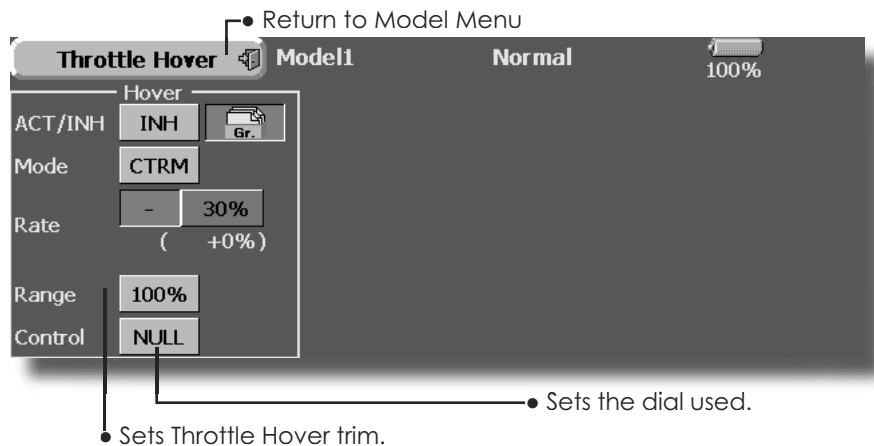

The Throttle Hover function trims the throttle near the hovering point. Normally, use it with hovering conditions. Changes in rotor speed accompanying changes in the temperature, humidity, and other flight conditions can be trimmed. Adjust the throttle so that rotor rotation is most stable. More delicate trimming is also possible by using this function along with the Hover Pitch function.

### Setting method

- When using the hovering (normal) condition only, switch the [Gr.](group button) mode to the [Sngl](single) mode and make the settings.
- Set the function to ACT ([ON]).
- Select the adjustment knob. Selection example: RD
- The trim operation mode (Mode: CTRM/NORM)

can be selected.

**CTRM mode:** Maximum rate of change near center by center trim operation

**NORM mode:** Normal trim (horizontal movement trim) operation. The advantage of using this mode is that hovering throttle can be adjusted without changing the curve.

- Trim adjustment range (Range) setting  
When the value is made small, trim acts only near the center.
- The trim rate can be adjusted and the operation direction can be set.

## Acceleration Mixing

This function is used to adjust the pitch and the throttle at acceleration/deceleration. An acceleration function which temporarily increases the pitch and throttle operations at throttle stick acceleration/deceleration operation can be set.

### Example of acceleration function use

- When used at pitch, the Acceleration function is effective when you want to quicken the response of the helicopter at 3D flight flip, etc.

When used, high pitch temporarily exceeds maximum pitch, but immediately returns to maximum pitch.

Using Acceleration with Pitch is effective when you want to maximize speed for 3D aerobatics and other aircraft responses. As an example, "High pitch" temporarily overrides "maximum pitch" and immediately returns to the maximum pitch position.

- Touch the [Acceleration] button in the Model Menu to call the setup screen shown below.

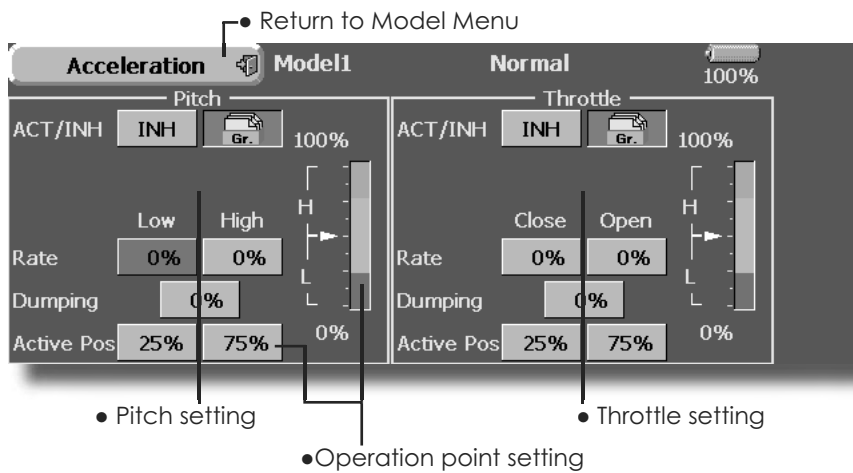

### Setting method

- Acceleration can be set at both setting at acceleration (high) and setting at deceleration (low).  
(The operation point is displayed on a graph.)
- Acceleration rate setting (Rate)
- The return time after operation (Dumping) can be set.
- The operation point at acceleration and deceleration can be set. When an operation point is exceeded, acceleration is performed.

**Note:** When using the Acceleration function, since the pitch stroke is large, make your settings so there is no binding of your linkage.

## Throttle Hold

This function sets the throttle cut position at auto rotation. The throttle position can also be set to an idling position separate from the throttle cut position. Setting of these 2 positions can be selected by switch. This allows use for switching during training.

### Example of use

- Since Throttle Hold has 2 modes (Cut) and (Idle), using it in the Idling mode during training and in the Cut mode when stopping the engine at meets, etc. is convenient.

Note: When throttle hold is set to ON in the normal condition, throttle hold acts and the throttle servo is deactivated. Always set throttle hold to ON in the hold condition.

- Touch the [Throttle Hold] button in the Model Menu to call the setup screen shown below.

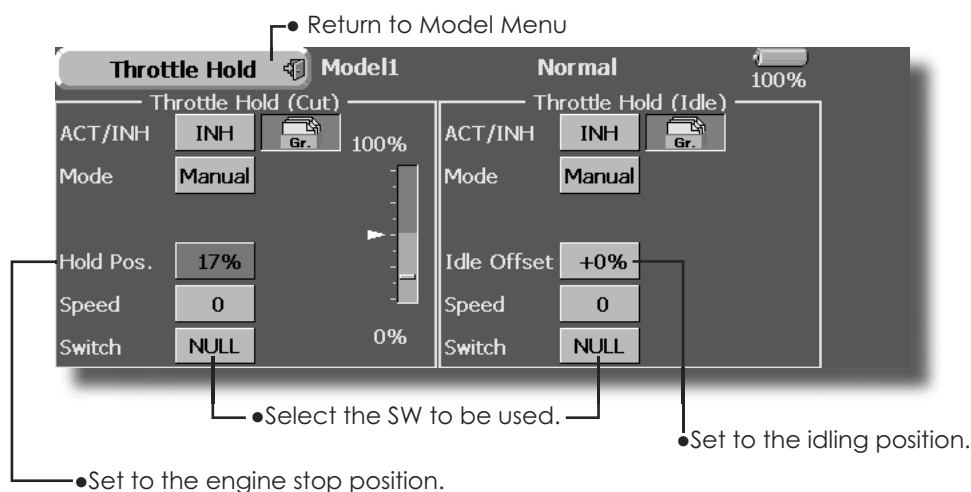

### Setting method

- Operation mode selection
  - Manual mode:** The throttle hold function is operated by switch operation only.
  - Auto mode:** The throttle hold function operation is linked to the throttle stick position.
  - Auto position setting:** When the Auto mode was selected, the throttle position (auto position) can be selected. Move the throttle stick to the position you want to set and touch the (auto position) button.
- Hold position adjustment
  - Throttle Hold (Cut)** sets the throttle cut position. Adjust it so that the carburetor is full open.
  - Throttle Hold (Idle):** Make this adjustment to maintain idling for training. Adjustments can be made based on the throttle curve idle position.
- The throttle servo operating speed can be adjusted. (Speed)
- Throttle cut or training function can be switched by hold function selector switch.

### Operation precautions

#### ⚠ WARNING

- ! When starting the engine, confirm that the idle up condition and throttle hold condition are [OFF].

## Swash mixing

The swash mix function is used to correct the swash plate in the aileron (roll) direction and elevator (cyclic pitch) corresponding to each operation of each condition.

Adjustment by independent curve for aileron, elevator, and pitch operations is possible. The operation can be smoothly adjusted by calling up the "Curve setup" screen by touching the button that corresponds to the mixing and direction which needs correction.

### Example of use

- As an example, use swash mixing to correct undesirable tendencies in the roll direction
- For a condition which uses AIL to ELE, set this function to ON. When raising the nose at a right roll, when the Rate B side is input and the right aileron is operated, the elevator moves to the down side. Tune by adjusting the Rate. For right roll, adjust to the Rate A side.

- Touch the [Swash Mix] button in the Model Menu to call the setup screen shown below.

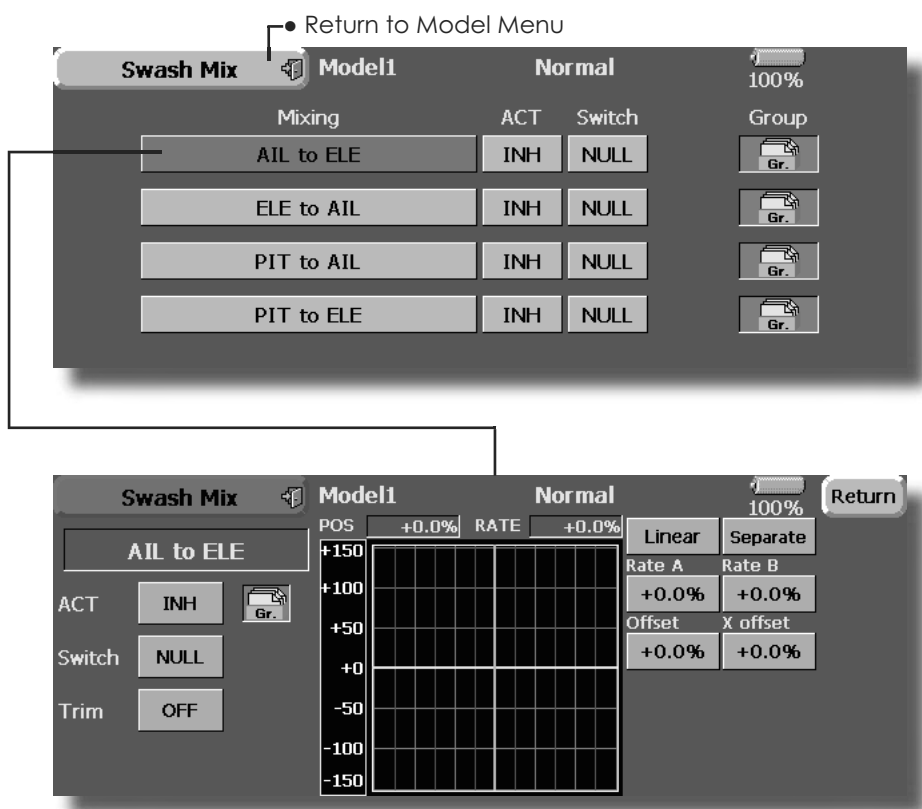

### Setting method

- When using this function, touch the [INH] button and display [ON] or [OFF].
- When you want to set the same contents at other conditions, select the group mode (Gr.). When you want to set the selected condition only, select the single mode (Sngl).
- The correction rate can be set by curve.
- A switch can be set.  
When [ NULL ] is set, the swash mixing function is operated by merely selecting the condition.

When setting an [ON]/[OFF] switch, touch the [NULL] button and set the switch and its ON position at the <Switch> screen.

- Trim on /off setting  
You can select mixing characteristics either with trim or without trim.

## Throttle mixing

This function corrects slowing of engine speed caused by swash plate operation during aileron or elevator operation. Correction of clockwise or counterclockwise torque when pirouetting can also be corrected.

An acceleration function which temporarily increases the throttle side correction rate relative to rapid stick operation can also be set.

When correction is necessary, touch the mixing corresponding to the mixing that needs correction to call the curve setup screen, and then correct the slowing.

- Touch the [Throttle Mix] button in the Model Menu to call the setup screen shown below.

- CTRM mode: The mixing rate is reduced by the throttle stick high and low position.
- LINEAR mode: Constant mixing rate to all the throttle stick ranges.

### Setting example

- AIL to THR applies a load to the engine and corrects sinking of the engine speed when the throttle stick was operated. Engine racing can be adjusted independently at the right aileron and left aileron by Rates A and B.

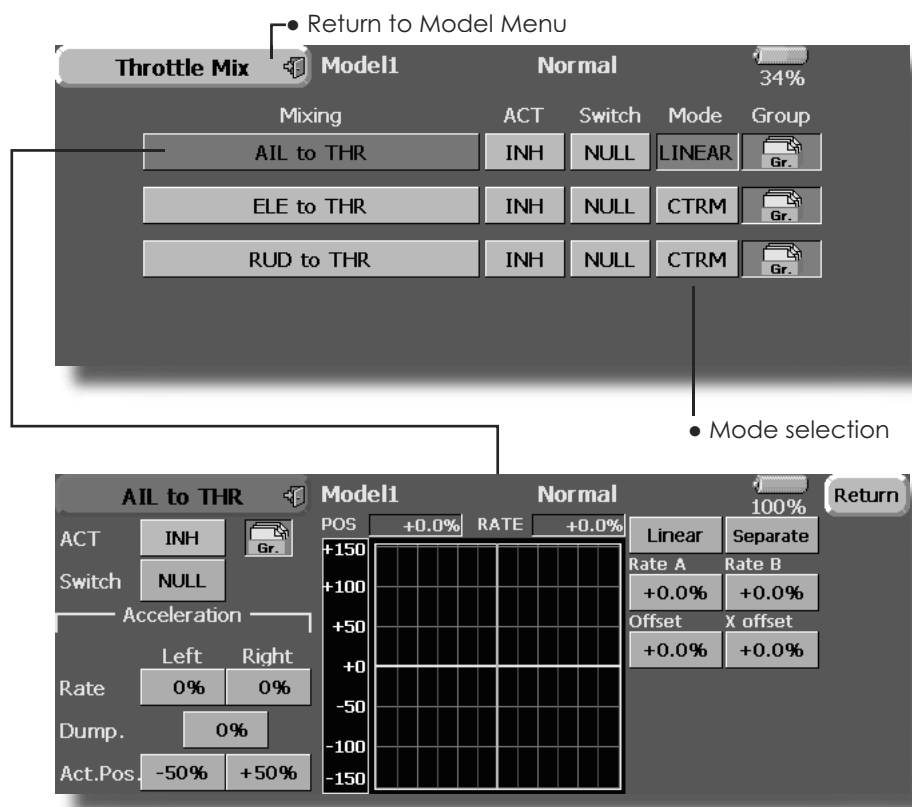

### Setting method

- When using this function, touch the [INH] button and display [ON] or [OFF].
- When you want to set the same contents at other conditions, select the group model (Gr.). When you want to set the selected condition only, select the single mode (Sngl).
- The correction rate can be set by curve.
- A switch can be set.  
When [NULL] is set, the function is operated by merely selecting the condition.  
When setting an [ON]/[OFF] switch, touch the [NULL] button and then set the switch and its ON direction at the <Switch> screen.

### <Acceleration function setting>

- Acceleration can be set for both settings (High) and (Low) at maximum correction rate.
- Acceleration rate setting (Rate)
- The return time (Dump.) after operation can be set.
- The operation point when the correction rate is increased and decreased can be set independently. When an operation point is exceeded, acceleration operation is performed.

## PIT to Needle mixing

This mixing is used when the engine is equipped with needle control or other fuel-air mixture adjustment. A needle curve can be set.

An acceleration function which temporarily increases needle operation at throttle stick acceleration/deceleration operation can be set. The rise characteristic of the needle servo at acceleration and deceleration operation can be adjusted.

- Touch the [PIT to Needle] button in the Model Menu to call the setup screen shown below.

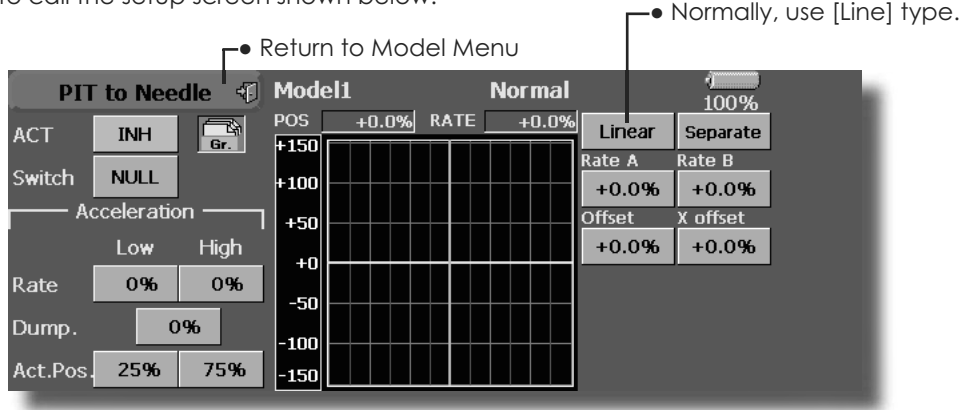

### Setting method

- When using this function, touch the [INH] button and display [ON] or [OFF].
- When you want to set the same contents at other conditions, select the group mode (Gr.). When you want to set the selected condition only, select the single mode (Sngl).
- A needle curve can be set.
- A switch can be set.  
When [NULL] is set, the function is operated by merely selecting the condition.  
When setting and [ON]/[OFF] switch, touch the [NULL] button and set the switch and its ON direction at the <Switch> screen.

### < Acceleration function setting >

- Acceleration can be set at both setting at acceleration (High) and setting at deceleration (Low).
- The acceleration rate (Rate) and the return time after operation (Dump.) can be set.
- An operation point (Operation Point) at acceleration and deceleration can be set. When an operation point was exceeded, acceleration operation is performed.

## PIT to RUD mixing (Revolution mixing)

Use this mixing when you want to suppress the torque generated by main rotor pitch and speed changes at pitch operation. Adjust so that the nose does not move in the rudder direction.

An acceleration function which temporarily increases the correction rate at throttle stick acceleration/deceleration operation can be set. The mixing rate at acceleration/deceleration can be set.

However, when a GY Series or other heading hold gyro is used, since correction is performed by the gyro, this mixing is not used. If this function is used when the gyro operation mode is the AVCS mode, the neutral position will change.

- Touch the [PIT to RUD] button in the Model Menu to call the setup screen shown below.

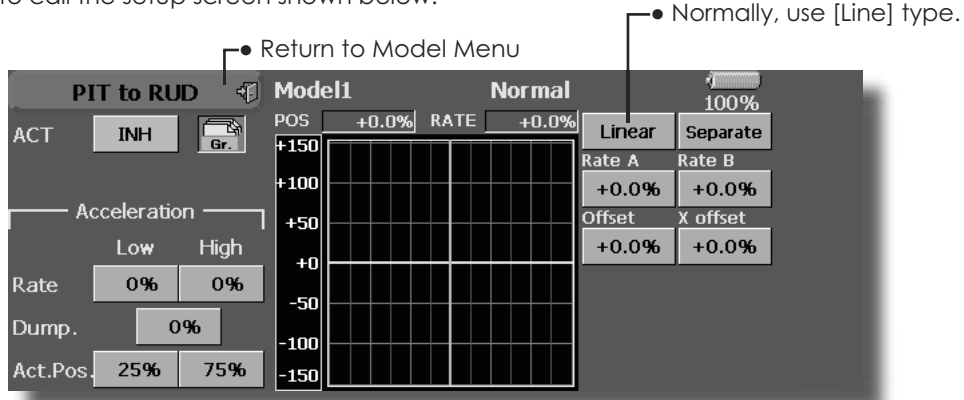

### Setting method

- When using this function, touch the [INH] button and display [ON] or [OFF].
- When you want to set the same contents at other conditions, select the group mode (Gr.). When you want to set the selected condition only, select the single mode (Sngl).
- A mixing curve is set.

#### <Normal condition mixing curve>

The mixing curve rate starts from a small value.

For a rotor with a clockwise operation direction (polarity), when pitch was operated at the plus side, set so that mixing is in the clockwise direction. First, trim at hovering and then adjust the neutral position.

1. Adjustment between slow and hovering  
Repeatedly hover from take off and land from hovering at a constant rate matched to your own rhythm, and adjust the pitch so the nose does not deflect when the throttle is raised and lowered.
2. Throttle high side (climbing from hovering and diving hovering)  
\*Repeat climbing and diving from hovering at a constant rate matched to your own rhythm and adjust the pitch so that the nose does not deflect when the throttle is raised and lowered.

#### <Idle up condition mixing curve>

Set the mixing rate so that the rudder direction at high-speed flight is straight ahead. Adjust for each condition used.

#### <Acceleration function setting>

- Acceleration operation can be performed for both setting at acceleration (High) and setting at deceleration (Low).
- Acceleration rate setting (Rate)
- The return time after operation (Dump.) can be set.
- An operation point for acceleration and deceleration can be set independently. When an operation point is exceeded, acceleration operation is performed.

## Gyro mixing

This function is used to adjust gyro sensitivity. The sensitivity and operation mode (Normal mode/GY mode) can be set for each condition.

\*Sensitivity setting is assigned to CH3.

Note: Always set both (ACT) and (Trim) for the [Gyro] function.

### Setting example

- Normally, it is convenient to preset high sensitivity (Rate 1) and low sensitivity (Rate 2) when either the AVCS mode or Normal mode is used.

- Touch the [Gyro] button in the Model Menu to call the setup screen shown below.

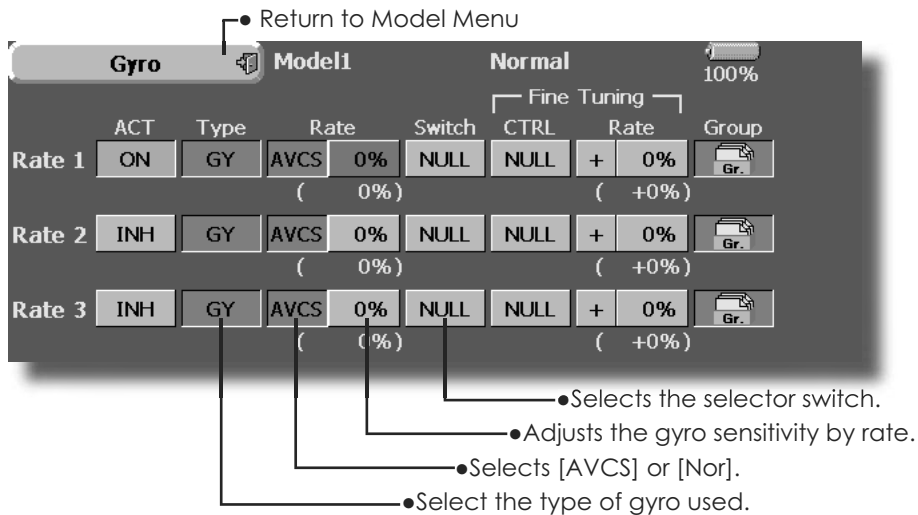

### Setting method

- Touch the [INH] button of the rate to be used and display [ON].
- When you want to set the same contents at other conditions, select the group mode (Gr.). When you want to set the selected condition only, select the single mode (Sngl).
- Three rates can be switched for each condition. (Rate 1/Rate 2/Rate 3)
- A fine tuning VR can be set.



## Governor mixing

This is used to switch the RPM of the helicopters head. Up to 3 rates can be set for each condition.

\*The governor is used by connecting the governor speed setting channel to CH7 (initial setting).

\*When using an independent governor [ON]/[OFF] switch, connect the AUX([ON]/[OFF]) connector of the governor to CH8 (initial setting) and set the switch to CH2 (Governor2) at the Function menu of the Linkage Menu.

\*When using the Fuel Mixture function, the mixture servo is controlled from the governor. When transmitting the mixture curve data from the transmitter to the governor, the governor AUX (m.trm) connector must be connected to CH8 (initial setting) and governor side setting performed. See the governor instruction manual.

Note: Always set (Act) and (Trim) to [NULL] for [Governor] and [Governor 2] of the Function menu.

- Touch the [Governor] button of the Model Menu to call the setup screen shown below.

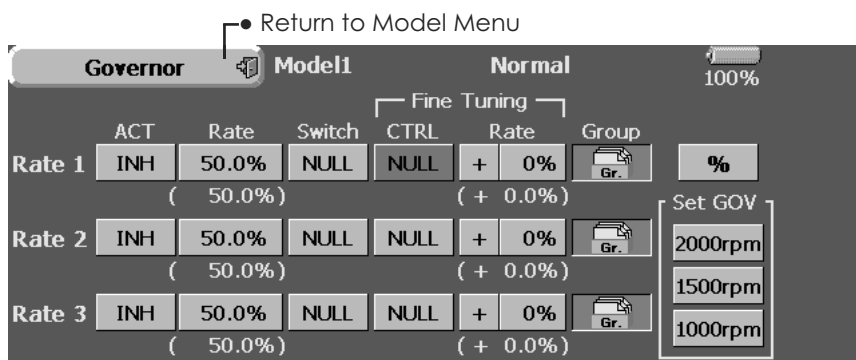

### Setting method

- Touch the [INH] button of the rate to be used and display [ON].
- When you want to set the same contents at other functions, select the group mode (Gr.). When you want to set the selected condition only, select the single mode (Sngl).
- Three speeds (rates) can be set for each condition. (Rate 1/Rate 2/Rate 3)

Also, this mixing and the governor side speed setting must be matched beforehand by the following method:

- Set so that when the governor side is placed in the speed setting item state and [2000rpm] of Set GOV of the screen above is touched, the governor speed is set to "2000", when the [1500rpm] button is touched, the governor speed is set to "1500", and when the [1000rpm] button is touched, the governor speed is set to "1000".

- When you want to read the speed directly, press the [%] button and display [rpm].
  - The speed can be wited by setting a switch. Also, when [OFF] is set instead of speed setting, the governor can be turned [ON]/[OFF] without setting a separate [ON]/[OFF] switch.
  - A speed fine tuning VR can be set.
- \*VR selection, adjustment width, and adjustment direction can be set.

## Common operations used in function setup screen

This section describes the functions often used at the function setup screen. Refer to it when setting each function.

### Operations related to flight conditions

#### Group/single mode switching (Gr./Sngl)



When setting multiple flight conditions, linking the setting contents with other conditions (Gr.) or setting independently (Sngl) can be selected. When the button is touched, it toggles between Gr. and Sngl.

\*Group mode (Gr.) (initial setting): The same setting contents are set to all the flight conditions in the group mode.

\*Single mode (Sngl): Select this mode when the setting contents are not linked with other conditions.

\*Selecting the single (Sngl) mode at each condition after presetting in the group mode (Gr.) is convenient.

#### Condition delay setting

Unnecessary fuselage motion generated when there are sudden changes in the servo position and variations in the operating time between channels at condition switching can be suppressed.

When the delay function is set at the switching destination condition, a delay corresponding to that amount is applied and the related functions change smoothly.

[Setting method]

1. Switch to the condition you want to set.
2. Touch the Delay button.
3. Use the adjustment buttons to set the delay.

\*Initial value: 0

\*Adjustment range: 0~25 (maximum delay)

### Operations related to VR tuning

#### Fine tuning VR setting

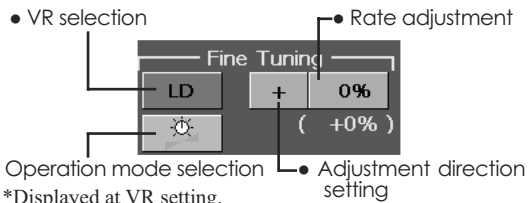

[Operation modes]



Mixing rate 0% at center of VR  
When the VR is turned counterclockwise and clockwise, the mixing rate increases and decreases, respectively.



Mixing rate 0% at left end of VR  
When the VR is turned, the mixing rate increases.



Mixing rate 0% at right end of VR.  
When the VR is turned, the mixing rate increases.



When the VR is turned to the left or right of the neutral position, the mixing rate increases.

## Operations related to servo speed

### Servo speed setting (1)



The speed at each operation (including flight condition switching) can be adjusted. The servos operate smoothly at a constant speed corresponding to the set speed. The operation speed (In Speed) and the return speed (Out Speed) can be set individually.

Switch the operation mode according to the set function. When the button is touched, it toggles between [LIN] and [SYM].

**"SYM" mode:** Mode used with ailerons and other self-neutral functions

**"LIN" mode:** Mode used with functions which hold the operation position of the throttle and switch channel, etc.

[Setting method]

1. Select the function ([LIN] or [SYM]) matched to the master channel. Each time the button is touched, it toggles between [LIN] and [SYM].
2. Touch the In or Out Speed button and set the servo speed.

Initial value: 0

Setting range: 0~27



### Servo speed setting (2)

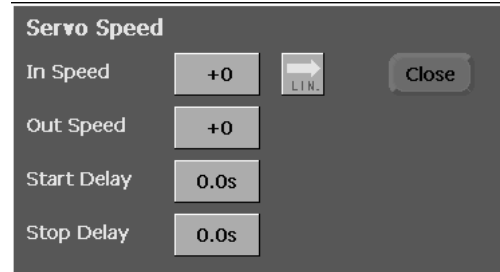

[Setting method]

1. When setting the servo speed, touch the Speed button. The Servo Speed setup screen shown above is displayed.
2. Select the function ([LIN] or [SYM]) matched to the master channel. Each time the button is touched, it toggles between [LIN] and [SYM].

"SYM" mode: Mode used with ailerons and other self-neutral functions.

"LIN" mode: Mode used with functions which hold the operating position of the throttle and switch channel, etc.

3. Touch the In Speed button and set the servo speed.  
Initial value: 0  
Setting range: 0~27
4. Touch the Out Speed button and set the servo speed.  
Initial setting: 0  
Setting range: 0~27
5. Touch the Start Delay button and set the delay time from switch ON to the start of function operation.  
Initial setting: 0.0 sec  
Setting range: 0~4 secs
6. Touch the Stop Delay button and set the delay time from switch OFF to the start of function operation.  
Initial setting: 0  
Setting range: 0~4 secs

## Curve setting operation

This section describes the setting procedure of curves which are used with the AFR function and each mixing function.

### Curve type selection

When the curve type select button on the mixing function screen or other screen is touched, the setup screen shown below is called.

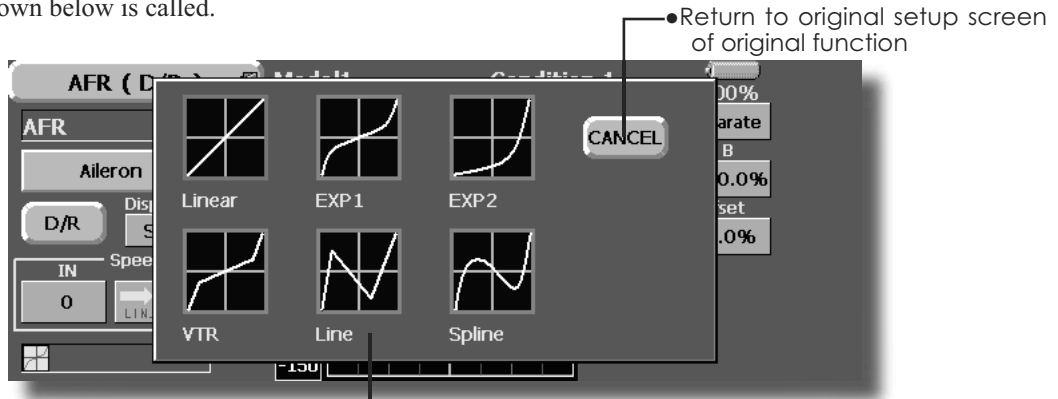

#### Curve type selection

1. Touch the button of the curve type you want to use.
- \*The curve type changes and the display returns to the original screen.

### Setting by curve type

When the curve type is selected as described above, adjustment buttons corresponding to the curve type appear on the original screen. Adjust each curve as described below.

#### Linear curve adjustment

Rate A and Rate B can be adjusted separately or simultaneously.

[Setting modes]

\***[Separate] mode:** Rates are adjusted separately.

\***[Combined] mode:** Rates are adjusted simultaneously.

[Setting method]

1. Select the setting mode.
2. Touch the Rate A or Rate B button.
3. Use the adjustment buttons to set the rate.

\*Initial value: +100.0%

\*Adjustment range: -200.0~+200.0%

The curve can also be offset horizontally in the vertical direction and the rate reference point can be offset to the left or right.

[Offsetting the curve horizontally in the vertical direction]

1. Touch the Offset button.
2. Use the adjustment buttons to move the curve horizontally up and down.

\*Initial value: +0.0%

[Offsetting the rate reference point to the left or right]

1. Touch the X Offset button.
2. Use the adjustment buttons to move the reference point to the left or right.

\*Initial value: +0.0%

(Linear curve)

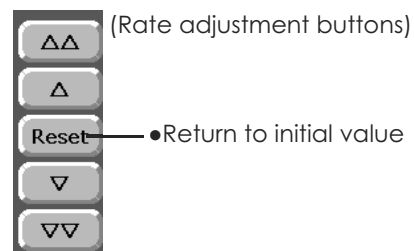
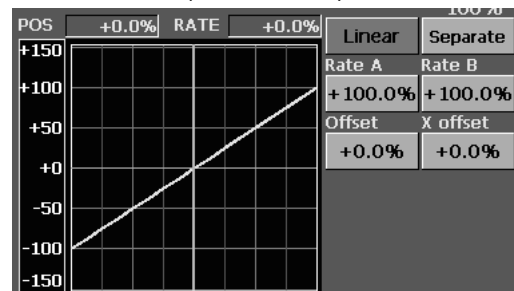

### EXP1 curve adjustment

Rate A and Rate B can be adjusted separately or simultaneously. The EXP curves rate (EXP A, EXP B) can also be adjusted separately or simultaneously.

[Setting modes]

\***[Separate] mode:** Rates are adjusted separately.

\***[Combined] mode:** Rates are adjusted simultaneously.

[Setting method]

1. Select the setting mode.
2. Touch the button of the rate or EXP curve rate you want to set.
3. Use the adjustment buttons to set the rate.

\*Initial value: +100.0% (rate), +0.0 (EXP rate)

The curve can also be horizontally offset in the vertical direction.

[Offsetting the curve horizontally in the vertical direction]

1. Touch the Offset button.
2. Use the adjustment buttons to move the curve horizontally up or down.

\*Initial value: +0.0

### VTR curve adjustment

Rate A and Rate B can be adjusted separately or simultaneously. The VTR curve point positions (P. Pos. A, P. Pos. B) and rates (P. Rate A, P. Rate B) can also be adjusted separately or simultaneously.

[Setting modes]

\***[Separate] mode:** Positions and rates are adjusted separately.

\***[Combined] mode:** Positions and rates are adjusted simultaneously.

[Setting method]

1. Select the setting mode.
2. Touch the button of the rate or VTR curve point position (or rate) you want to set.
3. Use the adjustment buttons to set the VTR curve point position (or rate).

\*Initial values: +100.0% (Rate), -50.0% (P.Pos.A), +50.0% (P.Pos.B), +0.0% (P. Rate)

The curve can also be offset horizontally in the vertical direction.

[Offsetting the curve horizontally in the vertical direction]

1. Touch the Offset button.
2. Use the adjustment buttons to move the curve horizontally up and down with the adjustment buttons.

\*Initial value: +0.0%

(EXP1 curve)

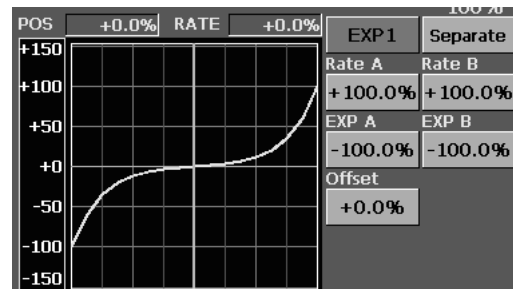

- Using the EXP1 curve is helpful in smoothening starting of the ailerons, elevators, rudder, etc.

(EXP2 curve)



- Using the EXP2 curve is helpful in engine rise and other engine control.

(VTR curve)



- Setting is fast if left, right, up, and down are first decided in the Combined mode and the mode is then switched to the Separate mode.

When this curve is used when the control surface angle is large such as with acrobatic models, switching from normal flight to acrobatic is performed without switch operation.

## Line and spline curve adjustment

Line curves or spline curves of up to 17 points can be used. (Initial value: 9 points) The set points can be freely increased, decreased, and offset. Curves which are symmetrical to the left and right of center can also be set.

[Setting modes]

\***[Separate] mode:** Normal setting

\***[Combined] mode:** Creates a left and right symmetrical curve.

[Adjusting the rate of each point]

1. Use the move between points buttons [ << ] or [ >> ] to select the point. (The pink point is the selected point.)
2. Touch the Rate button.
3. Use the adjustment buttons to adjust the rate.

### [Point addition method]

1. After touching the point button, move the stick, etc. to the point you want to add and press the [Move] button. (An outlined point appears on the graph.)

Or move the stick, etc. to the position you want to add and press the [Move] button. (An outlined point appears on the graph.)

2. Use the move buttons [ < ] or [ > ] to fine adjust the position.

3. Touch the Rate button.

\*A new point is created.

### [Point deletion]

1. Use the move between points button [ << ] or [ >> ] and select the point. (The pink point is the selected point.)
2. Touch the [Delete] button. (The selected point becomes an outlined point.)
3. Touch the move between point button [ << ] or [ >> ].

\*The point is deleted.

The curve can also be offset horizontally in the vertical direction.

[Offsetting the curve horizontally in the vertical direction]

1. Touch the Offset button.
2. Use the adjustment buttons to move the curve horizontally up and down.

\*Initial value: +0.0%

(Line curve)

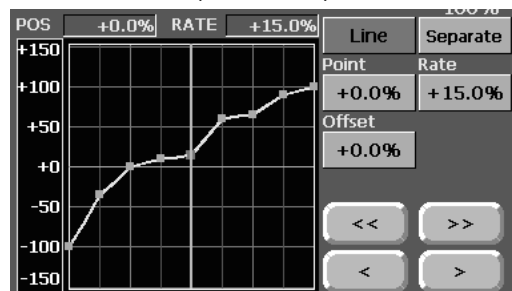

(Spline curve)

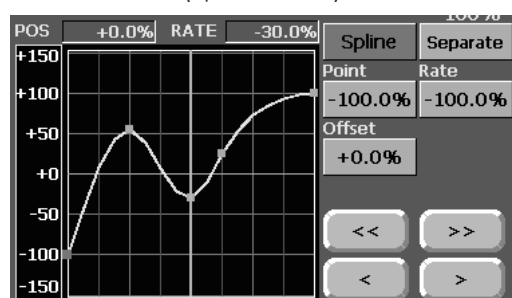

(Rate adjustment buttons)

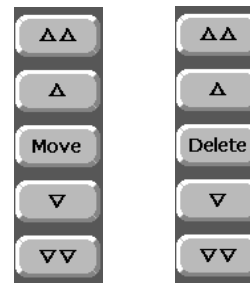

## Switch selection method

The various functions used in the FX-40 can be selected by switch. The switch (including when stick, trim lever, or VR are used as a switch) setting method is common to all functions.

### Switch selection

When the switch select button at a mixing function screen or other screen is touched, the selection shown below is called.

(Switch selection screen example)

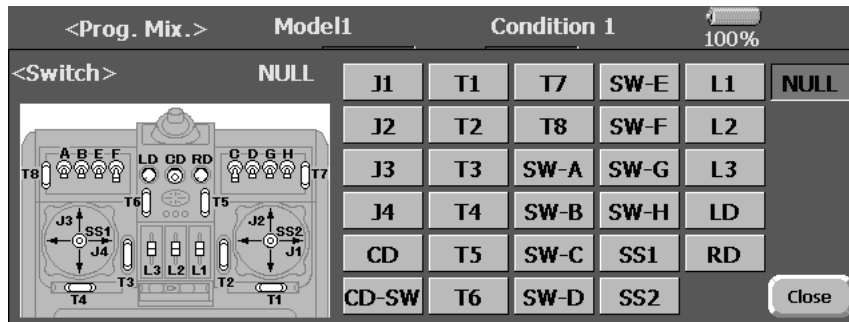

### When switch is selected

Switch ON/OFF setting is possible at each position.

- **Alternate:** Alternate switching mode is available depending on mixing function.

1. When the ON position switch is touched after the switch was selected, the screen shown below appears.

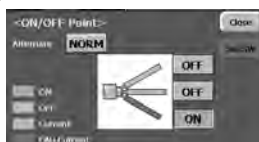

- \*When the button of each position is touched, it toggles between ON and OFF.
2. Touch the button and set to the ON position.
3. Close the screen by touching [Close].

### When stick, trim lever, or VR is selected.

When a stick, trim lever, or VR is used as a switch, the following 4 modes can be selected.

- **Mode:** Lin/Sym
- **Type:** Hysteresis (Hys.)/box (Box)

1. When the ON position button is touched after stick, etc. was selected, the screen shown below appears.



2. Select the mode you want to use, and set it as described below.
3. Close the screen by touching [Close].

## Operation modes

The operation modes when stick, trim lever or VR are selected are described below. Change the operation mode by touching the Mode and Type buttons.

### Linear hysteresis mode

This setting method selects function ON/OFF based on the set point. Hysteresis (dead band) can be set between ON and OFF. The ON and OFF positions can be reversed with the Reverse button.



### Symmetrical hysteresis mode

Operation is the same as the linear hysteresis mode, but left and right (up and down) operations are symmetrical about the neutral position. For example, when you want to switch DR1 with the aileron stick, when the stick is moved to the left or right, DR1 can be turned ON at the same left and right position.



### Linear box mode

This mode turns on the switch within a range of 2 points. Each point can be set. The ON and OFF positions can be reversed with the Reverse switch.



### Symmetrical box mode

Operation is the same as the linear box mode, but left and right (up and down) operation is symmetrical about the neutral position.



### When shifting the ON/OFF point

The ON/OFF and hysteresis (dead band) boundary point (there are 2 points: top and bottom) position can be shifted. ON/OFF is possible at a free position.

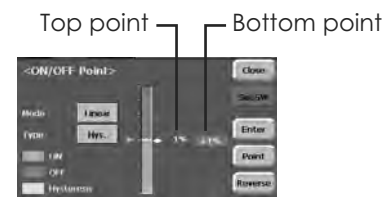

[Setting method]

1. Select the top and bottom boundary points with the [Point] button.
2. Move the stick, etc. to the point you want to shift and touch the [Enter] button. The boundary points change.

\*Also shift other points, as required.



## Updating

FX-40 transmitter program can be updated. When functions are added or improved, the update file can be downloaded from our website. Copy the update files to the CF card and then use the following procedure to update the program.

### Updating procedure

Note: If the battery fully discharges during program updating, updating will fail. When the remaining battery capacity is 50% or less, always recharge the battery before updating.

Note: The model data in the transmitter will not be changed after updating, but to be safe, back up the model data before updating.

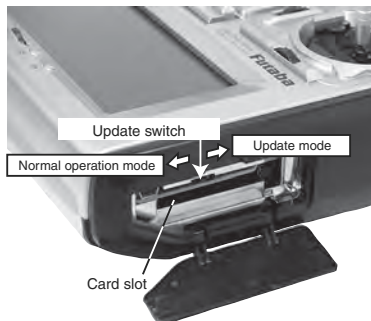

1. Insert the CF card containing the update file into the card slot.
2. Use tweezers to switch the slide switch (update switch) at the side of the card slot in the up direction.
3. Turn on the transmitter power. About 10 seconds later, the screen shown below will appear. To abort updating, turn off the transmitter power.

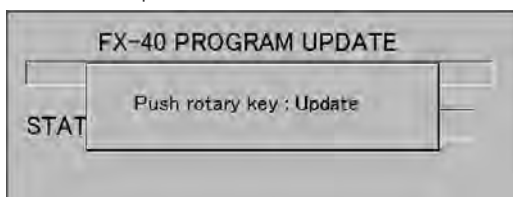

Note: If a CF card is not inserted into the card slot, or the files needed are not copied to the CF card, the error message shown below will appear. Turn off the power to the transmitter and check the CF card.

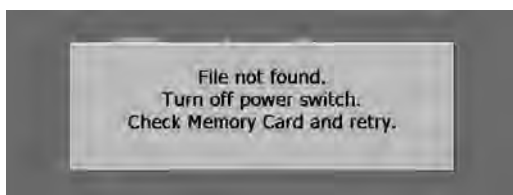

4. When the rotary switch is pushed, updating starts. During updating, the bar graph moves to the right.

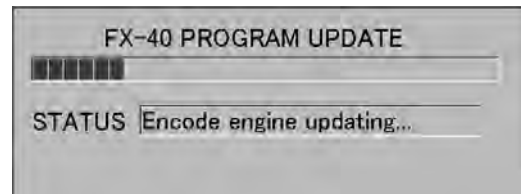

5. When updating is complete, the screen shown below appears.

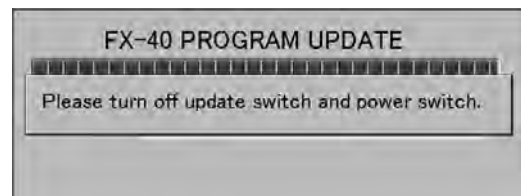

6. Turn off the power switch. After the monitor LED goes off, switch the update switch in the down direction.

After the updating above has been completed, turn on the power and then check the system program version at the system menu information screen.