



Sopwith Camel 60 ARF

ASSEMBLY MANUAL



Specifications

Wingspan.....	61 in (1551mm)	Length.....	41.3 in (1050mm)
Wing Area	1236 sq in (79.7 sq dm)	Weight.....	7.25–8.75 lb (3.3kg–4.0kg)

Table of Contents

Contents of Kit	3
UltraCote® Covering Colors	4
Radio and Power Systems Requirements	4
Field Equipment Required	4
Optional Field Equipment	4
Required Tools and Adhesives	5
Limited Warranty Period	6
Limited Warranty & Limits of Liability	6
Safety Precautions	6
Questions, Assistance, and Repairs	6
Questions or Assistance	6
Inspection or Repairs	7
Warranty Inspection and Repairs	7
Non-Warranty Repairs	7
Safety, Precautions, and Warnings	8
Before Starting Assembly	8
Using the Manual	8
Section 1: Cabane Strut Installation	9
Section 2: Landing Gear Installation	10
Section 3A: Engine Installation	13
Section 3B: Electric Motor Installation	17
Section 4: Cowling Installation	19
Section 5: Aileron Servo Installation	21
Section 6: Bottom Wing Installation	25
Section 7: Top Wing Installation	27
Section 8: Tail Installation	31
Section 9: Radio Installation	36
Section 10: Rigging Installation	42
Section 11: Center of Gravity (CG)	46
Control Throws	47
Adjusting the Engine	48
Pre-Flight	48
Range Test Your Radio	48
Notes	49
2006 Official AMA National Model Aircraft Safety Code	50

Contents of Kit

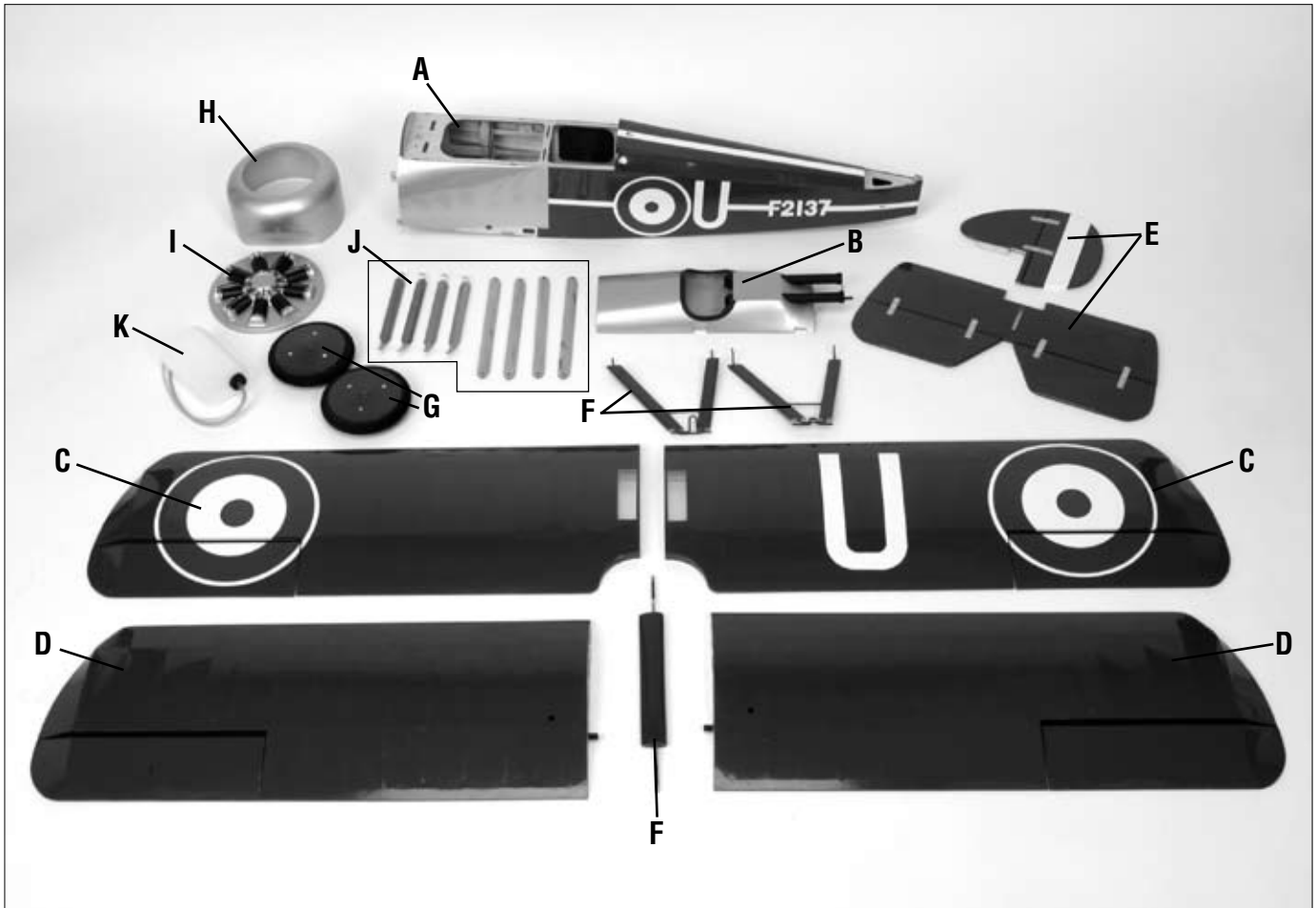

Replacement Parts

A.	Fuselage	HAN4226
B.	Fuselage Hatch	HAN4227
C.	Top Wing Set	HAN4228
D.	Bottom Wing Set	HAN4229
E.	Tail Set	HAN4230
F.	Landing Gear	HAN4231
G.	Wheel Set	HAN4232
H.	Fiberglass Cowl	HAN4233
I.	Dummy Engine	HAN4234
J.	Strut Set	HAN4235
K.	Fuel Tank	HAN4241

Items not shown

Tail Skid	HAN4236
Pushrod Set	HAN4237
Flying Wire Set	HAN4238
Aluminum Wing Tube	HAN4239
EP Motor Mount	HAN4245
Glow Motor Mount	HAN40M
O-Rings (10) (for landing gear)	HAN4240

UltraCote® Covering Colors

- | | | | |
|--------------|---------|-------------|---------|
| • Olive Drab | HANU904 | • White | HANU870 |
| • True Red | HANU866 | • Deep Blue | HANU873 |
| • Grey | HANU882 | • Silver | HANU881 |

Radio and Power Systems Requirements

- 4-Channel radio system (minimum) w/receiver
- 537 Standard Servo (JRPS537) (5) or equivalent (4 required when building the electric version)
- 9" Servo Lead Extension (JRPA097) (2)
- 6" Y-Harness (JSP98020)

Recommended JR Systems

- XP9303
- XP6102
- XP662
- XF631
- XF421EX



JR XP9303



JR XP6102



Evolution .61NT
EVOE0610



Saito .82 AAC
SAIE082A



Power 46 Brushless
Outrunner Motor, 670KV
EFLM4046A

Recommended Power Systems

- .61 2-stroke
- .72-.82 4-stroke
- Power 46 Brushless Outrunner

Field Equipment Required

- | | |
|---|---|
| • Propeller | • Fuel |
| • Long Reach Glow Plug Wrench (HAN2510) | • Metered Glow Driver w/Ni-Cd & Charger (HAN7101) |
| • 2-Cycle Sport Plug (HAN3001) | • 2-Cycle Super Plug (HAN3006) |
| • 4-Cycle Super Plug (HAN3011) | • Manual Fuel Pump (HAN118) |

Optional Field Equipment

- | | |
|-----------------------------------|----------------------------------|
| • 12V 7Ah Sealed Battery (HAN102) | • PowerPro™ 12V Starter (HAN161) |
|-----------------------------------|----------------------------------|

Required Tools and Adhesives

Tools

- Drill
- Adjustable wrench
- Hobby knife
- Phillips screwdriver
- Side cutters
- 4-40 tap
- Crimping tool
- Drill bits: 1/16" (1.5mm), 5/64" (2mm), 3/32" (2.5mm)
1/8" (3mm), \$43, 5/32" (4mm)
- T-pins
- Hex wrench: 7/64", 3/32"
- Hobby scissors
- Pliers
- Nut driver: 5.5mm
- Tap handle

Adhesives

- 6-minute epoxy (HAN8000)
- Thin CA
- Zap-A-Dap-A-Goo
- Medium CA
- 30-minute epoxy (HAN8002)
- Canopy glue
- Threadlock

Other Required Items

- Epoxy brushes
- Measuring device (e.g. ruler, tape measure)
- Paper towels
- Masking tape
- Sandpaper
- Sealing Iron (HAN101)
- Sealing Iron Sock (HAN141)
- Solder
- Deans connector (female)
- Felt-tipped pen or pencil
- Mixing sticks for epoxy
- Rubbing alcohol
- Sanding bar
- Rotary tool w/sanding drum
- Covering Glove (HAN150)
- Soldering iron
- Deans connector (male) (3)
- Cardstock

Limited Warranty Period

Horizon Hobby, Inc. guarantees this product to be free from defects in both material and workmanship at the date of purchase.

Limited Warranty & Limits of Liability

Pursuant to this Limited Warranty, Horizon Hobby, Inc. will, at its option, (i) repair or (ii) replace, any product determined by Horizon Hobby, Inc. to be defective. In the event of a defect, these are your exclusive remedies.

This warranty does not cover cosmetic damage or damage due to acts of God, accident, misuse, abuse, negligence, commercial use, or modification of or to any part of the product. This warranty does not cover damage due to improper installation, operation, maintenance, or attempted repair by anyone other than an authorized Horizon Hobby, Inc. service center. This warranty is limited to the original purchaser and is not transferable. In no case shall Horizon Hobby's liability exceed the original cost of the purchased product and will not cover consequential, incidental or collateral damage. Horizon Hobby, Inc. reserves the right to inspect any and all equipment involved in a warranty claim. Repair or replacement decisions are at the sole discretion of Horizon Hobby, Inc. Further, Horizon Hobby reserves the right to change or modify this warranty without notice.

REPAIR OR REPLACEMENT AS PROVIDED UNDER THIS WARRANTY IS THE EXCLUSIVE REMEDY OF THE CONSUMER. HORIZON HOBBY, INC. SHALL NOT BE LIABLE FOR ANY INCIDENTAL OR CONSEQUENTIAL DAMAGES.

As Horizon Hobby, Inc. has no control over use, setup, final assembly, modification or misuse, no liability shall be assumed nor accepted for any resulting damage or injury. By the act of use, setup or assembly, the user accepts all resulting liability.

If you as the purchaser or user are not prepared to accept the liability associated with the use of this product, you are advised to return this product immediately in new and unused condition to the place of purchase.

Safety Precautions

This is a sophisticated hobby product and not a toy. It must be operated with caution and common sense and requires some basic mechanical ability. Failure to operate this product in a safe and responsible manner could result in injury or damage to the product or other property. This product is not intended for use by children without direct adult supervision. The product manual contains instructions for safety, operation and maintenance. It is essential to read and follow all the instructions and warnings in the manual, prior to assembly, setup or use, in order to operate correctly and avoid damage or injury.

Questions, Assistance, and Repairs

Your local hobby store and/or place of purchase cannot provide warranty support or repair. Once assembly, setup or use of the product has been started, you must contact Horizon Hobby, Inc. directly. This will enable Horizon to better answer your questions and service you in the event that you may need any assistance.

Questions or Assistance

For questions or assistance, please direct your email to productsupport@horizonhobby.com, or call 877.504.0233 toll free to speak to a service technician.

Inspection or Repairs

If your product needs to be inspected or repaired, please call for a Return Merchandise Authorization (RMA). Pack the product securely using a shipping carton. Please note that original boxes may be included, but are not designed to withstand the rigors of shipping without additional protection. Ship via a carrier that provides tracking and insurance for lost or damaged parcels, as Horizon Hobby, Inc. is not responsible for merchandise until it arrives and is accepted at our facility. Include your complete name, address, phone number where you can be reached during business days, RMA number, and a brief summary of the problem. Be sure your name, address, and RMA number are clearly written on the shipping carton.

Warranty Inspection and Repairs

To receive warranty service, you must include your original sales receipt verifying the proof-of-purchase date. Providing warranty conditions have been met, your product will be repaired or replaced free of charge. Repair or replacement decisions are at the sole discretion of Horizon Hobby.

Non-Warranty Repairs

Should your repair not be covered by warranty and the expense exceeds 50% of the retail purchase cost, you will be provided with an estimate advising you of your options. You will be billed for any return freight for non-warranty repairs. Please advise us of your preferred method of payment. Horizon Hobby accepts money orders and cashiers checks, as well as Visa, MasterCard, American Express, and Discover cards. If you choose to pay by credit card, please include your credit card number and expiration date. Any repair left unpaid or unclaimed after 90 days will be considered abandoned and will be disposed of accordingly.

Electronics and engines requiring inspection or repair should be shipped to the following address (freight prepaid):

Horizon Service Center
4105 Fieldstone Road
Champaign, Illinois 61822

All other products requiring inspection or repair should be shipped to the following address (freight prepaid):

Horizon Product Support
4105 Fieldstone Road
Champaign, Illinois 61822

Safety, Precautions, and Warnings

As the user of this product, you are solely responsible for operating it in manner that does not endanger yourself and others or result in damage to the product or the property of others.

Carefully follow the directions and warnings for this and any optional support equipment (chargers, rechargeable battery packs, etc.) that you use.

This model is controlled by a radio signal that is subject to interference from many sources outside your control. This interference can cause momentary loss of control so it is necessary to always keep a safe distance in all directions around your model, as this margin will help to avoid collisions or injury.

- Always operate your model in an open area away from cars, traffic, or people.
- Avoid operating your model in the street where injury or damage can occur.
- Never operate the model out into the street or populated areas for any reason.
- Never operate your model with low transmitter batteries.
- Carefully follow the directions and warnings for this and any optional support equipment (chargers, rechargeable battery packs, etc.) that you use.
- Keep all chemicals, small parts and anything electrical out of the reach of children.
- Moisture causes damage to electronics. Avoid water exposure to all equipment not specifically designed and protected for this purpose.

Before Starting Assembly

Before beginning the assembly of the Sopwith Camel, remove each part from its bag for inspection. Closely inspect the fuselage, wing panels, rudder, and stabilizer for damage. If you find any damaged or missing parts, contact the place of purchase.

If you find any wrinkles in the covering, use a heat gun or sealing iron to remove them. Use caution while working around areas where the colors overlap to prevent separating the colors.



HAN101 – Sealing Iron

**HAN141 – Sealing Iron
Sock**



HAN100 – Heat Gun

HAN150 – Covering Glove

Using the Manual

This manual is divided into sections to help make assembly easier to understand, and to provide breaks between each major section. In addition, check boxes have been placed next to each step to keep track of each step completed. Steps with a single box () are performed once, while steps with two boxes () indicate that the step will require repeating, such as for a right or left wing panel, two servos, etc. Remember to take your time and follow the directions.

Section 1: Cabane Strut Installation

Required Parts

- Front cabane strut (R&L)
- Rear cabane strut (R&L)
- 4-40 x 1/2" socket head screw (4)
- 4-40 x 1/4" socket head screw (4)

Required Tools and Adhesives

- Hex wrench: 3/32" • Threadlock

With so many parts in this model, we are going to start with some easy items to help reduce the amount of parts you have to keep track of. The best way to do this is to attach the cabane struts to the fuselage.

□ Step 1

Locate two of the cabane struts. Make sure you grab a pair, as they have an airfoil shape to them. Slide them into the slots in the front of the fuselage behind the firewall with the wide side of the airfoil towards the front, just like a wing. Check that the tab at the top faces away from the centerline of the fuselage.

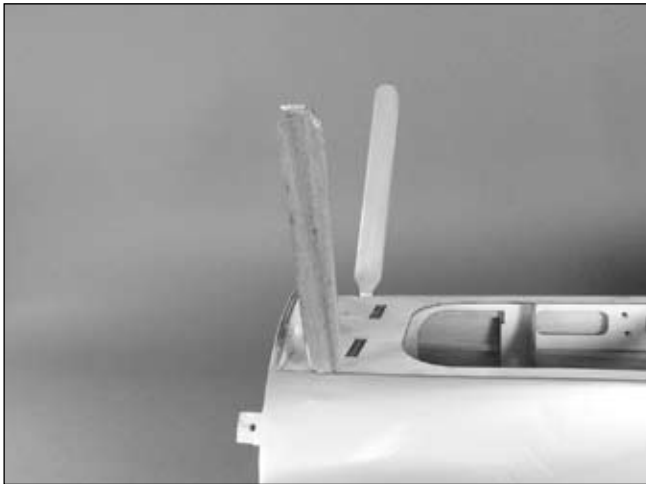

Important: Check that the front struts have been installed in the front. This can be determined by the angle of the tab. When installed correctly, the tab will be parallel to the top of the fuselage opening.

□ Step 2

Use four 4-40 x 1/2" socket head screws to secure the front struts to the fuselage. Blind nuts have been installed inside the fuselage for the screws to thread into.

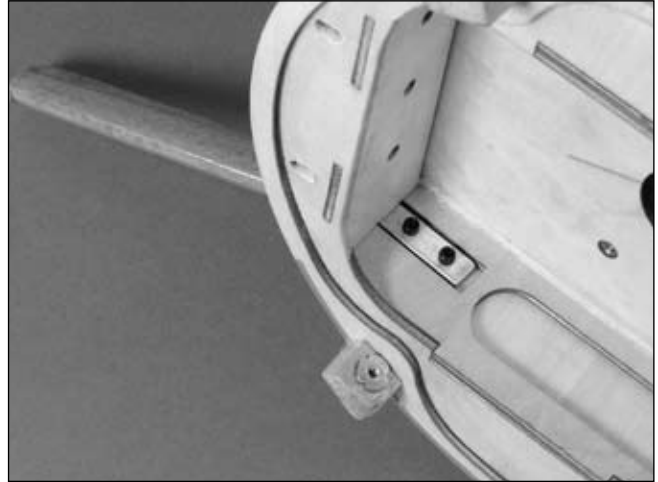

Note: Make sure to use threadlock on all four screws to prevent them from vibrating loose.

□ Step 3

Slide the two remaining struts into the slots towards the center of the fuselage opening, making sure they are positioned correctly.

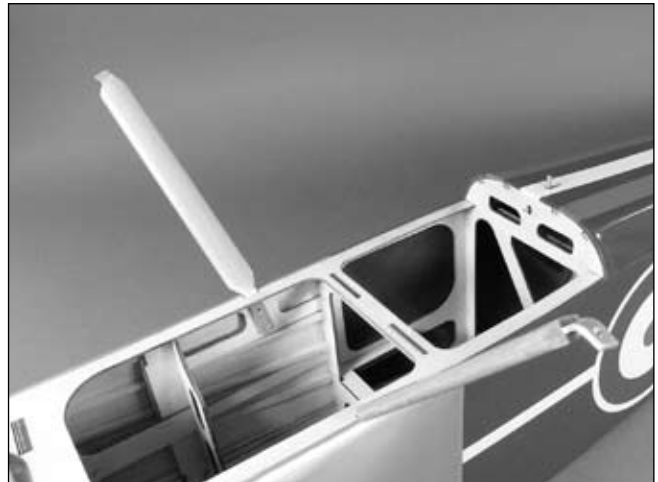

Section 1: Cabane Strut Installation

□ Step 4

Secure the struts using four 4-40 x 1/4" socket head screws. Again, use threadlock on the screws to prevent them from vibrating loose.



Hint: Check the positions of the rear tabs in comparison to the front tabs. They should be parallel to each other and to the top of the fuselage opening. If you didn't see it back in Step 1, you will certainly notice now.

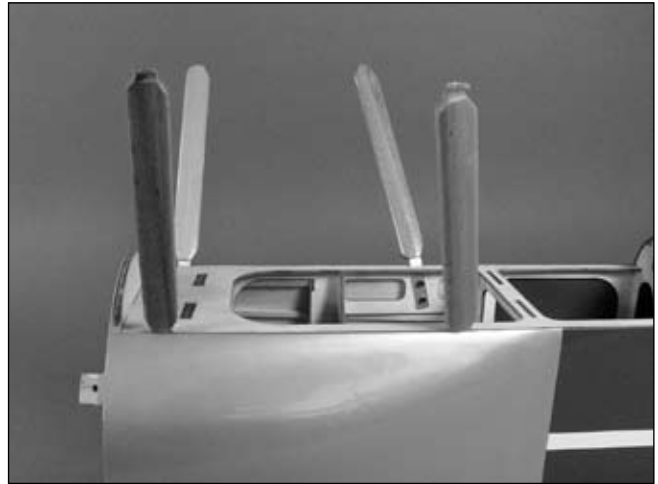

Section 2: Landing Gear Installation

Required Parts

- Landing gear (R&L)
- Steel axle guide (2)
- 4mm washer (2)
- Rubber O-ring (6)
- Landing gear cross brace
- Landing gear strap (5)
- 3mm x 12mm sheet metal screw (10)
- Tail skid
- 3mm setscrew (2)
- 4mm locknut (2)
- Scale wheel (2)

Required Tools and Adhesives

- Hex wrench (included)
- Phillips screwdriver
- 5.5mm nut driver or adjustable wrench
- Threadlock

The Sopwith features a scale landing gear that uses O-rings to act as shock absorbers. It is just a little more complicated than a regular landing gear to install. It also features a scale landing skid rather than the usual tail wheel. These are great features and details that add to the final results.

□ Step 1

Place the tail skid into the pre-drilled hole at the aft end of the fuselage.



Section 2: Landing Gear Installation

□ Step 2

Use a landing gear strap and two 3mm x 12mm sheet metal screws to secure the tail skid into position.

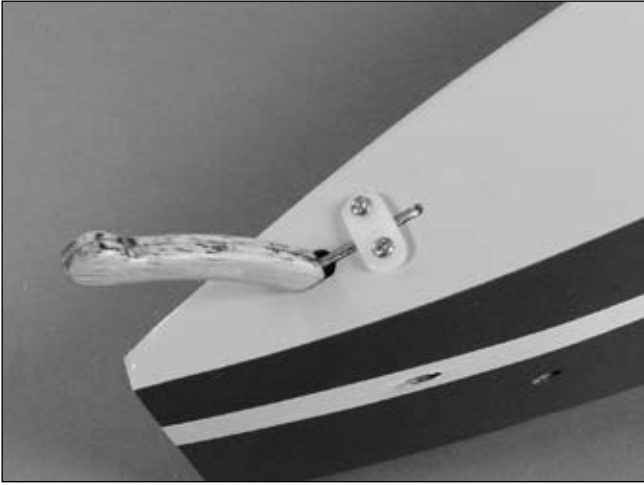

□ Step 3

Place either the right or left landing gear into position on the bottom of the fuselage. Use two landing gear straps and four 3mm x 12mm sheet metal screws to secure the gear to the fuselage.



Note: Although this is obvious, the gear angles out away from the fuselage centerline and towards the front of the fuselage.

□ Step 4

Slide the landing gear cross brace through the landing gear. Make sure both the airfoils are facing the correct direction, and that the flat spot in the axle faces toward the ground when the plane is resting upright (or away from the fuselage).

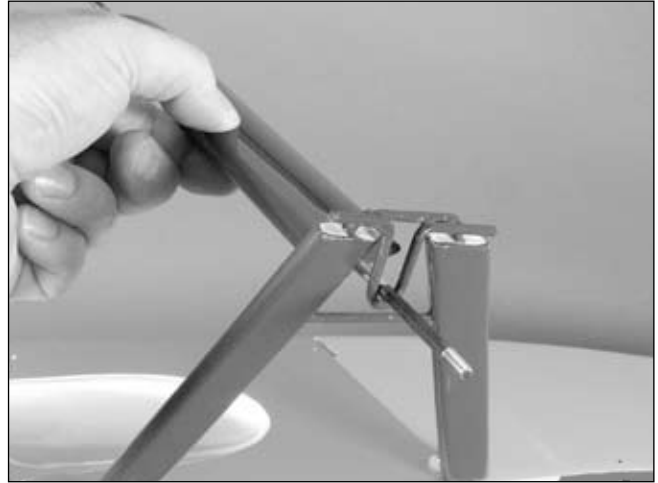

□ Step 5

Position the remaining landing gear onto the fuselage, passing the cross brace through the gear. Secure the landing gear to the fuselage with two landing gear straps and four 3mm x 12mm sheet metal screws.



Section 2: Landing Gear Installation

□ Step 6

Attach the steel axle guide to the landing gear using a 3mm setscrew and threadlock. The setscrew tightens onto the flat of the axle to keep the cross brace from rotating. Position the second steel axle guide onto the cross brace. Secure it into position using a 3mm setscrew and threadlock.



Note: It may be necessary to adjust the steel axle guides until the cross brace can move up and down with as little interference as possible.

□ Step 7

Place three rubber O-rings onto the landing gear as shown. The O-rings will keep the cross brace in the “down” position when installed. The O-rings must be very tight to stop the axle from rotating.

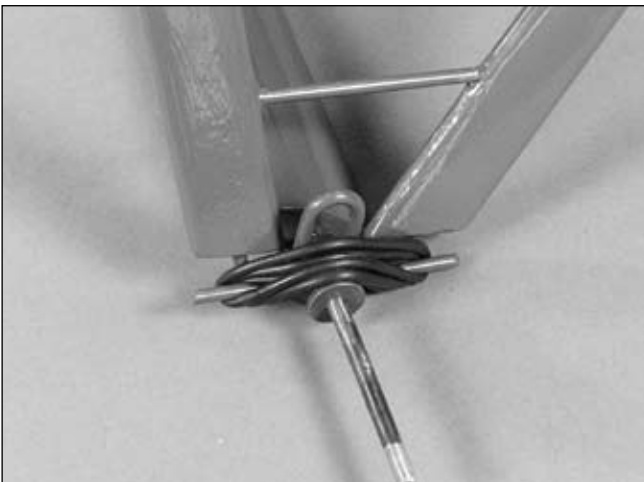

Hint: You can pre-stretch the O-rings slightly before installing them, similar to that of pre-stretching a balloon before blowing it up.

Note: Rubber bands can also be used in place of the O-rings in the case of an O-ring becoming damaged.

□ Step 8

Slide the scale wheel onto the axle. Slide a 4mm washer onto the axle, and then tighten a 4mm nut onto the axle to secure the wheel. Tighten the nut enough to limit the play of the wheel on the axle, but leave it loose enough so the wheel can rotate freely.



Section 3A: Engine Installation

Required Parts

- 8-32 washer (12)
- Fuel tank
- Engine mount (R&L)
- 8-32 x 1" machine screw (4)
- 8-32 x 1 1/4" machine screw (4)
- 16 1/2" (420mm) pushrod tube
- 14 1/4" 3(62mm) threaded pushrod wire
- Nylon clevis w/retainer
- 8-32 locknut (4)
- Tie-wrap (2)

Required Tools and Adhesives

- Drill
- Felt-tipped pen
- Phillips screwdriver
- Medium grit sandpaper
- Rubbing alcohol
- Medium CA
- Drill bit: 5/32" (4mm)
- Threadlock
- Engine
- Side cutters
- Paper towel

□ Step 1

Attach the engine mount onto the firewall using four 8-32 x 1" machine screws and four #8 washers.

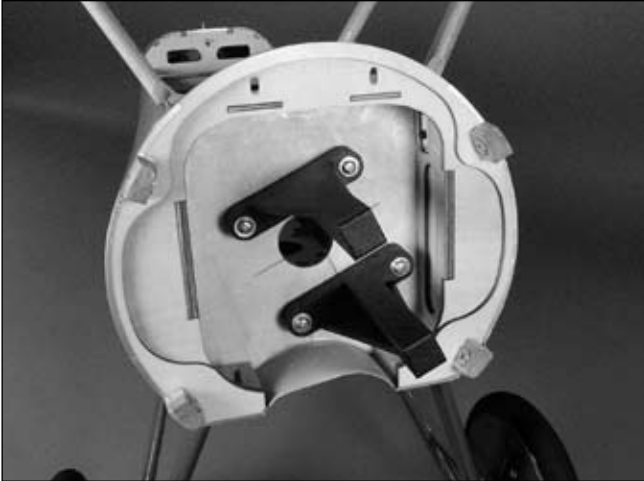

Note: Use threadlock on the screws to prevent them from vibrating loose.

□ Step 2

Position the engine onto the engine mount. Move the engine fore and aft until the front of the drive washer is 5 1/2" (140mm) from the front of the firewall. Mark the locations for the engine mounting bolts onto the engine mount using a felt-tipped pen.

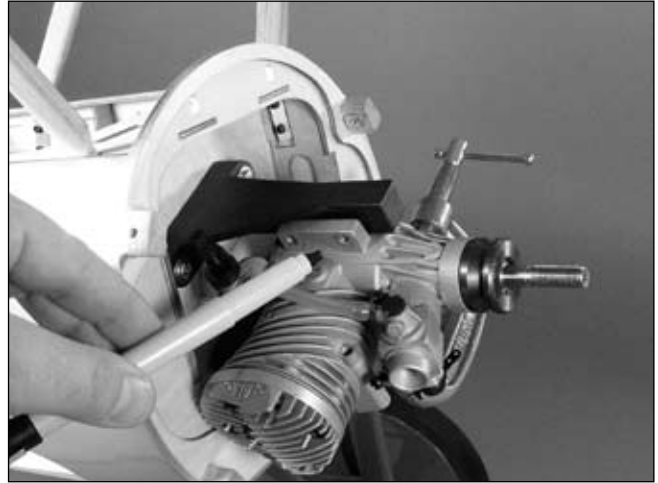

Hint: Use small clamps to hold the engine in position when marking the mount.

□ Step 3

Use a drill and 5/32" (4mm) drill bit to drill the four locations for the engine mounting bolts.



Hint: Removing the engine mounts from the fuselage and using a drill press is highly recommended as this will allow the holes to be drilled perpendicular to the mounts.

Section 3A: Engine Installation

□ Step 4

Attach the engine to the engine mount using four 8-32 x 1 1/4" machine screws, four 8-32 lock nuts and eight #8 washers.

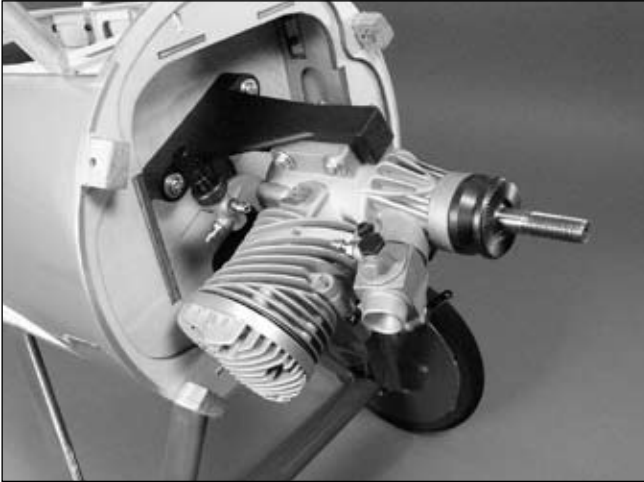

Hint: If you are having trouble getting to the screws, remove the mount from the firewall and install the screws holding the engine. Reattach the mount back onto the firewall once the engine is secure. This is also helpful with the Evolution .61 as the needle valve will need to be removed to access the left rear screw.

□ Step 5

Use a felt-tipped pen to mark the firewall in the area that will allow the throttle pushrod line up with the carburetor throttle arm.



□ Step 6

Use a drill and 5/32" (4mm) drill bit to drill the location for the throttle pushrod tube.

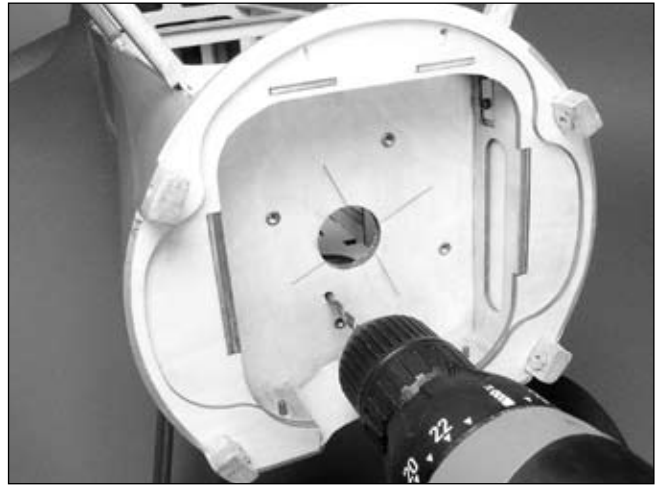

Hint: You may have to remove the engine from the firewall as shown. Even better is to have an extended length drill bit that can reach back to the firewall.

□ Step 7

Roughen the throttle pushrod tube using medium grit sandpaper. Wipe the tube down using rubbing alcohol and a paper towel to remove any oils from the tube. Slide the tube into the hole in the firewall, leaving about 1/2" (13mm) protruding from the firewall. Use medium CA to glue the tube to the firewall.

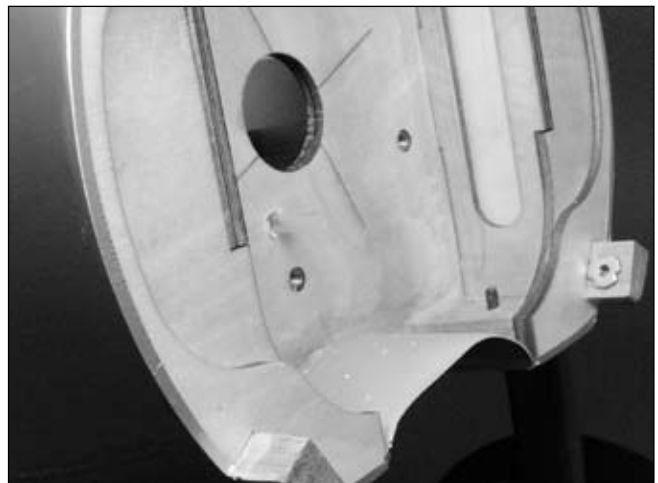

Section 3A: Engine Installation

□ Step 8

Use side cutters to trim the throttle pushrod tube at the front edge of the servo tray.



□ Step 9

Place a clevis retainer onto a nylon clevis. Thread the clevis about 14 turns onto the throttle pushrod wire.

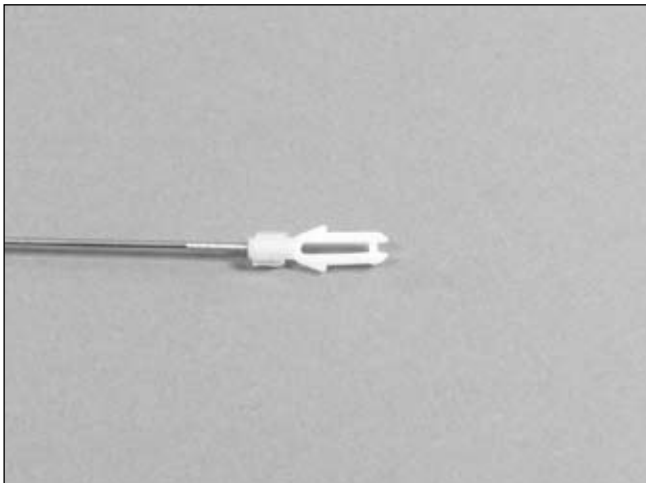

□ Step 10

Slide the throttle pushrod into the throttle pushrod tube. Attach the clevis to the throttle arm of the engine.

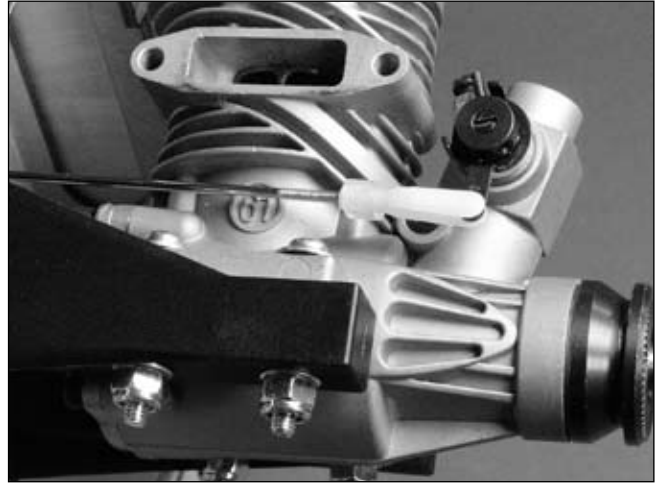

□ Step 11

Attach the muffler to the engine. Adjust the output of the muffler so it faces down and away from the fuselage. Use the instructions provided with your engine for this procedure.

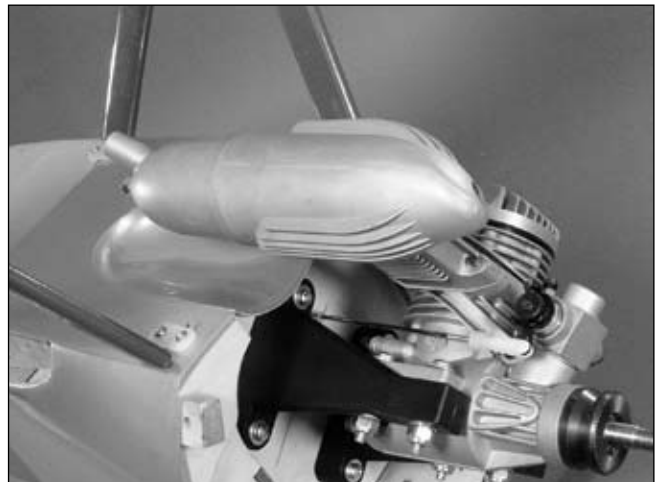

Section 3A: Engine Installation

□ Step 12

Place the two tie wraps into the fuselage as shown. Make sure you will be able to access them once the fuel tank has been placed into the fuselage, as these will hold the tank in position.

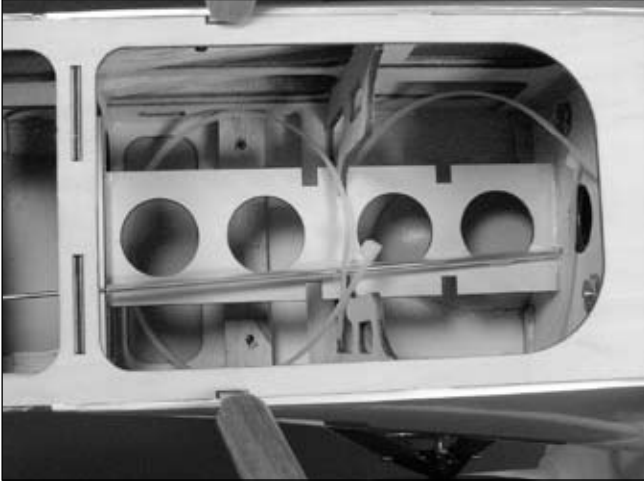

□ Step 13

Place the fuel tank into the fuselage. The stopper in the tank faces towards the bottom of the fuselage. Slide the stopper into the opening of the firewall. Secure the fuel tank using the tie wraps placed in the fuselage in the previous step.

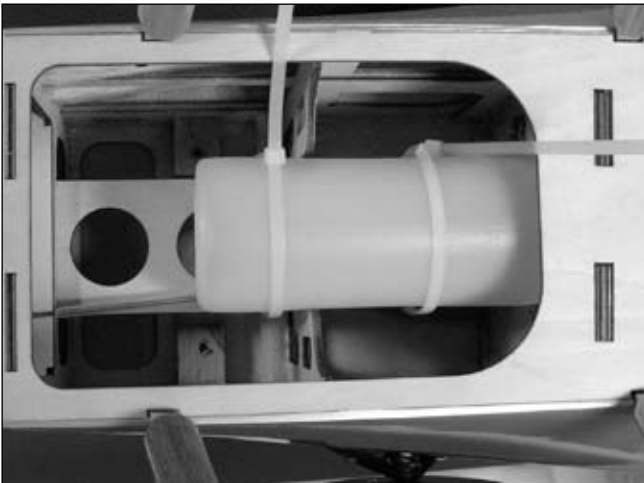

Hint: Trim the excess tie wraps using side cutters for a cleaner installation of the fuel tank.

□ Step 14

Connect the lines from the fuel tank to the engine. The red tube goes to the needle valve, while the green tube goes to the muffler. Trim the length of the tube as necessary to prevent them from getting entangled with the engine or pushrod.

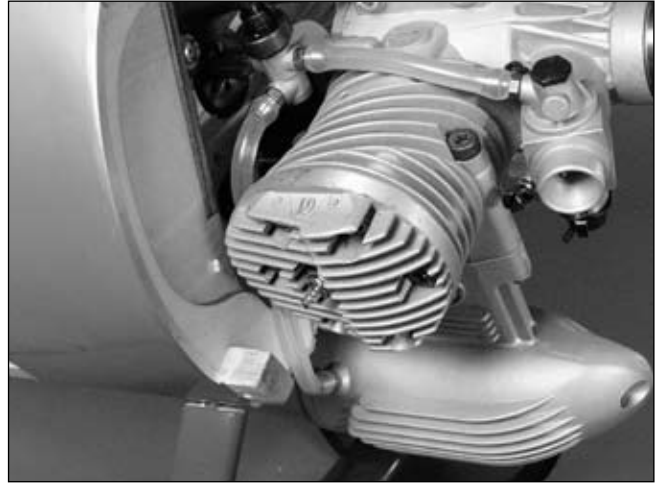

Hint: You can install a fuel filler valve between the fuel tank and engine to make fueling easier.

Section 3B: Electric Motor Installation

Required Parts

- Fuselage
- 8-32 washer (8)
- Motor mount front
- 8-32 x 1/2" machine screw (4)
- 8-32 x 1/2" socket head screw (4)
- Motor mount side (2)
- 8-32 locknut (4)

Required Tools and Adhesives

- Phillips screwdriver
- Hex wrench: 7/64"
- Soldering iron
- Female Deans connector w/wire
- Male Deans connector (3)
- Threadlock
- Adjustable wrench
- Solder

□ Step 1

Attach the motor mount to the firewall using the four 8-32 x 1/2" machine screws and four 8-32 washers. Apply threadlock on the screws to prevent them from vibrating loose.

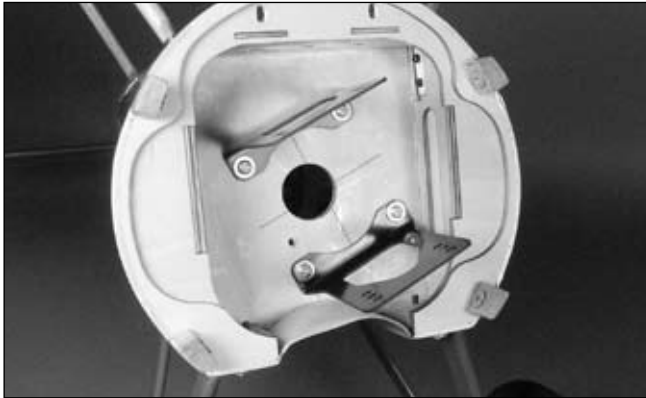

□ Step 2

Depending on your motor selection, you'll need to have the motor output shaft protruding through the non-rotating end of the motor. Follow the instructions included with your motor if necessary to relocate the output shaft.



□ Step 3

Mount the motor to the motor mount front using hardware included with the motor.



□ Step 4

Attach the motor mount front to the motor mount sides using four 8-32 x 1/2" socket head screws, four #8 washers and four 8-32 lock nuts. Position the motor mount front so it is 5" (127mm) from the firewall.



Section 3B: Electric Motor Installation

□ Step 5

Build a wiring harness for the batteries using a female connector and two male connectors. Follow the wiring in the photo so the motor sees the voltage increase of the two batteries.



□ Step 6

Solder the appropriate connectors onto the speed control.



Note: If you only plan on using this controller in your Sopwith, you can combine Steps 5 and 6 by incorporating the harness with the speed control so the controller is positioned in place of the single female connector.

□ Step 7

Plug the motor into the speed control. Secure the batteries using the hook and loop strap. Plug the speed control into the receiver. Mount the speed control inside the fuselage so it will not interfere with the installation and removal of the batteries.



Note: Apply a piece of hook and loop (not included) in the batteries and battery tray if you find the batteries slide forward or aft.

□ Step 8

Turn on the radio system. Plug the wiring harness assembled in Step 5 into the batteries and speed control. Use the throttle on the transmitter to check that everything is working correctly. Check that the motor is rotating counter-clockwise. If not, follow the directions included with the speed control to correct the situation.

□ Step 9

Once the motor is working and rotating in the correct direction, unplug the wiring harness for safety.

Section 4: Cowling Installation

Required Parts

- Fuselage assembly
- Dummy radial engine
- 4-40 x 1/2" socket head screw (4)
- Cowling
- #4 washer (4)

Required Tools and Adhesives

- 6-minute epoxy
- Hobby knife
- Drill bit: 1/8" (3mm)
- Cardstock
- Hobby scissors
- Drill
- Masking tape
- Felt-tipped pen

The installation of the cowling will complete the main fuselage assembly. We can then move along to getting the wings prepped and installed.

□ Step 1

Use a hobby knife and hobby scissors to trim the material from between the cylinders and from the center of the dummy radial engine.



□ Step 2

Test fit the cowling onto the fuselage. Make any marks necessary to fit the cowling over the engine. Use hobby scissors and a rotary tool with a sanding drum to trim the cowl to fit.



□ Step 3

Once the cowl has been trimmed, use 6-minute epoxy to glue the dummy radial into the cowling. Once the epoxy fully cures, trim the radial engine as necessary to fit over the engine.



Section 4: Cowling Installation

□ Step 4

Cut four strips of card stock and make a 1/8" (3mm) hole in the end of each. Tape the card stock onto the fuselage so the holes align with the holes in the cowl mounting blocks.

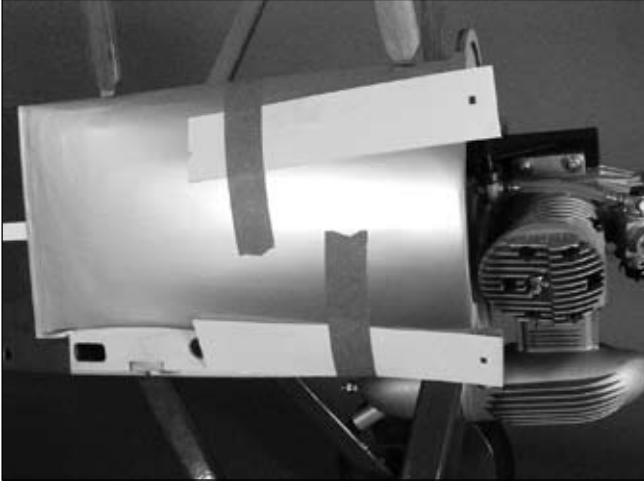

□ Step 5

Position the cowling onto the fuselage. Trim the dummy radial engine as necessary to fit over the engine. The cowl should fit onto the fuselage so the drive washer extends about 1/8" (3mm) or so in front of the dummy radial. Use a felt-tipped pen to transfer the position for the cowl mounting screws onto the cowl.

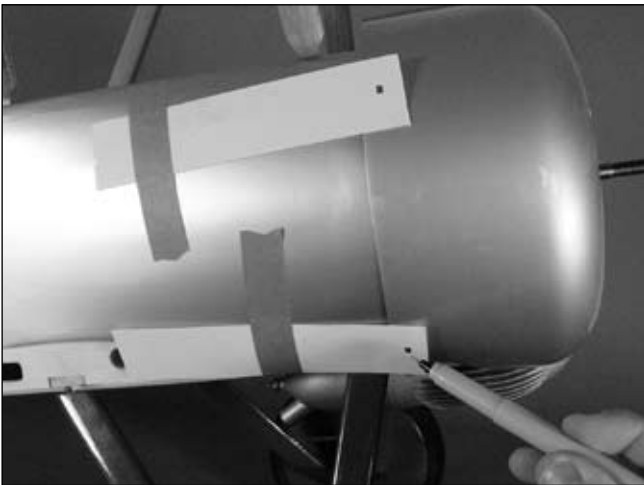

□ Step 6

Drill the holes in the cowl for the mounting screws using a 1/8" (3mm) drill bit. Slide a #4 washer onto a 4-40 x 1/2" socket head screw. Secure the cowling using four of the 4-40 x 1/2" socket head screws.



Note: Cut a thin 5/64" (2mm) piece of the fuel tubing to slide on the screw following the washer. This will help prevent the screws from vibrating loose.

□ Step 7

Install an appropriate propeller for your selected engine.



Section 5: Aileron Servo Installation

Required Parts

- Bottom wing (R&L)
- 5/8" x 7/16" x 7/16" (16mm x 11mm x 11mm) aileron servo block (4)
- 2mm x 10mm sheet metal screw (8)
- Control horn w/backplate (2)
- 2mm x 20mm sheet metal screw (6)
- 3³/₈" (86mm) threaded pushrod wire (2)
- Nylon clevis w/retainer (2)
- Pushrod connector (2)

Required Tools and Adhesives

- Aileron servo (2)
- 6-minute epoxy
- Felt-tipped pen
- Drill
- Side cutters
- Hobby knife
- Phillips screwdriver
- Servo extension, 18" (457mm)
- Drill bit: 1/16" (1.5mm), 3/32" (2.5mm)

Although there are four ailerons to deal with, you will only have to install two servos. As such, make sure to use quality servos, as each servo will be operating two ailerons.

□ □ Step 1

Plug one of the aileron servos into the receiver. Turn on the radio and the receiver and center the aileron stick and trim. Install a long servo horn onto the servo. Attach an 18" (457mm) servo extension onto the servo lead. Use thread or a commercially available connector to keep the extension from unplugging from the servo lead.

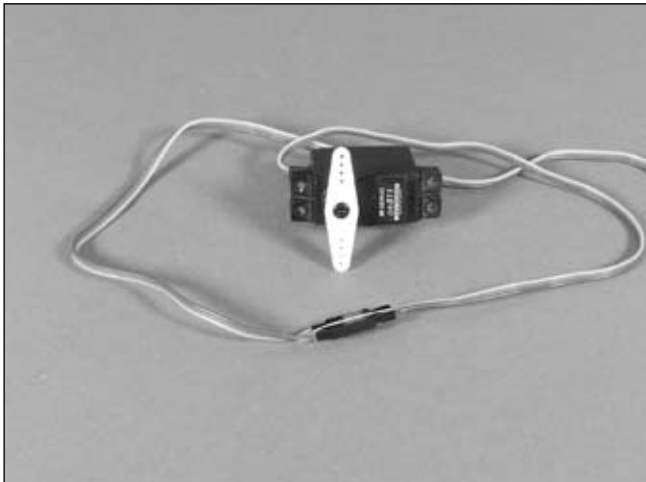

□ □ Step 2

Remove the servo hatch from the wing. Place the servo onto the hatch, centering the servo arm in the opening. Also position the servo so the centerline of the arm is aligned with the edge of the hatch to prevent interference between the arm and the wing or hatch. Use a felt-tipped pen to transfer the location of the servo onto the hatch.

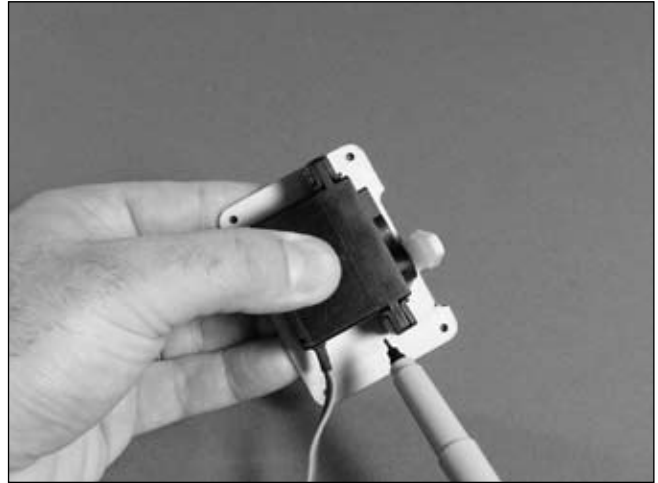

□ □ Step 3

Position the blocks onto the hatch. Check to make sure that neither block extends beyond the hatch, preventing the hatch from being installed. If so, move the offending block fully onto the hatch, position the servo back onto the hatch, and mark a new location for the remaining block.

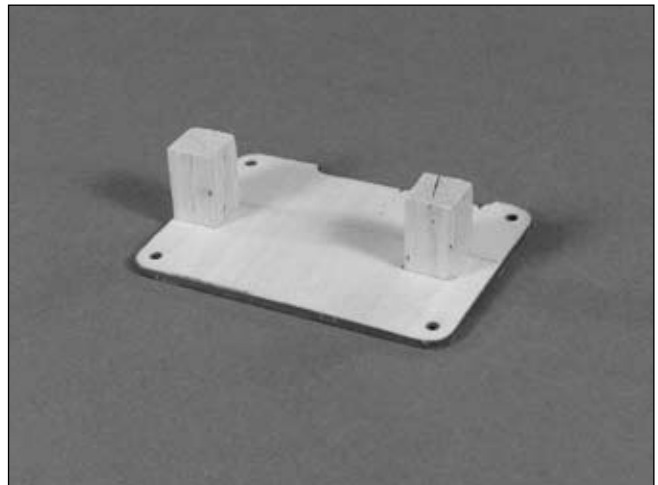

Section 5: Aileron Servo Installation

□ □ Step 4

Once the blocks have been positioned and the servo will fit between the block, use 6-minute epoxy to glue the blocks securely to the hatch.

Note: The block must be glued to the hatch so they won't pop loose. Remember we have the load of two ailerons being transferred to the servo and blocks, not just one.

□ □ Step 5

Once the epoxy has fully cured, position the servo back onto the servo hatch between the blocks. Use a felt-tipped pen to mark the location for the servo mounting screws.

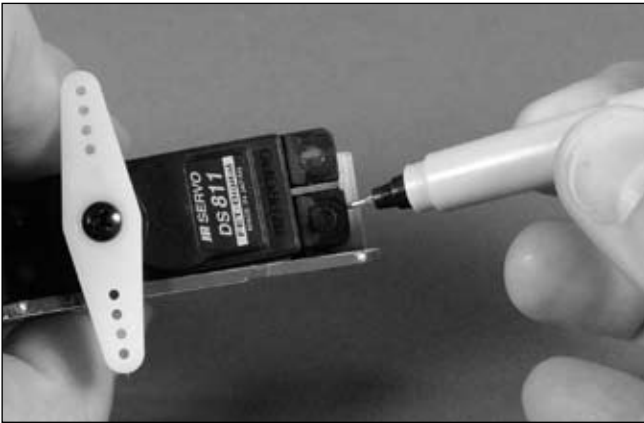

□ □ Step 6

Use a 1/16" (1.5mm) drill bit to drill the four locations marks in the previous step. Attach the servo to the blocks using the screws provided with the servo. Use side cutters to trim the excess arm so only the portion of the servo arm extending to the outside of the hatch remains.

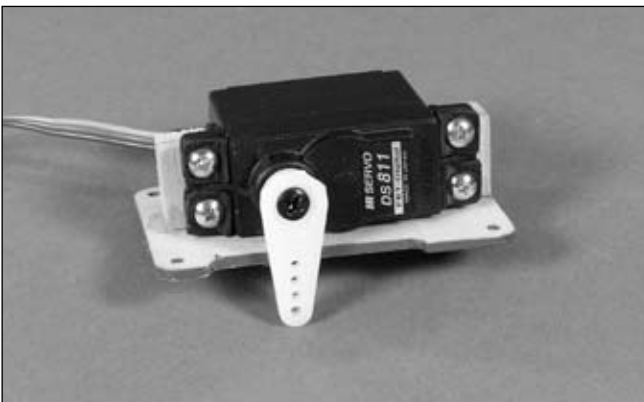

□ □ Step 7

Thread a clevis onto one of the longer pushrod wires. Pass the wire into the wing. Attach the servo extension to the clevis and pull it through the wing.

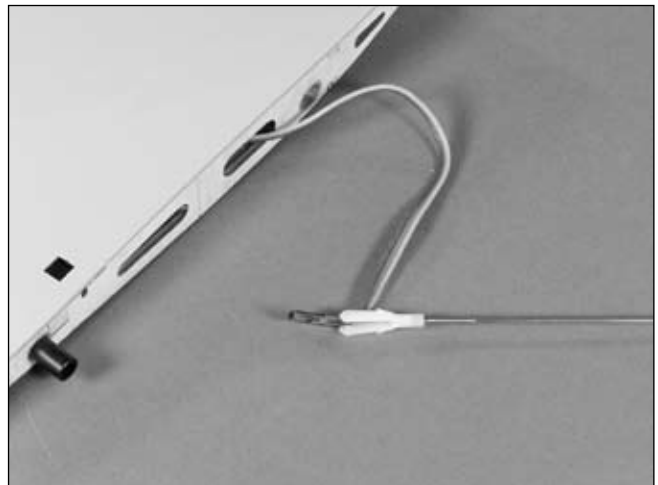
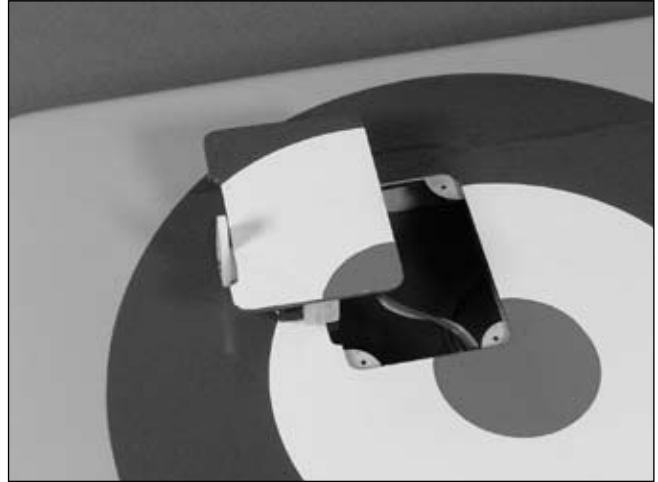

Hint: You can tie a weight to a string and use that as well to pull the servo lead through the wing.

Section 5: Aileron Servo Installation

□ □ Step 8

Secure the servo hatch to the wing using four 2mm x 10mm sheet metal screws.

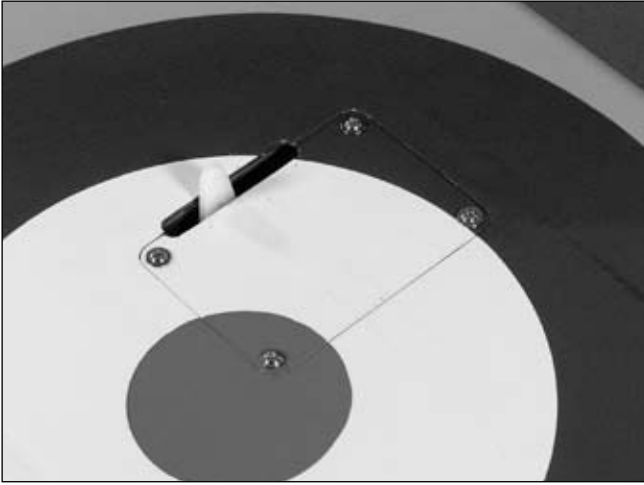

Hint: Use a T-pin to poke through the covering on the backside of the hatch to leave indications where the holes are in the hatch.

□ □ Step 9

Locate the $3\frac{3}{8}$ " (86mm) pushrod wire, nylon clevis and clevis retainer. Slide the retainer onto the clevis, and then thread the clevis about 14 turns onto the pushrod wire.

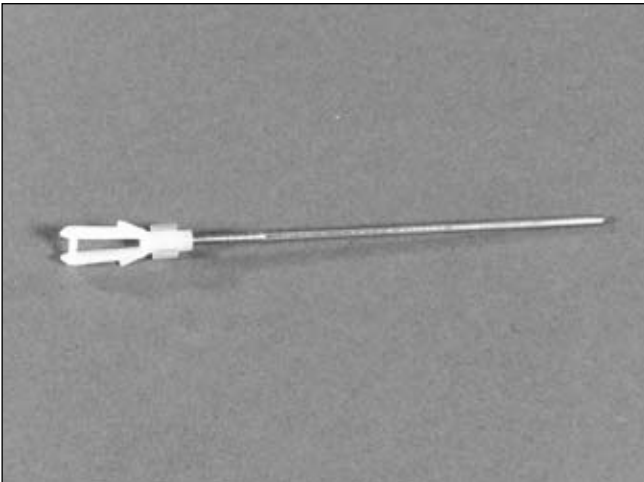

□ □ Step 10

Remove the backplate from the control horn using a sharp hobby knife. Attach the clevis to the middle hole of the control horn. Position the horn onto the wing so the holes in the horn align with the hinge line of the aileron. The pushrod wire will run to the outside of the servo horn and be parallel to the horn as well. Use a felt-tipped pen to mark the locations for the three control horn mounting screws.



□ □ Step 11

Drill the three locations for the control horn screws using a $\frac{3}{32}$ " (2.5mm) drill bit. Apply a couple drops of thin CA into each of the holes to harden the underlying balsa.



Section 5: Aileron Servo Installation

□ □ Step 12

Attach the control horn to the aileron using three 2mm x 20mm sheet metal screws and the control horn backplate.

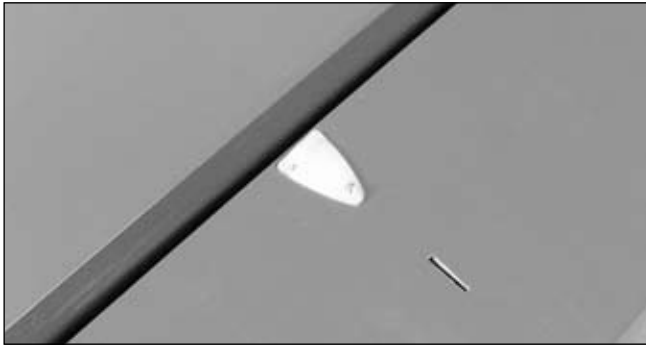

□ □ Step 13

Make sure the aileron servo is centered using the radio system. Center the aileron and use a felt-tipped pen to mark the aileron pushrod where it crosses the servo arm.



Hint: Wrap a small piece of low-tack tape around the aileron and wing to hold the aileron in the neutral position. This will come in handy when installing the linkage between the upper and lower ailerons.

□ □ Step 14

Use pliers to bend the pushrod at a 90-degree angle at the mark made in the last step. Enlarge the holes in the servo arm using a 5/64" (2mm) drill bit. Pass the bend through the outer hole and secure the pushrod wire to the arm using a pushrod connector.



Hint: Use side cutters to remove the excess pushrod wire. Use a file to smooth the end of the cut so it doesn't snag on your shirt or skin.

□ Step 15

Repeat Steps 1 through 14 for the remaining aileron servo.

Section 6: Bottom Wing Installation

Required Parts

- Bottom wing (R&L)
- Wing tube
- 4-40 x 1/2" socket head screw (4)
- #4 washer (4)

Required Tools and Adhesives

- Drill
- Drill bit: #43
- 4-40 tap
- Threadlock

Installing the bottom wing isn't tricky, but will require drilling and tapping a couple of holes. Once the bottom wing is in place, we can move on to installing the top wing, making this look more like a biplane.

□ Step 1

Slide the wing tube into one of the bottom wing panels. Carefully drill a #43 hole into the wing tube, being careful not to damage the wing.



□ Step 2

After drilling the hole, use a 4-40 tap to tap the hole for the screw.



Hint: It is easier to leave the tube in position when tapping the hole. This will make lining up the hole in the wing much easier in the following step.

□ Step 3

Use a 4-40 x 1/2" socket head screw and #4 washer to secure the tube into the wing. Place a drop of threadlock on this screw only, as you will probably not remove this in the future.



Section 6: Bottom Wing Installation

□ Step 4

Slide the wing (and tube) into the fuselage. Carefully push the wing tight against the fuselage, and then use a #43 drill to drill for the anti-rotation screw through the hole in the fuselage. Again, use care not to let the drill bit slip and damage the fuselage or wing.

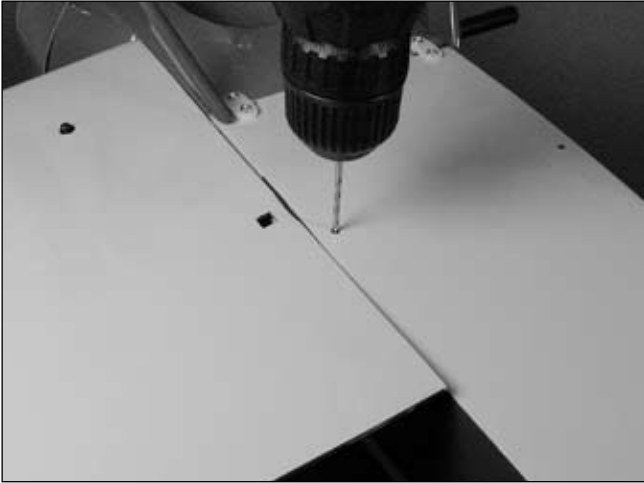

□ Step 5

Use a 4-40 tap to thread the hole. Secure the wing to the fuselage using a 4-40 x 1/2" socket head screw and a #4 washer.

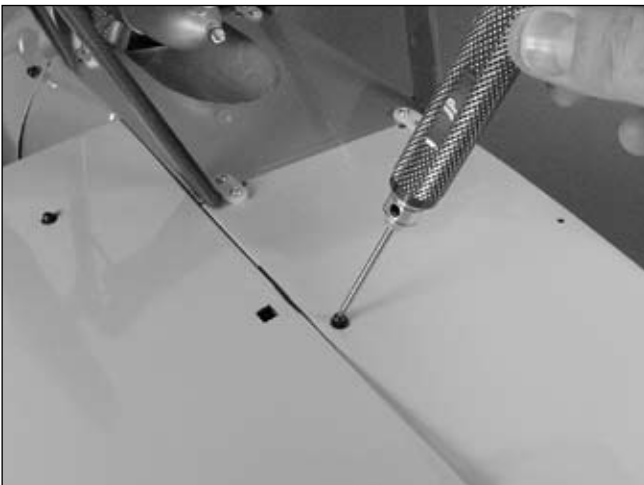

□ Step 6

Slide the remaining wing panel into position. While holding it tight against the fuselage, drill the hole for the wing tube and the anti-rotation pin. After threading both holes, secure the wing using two 4-40 x 1/2" socket head screws and two #4 washers.

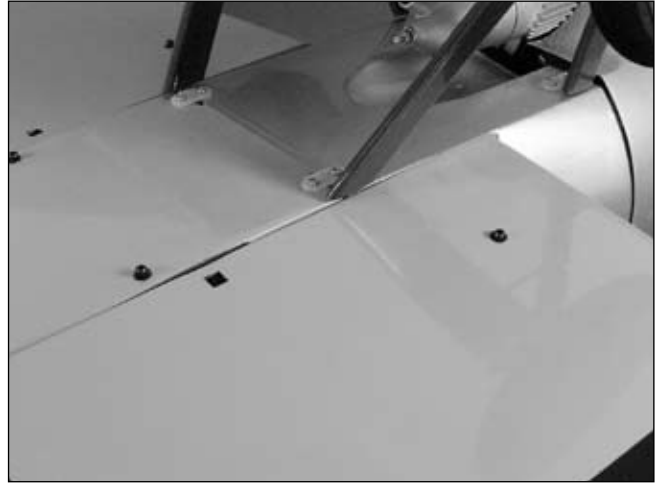

Hint: When removing the bottom wing, remove the three socket head screws that do not have threadlock. Leaving the final screw in place will save you some time in trying to line up the hole with the screw in the wing tube.

Section 7: Top Wing Installation

Required Parts

- Covering (green)
- 4-40 locknut (8)
- Top wing (R&L)
- Wing joiner (5 7/8" x 1/2" x 3/16") (150mm x 13mm x 5mm)
- Joiner dowel (1/4" x 2 3/8") (6mm x 60mm)
- 4-40 x 1/2" socket head screw (12)
- 4-40 x 5/8" socket head screw (8)
- Interplane strut (long) (2)
- Interplane strut (short) (2)
- Interplane bracket (8)
- Aileron slave linkage control horn (grey) (2)
- Aileron slave linkage control horn (green) (2)
- Aileron slave linkage (2)
- Nylon clevis w/retainer (4)
- Covering (grey)
- #4 washer (4)

Required Tools and Adhesives

- 30-minute epoxy
- Rubbing alcohol
- Masking tape
- Threadlock
- 6-minute epoxy
- Paper towel
- Sandpaper

Now comes the fun part: The top wing installation! This will include joining the wing, installing the interplane struts, and the installation of the aileron joining linkage. It's a good idea to grab your favorite beverage and work slowly through this, as it will take a fair amount of time to complete.

□ Step 1

Locate the wing joiner and the joiner dowel. Test fit them into one of the top wing panels.

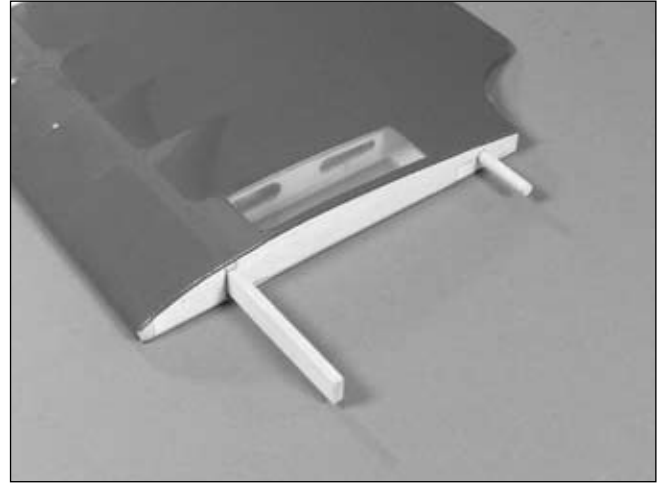

□ Step 2

Test fit the remaining panel onto the joiner and dowel. The two panels should fit tightly together. Sand the joiner if necessary so the two panels fit together as tightly as possible.

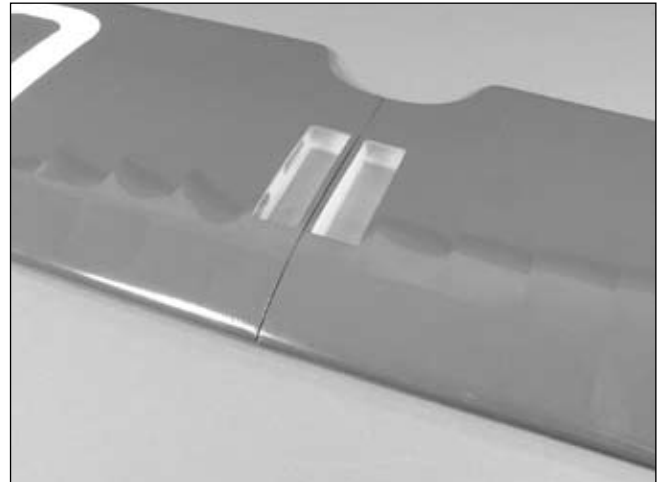

Note: Make sure you can perform the following step in the amount of time it takes for the epoxy to cure. You may want to glue the joiner and dowel in one panel and clean up the excess epoxy if you work slowly to prevent having the two panels out of alignment or not joined tightly together.

Section 7: Top Wing Installation

□ Step 3

Once the two panels have been fit together, mix up about 1/2 oz (15ML) of 30-minute epoxy. Apply the epoxy to all sides of the joiner and to the joiner dowel. Also apply epoxy to the openings in the panels where the joiner and dowel fit. Slide the joiner and dowel into the panel. Then slide the remaining panel into position. Use a paper towel and rubbing alcohol to remove excess epoxy. Use tape to hold the two panels together until the epoxy fully cures.

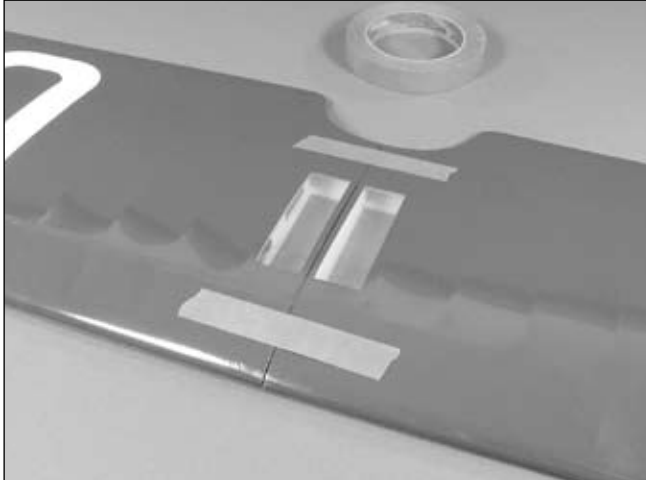

□ Step 4

Attach four interplane brackets to the bottom of the top wing using four 4-40 x 1/2" socket head screws. The brackets face towards the wing tip of their respective wing panels. Leave the screws slightly loose for now so the brackets can be adjusted when installing the interplane struts.

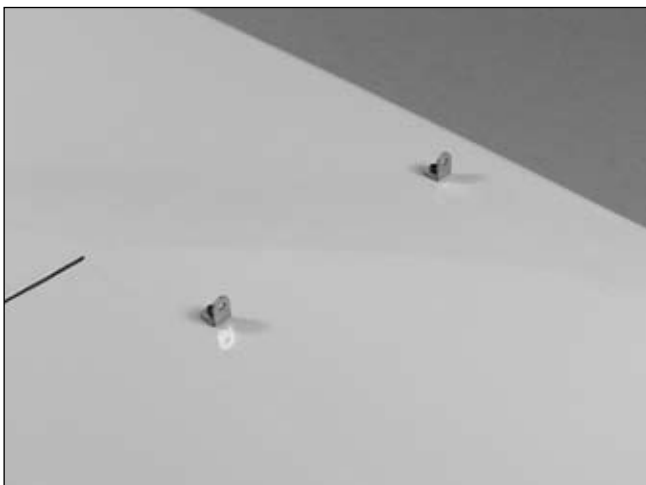

Note: The squared end of the bracket is the one the screw goes through to attach to the wing.

Hint: If you are planning on installing the rigging between the top and bottom wings, you may want to take a quick look at Section 10: Rigging Installation before installing the brackets and attaching the top wing to the cabane struts.

□ Step 5

Attach four interplane brackets to the top of the bottom wing using four 4-40 x 1/2" socket head screws. The brackets face towards the wing tip of their respective wing panels. Leave the screw slightly loose for now so the brackets can be adjusted when installing the interplane struts.



Section 7: Top Wing Installation

□ Step 6

Use four 4-40 x 1/2" socket head screws to attach the top wing to the cabane struts.

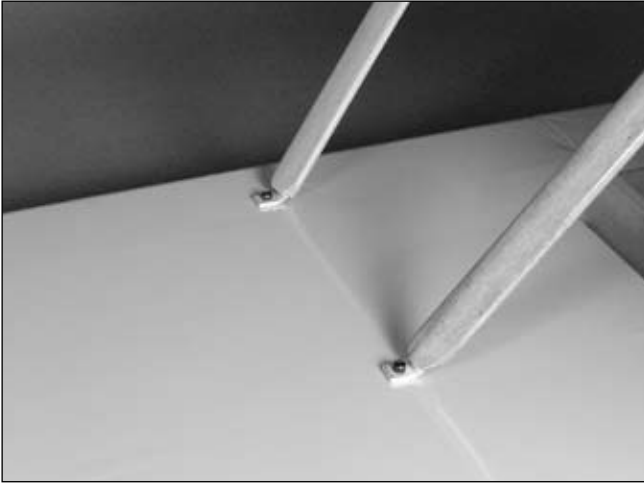

□ Step 7

Locate the interplane struts. There are two shorter struts that are positioned at the leading edge of the wing. The two shorter struts positioned at the trailing edge of the wing. Install the interplane struts between the top and bottom wing using eight 4-40 x 5/8" socket head screws and eight 4-40 locknuts.



Note: Once the struts have been attached, check that they are in line with each other. This is done by tweaking the brackets slightly. Once aligned, the brackets can be fully tightened and threadlock placed on each of the screws holding the brackets to the wing.

□ Step 8

Lightly sand the bottom of the aileron slave linkage control horns to remove the paint where they will be inserted into the wing.

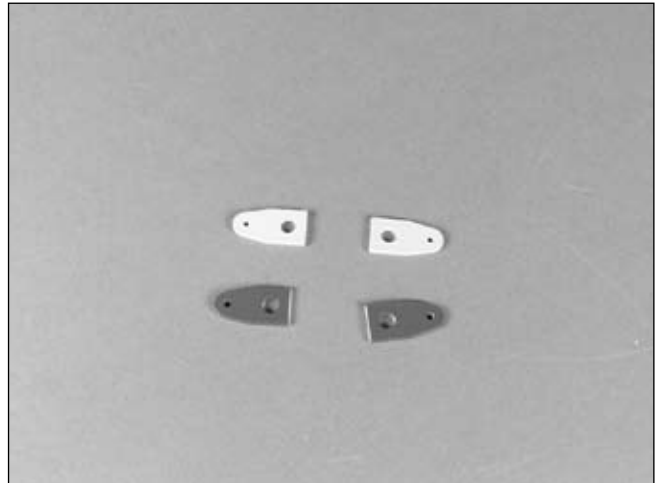

Section 7: Top Wing Installation

□ Step 9

Use 6-minute epoxy to glue the aileron slave linkage control horns into the slots in the upper and lower ailerons. Remember to place the green horn into the top of the ailerons so it blends with the covering on the wing.



Note: Be careful not to push the horn through the opposite side of the ailerons.

□ Step 10

Complete the aileron slave linkage by placing a clevis retainer onto a clevis. Thread the clevis onto the threaded end of the linkage. Repeat for both ends of the linkage.

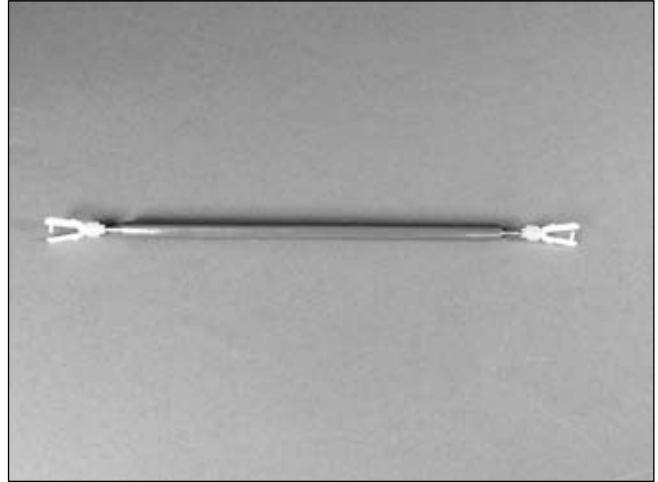

□ Step 11

With the radio system on and the aileron servos operating, attach the slave linkage to the bottom aileron. Thread the clevises either in or out so when the top clevis is in position, the top aileron is centered.

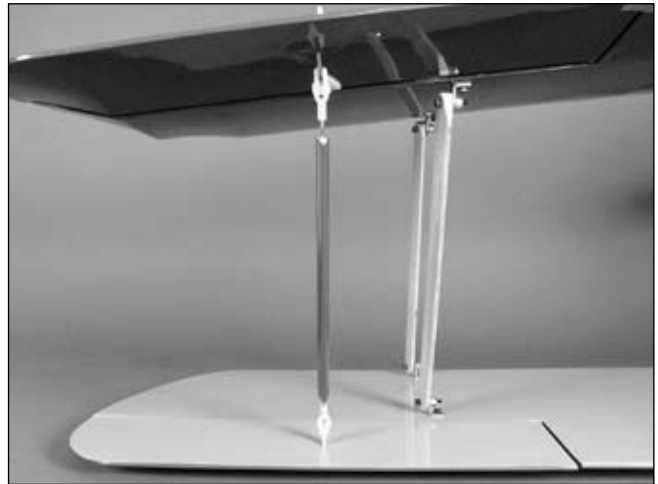

Section 8: Tail Installation

Required Parts

- Rudder
- Elevator (2)
- Fin
- Stabilizer
- CA hinge (9)

Required Tools and Adhesives

- 30-minute epoxy
- Paper towel
- Rubbing alcohol
- Hobby knife
- T-pins
- Drill
- Drill bit: 1/16" (1.5mm)

This is the last major airframe assembly before moving on to the radio installation and installing the rigging. After installing the tail, you'll get to see exactly what your Sopwith looks like.

□ Step 1

Locate the stabilizer and fin. Remove the tape holding the elevators from the stabilizer, and the tape holding the rudder to the fin.

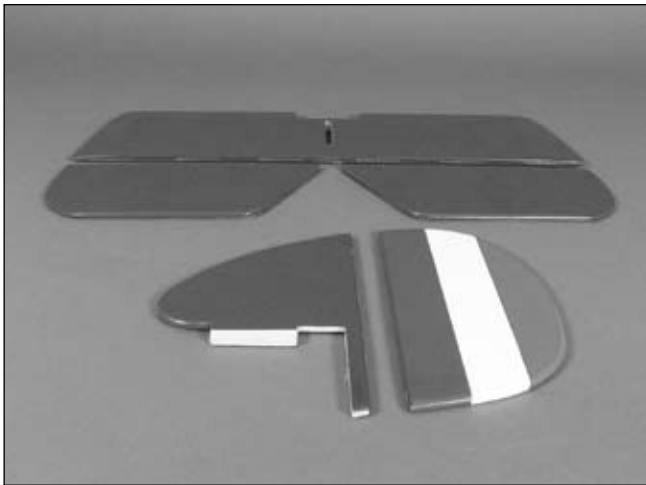

□ Step 2

Test fit the tab from the fin into the slot in the stabilizer. Use a square to check the alignment of the fin to the stabilizer. Lightly sand the tab on the fin if necessary for alignment purposes.

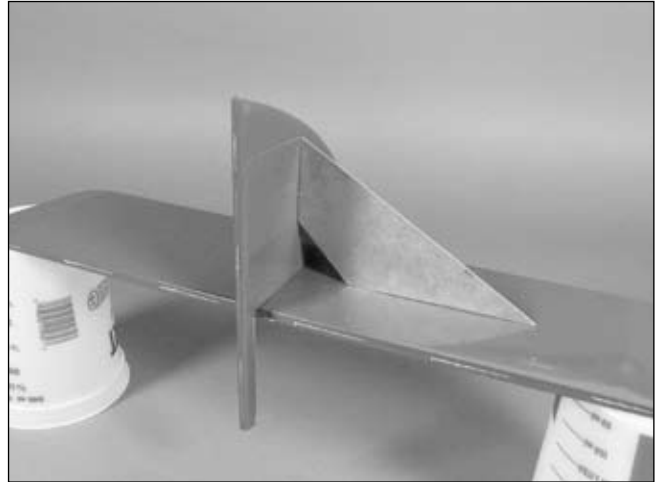

□ Step 3

Use 30-minute epoxy to glue the fin and stabilizer together. Check that they stay perpendicular to each other while the epoxy cures.

□ Step 4

Carefully remove about the first 1/8" (3mm) of covering from the forward edge of the fin below the stabilizer as shown.

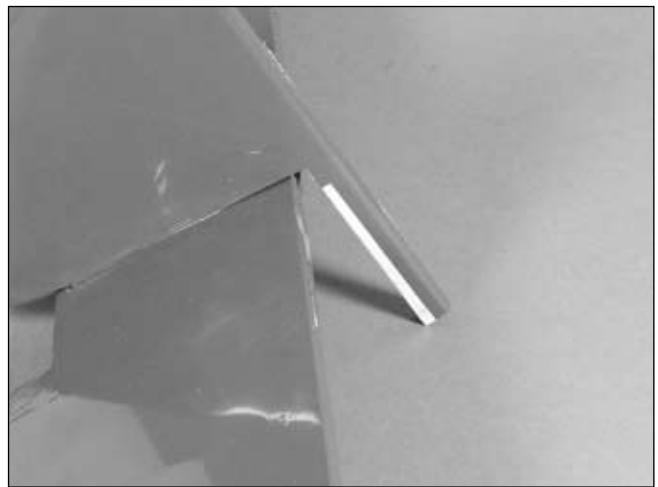

Section 8: Tail Installation

□ Step 5

Carefully remove the covering from the stabilizer saddle on the fuselage. Do not change the shape of the saddle by accident.



□ Step 6

Slide the stabilizer assembly onto the fuselage. Check that the stabilizer is parallel to the wings, and that the fin runs down the centerline of the fuselage.

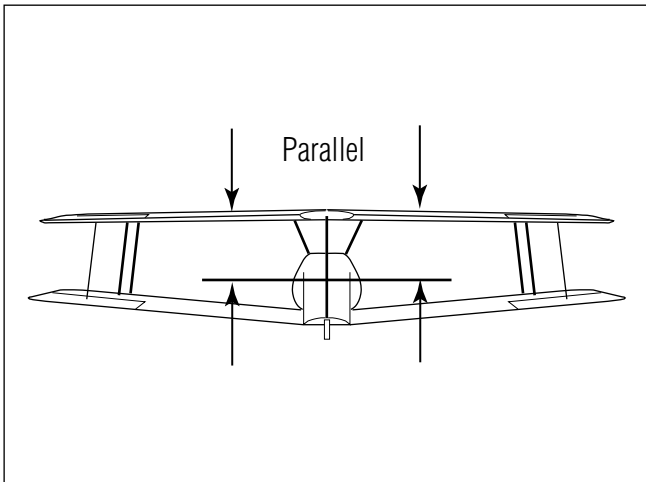

Hint: It is easier to reference the top wing and stabilizer as the top wing has less dihedral than the bottom wing.

□ Step 7

Use a felt-tipped pen to trace the outline of the fuselage onto the bottom of the stabilizer. Also trace the top of the fuselage where it meets the stabilizer.

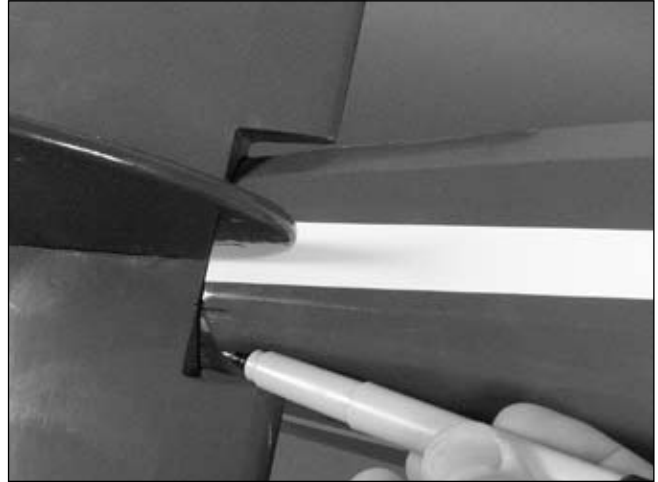

Note: You will want to have as much gluing surface as possible to secure the stabilizer to the fuselage.

Section 8: Tail Installation

□ Step 8

Use a sharp hobby knife to remove the covering 1/16" (1.5mm) inside the lines drawn on the stabilizer.

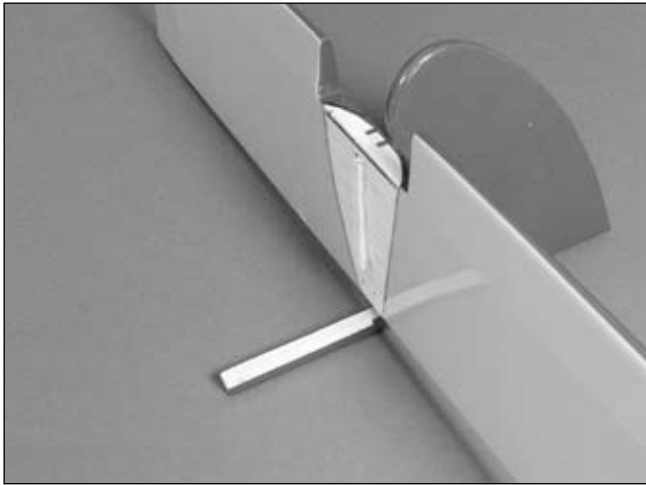

Important: DO NOT cut into the stabilizer. Use very light pressure to trim the covering. You can also use a hot knife or soldering iron to remove the covering.

□ Step 9

Mix up 1/2 Oz (15ML) of 30-minute epoxy. Apply the epoxy to the stabilizer saddle, the bare wood on the stabilizer, and onto the fin where it fits into the fuselage. Check the alignment of the stabilizer often to make sure it remains in position while the epoxy cures.

Note: Clean up any excess epoxy using a paper towel and rubbing alcohol.

Hint: Once the epoxy has fully cured, you can take the wings off your Sopwith to make it easier to work on in your work area.

□ □ Step 10

Use a 1/16" (1.5mm) drill bit to drill a hole in the center of each hinge slot in one of the elevators. Drill holes in the corresponding hinge slots for the stabilizer.



□ □ Step 11

Place a T-pin in the center of three hinges.

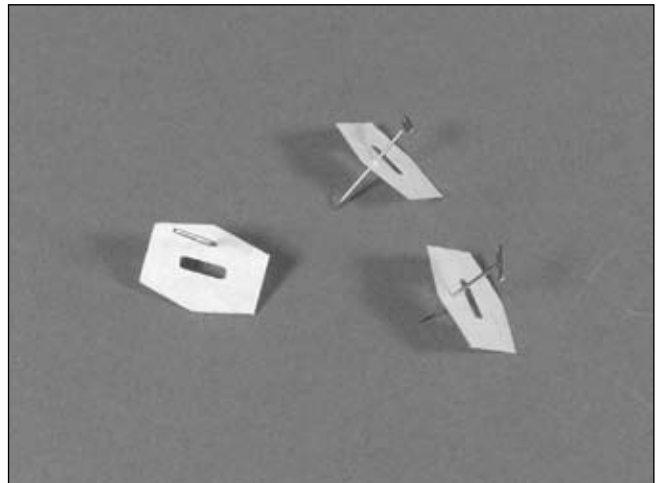

Section 8: Tail Installation

□ □ Step 12

Slide the hinges into the slots in the elevator.

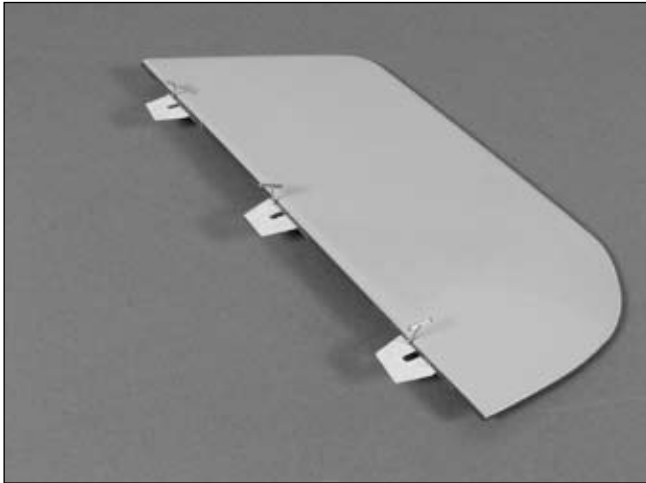

□ □ Step 13

Slide the elevator into position on the stabilizer. Make sure the colors match up, and that the end of the elevator aligns with the stabilizer.

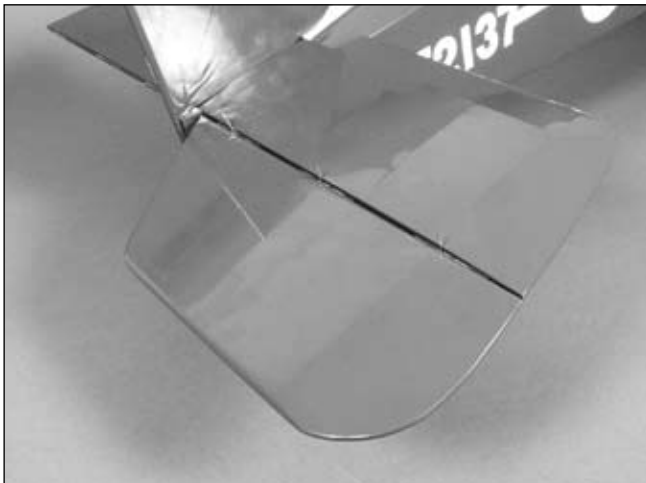

□ □ Step 14

Remove the T-pins from the hinges. Apply thin CA to each of the hinges, both top and bottom.

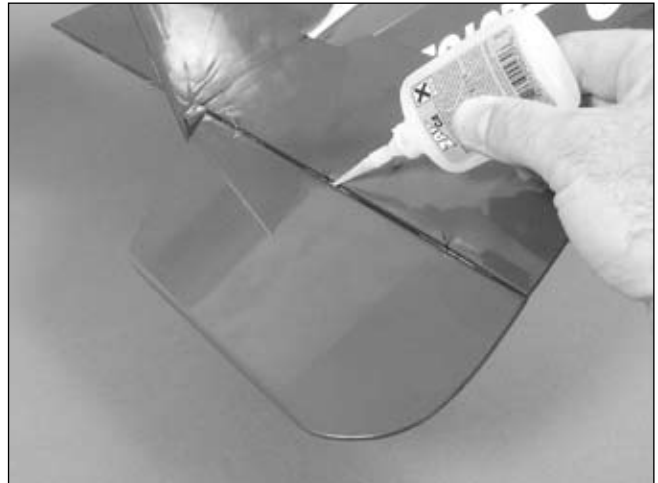

Note: DO NOT use accelerator when gluing the hinges. The CA **MUST** be given time to soak into the hinge to provide the best bond between the hinge and control surface.

□ □ Step 15

Pull on the elevator and stabilizer to check that the hinges are glued securely. Use care not to use too much pressure and damage your aircraft.

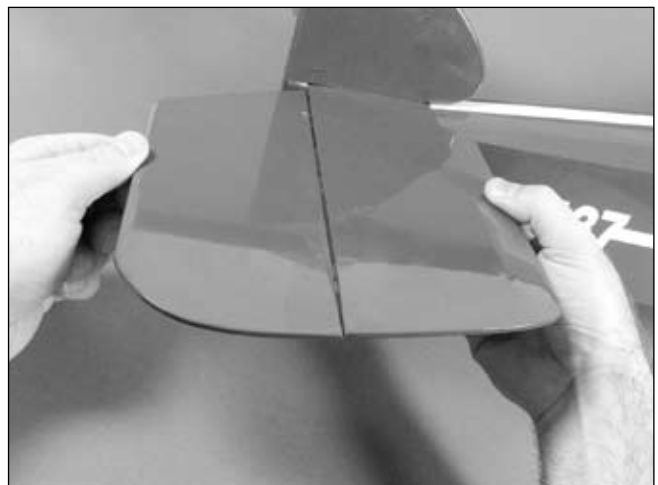

Section 8: Tail Installation

□ □ Step 16

Once the CA has fully cured, flex the elevator up and down a few times to break in the hinges.

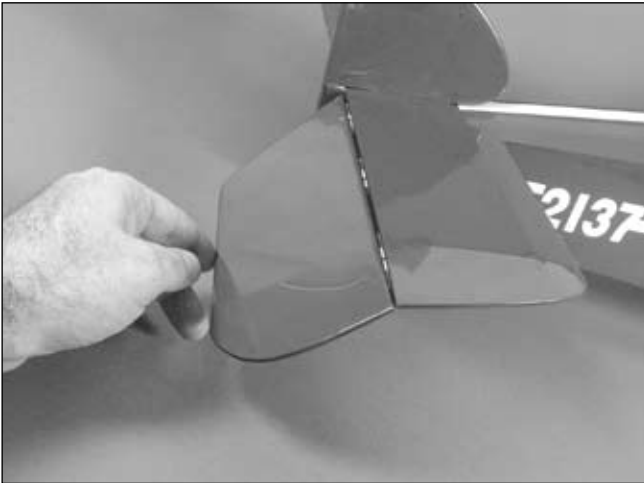
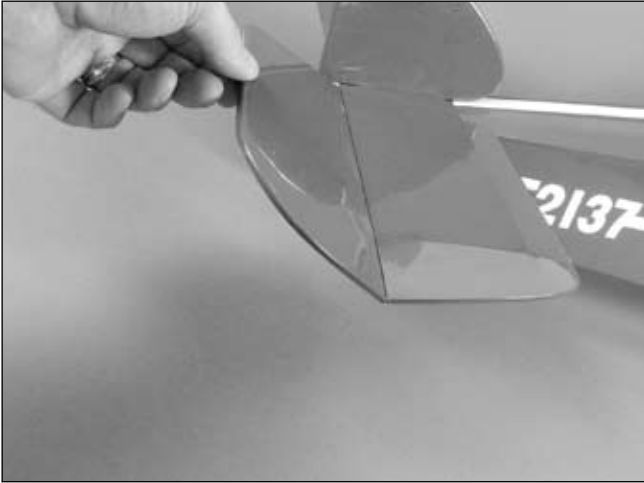

□ Step 17

Repeat Steps 10 through 16 for the remaining elevator hinges and for the rudder hinges.

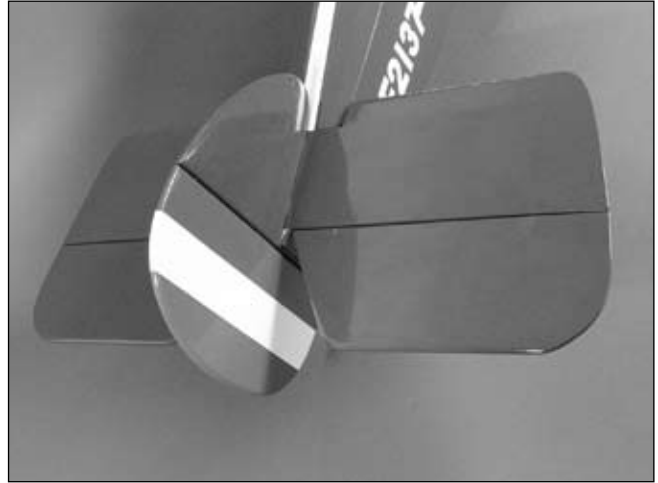

Section 9: Radio Installation

Required Parts

- Fuselage assembly
- Pilot figure
- 22 1/2" (570mm) threaded pushrod
- 22 3/4" (578mm) "Y" threaded pushrod
- Nylon clevis w/retainer (3)
- Pushrod connector (2)
- Control horn w/backplate (3)
- 2mm x 12mm machine screw (9)
- Brass pushrod connector
- Connector backplate
- 3mm x 6mm machine screw

Required Tools and Adhesives

- Standard servo w/hardware (3)
- Receiver
- Receiver battery
- Phillips screwdriver
- Felt-tipped pen
- Drill bit: 1/16" (1.5mm), 5/64" (2mm), 3/32" (2.5mm)
- Zap-A-Dap-A-Goo
- Switch harness
- Hobby knife
- Drill

We are finally completing the major assembly of your Sopwith Camel. Once you have the radio installed, you should take a nice long break before starting on the rigging.

□ Step 1

Locate the 22 1/2" (570mm) threaded pushrod. Slide the pushrod through the pre-installed tube inside the fuselage. This will be for operating the rudder.

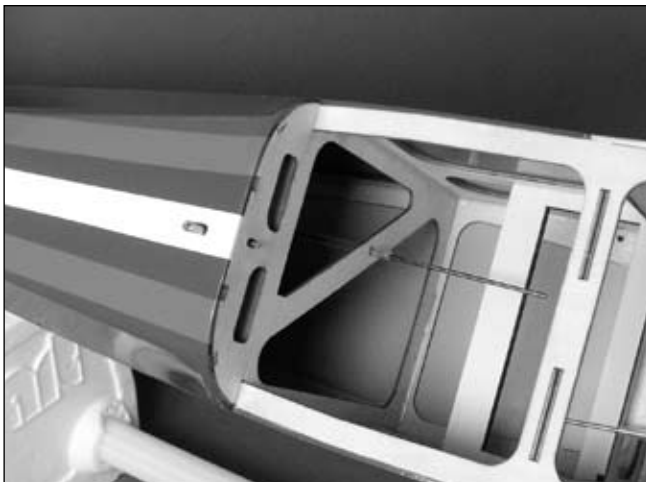

□ Step 2

Locate the 22 3/4" (578mm) "Y" threaded pushrod and slide it into the tubes installed in the fuselage. Take your time as this can be a little tricky. This pushrod will be used for the elevators.



□ Step 3

Slide a clevis retainer onto one of the clevises. Thread the clevis about 14 turns onto one of the threaded ends of a pushrod. Repeat this for all three of the threaded ends of the pushrods.

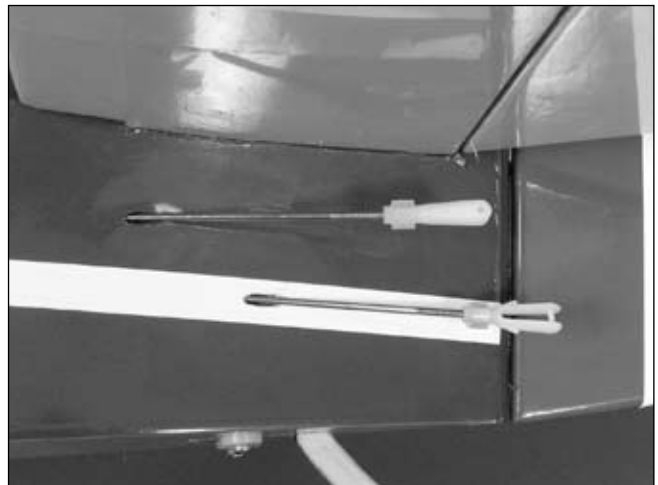

Section 9: Radio Installation

□ □ Step 4

Use a hobby knife to carefully remove the backplate from a control horn. Attach the clevis for the rudder pushrod onto the control horn. Position the horn so the holes for the clevis align with the hinge line. Use a felt-tipped pen to transfer the mounting holes onto the rudder.

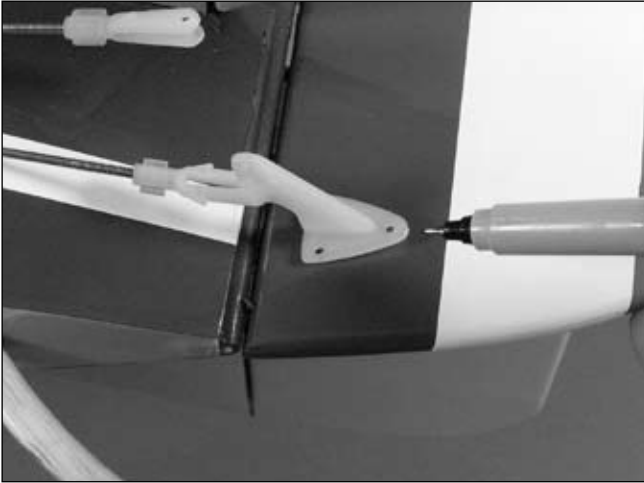

□ □ Step 5

Use the marks made in the last step to drill 3/32" (2.5mm) holes through the rudder for mounting the control horn. Apply a drop or two of thin CA to each hole to harden the underlying balsa.



□ □ Step 6

Secure the control horn to the rudder using three 2mm x 12mm machine screws and the control horn backplate.

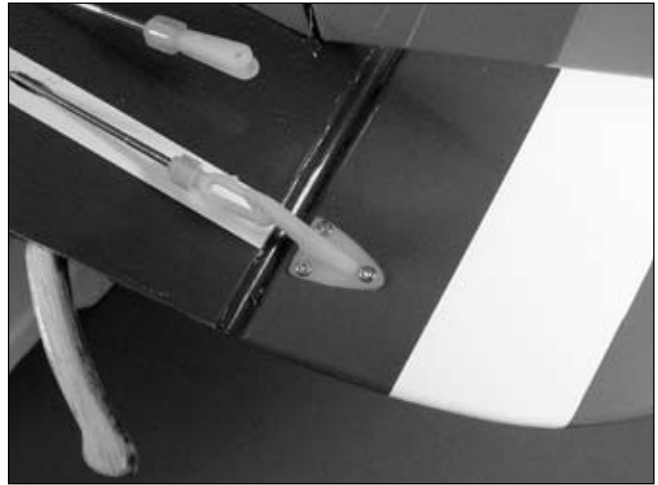

Section 9: Radio Installation

□ Step 7

Repeat Steps 4 through 6 for the elevator control horns. Make sure you position the horns the same for the right and left elevators.



Note: The elevators may not be aligned once the horns are installed. Once the servo has been installed and connected to the pushrod, we'll come back and correct any alignment problems.

□ □ Step 8

Install the grommets and brass eyelets in the servo using the instructions that came with your servo or radio system. Place the rudder servo into the servo tray. Position the servo so the servo horn aligns naturally with the rudder pushrod. Mark the locations for the servo screws using a felt-tipped pen.

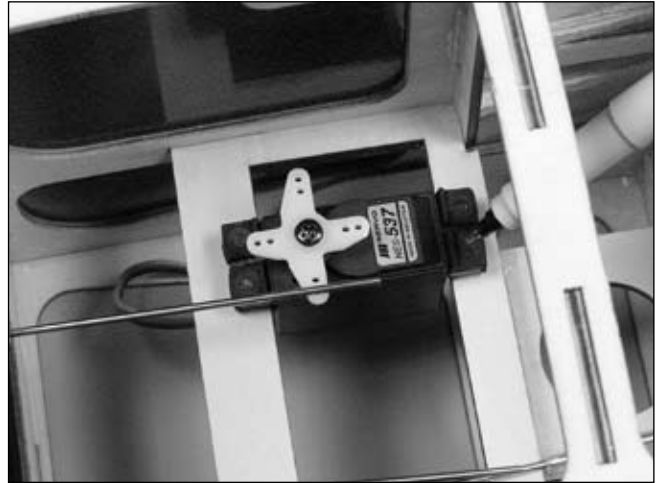

□ □ Step 9

Use a drill and 1/16" (1.5mm) drill bit to drill the locations from the previous step.



Section 9: Radio Installation

□ □ Step 10

Use the hardware provided with the servo to secure its location on the servo tray.

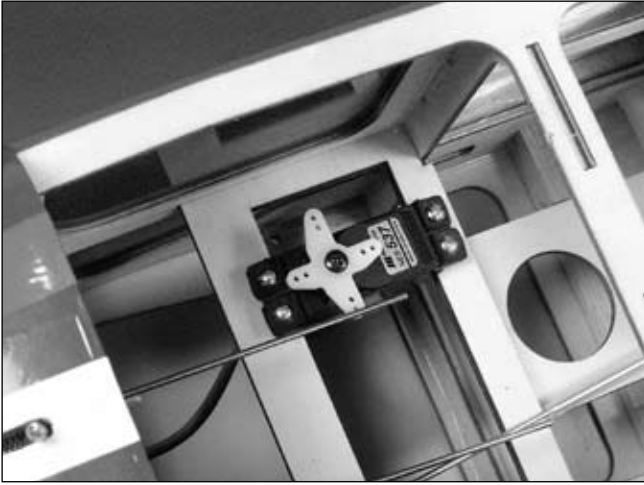

□ □ Step 11

Plug the rudder servo into the receiver. Turn on the transmitter and receiver and center the trim and rudder stick on the transmitter. Position the rudder so it is in line with the fin (neutral). Use a felt-tipped pen to mark the rudder pushrod where it crosses the holes in the servo arm.



□ □ Step 12

Use pliers to bend the rudder pushrod at a 90-degree angle at the mark made in the last step. Enlarge the holes in the servo arm in the vicinity of the pushrod using a 5/32" (2mm) drill bit. Pass the pushrod through the servo arm and use a pushrod connector to secure the pushrod to the servo arm.



Note: Trim the excess arms from the servo to prevent them from interfering with the operation of the rudder and associated linkage.

□ Step 13

Repeat Steps 8 though 12 for the elevator servo and linkage. You can center either the right or left elevator half before marking the pushrod wire as described in Step 11.



Section 9: Radio Installation

□ Step 14

The elevator you did not choose to center in the previous step may need to be adjusted. Simply disconnect the clevis from the control horn and thread the clevis in or out until both elevator halves are positioned parallel to each other.



□ Step 15

Use the procedure as described in Steps 8 through 10 to mount the throttle servo into the fuselage. Make sure the servo arm won't interfere with the operation of the rudder or elevator linkages when positioning the throttle servo.



□ Step 16

Plug the throttle servo into the receiver. Turn on the transmitter and receiver and center the throttle stick and trim. Check that the position of the servo arm is as shown in the previous step. If not, remove the arm and move it as such. This will provide an equal amount of throw for both low and high throttle settings, making setting up the linkage easier.

□ Step 17

Remove the arm from the servo and enlarge the holes in the arm that correspond with the linkage (and the last step) using a 5/64" (2mm) drill bit. Slide the brass pushrod connector into the hole and secure it using the connector backplate.

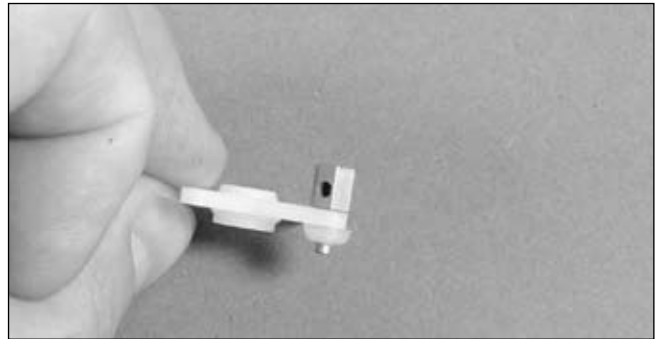

□ Step 18

Slide the throttle pushrod into the brass pushrod connector and place the arm onto the servo. With the radio on, move the throttle stick to full throttle. Move the throttle linkage to open the carburetor. Use a 3mm x 6mm machine screw to secure the linkage.



Section 9: Radio Installation

□ Step 19

Use the transmitter to check that the carburetor moves through its full range of motion. If it binds at either low or high throttle, move the linkage toward the center of the servo arm, or away from the center at the throttle arm. If it doesn't make it fully closed or open, move the linkage away from the center of the servo arm, or toward the center of the throttle arm. It may take some time to get things in the right position, but it is well worth it at the field.

□ Step 20

Wrap the receiver and receiver battery in foam to protect them from vibration.

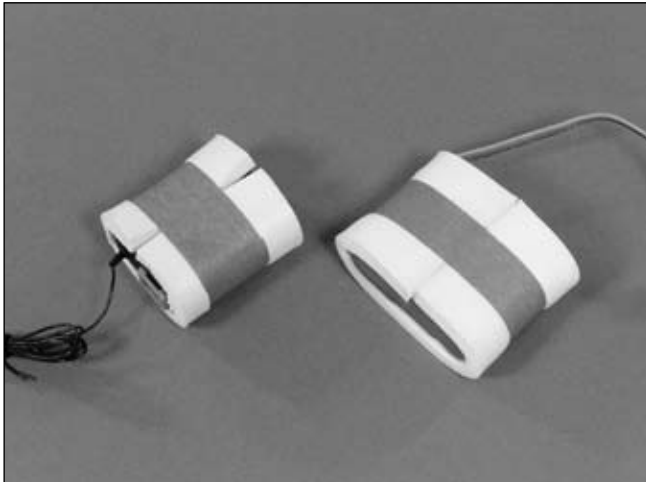

□ Step 21

Place the receiver and receiver battery into the fuselage. Secure their position using straps or by gluing braces inside the fuselage.



□ Step 22

Plug the switch harness into the receiver and receiver battery. Secure the switch in the pre-cut opening in the side of the fuselage. Route the antenna wire from the receiver to the tail of the plane.



Note: Do not cut the antenna wire. Doing so will reduce the range of your particular radio system.

□ Step 23

Secure the pilot to the hatch using Zap-A-Dap-A-Goo.



Section 10: Rigging Installation

Required Parts

- Complete airframe
- Brass adjusters (16)
- 2-56 nut (6)
- Cable crimp (32)
- Brass fitting (equal hole size) (18)
- Brass fitting (unequal hole size) (14)
- 2-56 x 5/8" machine screw (4)
- 2-56 x 3/8" machine screw (2)
- Cable end (right-hand thread) (16)
- Cable end (left-hand thread) (16)

Required Tools and Adhesives

- Hobby knife
- Plies or crimping tool
- Side cutters

The last thing to do is to install the rigging. Although this is one section, it can be classified as two independent rigging procedures: rigging the tail and rigging the wings. You **MUST** install the rigging on the tail or it could possibly fail in flight. The rigging in the wing is not necessary, but adds to the scale realism of your Sopwith.

□ Step 1

Attach the brass fittings to the stabilizer using 2-56 x 5/8" screws and 2-56 nuts. Use the 2-56 x 3/8" machine screws to attach the fittings to the fin. Fittings are placed on both sides of the fin and the top and bottom of the stabilizer. Leave the screws slightly loose so the position of the fitting can be fine-tuned.



Note: There are two types of brass fittings. One has holes that are equal size which are used primarily on the tail. The other fitting has holes of unequal size and is used when rigging the wings.

Hint: Make a slight bend in each of the brass fittings before installing them.

□ Step 2

Install the two brass fittings on the bottom of the fuselage as shown.

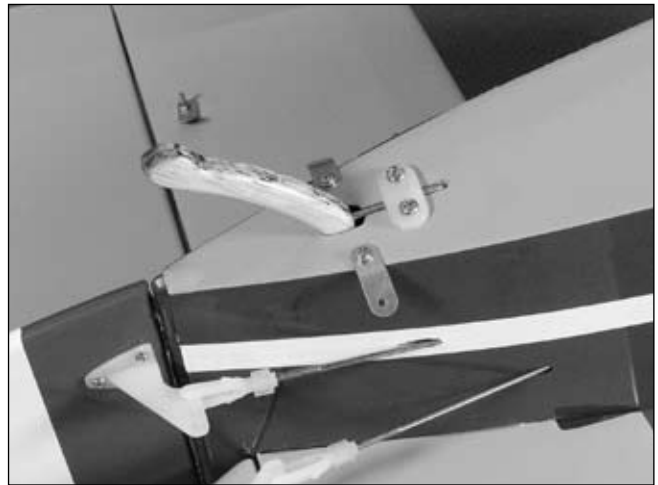

□ Step 3

Slide a clevis retainer onto a clevis. Thread a cable end into the clevis. Prepare four of these connectors.

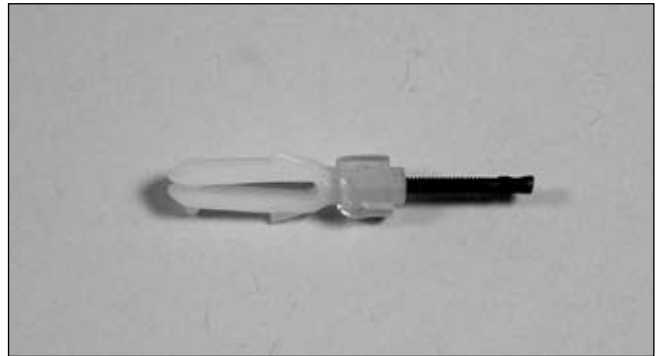

Section 10: Rigging Installation

□ □ Step 4

Cut the cable into four 7" (172mm) pieces. Prepare one cable by sliding the cable through a crimp, through the cable end, then back through the crimp. Pull the excess cable tight and use a crimping tool to complete the job. Repeat for four of the ends.

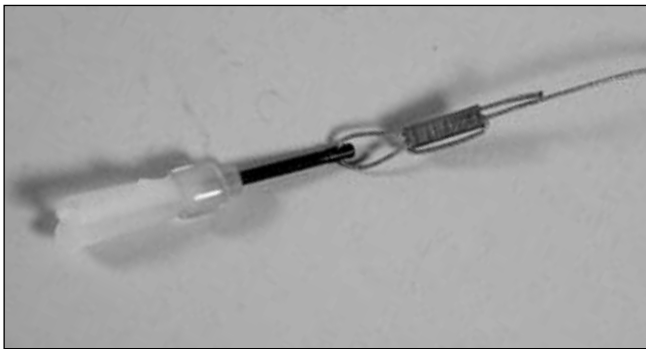
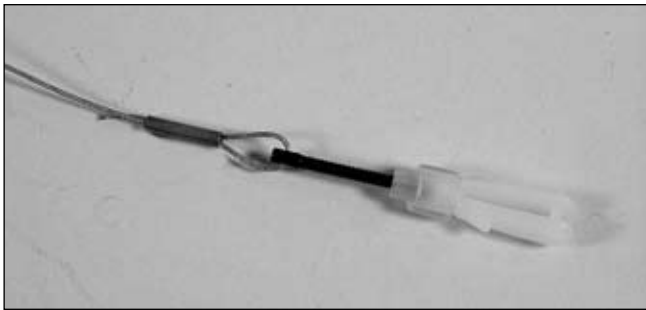
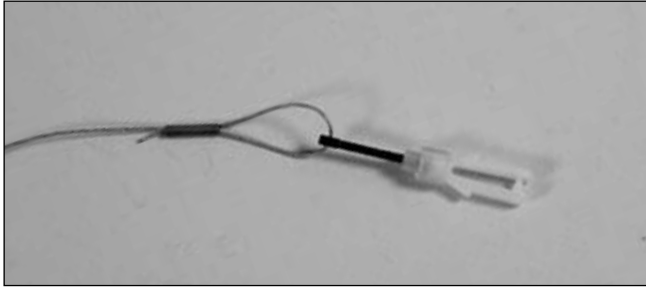

□ □ Step 5

Attach the four connectors to the brass fittings on the top of the stabilizer.

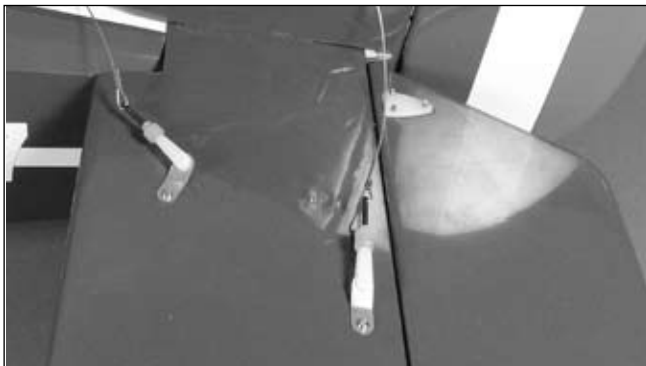

□ □ Step 6

Repeat Step 4, only passing the cable through the brass fittings instead of the cable ends. The cables should have very light tension.



□ Step 7

Repeat Steps 3 through 6 for the cables on the bottom of the stabilizer.

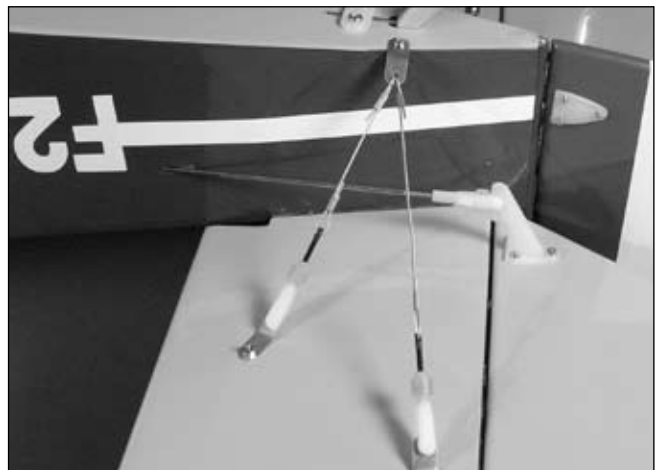

□ Step 8

Locate eight of the brass fittings with unequal size holes. Attach the fittings under the strut fittings as shown.



Section 10: Rigging Installation

□ □ Step 9

Install the wings onto the fuselage. When installing the top wing, place four brass fittings with unequal size holes under the cabane struts.



□ □ Step 10

Install the shorter rigging between the cabane struts and the bottom wing. Leave the tension loose on the cables.



□ □ Step 11

Attach the longer rigging to the rear fitting at the top wing strut. Guide the cable through the hole in the top of the bottom wing and out the hole in the bottom of the bottom wing.

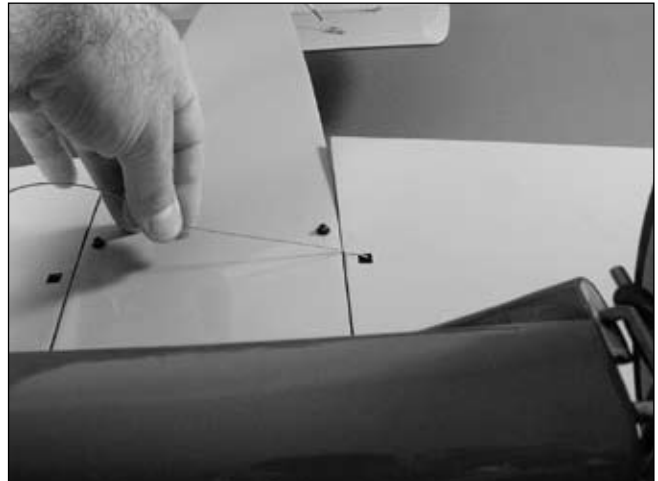

Note: This cable will pass between the cables installed in Step 10.

Section 10: Rigging Installation

Step 12

Attach the brass fitting with equal size holes so the cable will pass through the holes in the top and bottom of the bottom wing. Use a #2 x 3/8" sheet metal screw to secure the fitting to the bottom of the fuselage.

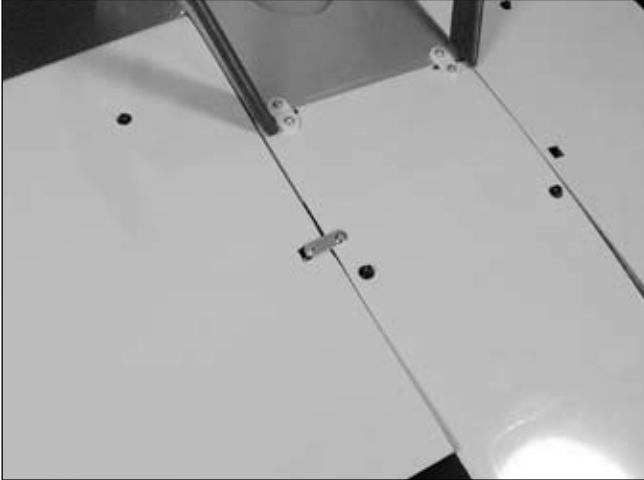

Step 13

Attach a fitting right behind the landing gear. Use a #2 x 3/8" sheet metal screw to secure the fitting.

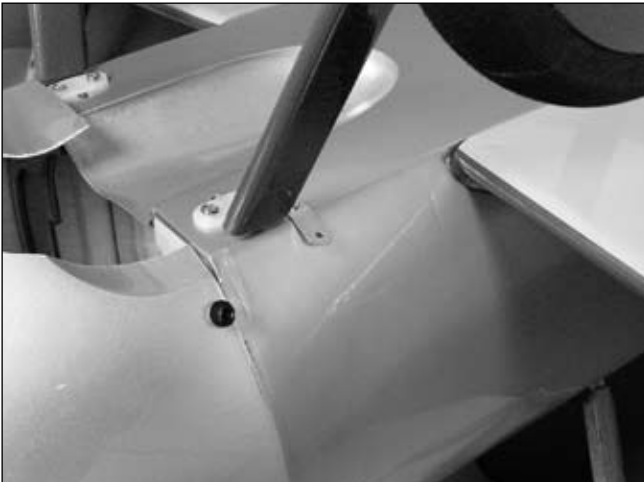

Step 14

Install the longer rigging between the fuselage and the top wing. Again, leave the tension off the rigging at this time.



Step 15

Repeat Steps 9 through 14 for the rigging on the other side of the fuselage.

Step 16

Now you can go back and apply tension to the rigging for the tail and wings. The rigging must have VERY LIGHT tension. Applying too much tension can place unwanted loads on the airframe and even pull the tail or wing out of alignment.

Section 11: Center of Gravity (CG)

Required Parts

- Complete airframe
- Weight box
- 8-32 x 5/8" machine screw (3)
- #8 washer

Required Tools and Adhesives

- Felt-tipped pen
- Phillips screwdriver

An important part of preparing the aircraft for flight is properly balancing the model. This is especially important when various engines are mounted.

Caution: Do not inadvertently skip this step!

Note: Because we felt it is most important to preserve accurate scale lines of the Sopwith Camel, the nose is very short, just like the full-scale airplane. Because of this, nose weight will be needed to balance the model. This is not a problem and the extra weight has been taken into consideration in the design of the model.

□ Step 1

The recommended Center of Gravity (CG) location for the Sopwith Camel is 4" (102mm) behind the leading edge of the top wing near the cabane struts. Use a felt-tipped pen to mark the location of the Center of Gravity on the bottom of the top wing.

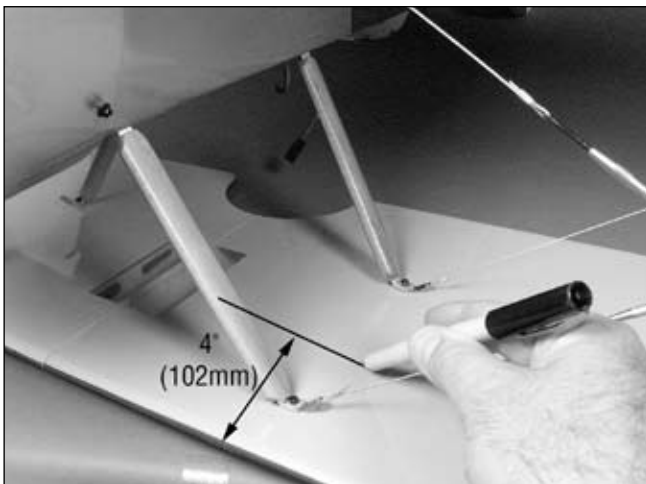

□ Step 2

Install the hatch before checking the Center of Gravity.



□ Step 3

Make sure the aircraft is upright when measuring the CG. Place the airplane on a stand or place your fingers on the marks from the last step and lift the aircraft up. It should rest level or slightly nose down for the correct center of gravity. If necessary, move the battery pack or add weight to either the nose or the tail until the correct balance is achieved. Stick-on weights are available at your local hobby store and work well for this purpose.

□ Step 4

A weight box has been provided in case a large amount of weight is required in the front of the aircraft to achieve the correct center of gravity. The weight box is attached to the front of the aircraft using three 8-32 x 5/8" machine screws and three #8 washers. Use threadlock to prevent the screws from vibrating loose.



Note: Hatch is not shown to allow for detail.

Control Throws

The amount of control throw should be adjusted as closely as possible using mechanical means, rather than making large changes electronically at the radio. By moving the position of the clevis at the control horn toward the outermost hole, you will decrease the amount of control throw of the control surface. Moving it toward the control surface will increase the amount of throw. Moving the pushrod wire at the servo arm will have the opposite effect: Moving it closer to center will decrease throw, and away from center will increase throw. Work with a combination of the two to achieve the closest or exact control throws listed.

Aileron 1" (25mm) up 1" (25mm) down

Note: Aileron throw is measured at the inboard trailing edge of the aileron.

Elevator 1 1/8" (28mm) up 7/8" (22mm) down

Note: Elevator throw is measured at the inboard trailing edge of the elevator.

Rudder 1 1/4" (32mm) right 1 1/4" (32mm) left

Note: Rudder throw is measured at the center of the rudder.

Once the control throws have been set, slide the clevis retainers over each clevis to prevent them from opening during flight.

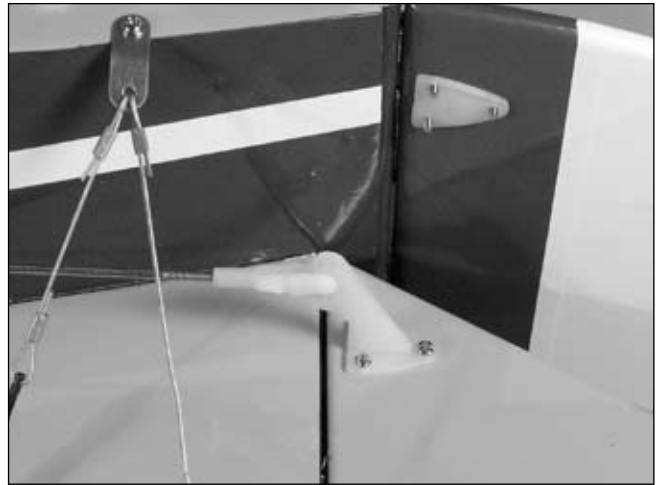

Adjusting the Engine

Step 1

Completely read the instructions included with your engine and follow the recommended break in procedure.

Step 2

At the field, adjust the engine to a slightly rich setting at full throttle and adjust the idle and low-speed needle so that a consistent idle is achieved.

Step 3

Before you fly, be sure that your engine idles reliably, transitions and runs at all throttle settings. Only when this is achieved should any plane be considered ready for flight.

Pre-Flight

Charge both the transmitter and receiver pack for your airplane. Use the recommended charger supplied with your particular radio system, following the instructions provided with the radio. In most cases, the radio should be charged the night before going out flying.

Check the radio installation and make sure all the control surfaces are moving correctly (i.e. the correct direction and with the recommended throws). Test run the engine and make sure it transitions smoothly from idle to full throttle and back. Also ensure the engine is tuned according to the manufacturer's instructions, and it will run consistently and constantly at full throttle when adjusted.

Check all the control horns, servo horns and clevises to make sure they are secure and in good condition. Replace any items that would be considered questionable. Failure of any of these components in flight would mean the loss of your aircraft.

Range Test Your Radio

Range check your radio system before each flying session. This is accomplished by turning on your transmitter with the antenna collapsed. Turn on the radio in your airplane. With your airplane on the ground, you should be able to walk 30 paces away from your airplane and still have complete control of all functions. If not, don't attempt to fly! Have your radio equipment checked out by the manufacturer.

Notes

2006 Official AMA National Model Aircraft Safety Code

GENERAL

- 1) I will not fly my model aircraft in sanctioned events, air shows or model flying demonstrations until it has been proven to be airworthy by having been previously, successfully flight tested.
- 2) I will not fly my model higher than approximately 400 feet within 3 miles of an airport without notifying the airport operator. I will give right-of-way and avoid flying in the proximity of full-scale aircraft. Where necessary, an observer shall be utilized to supervise flying to avoid having models fly in the proximity of full-scale aircraft.
- 3) Where established, I will abide by the safety rules for the flying site I use, and I will not willfully and deliberately fly my models in a careless, reckless and/or dangerous manner.
- 4) The maximum takeoff weight of a model is 55 pounds, except models flown under Experimental Aircraft rules.
- 5) I will not fly my model unless it is identified with my name and address or AMA number, on or in the model. (This does not apply to models while being flown indoors.)
- 6) I will not operate models with metal-bladed propellers or with gaseous boosts, in which gases other than air enter their internal combustion engine(s); nor will I operate models with extremely hazardous fuels such as those containing tetranitromethane or hydrazine.

- 7) I will not operate models with pyrotechnics (any device that explodes, burns, or propels a projectile of any kind) including, but not limited to, rockets, explosive bombs dropped from models, smoke bombs, all explosive gases (such as hydrogen-filled balloons), or ground mounted devices launching a projectile. The only exceptions permitted are rockets flown in accordance with the National Model Rocketry Safety Code or those permanently attached (as per JATO use); also those items authorized for Air Show Team use as defined by AST Advisory Committee (document available from AMA HQ). In any case, models using rocket motors as a primary means of propulsion are limited to a maximum weight of 3.3 pounds and a G series motor. (A model aircraft is defined as an aircraft with or without engine, not able to carry a human being.)
- 8) I will not consume alcoholic beverages prior to, nor during, participation in any model operations.
- 9) Children under 6 years old are only allowed on the flight line as a pilot or while receiving flight instruction.

RADIO CONTROL

- 1) I will have completed a successful radio equipment ground range check before the first flight of a new or repaired model.
- 2) I will not fly my model aircraft in the presence of spectators until I become a qualified flier, unless assisted by an experienced helper.
- 3) At all flying sites a straight or curved line(s) must be established in front of which all flying takes place with the other side for spectators. Only personnel involved with flying the aircraft are allowed at or in the front of the flight line. Intentional flying behind the flight line is prohibited.
- 4) I will operate my model using only radio control frequencies currently allowed by the Federal Communications Commission. (Only properly licensed Amateurs are authorized to operate equipment on Amateur Band frequencies.)

2006 Official AMA National Model Aircraft Safety Code

- 5) Flying sites separated by three miles or more are considered safe from site-to site interference, even when both sites use the same frequencies. Any circumstances under three miles separation require a frequency management arrangement, which may be either an allocation of specific frequencies for each site or testing to determine that freedom from interference exists. Allocation plans or interference test reports shall be signed by the parties involved and provided to AMA Headquarters. Documents of agreement and reports may exist between (1) two or more AMA Chartered Clubs, (2) AMA clubs and individual AMA members not associated with AMA Clubs, or (3) two or more individual AMA members.
- 6) For Combat, distance between combat engagement line and spectator line will be 500 feet per cubic inch of engine displacement. (Example: .40 engine = 200 feet.); electric motors will be based on equivalent combustion engine size. Additional safety requirements will be per the RC Combat section of the current Competition Regulations.
- 7) At air shows or model flying demonstrations, a single straight line must be established, one side of which is for flying, with the other side for spectators.
- 8) With the exception of events flown under AMA Competition rules, after launch, except for pilots or helpers being used, no powered model may be flown closer than 25 feet to any person.
- 9) Under no circumstances may a pilot or other person touch a powered model in flight.

Organized RC Racing Event

- 10) An RC racing event, whether or not an AMA Rule Book event, is one in which model aircraft compete in flight over a prescribed course with the objective of finishing the course faster to determine the winner.
 - A. In every organized racing event in which contestants, callers and officials are on the course:
 1. All officials, callers and contestants must properly wear helmets, which are OSHA, DOT, ANSI, SNELL or NOCSAE approved or comparable standard while on the racecourse.
 2. All officials will be off the course except for the starter and their assistant.
 3. "On the course" is defined to mean any area beyond the pilot/staging area where actual flying takes place.
 - B. I will not fly my model aircraft in any organized racing event which does not comply with paragraph A above or which allows models over 20 pounds unless that competition event is AMA sanctioned.
 - C. Distance from the pylon to the nearest spectator (line) will be in accordance with the current Competition Regulations under the RC Pylon Racing section for the specific event pending two or three pylon course layout.
- 11) RC night flying is limited to low-performance models (less than 100 mph). The models must be equipped with a lighting system that clearly defines the aircraft's position in the air at all times.



© 2006 Horizon Hobby, Inc.
4105 Fieldstone Road
Champaign, Illinois 61822
(877) 504-0233
horizonhobby.com