

HANGAR 9

ShowTime 4D 90

ASSEMBLY MANUAL



Specifications

Wingspan:66 in (1676mm)
Length:68.3 in (1734mm)
Wing Area:900 sq in (58.1sq dm)

Weight:8–9 lb (3.6–4.1 kg)
Radio:4-channel w/6 servos
Recommended Engines:61–1.00 2-stroke
..... .91–1.10 4-stroke

Table of Contents

Covering Colors	2
Contents of Kit	3
Additional Required Equipment.	3
Additional Required Tools and Adhesives.	4
Servo Selection.	4
Before Starting Assembly	5
Warning	5
Using the Manual	5
Warranty Information	5
Section 1 – Hinging the Control Surfaces	6
Section 2 – Aileron Servo Installation	8
Section 3 – Joiner Tube Installation	11
Section 4 –Elevator Servo Installation	13
Section 5 – Landing Gear Installation.	15
Section 6A – Engine Installation: Saito 1.00.	17
Section 6B – Engine Installation: Evolution 1.00	20
Section 7A – Rudder Servo Installation: Pull-pull	23
Section 7B – Rudder Servo Installation: Tail Mounted	26
Section 8 – Tail Wheel Installation	28
Section 9 – Radio Installation.	29
Section 10 – Cowling Installation.	30
Section 11 – Final Assembly	31
Flying Information.	32
Balancing the Model	33
Control Throws.	33
Preflight at the Field	33
2005 Official AMA National Model Aircraft Safety Code.	34

Covering Colors

- White HAUN870
- True Red HANU866
- Bright Yellow HANU872
- Pearl Purple HANU847

Contents of Kit

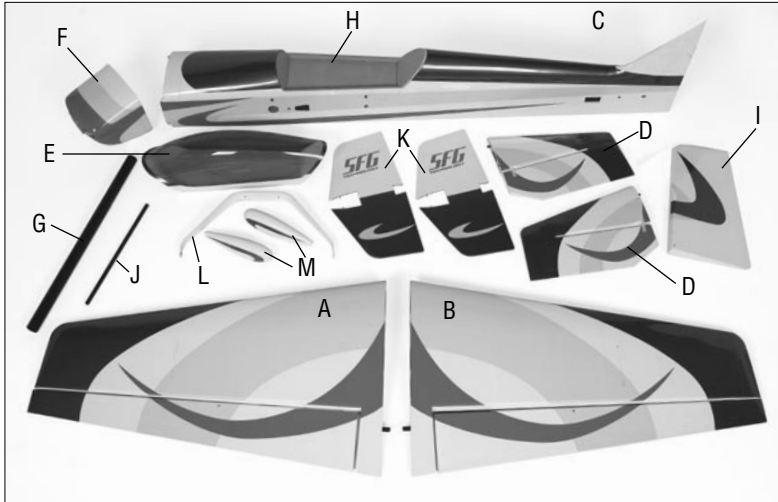

Large Parts:

- | | |
|-------------------------------|-----------|
| A. Right Wing | (HAN2802) |
| B. Left Wing Panel | (HAN2803) |
| C. Fuselage | (HAN2803) |
| D. Stabilizer Set w/Elevators | (HAN2804) |
| E. Canopy | (HAN2806) |
| F. Cowling | (HAN2808) |
| G. Anodized Wing Tube | (HAN2814) |
| H. Canopy Hatch | (HAN2807) |
| I. Rudder | (HAN2805) |
| J. Stabilizer Tube | (HAN2813) |
| K. SFG Set | (HAN2816) |
| L. Carbon Fiber Landing Gear | (HAN2809) |
| M. Wheel Pant Set | (HAN2810) |

Small Parts:

1. Fuel Tank
2. Engine Mount
3. Tail Wheel Assembly (HAN2812)

Items Not Shown:

- Decal Set (HAN2814)
 Pushrod Set (HAN2815)

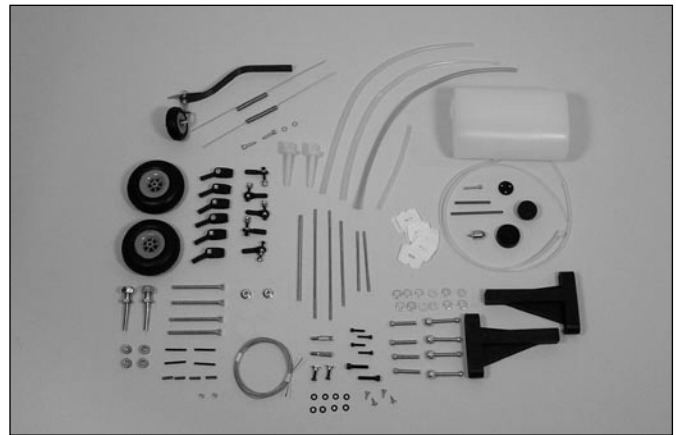

Additional Required Equipment

Radio Equipment

- 6-channel radio system (minimum)
- 1 standard servo for throttle (JRPS537 recommended or equivalent)
- 4 hi-torque servos (JRPS9411 recommended or equivalent)
- 1 hi-torque servo (JRPS8411SA recommended or equivalent for rudder)



Saito™ 1.00 4-stroke
SAIE100



Evolution 1.00
EVOE1000

Recommended JR® Systems

- PCM10X
- XP9303
- XP8103
- X-378
- XP6102
- XF631



JR XP9303

Recommended Engines

- 4-Stroke: Saito 1.00
- 2-Stroke: Evolution 1.00



JR XP6102

Additional Required Tools and Adhesives

Tools

- 4-40 tap
- Adjustable wrench (small)
- Canopy scissors
- Drill (drill press preferred)
- Drill bit: 1/16", 3/16", 5/64", 7/32", #43, 5/32"
- Drum sander
- Cut-off wheel
- Flat blade screwdriver w/short handle
- Foam: 1/4"
- Hex wrench: 3/32"
- Hobby knife
- Masking tape
- Phillips screwdriver (small)
- Razor saw
- Scissors
- Square
- Syringe
- Tap handle
- Toothpicks
- Velcro straps

Adhesives

- 30-minute epoxy
- Medium CA (cyanoacrylate) glue
- CA remover/debonder
- Pacer Z-42 Threadlock
- Pacer hinge glue (PT-55)
- Formula 560—canopy glue
- Shoo Goo

Other Required Items

- Epoxy brushes
- Felt-tipped pen or pencil
- Measuring device (e.g. ruler, tape measure)
- Mixing sticks for epoxy
- Paper towels
- Petroleum jelly
- Rubbing alcohol
- Sanding bar
- Sandpaper (coarse)
- Covering Iron (HAN101)
- Dental floss or string
- Covering Glove (HAN150)
- Sealing Iron Sock (HAN141)

Servo Selection

The servos used for the control surfaces of the ShowTime must have a minimum of 80 ounce inch of servo torque. In the prototype ShowTime, we used JR9411 servos on the ailerons and elevator, and a JR8411SA servo for the rudder.

JR9411 Ultra Precision Wide Bearing (aileron and elevator)

Torque: 82 oz/in	Speed: .15 sec/60°
Weight: 1.36 oz	Size: 0.75" x 1.41" x 1.03"
Motor: Coreless	Ball Bearing: Dual widespaced

JR8411SA Digital Ultra Torque (rudder)

Torque: 155 oz/in	Speed: .18 sec/60°
Weight: 2.00 oz	Size: 0.75" x 1.54" x 1.36"
Motor: Coreless	Ball Bearing: Dual widespaced

Before Starting Assembly

Before beginning the assembly of your ShowTime, remove each part from its bag for inspection. Closely inspect the fuselage, wing panels, rudder, stabilizer and side force generators for damage. If you find any damaged or missing parts, contact the place of purchase.

If you find any wrinkles in the covering, use a heat gun or covering iron to remove them. Use caution while working around areas where the colors overlap to prevent separating the colors.



HAN100 – Heat Gun

HAN150 – Covering Glove



HAN101 – Covering Iron

**HAN141 – Sealing Iron
Sock**

Warning

An RC aircraft is not a toy! If misused, it can cause serious bodily harm and damage to property. Fly only in open areas, preferably at AMA (Academy of Model Aeronautics) approved flying sites, following all instructions included with your radio and engine.

Using the Manual

This manual is divided into sections to help make assembly easier to understand, and to provide breaks between each major section. Remember to take your time and follow the directions.

Warranty Information

Horizon Hobby, Inc. guarantees this kit to be free from defects in both material and workmanship at the date of purchase. This warranty does not cover any component parts damaged by use or modification. In no case shall Horizon Hobby's liability exceed the original cost of the purchased kit. Further, Horizon Hobby reserves the right to change or modify this warranty without notice.

In that Horizon Hobby has no control over the final assembly or material used for the final assembly, no liability shall be assumed nor accepted for any damage resulting from the use of the final assembled product. By the act of using the assembled product, the user accepts all resulting liability.

Please note that once assembly of the model has been started, you must contact Horizon Hobby, Inc. directly regarding any warranty question. Please do not contact your local hobby shop regarding warranty issues, even if that is where you purchased it. This will enable Horizon to better answer your questions and service you in the event that you may need any assistance.

If the buyer is not prepared to accept the liability associated with the use of this product, the buyer is advised to return this kit immediately in new and unused condition to the place of purchase.

Horizon Hobby, Inc.
4105 Fieldstone Road
Champaign, Illinois 61822
(877) 504-0233
horizonhobby.com

Section 1 – Hinging the Control Surfaces

Required Parts

- Wing w/aileron
- Fuselage
- CA hinges (20)
- Stabilizer w/elevators
- Rudder

Required Tools and Adhesives

- Thin CA
- Drill
- T-pins
- Drill bit: 1/16"

□ □ □ Step 1

Carefully remove the tape holding the aileron to the wing. Use a 1/16" drill bit to drill into the wing and aileron at the center of each hinge. This allows the CA to wick farther into the surfaces for better hinge installation.



□ □ □ Step 2

Locate five CA hinges and place a T-pin in the center of the hinge as shown. Slide each of the five hinges into the aileron so the T-pin is resting against the leading edge of the aileron. The slot in the hinge aligns with the hole drilled in Step 1.

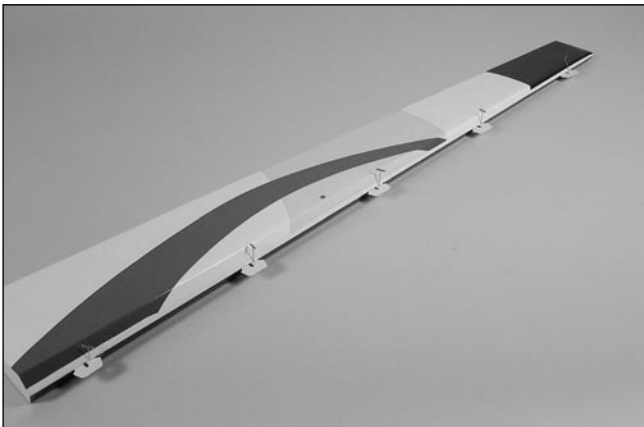

□ □ □ Step 3

Slide the aileron onto the wing until there is only a slight gap between the aileron and wing panel. Remove the T-pins and snug the aileron against the wing panel. Slide the aileron towards the wing tip until the aileron aligns with the wing tip.

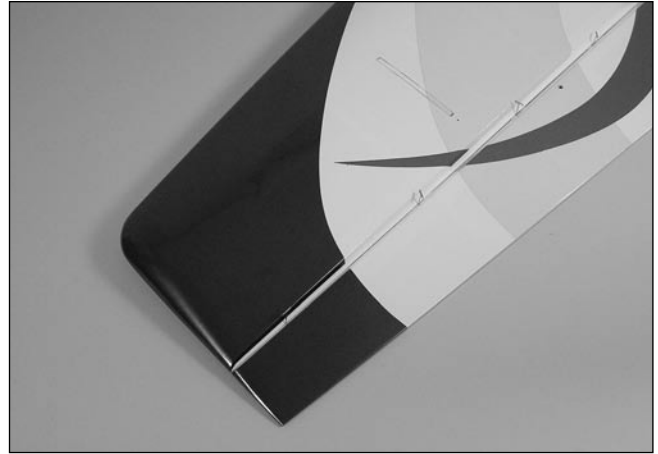

Note: Do not use CA accelerator during the hinging process. The CA must be allowed to soak into the hinge to provide the best bond. Using accelerator will not provide enough time for this process.

□ □ □ Step 4

Deflect the aileron and apply thin CA to the hinge. Apply enough CA to completely saturate the hinge. Use care not to deflect the aileron so it pulls away from the wing. When the hinge is glued in place, there should be no more than a 1/64" hinge gap maintained throughout the length of the aileron.



Section 1 – Hinging the Control Surfaces

Step 5

Turn the wing panel over, deflect the aileron in the opposite direction and apply thin CA to the other side of the hinges as described in the previous step. Make sure the thin CA penetrates completely into both the aileron and wing panel.

Step 6

Use CA remover/debonder and a paper towel to remove any excess CA accumulated on the wing or aileron surface. Allow time for the CA to completely cure before moving to the next step.

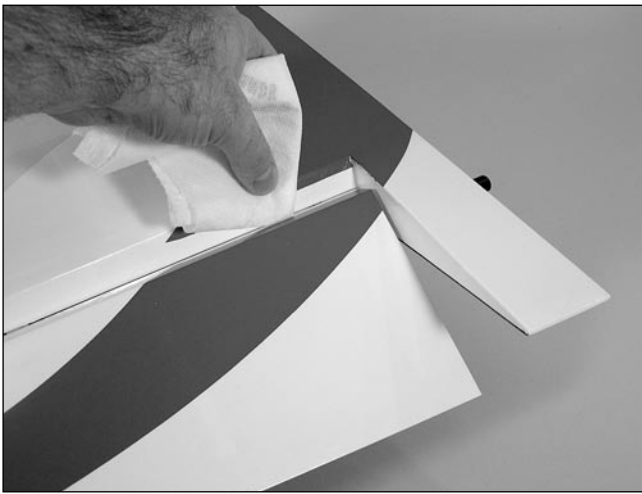

Step 7

Firmly grasp the wing and aileron and gently pull on the aileron to ensure the hinges are secure and cannot be pulled apart. Use caution when gripping the wing and aileron to avoid crushing the structure.

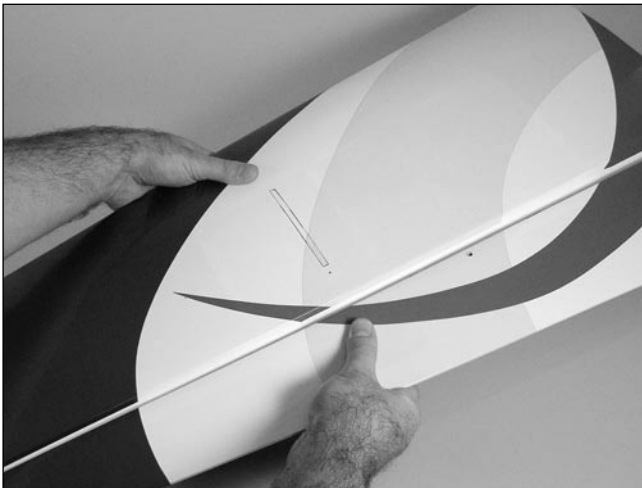

Step 8

Work the aileron up and down several times to work in the hinges and check for proper movement.

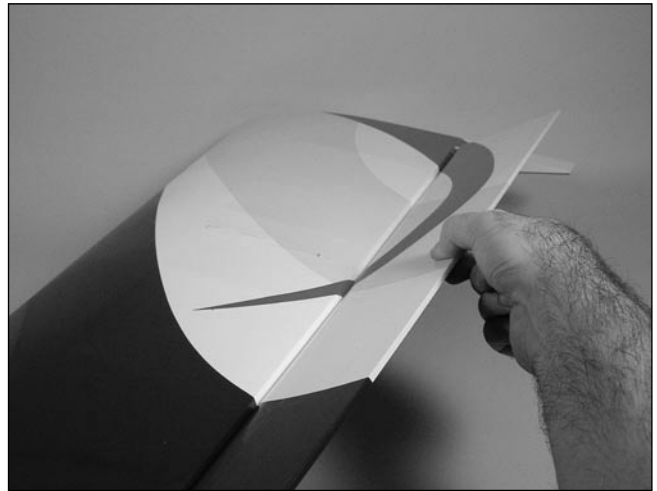
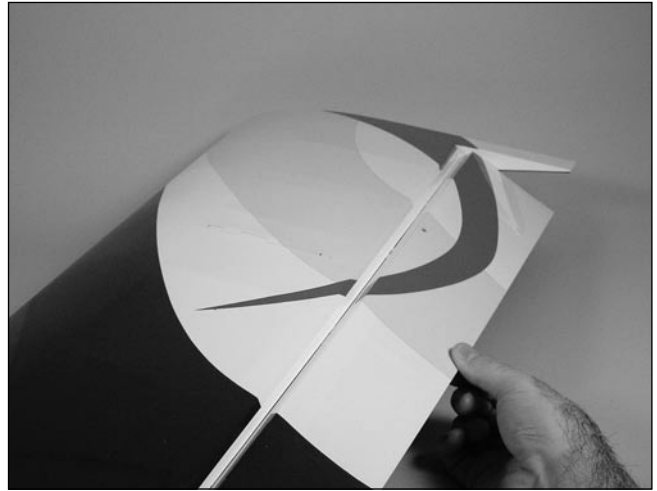

Step 9

Repeat Steps 1 through 8 for the remaining aileron.

Section 1 – Hinging the Control Surfaces

Step 10

Glue the elevator hinges in place using the same techniques used to hinge the ailerons.



Step 11

Since all that's left is the rudder, this is a good time to install the four hinges here as well. Follow Steps 1 through 8 to complete hinging the control surfaces.



Section 2 – Aileron Servo Installation

Required Parts

- Wing panel (right and left)
- 4-40 lock nut (2)
- 2³/₄" aileron linkage (2)
- 8-32 x 2¹/₄" control horn screw (2)
- Ball link for servo arm (2)
- Molded swivel link (2)
- Ball link for swivel link (2)
- 4-40 x 1/2" socket head screw (2)

Required Tools and Adhesives

- Phillips screwdriver (small)
- Ruler
- Drill
- Drill bit: 1/16"
- 6-minute epoxy
- Threadlock
- 12" Servo Extension (JRPA098) (2)
- HD 1/2 Servo Arm 4-40: JR (HAN3574) (2)

Step 1

Install the servo hardware (grommets and eyelets) included with the servo.



Section 2 – Aileron Servo Installation

□ □ Step 2

Plug a 12" servo extension onto the servo. Either tie the servo leads together, using a commercially available connector, or use unwaxed dental floss to secure the extensions to prevent them from coming loose during flight.

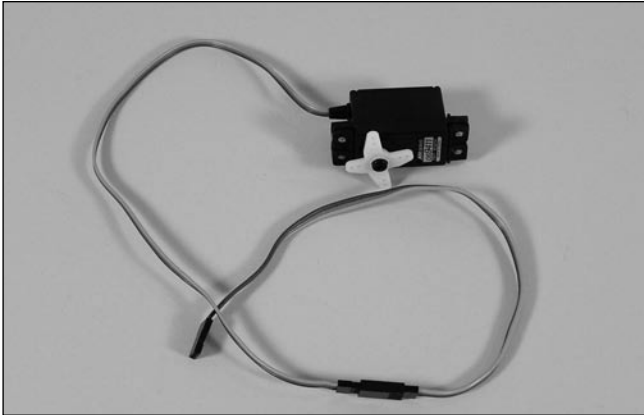

□ □ Step 3

Tie a weight to a piece of string. A wheel collar works great in this application. Lower the string into the wing from the aileron servo opening. Hold the wing with the tip upwards and let the weight drop out through the wing root for the servo.

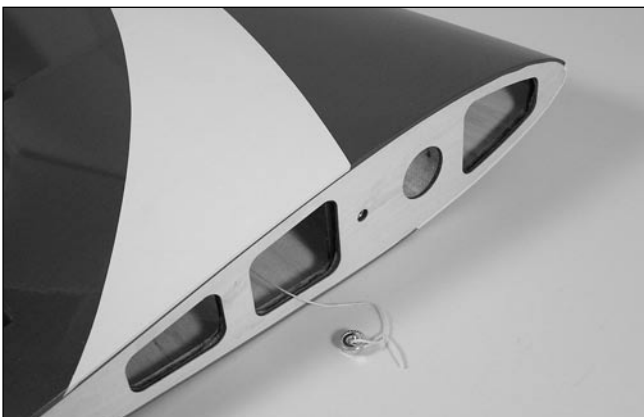
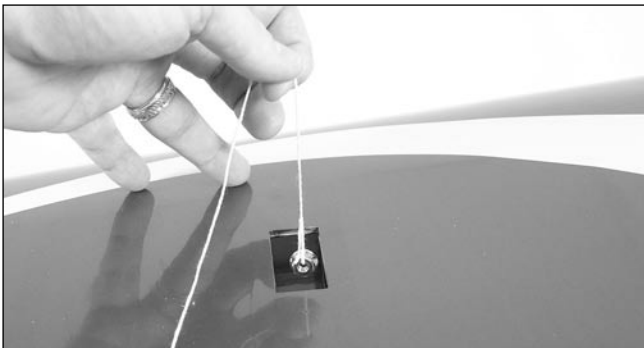

□ □ Step 4

Tie the string to the servo extension and insert the servo into the wing. Use the string to pull the servo lead through the wing. Position the servo so the output shaft is towards the trailing edge of the wing. Use a 1/16" drill bit to drill the locations for the servo screws. Mount the servos using the hardware provided with the servos.



□ □ Step 5

Mix a small amount of 6-minute epoxy and lightly coat the inside of the hole in the aileron and the 8-32 x 2 1/4" control horn screw. Slide the screw into the hole from the top of the wing. Wipe away any excess epoxy on the wing and screw with rubbing alcohol and a paper towel. Allow the epoxy to fully cure before continuing.

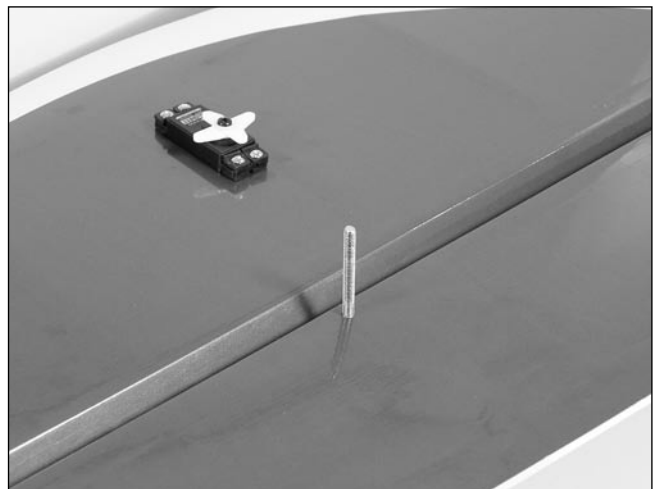

Section 2 – Aileron Servo Installation

Step 6

Screw the molded swivel link onto the 8-32 screw until the distance from the aileron surface to the top of the link is $27/32$ ".

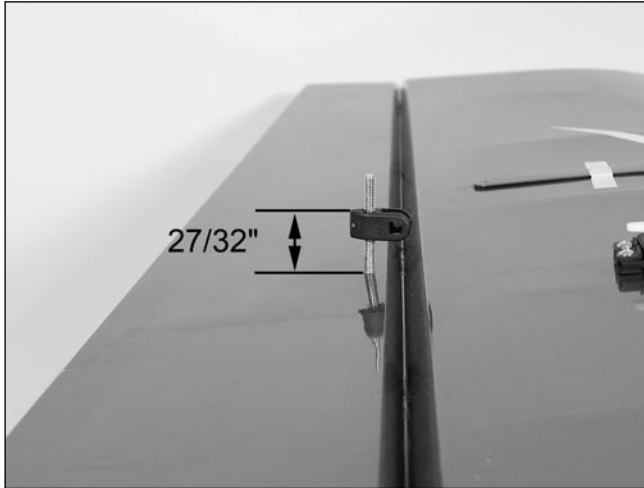

Step 7

Using the 4-40 screw (don't substitute a standard screw) and nut included, attach the ball link to the outer hole in the servo arm from the bottom side as shown. The sequence is screw, ball link, servo arm, and nut.

Note: Hangar 9® aluminum servo arms are suggested for ease of installation and durability. Use HD 1/2 Servo Arm 4-40: JR (HAN3574) for the aileron servos.



Step 8

Screw a 4-40 ball link 5 to 6 turns onto each end of a $2\frac{3}{4}$ " long aileron linkage. Adjust the linkage length until the hole in the ball link aligns with the outer hole in the servo arm when the aileron is neutral and the servo arm is centered.

Step 9

Center the servo using the radio system. Attach the servo horn to the servo using the screw provided with the servo.

Step 10

Attach the linkage to the servo horn on the aileron. Adjust the link so the aileron is centered at the same time as the servo. Use threadlock to secure the screw.

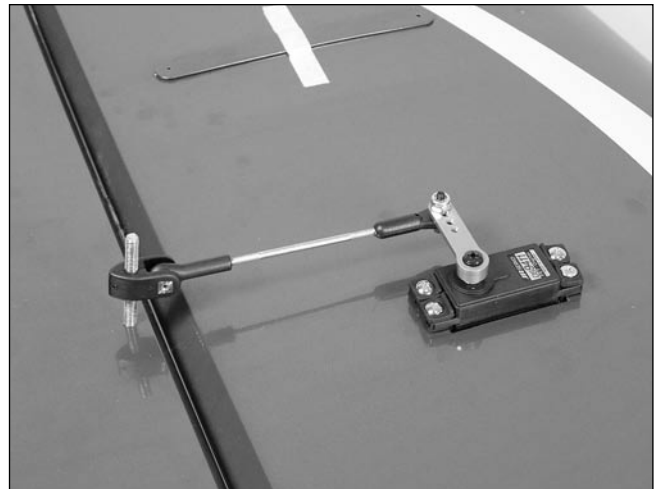

Step 11

Repeat Steps 1 through 10 for the remaining wing panel.

Section 3 – Joiner Tube Installation

Required Parts

- Wing panels
- Wing tube
- 1/4-20 x 2" nylon bolt (2)
- 4-40 x 1/2" socket head screw (2)
- Fuselage
- Stabilizer tube

Required Tools and Adhesives

- Drill
- Tap handle
- Ruler
- Drill bit: #43
- 4-40 tap

Step 1

Remove the four 4-40 x 1/2" screws securing the hatch to the fuselage. Remove the hatch and store it in a safe place until later.

Step 2

Locate the wing tube and carefully slide it into one wing panel. Slide the wing (with tube) into the wing tube opening in the fuselage. Make sure the wing panel alignment pins slide into the holes provided in the fuselage. Be sure the alignment pins are secure in the wing halves before installing the wings. If they are not, remove the pin and apply a small amount of thin CA into the tube socket and reinstall the alignment pin.



Step 3

Carefully slide the remaining wing panel onto the wing tube that projects from the fuselage. The fit may be tight; use caution when inserting the wing panels onto the wing tube and fuselage.

Step 4

Secure the wing panels using the 1/4-20 x 2" nylon wing bolts.



Step 5

Insert the stabilizer tube into the aft hole in the fuselage. Measure the distance of the exposed tube and adjust until both sides are equal.

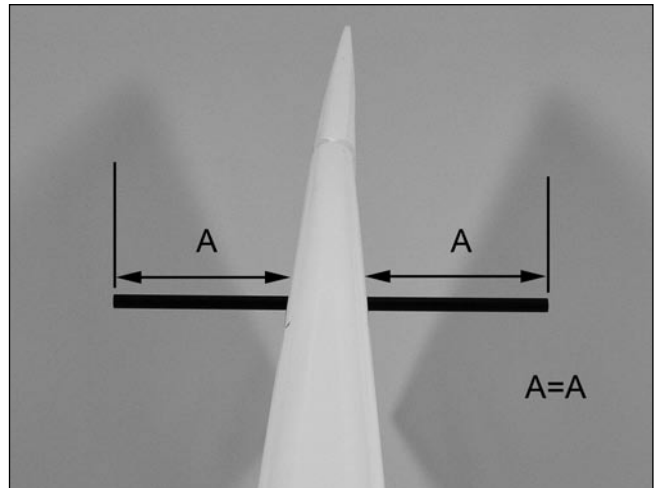

Section 3 – Joiner Tube Installation

□ Step 6

Mark the tube on both sides of the fuselage using a felt-tipped pen.



□ Step 7

Remove the tube and install it into one elevator up to the first line on the tube. Drill through the hole into the stabilizer. Do not drill through the opposite side of the stabilizer tube. Tap the hole for a 4-40 bolt. Install a 4-40 x 1/2" bolt to secure the tube in the stabilizer.

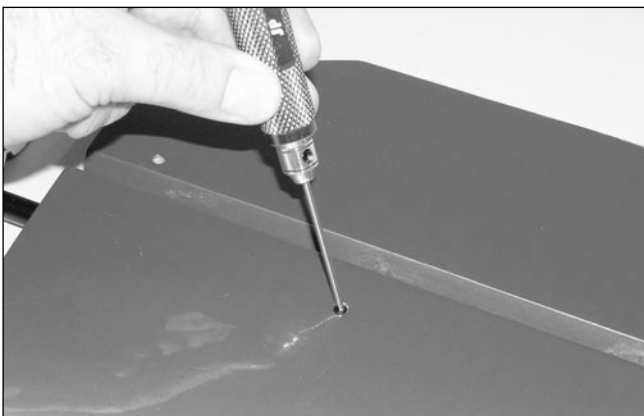
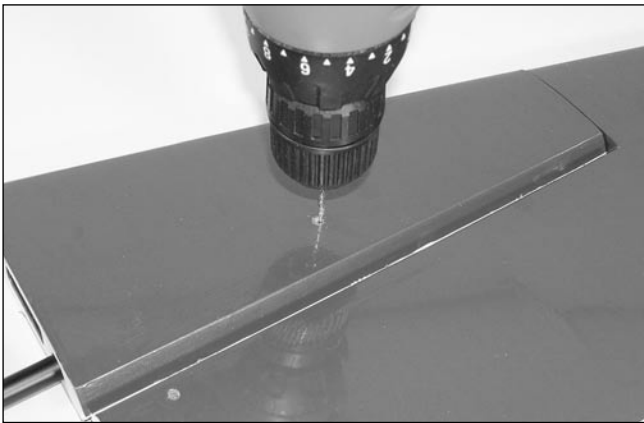

□ Step 8

Slide the assembly into the fuselage. Slide the remaining stab half onto the tube and drill and tap the location for the 4-40 retaining bolt. Install the bolt to complete the procedure.

Hint: When removing the stabilizer for storage, remove only one bolt, leaving the tube secured in the remaining stabilizer. Trying to install the tube without the aid of an alignment guide can be frustrating.



Section 4 –Elevator Servo Installation

Required Parts

- Fuselage w/ stabilizer
- 5" elevator linkage (2)
- 4-40 locknut (2)
- 8-32 flange nut (2)
- Molded swivel link (2)
- Ball link for swivel link (2)
- 4-40 tapered standoff (2)
- Ball link for servo arm (2)
- 4-40 x 1/2" socket head screw (2)
- 8-32 x 2 1/4" control horn screw (2)

Required Tools and Adhesives

- Drill
- Drill bit: 1/16"
- Dental floss or string
- 6-minute epoxy
- Control horn ball ends (2)
- 24" Servo Extensions (JRPA102) (2)
- Hangar 9 3D XL 1/2 Servo Arm 4-40:JR (HAN3578)

Note: Using two standard rotation servos and a standard Y-harness for the elevators will result in them moving in opposite directions instead of the same direction. As such, the elevator installation will either require the use of a one reversed rotation servo and one standard rotation servo or a reversing Y-harness. It is highly recommended to use a computer radio or a JR® MatchBox™ to link the two elevator servos to operate properly.

The elevators require a minimum of 80 ounce inch of servo torque. In the prototype ShowTime we used JR9411 servos with excellent results. Using servos with less torque could cause a crash.

Step 1

Install a 24" servo extension onto an elevator servo. Tie the servo leads together, use a commercially available connector, or use unwaxed dental floss to secure the extensions to prevent them from coming loose during flight. Install one side only of the two Y-harnesses to two of the servos, also tying knots to prevent disconnection. The other servo will be hooked up to the Y-harness when installed in the airplane. One elevator servo will need to be a reversed-direction servo.

Step 2

Install the servo in the fuselage tail section with the output shaft to the rear as shown in the photo.

Step 3

Using the screws included with the servos, fasten the servos in place. You may find it helpful to drill a 1/16" pilot hole before installing the screws.

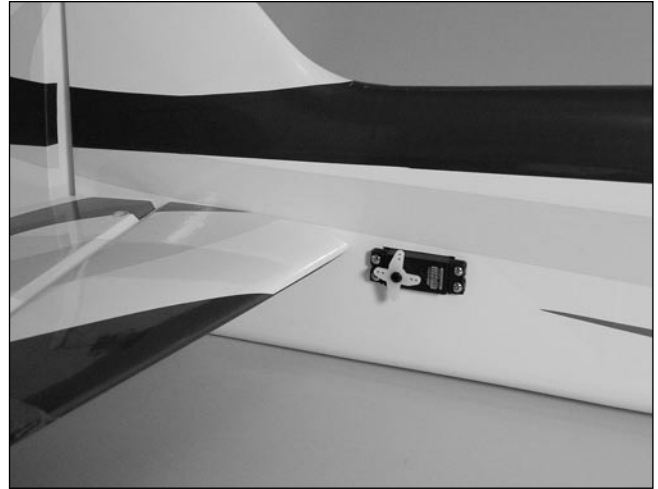

Step 4

Mix a small amount of 6-minute epoxy and lightly coat the inside of the hole in the elevator and the 8-32 x 2 1/4" control horn screw. Slide the screw into the hole from the top of the elevator. Wipe away any excess epoxy on the wing and screw with rubbing alcohol and a paper towel. Allow the epoxy to fully cure before proceeding to the next step.

Section 4 –Elevator Servo Installation

Step 5

Screw the molded swivel link onto the 8-32 screw until the distance from the elevator surface to the top of the link is $31/32$ ".

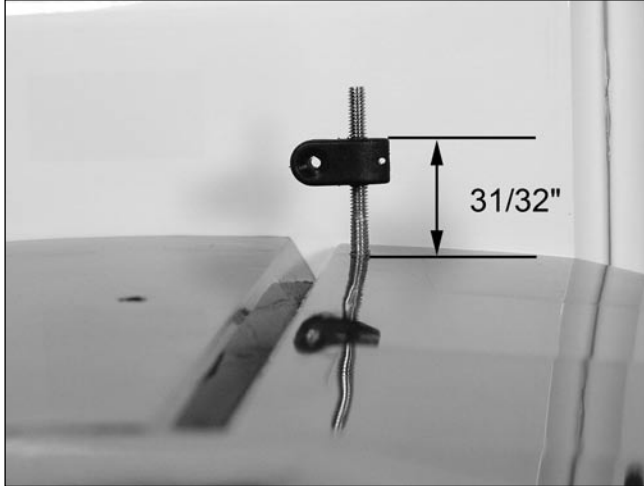

Step 6

Remove the stock servo arms from the elevator servos and replace them with Hangar 9 3D XL 1/2 Servo Arm 4-40: JR. The arms need to face down as shown. Be sure to use a drop of threadlock on the servo arm screw if using metal-gearred servos.

Step 7

Screw a 4-40 ball link 5 to 6 turns onto a 5" elevator linkage. Screw the opposite end of the linkage into the swivel control horn on the elevator. Adjust the linkage length until the hole in the ball link lines up with the outer hole in the servo arm when the elevator is neutral and the servo arm is centered.

Step 8

Use the included 4-40 screws and nuts to attach the ball link to the outer hole in the arm. The correct sequence is 4-40 screw, ball link, servo arm, and 4-40 locknut. Be sure to use threadlock.

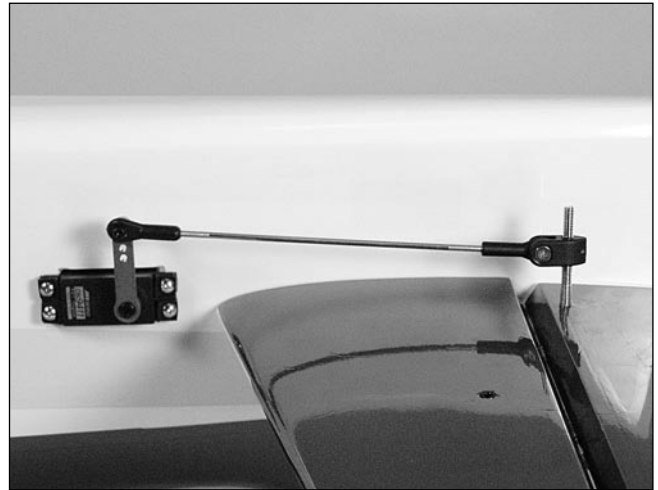

Step 9

Repeat Steps 1 through 8 for the remaining elevator servo and linkage.

Section 5 – Landing Gear Installation

Required Parts

- Fuselage
- Main gear axle w/nut (2)
- 2 1/2" wheel (2)
- Wheel pant (left and right)
- 8-32 x 3/4" socket head bolt (2)
- 4-40 x 1/2" socket head screw (2)
- #8 washer (2)
- #4 washer (2)
- 3/16" wheel collar (4)

Required Tools and Adhesives

- Felt-tipped pen
- Adjustable wrench (small)
- Hex wrench: 5/32", 9/64"
- Ruler

Step 1

Install the axles in the landing gear. Secure the axles using an adjustable wrench and the nuts provided with the axles.



Step 2

Install the landing gear using two 8-32 x 3/4" socket head bolts and two #8 washers.



Step 3

Fit the pants over the axle on the landing gear. Align the centerline of the wheel pant to the centerline of the fuselage. Use a felt-tipped pen to transfer the location of the mounting hole from the landing gear onto the wheel pant.

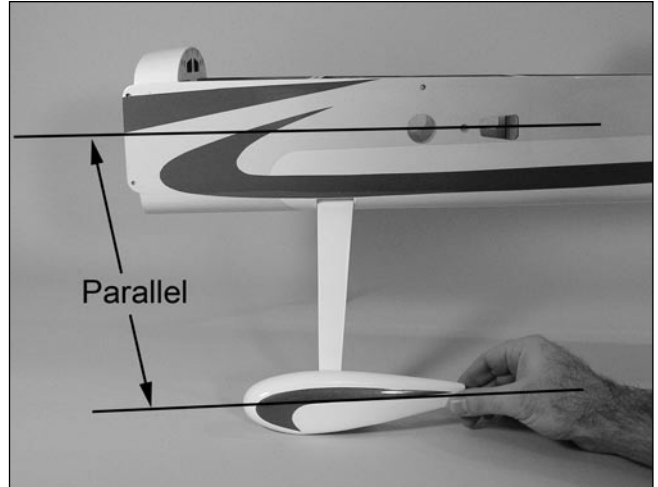

Section 5 – Landing Gear Installation

Step 4

Remove the pant and use a 9/64" drill bit to drill the location marked in the previous step.

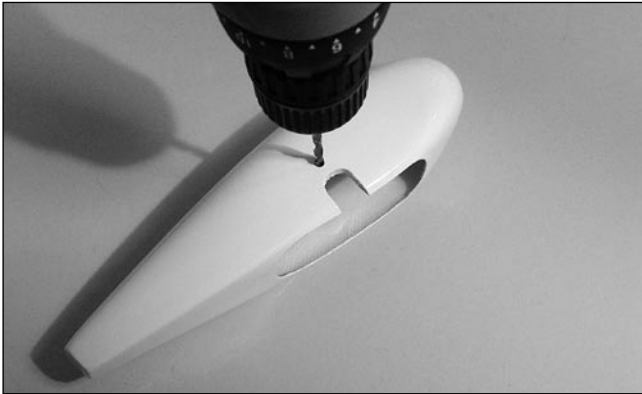

Step 5

Install a 4-40 blind nut into the hole from the inside of the pant. The nut will be drawn into the plywood later in this section.



Step 6

Install the following items onto the axle: 3/16" wheel collar, wheel, 3/16" wheel collar.



Step 7

Secure the pant in place using a 4-40 x 1/2" socket head screw and a #4 washer. **Use threadlock on the screw to prevent it from coming loose in flight.**



Step 8

Center the wheel in the wheel pant and tighten the collars to prevent the wheel from moving side to side. Use threadlock on both set screws.



Step 9

Repeat Steps 3 through 8 for the remaining wheel pant.

Section 6A – Engine Installation: Saito 1.00

Required Parts

- Fuselage
- 8-32 x 1" screw (4)
- #8 washer (12)
- 8-32 x 1 1/4" screw (4)
- Nylon clevis
- 17" throttle pushrod tube
- Engine mount (2)
- 8-32 locknut (4)
- Fuel tank assembly
- 13" tie wrap (2)
- 1/4" fuel tubing

Required Tools and Adhesives

- Medium CA
- Drill
- Square
- Foam: 1/4"
- Threadlock
- Ruler
- Drill bit: 11/64"
- Hobby knife
- Felt-tipped pen

Step 1

Locate the two engine mount halves. Attach them to the firewall using four 8-32 x 1" screws and four #8 washers.

Use threadlock on the screw to prevent it from coming loose in flight.

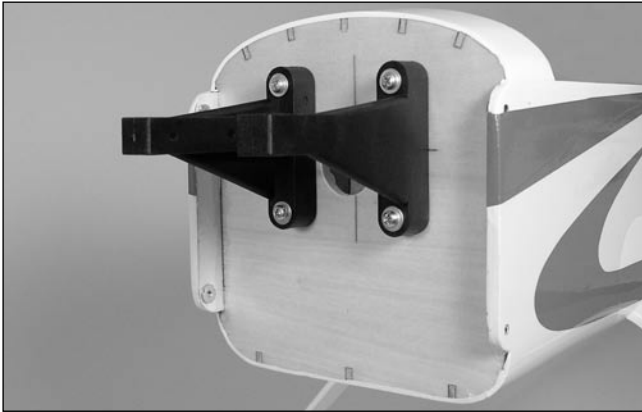

Step 2

Place the engine onto the engine mount. Position the engine so the drive washer is 5 3/4" from the firewall.

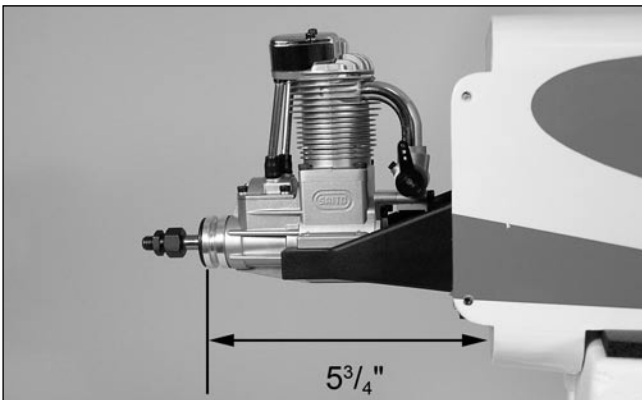

Step 3

Transfer the location of the holes on the engine mounting lugs onto the engine mount.



Step 4

Use a drill and 11/64" drill bit to drill the locations for the engine mounting bolts.

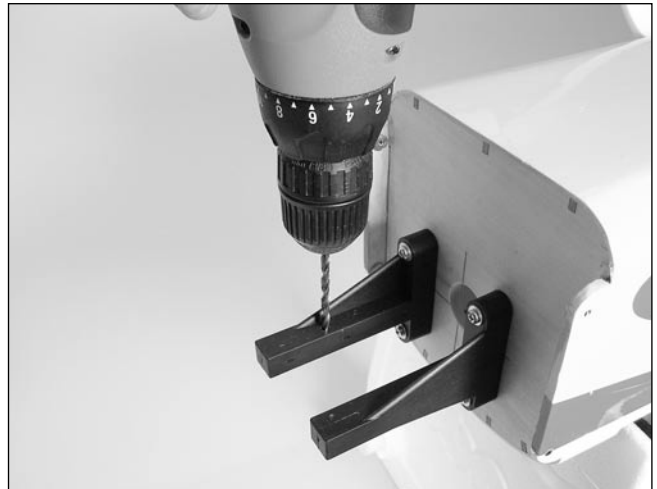

Note: It is best to use a drill press for drilling the holes in the engine mounts.

Section 6A – Engine Installation: Saito 1.00

□ Step 5

Attach the engine to the mount using four 8-32 x 1 1/4" bolts, eight #8 washers and four 8-32 locknuts.

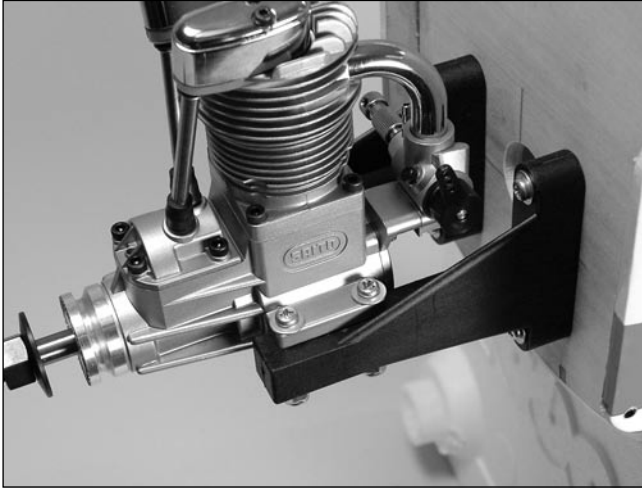

□ Step 6

Mark the location for the throttle pushrod onto the firewall using a felt-tipped pen. Drill the location using an 11/64" drill bit.

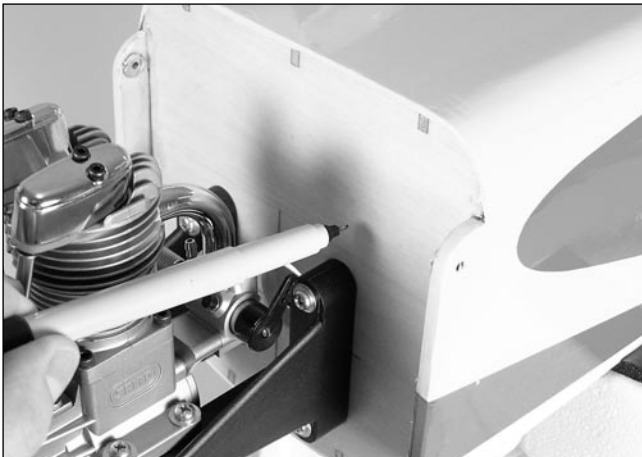

□ Step 7

Roughen the end of the pushrod tube using coarse sandpaper. Slide the tube into the hole, guiding it to the sides of the fuel tank area. The tube will extend 1/16" forward of the firewall. Use medium CA to glue the tube into position.

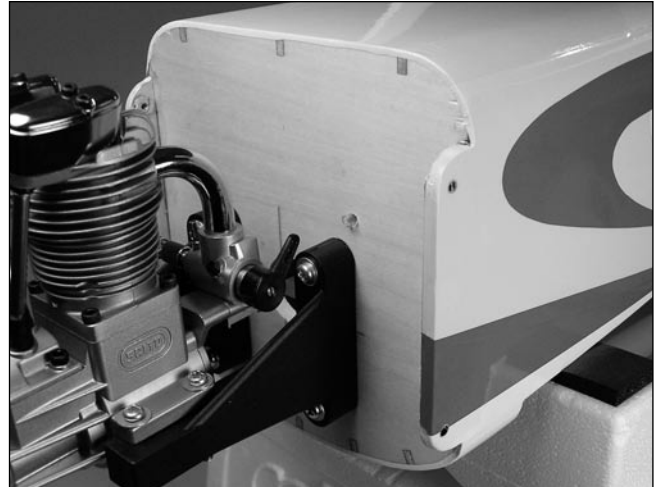

□ Step 8

Trim the pushrod tube at the front edge of the servo tray.

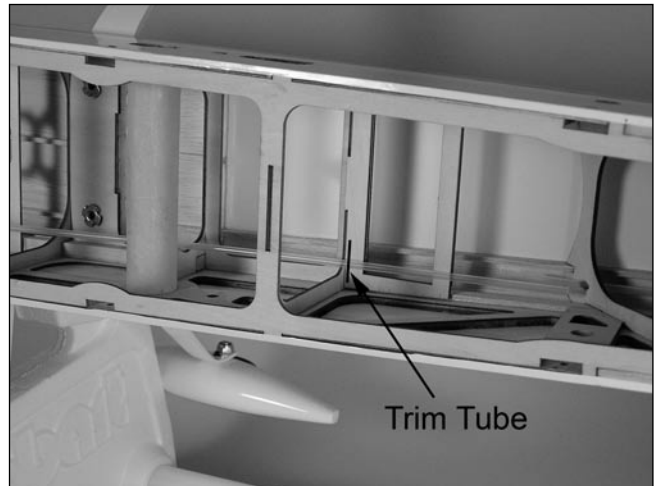

Section 6A – Engine Installation: Saito 1.00

Step 9

Slide the clevis retainer onto the clevis, and then thread the clevis onto the throttle pushrod. Slide the pushrod into the tube, and attach the clevis to the throttle arm.



Step 10

Position the tank into the fuselage. Install the fuel tank brace at the rear of the tank. Use the 13" tie wraps to secure the fuel tank to the tank floor.

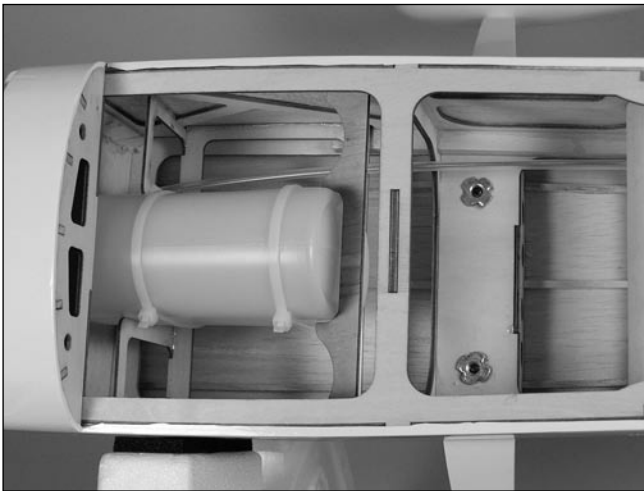

Note: Before installing the fuel tank, look at the tubes of the tank to determine which is the vent and which is the clunk line.

Step 11

Connect two 12" pieces of fuel tubing for pickup and vent tubes. Attach the green tubing to the pick-up, the red to the vent.

Step 12

Make the proper connections to the engine, using the engine manufacturer's instructions. If you are using a 4-stroke, make sure to route the crankcase vent to the outside of the cowling.



Note: Connect the pressure line to the muffler once the cowl has been trimmed and fitted.

Section 6B – Engine Installation: Evolution 1.00

Required Parts

- Fuselage
- 8-32 x 1" screw (4)
- 17" throttle pushrod tube
- 8-32 x 1 1/4" screw (4)
- Nylon clevis
- Fuel Tank Assembly
- Engine mount (2)
- 8-32 locknut (4)
- #8 washer (12)
- 13" tie wrap (2)
- 1/4" fuel tubing

Required Tools and Adhesives

- Medium CA
- Drill bit: 11/64"
- Square
- Foam: 1/4"
- Drill
- Ruler
- Hobby knife
- Felt-tipped pen

Step 1

Locate the two engine mount halves. Attach them to the firewall using four 8-32 x 1" screws and four #8 washers.

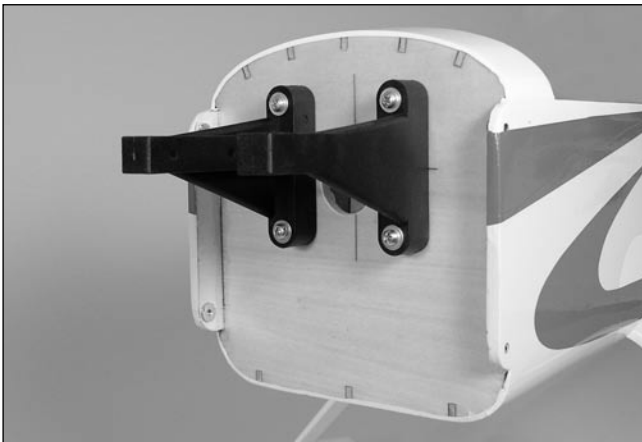

Step 2

Place the engine onto the engine mount. Position the engine so the drive washer is 5 3/4" from the firewall.

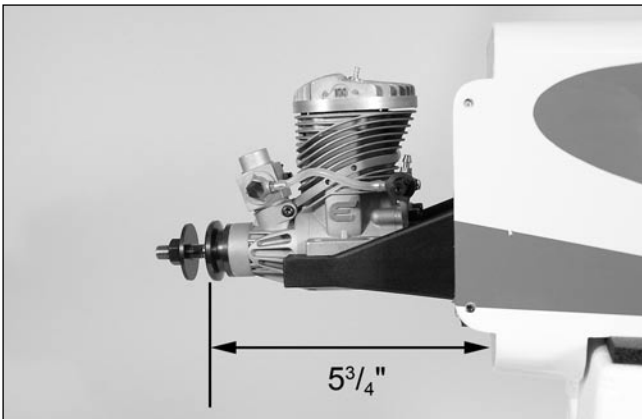

Step 3

Transfer the location of the holes on the engine mounting lugs onto the engine mount.

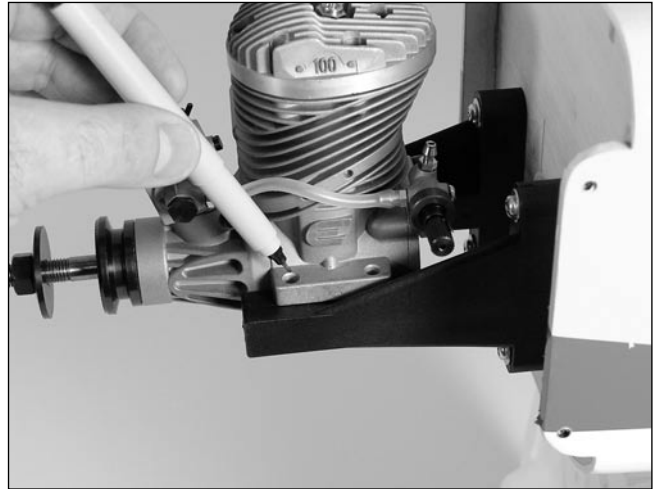

Step 4

Use a drill and 11/64" drill bit to drill the locations for the engine mounting bolts.

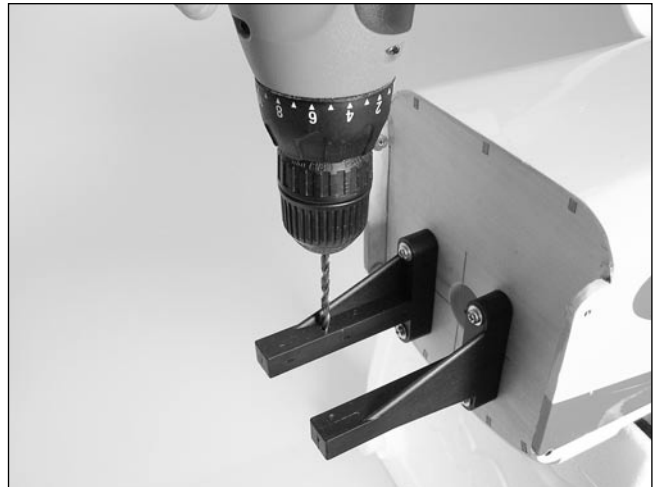

Note: It is best to use a drill press for drilling the holes in the engine mounts.

Section 6B – Engine Installation: Evolution 1.00

Step 5

Attach the engine to the mount using four 8-32 x 1 1/4" bolts, eight #8 washers and four 8-32 locknuts.

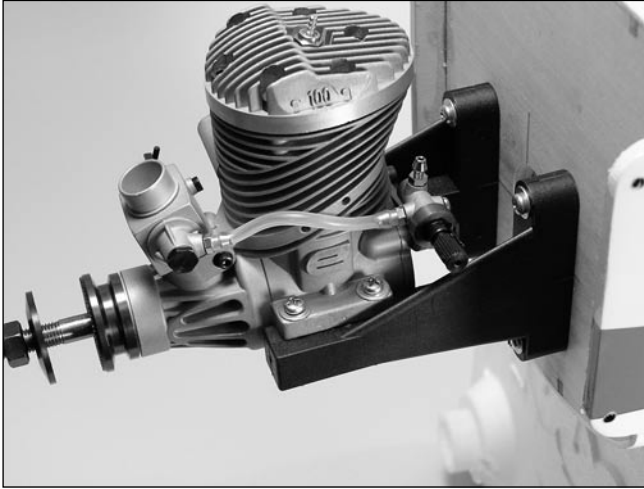

Step 6

Mark the location for the throttle pushrod onto the firewall using a felt-tipped pen. Drill the location using an 11/64" drill bit.



Step 7

Roughen the end of the pushrod tube using coarse sandpaper. Slide the tube into the hole, guiding it to the sides of the fuel tank area. The tube will extend 1/16" forward of the firewall. Use medium CA to glue the tube into position.



Step 8

Trim the pushrod tube at the front edge of the servo tray.

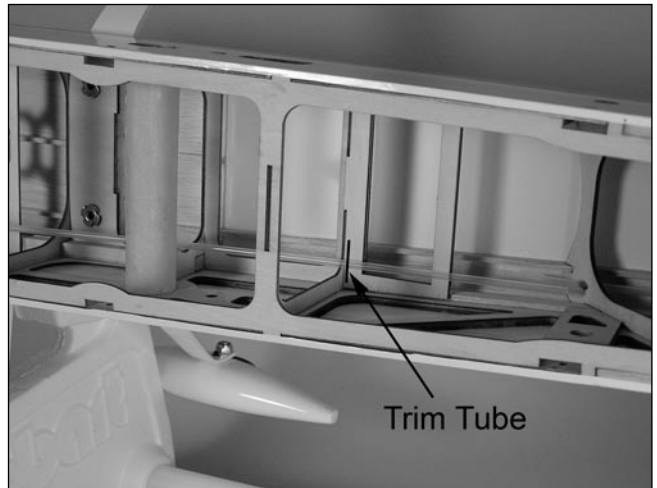

Section 6B – Engine Installation: Evolution 1.00

Step 9

Slide the clevis retainer onto the clevis, and then thread the clevis onto the throttle pushrod. Slide the pushrod into the tube, and attach the clevis to the throttle arm.

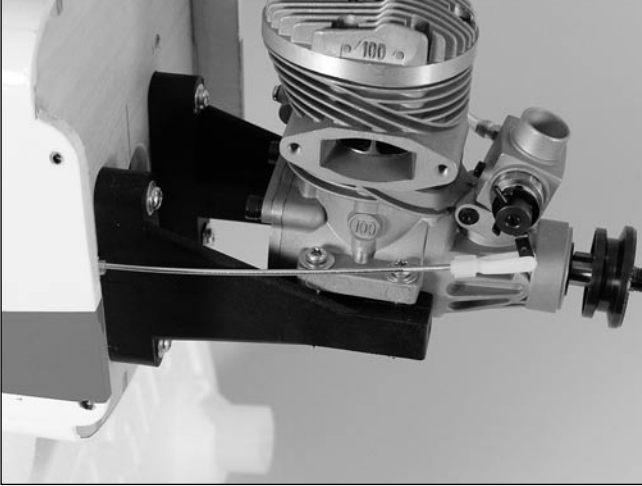

Step 10

Position the tank into the fuselage. Install the fuel tank brace at the rear of the tank. Use the 13" tie wraps to secure the fuel tank to the tank floor.

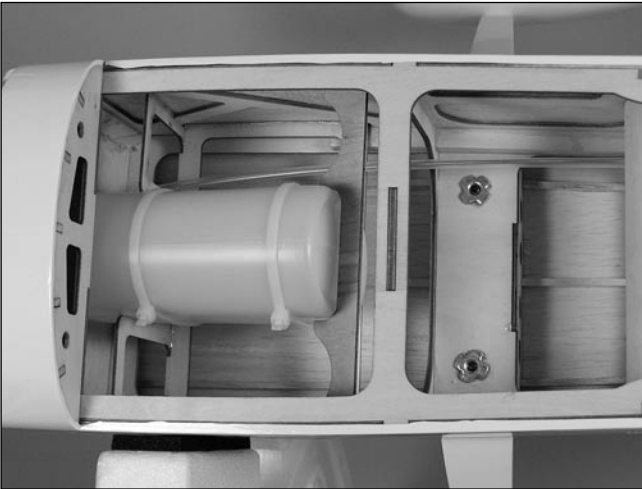

Note: Before installing the fuel tank, look at the tubes of the tank to determine which is the vent and which is the clunk line.

Step 11

Connect two 12" pieces of fuel tubing for pickup and vent tubes. Attach the green tubing to the pickup, the red to the vent.

Step 12

Make the proper connections to the engine, using the engine manufacturer's instructions.

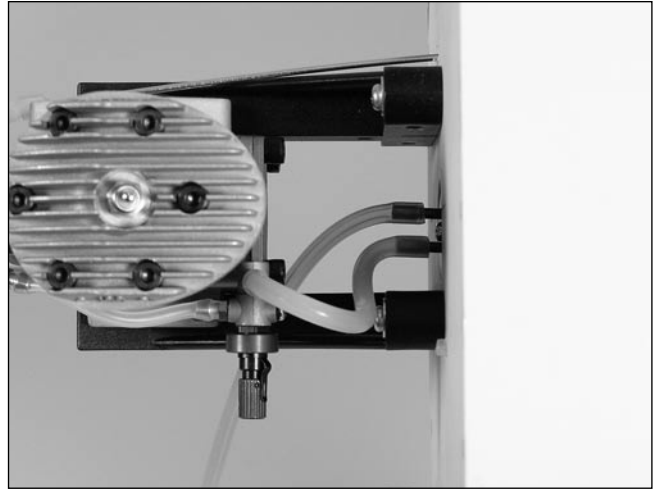

Note: Connect the pressure line to the muffler once the cowl has been trimmed and fitted.

Section 7A – Rudder Servo Installation: Pull-pull

Required Parts

- Fuselage assembly
- 8-32 flange nut (2)
- Molded swivel link (2)
- Threaded cable end (4)
- 8-32 x 4" control horn screw
- 4-40 x 1/2" socket head screw (2)
- Cable
- 4-40 locknut (2)
- 4-40 ball link (2)

Required Tools and Adhesives

- Threadlock
- Hangar 9 3D XL Full Servo Arm 4-40:JR (HAN3576)
- Ruler

The rudder requires a minimum of 120 ounce inch of servo torque. In the prototype ShowTime we used JR8411SA servos with excellent results. Using servos with less torque could result in blowback.

The ShowTime has two options for mounting the rudder servo. For lighter engines a pull-pull system is used. For heavier engines a tail-mounted servo is used. Use the appropriate servo location based on your engine selection.

Step 1

Slide the 8-32 x 4" control horn screw into the hole in the rudder. Thread the 8-32 flange nuts onto the screw from both sides of the rudder. Position the screw so it is centered in the rudder. Use threadlock on the nuts to prevent them from loosening during flight.

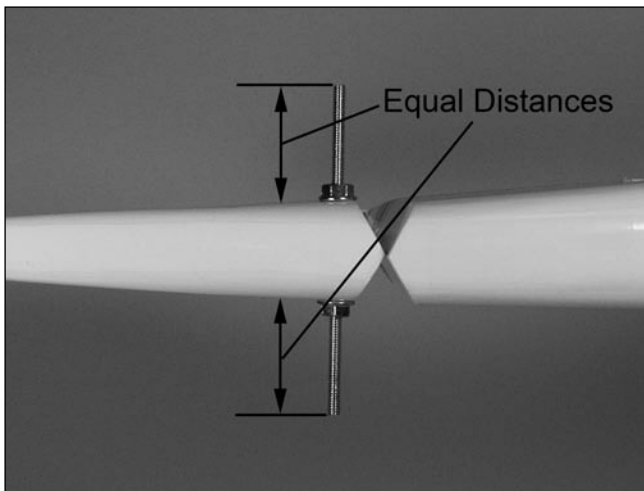

Step 2

Cut the cable into two equal pieces. Prepare one end of the pull-pull cable using the cable, threaded cable end and crimp. The cable passes through the crimp, through the threaded end, then back through the crimp twice. Pull the excess cable tight and use a crimping tool to complete the job.

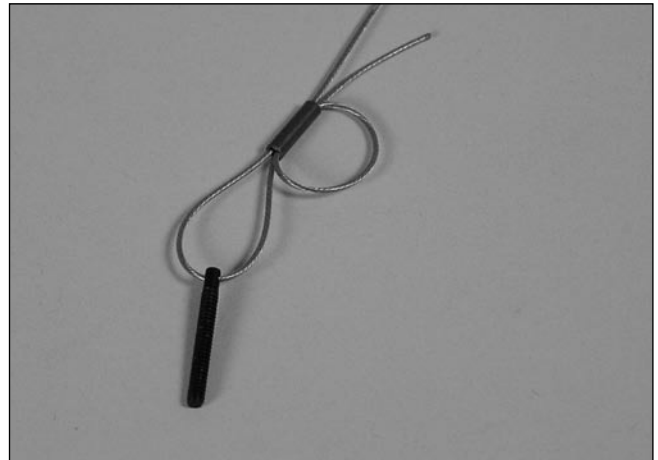

Section 7A – Rudder Servo Installation: Pull-pull

Step 3

Screw the molded swivel link onto the 8-32 screw until the distance from the rudder surface to the top of the link is 3/4".

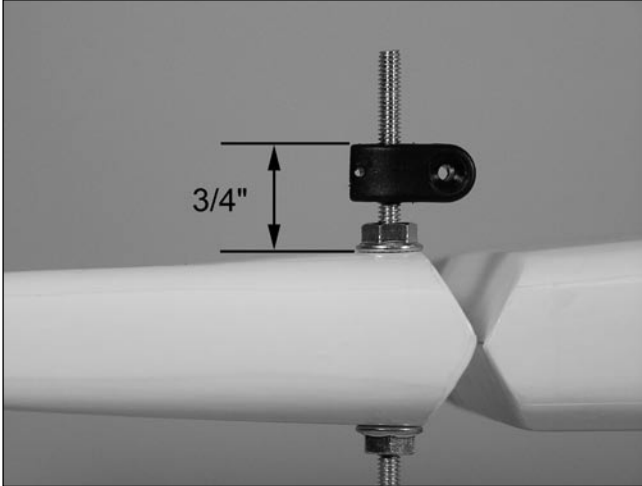

Step 4

Thread the cable end halfway into the ball link. Remove the covering from the fuselage for the cable exit. The exit is located 6" in front of the rudder hinge line, which is below the hole for the stabilizer anti-rotation pin. Pass the cable into the fuselage through the opening.

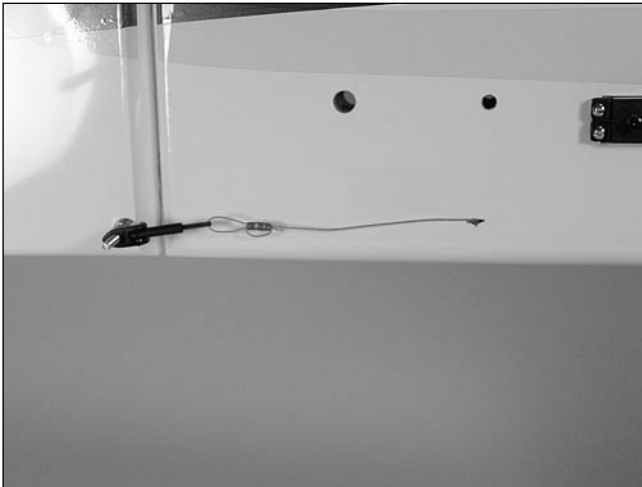

Step 5

Using the screws included with the servo, fasten the servo in place. You may find it helpful to drill 1/16" pilot holes before installing the screws.

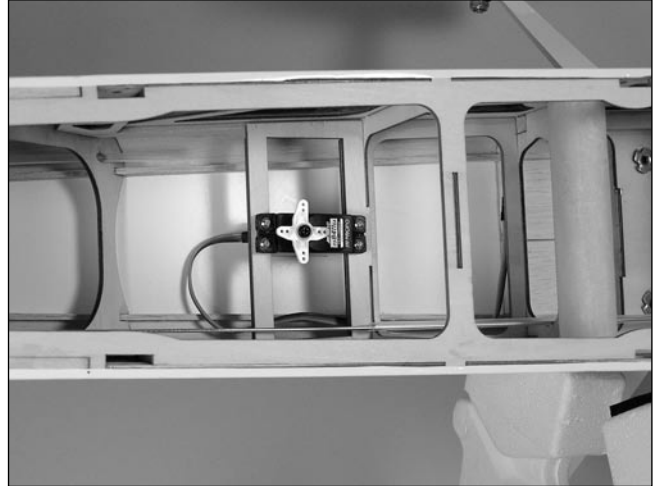

Step 6

Prepare the rudder servo arm by attaching two 4-40 ball links using the 4-40 screws and locknuts.



Section 7A – Rudder Servo Installation: Pull-pull

Step 7

Center the rudder servo and place the servo arm onto the servo. Slide a crimp onto the cable, then a threaded end. Pass the cable back through the crimp.



Step 8

Adjust the position of the threaded end on the cable so it will thread into the ball end and have slight tension on the cable to the rudder. It will take some time to get the position right. Once the position of the end is correct, pass the cable back through the crimp and secure the cable. Thread the end into the ball end.



Step 9

Repeat Steps 2 through 8 to assemble and install the second rudder cable. (Step 5 is only required once.)

Note: The cables will cross inside the fuselage to get the correct geometry.

Step 10

With the radio on, check the operation of the rudder. Adjust the cables so when the rudder servo is centered, the rudder is centered as well. There will be slight tension on the cables to prevent the rudder from wandering. Adjustments can be made at the rudder control horn and at the servo arm. Once adjustments are made, secure the servo arm to the rudder servo using the screw that came with the servo.

Note: Check the tension of the rudder cables before every flying session, as they may stretch over time.

Section 7B – Rudder Servo Installation: Tail Mounted

Required Parts

- Fuselage
- 4" rudder linkage
- Molded swivel link
- 4-40 ball link
- 4-40 locknut
- 8-32 x 2 1/4" control horn screw (1)
- 4-40 x 1/2" socket head screw (2)

Required Tools and Adhesives

- Drill
- Drill bit: 1/16"
- Dental floss or string
- 24" Servo Extensions (JRPA102)
- Hangar 9 3D XL 1/2 Servo Arm 4-40:JR (HAN3578)

The rudder requires a minimum of 120 ounce inch of servo torque. In the prototype ShowTimes we used JR® 8411SA servos with excellent results. Using servos with less torque could result in blowback.

The ShowTime has two options for mounting the rudder servo. For lighter engines a pull-pull system is used. For heavier engines a tail-mounted servo is used. Use the appropriate servo location based on your engine selection. When installing the Saito 1.00 we used the tail mounted servo.

Step 1

Install a 24" servo extension onto the rudder servo. Either tie the servo leads together, using a commercially available connector, or use unwaxed dental floss to secure the extension to prevent it from coming loose during flight.

Step 2

Remove the covering from the fuselage for the rudder servo location. Install the servo in the fuselage tail section with the output shaft to the front as shown in the photo.

Step 3

Using the screws included with the servos, fasten the servos in place. You may find it helpful to drill a 1/16" pilot hole before installing the screws.



Step 4

Mix a small amount of 30-minute epoxy and lightly coat the inside of the hole in the rudder and the 8-32 x 2 1/4" control horn screw. Slide the screw into the hole from side opposite of the rudder servo. Wipe away any excess epoxy on the wing and screw with rubbing alcohol and a paper towel. Screw the 8-32 flange nut in place as shown. Allow the epoxy to fully cure.

Step 5

Screw the molded swivel link onto the 8-32 screw until the distance from the rudder surface to the top of the link is 3/4".

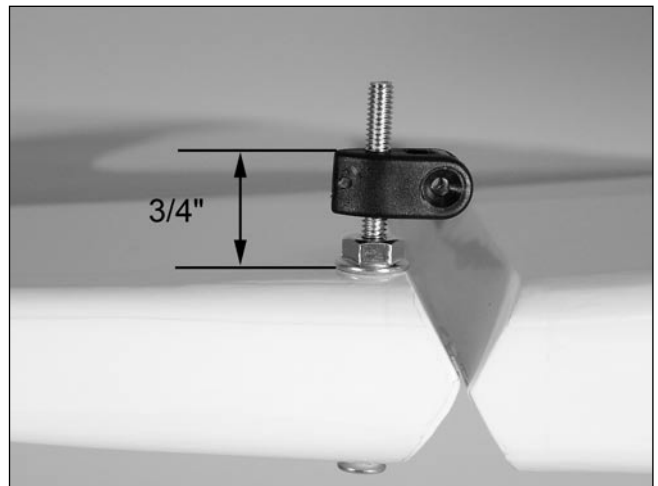

Section 7B – Rudder Servo Installation: Tail Mounted

Step 6

Remove the stock servo arms from the rudder servo and replace it with a Hangar 9 3D XL 1/2 Servo Arm 4-40: JR. The arm faces down as shown. Be sure to use a drop of threadlock on the servo arm screw if using metal-gearred servos.

Step 7

Use the included 4-40 screws and nuts to attach the ball link to the outer hole in the arm. The correct sequence is 4-40 screw, ball link, servo arm, and 4-40 locknut. Be sure to use threadlock.

Step 8

Screw a 4-40 ball link 5 to 6 turns onto a 5" rudder linkage. Screw the opposite end of the linkage into the swivel control horn on the rudder. Adjust the linkage length until the hole in the ball link lines up with the outer hole in the servo arm when the rudder is neutral and the servo arm is centered.

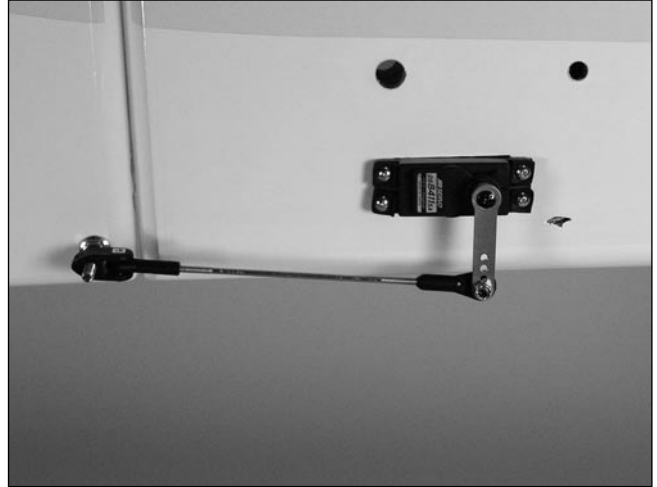

Section 8 – Tail Wheel Installation

Required Parts

- Fuselage
- Tail wheel spring (2)
- Tail wheel assembly
- #4 x 5/8" socket head wood screw (2)

Required Tools and Adhesives

- Drill
- Drill bit: 5/64"
- Felt-tipped pen

Step 1

Position the tail wheel in place as shown, centered on the rear of the fuselage. Using a felt-tipped pen, mark the positions for the mounting screws through the tail wheel bracket.

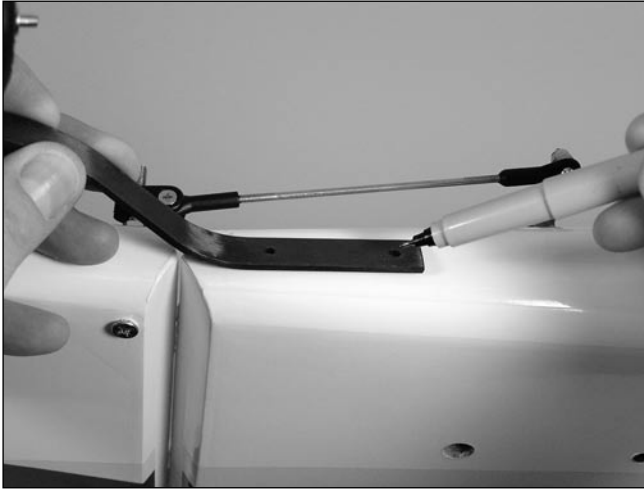

Step 2

Remove the bracket and drill 5/64" pilot holes at the previously marked positions.

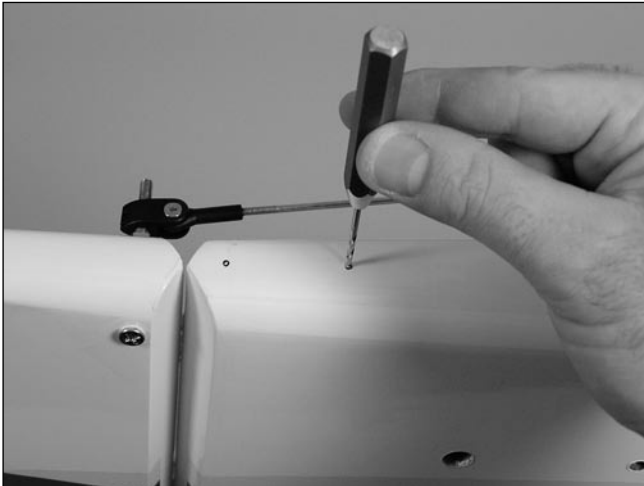

Step 3

Use two #4 x 5/8" sheet metal screws to secure the tail wheel bracket in place. A hardwood plate is positioned in the rear of the fuselage, allowing these screws to be firmly tightened.



Hint: Remove the screws and wick thin CA into the holes to strengthen the threads. When dry, reinstall the screws.

Step 4

The rudder has a hard point 5 1/4" back from the hinge line. Bend the springs so there is tension when attached to the tiller arm and the hard point in the rudder.

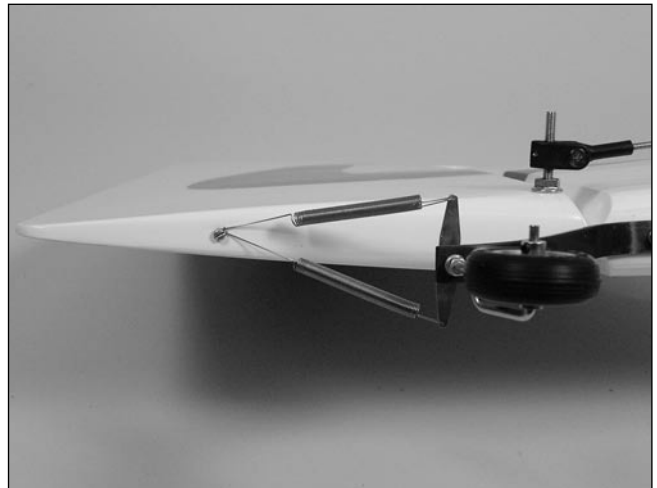

Section 9 – Radio Installation

Required Parts

- Fuselage
- Pushrod keeper

Required Tools and Adhesives

- Velcro straps

Step 1

Wrap the receiver battery and receiver in 1/4" foam. Attach the receiver and battery to the battery tray using Velcro straps to secure the receiver. Route the receiver antenna through the installed antenna tube.

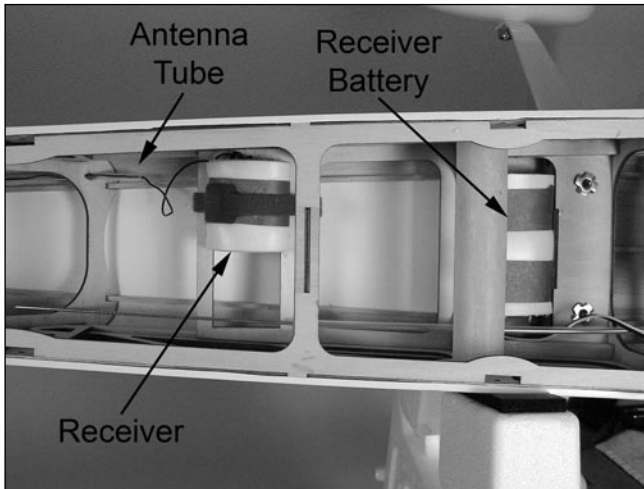

Step 2

Mount the receiver switch in a convenient location in the side of the fuselage. Plug the rudder and elevator servo leads into the receiver, as well as the switch harness.



Note: A piece of plywood has been supplied to help in mounting the receiver and receiver battery. The final location of these items can be located differently to achieve the correct center of gravity.

Step 3

Mount the throttle servo using the hardware provided with the servo. Plug the servo into the receiver and attach the servo arm to the throttle servo.

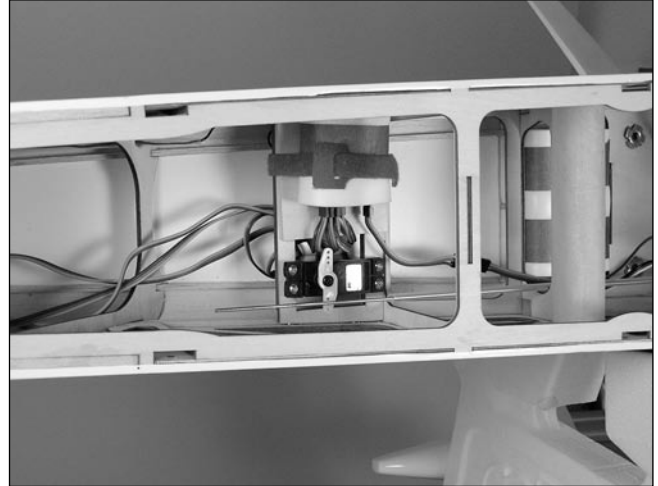

Step 4

Move the servo to the throttle open position using the radio system. Manually move the throttle arm on the carburetor to the open position. Mark the pushrod where it crosses the servo arm. Make a 90-degree bend in the wire and install it into the servo arm.

Step 5

Check the movement of the throttle to verify there is no binding at either low or high throttle. If there is, make the necessary adjustment to eliminate any binding. Secure the pushrod using a pushrod keeper when all adjustments are complete.



Section 10 – Cowling Installation

Required Parts

- Fuselage assembly
- Cowling
- #4 washer (4)
- 1/4" fuel tube (4)
- 4-40 x 1" socket head screw (4)

Required Tools and Adhesives

- Rotary tool with sanding drum
- 2 1/2" spinner and adapters

Step 1

Use cardstock to indicate the location of the engine, needle valve, firewall and any other engine-related items that will need to be accessed with the cowling on.

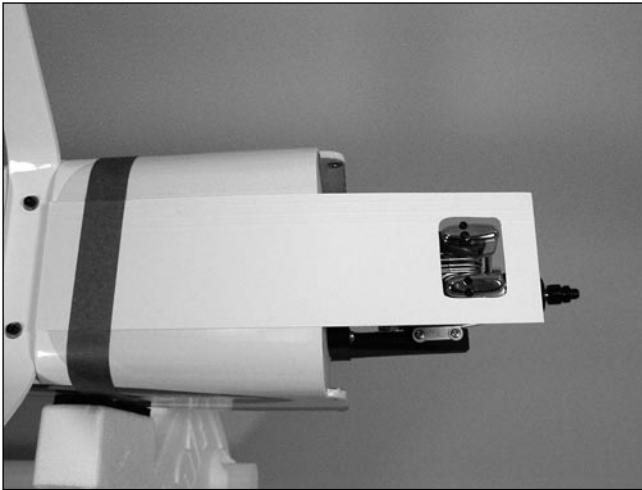

Step 2

Attach the cowling onto the fuselage using four 4-40 x 1" socket head screws, four #4 washers and four pieces of 1/4" long fuel tubing. Transfer the positions from the cardstock onto the cowling.

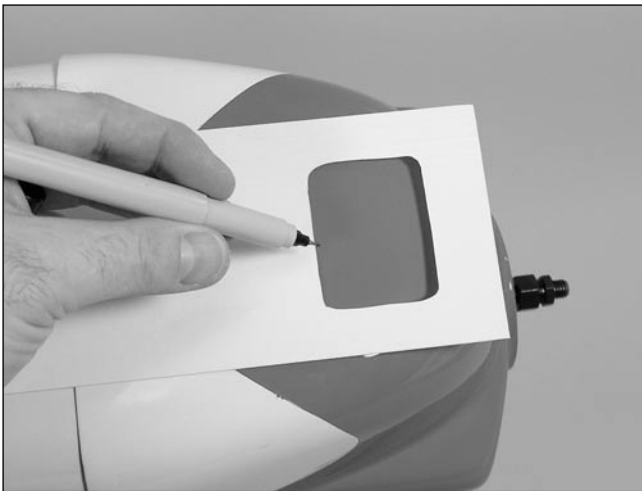

Step 3

Remove the cowl and remove the necessary material to allow access to items such as needle valves, glow plugs, cut-off switches, mufflers, etc. Also add two openings to allow for airflow through the cowling for cooling.

Note: Start by removing only a little material at a time. You can always make the holes bigger as you work. Work until the cowl fits nicely over the engine.



Step 4

Install the propeller and spinner to complete the cowling installation.

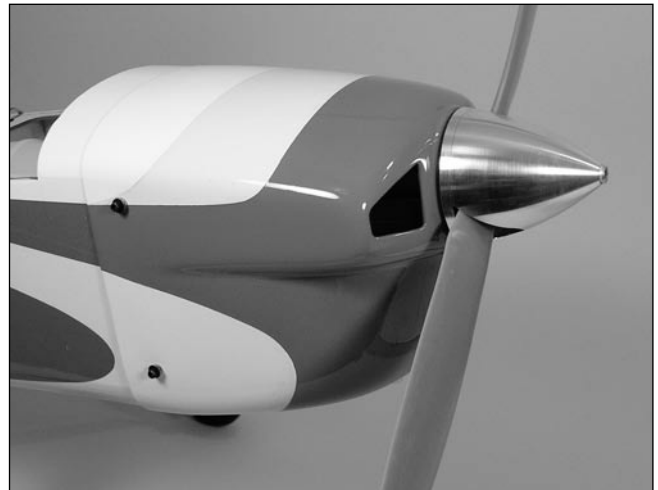

Section 11 – Final Assembly

Required Parts

- Hatch
- 4-40 x 1/2" screw (4)
- Decals
- Side force generator (2)
- Canopy
- #4 washer (4)
- Pilot figure
- #2 x 1/4" screw (4)

Required Tools and Adhesives

- Hex wrench: 3/32"
- Shoo Goo
- Formula 560-canopy glue
- Masking tape

Step 1

Position the canopy onto the canopy hatch. Trace around the canopy and onto the hatch using a felt-tipped pen.

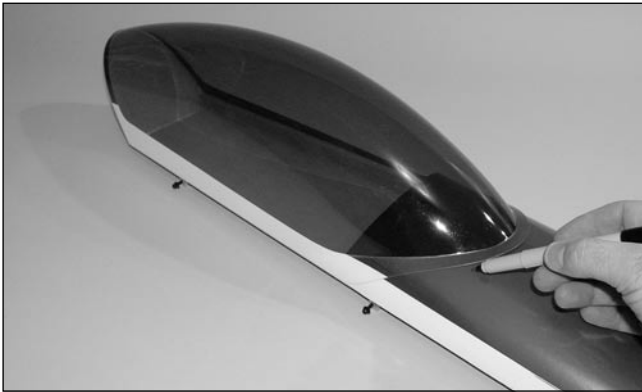

Step 2

Lightly sand the inside edge of the canopy and slightly inside the line drawn on the hatch using medium sandpaper.



Step 3

Apply a bead of RCZ56 Canopy Glue (ZINJ5007) around the inside edge of the canopy. Position the canopy onto the hatch. Use tape to hold the canopy secure until the glue fully cures.

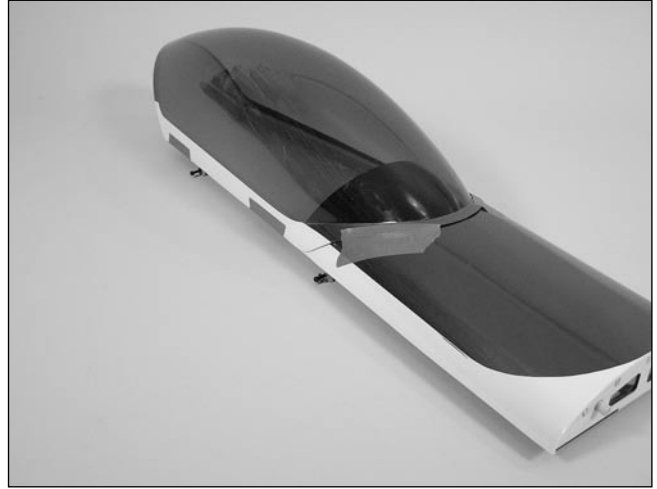

Step 4

If you are not planning on using the side force generators, secure the side force generator plugs to the wing using #2 x 1/4" screws.



Section 11 – Final Assembly

Step 5

To install the side force generators, first remove the plugs. Slide the side force generators partially into the slot in the wing. When the stud is visible, install the thumbscrew to pull the upper and lower side force generators into position.

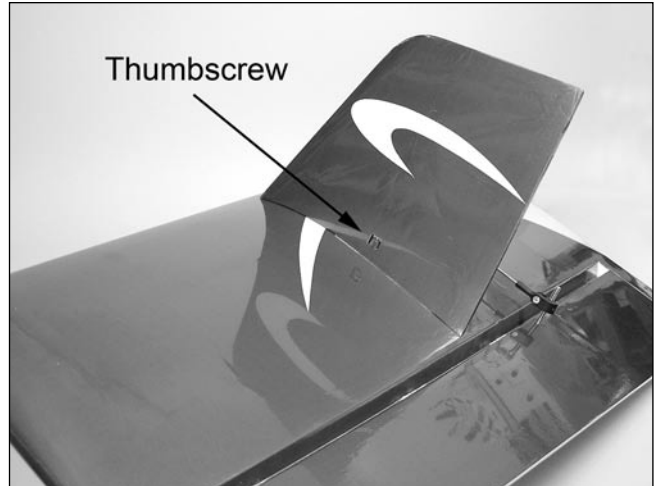
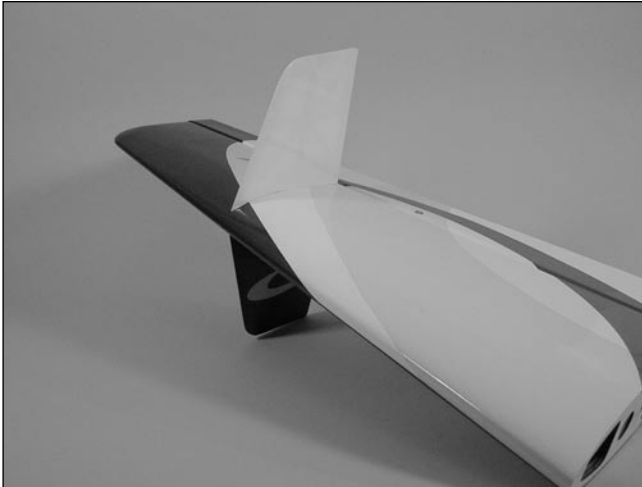

Note: The SFG's can be removed in a few seconds. Try your ShowTime with and without to decide which setup suits your flying style best.

Step 6

Apply the decals to customize your ShowTime.

Flying Information

For detailed information on setting up and flying the ShowTime 4D 90 by Mike McConville, go to www.hangar-9.com.

Balancing the Model

Correctly balancing an aerobatic model is critical to its performance and flight characteristics. Checking the balance on large-scale models is best done with two people.

Step 1

Measure back $7\frac{7}{16}$ " from the leading edge at the root rib and mark the location on the bottom of both wing panels with a felt-tipped pen. This is the recommended center of gravity (CG).

Step 2

Fully assemble the model. With the airplane upright, lift the airplane with your index fingers to find the balance point. The balance point (CG) should be at the marks made on the bottom of the wing. If not, move the receiver battery, receiver, or add the necessary weight to the nose or tail to obtain the correct balance.

Control Throws

Aileron (Measured at inboard end of aileron)

Low	2" (22°) Up	$1\frac{7}{8}$ " (21°) Down
High	$3\frac{3}{4}$ " (45°) Up	$3\frac{5}{8}$ " (43°) Down

Elevator (Measured at trailing edge)

Low	$\frac{5}{8}$ " (9°) Up	$\frac{3}{4}$ " (11°) Down
High	$3\frac{1}{8}$ " (45°) Up	$4\frac{1}{2}$ " (50°) Down

Rudder (Measured at counterbalance)

Low	$1\frac{5}{8}$ " (30°) Right	$1\frac{5}{8}$ " (30°) Left
High	$2\frac{1}{2}$ " (45°) Right	$2\frac{1}{2}$ " (45°) Left

Preflight at the Field

Range Test Your Radio

Step 1

Before going to the field, be sure that your batteries are fully charged, per the instructions included with your radio. Charge both the transmitter and receiver pack for your airplane. Use the recommended charger supplied with your particular radio system, following the instructions provided with the radio. In most cases the radio should be charged the night before going out flying.

Step 2

Before each flying session, be sure to range check your radio. See your radio manual for the recommended range and instructions for your radio system. Each radio manufacturer specifies different procedures for their radio systems. If using a gasoline engine, check the range first with the engine not running and note the distance. Next, start the engine. With the model securely anchored, check the range again. The range test should not be significantly affected. If it is, don't attempt to fly! Have your radio equipment checked out by the manufacturer.

Step 3

Double-check that all controls (aileron, elevator, rudder and throttle) move in the correct direction.

Step 4

Check the radio installation and make sure all the control surfaces are moving correctly (i.e. the correct direction and with the recommended throws). Test run the engine and make sure it transitions smoothly from idle to full throttle and back. Also ensure the engine is tuned according to the manufacturer's instructions, and it will run consistently and constantly at full throttle when adjusted.

Check all the control horns, servo horns, and clevises to make sure they are secure and in good condition. Replace any items that would be considered questionable. Failure of any of these components in flight would mean the loss of your aircraft.

2005 Official AMA National Model Aircraft Safety Code

GENERAL

1) I will not fly my model aircraft in sanctioned events, air shows or model flying demonstrations until it has been proven to be airworthy by having been previously, successfully flight tested.

2) I will not fly my model higher than approximately 400 feet within 3 miles of an airport without notifying the airport operator. I will give right-of-way and avoid flying in the proximity of full-scale aircraft. Where necessary, an observer shall be utilized to supervise flying to avoid having models fly in the proximity of full-scale aircraft.

3) Where established, I will abide by the safety rules for the flying site I use, and I will not willfully and deliberately fly my models in a careless, reckless and/or dangerous manner.

4) The maximum takeoff weight of a model is 55 pounds, except models flown under Experimental Aircraft rules.

5) I will not fly my model unless it is identified with my name and address or AMA number, on or in the model. (This does not apply to models while being flown indoors.)

6) I will not operate models with metal-bladed propellers or with gaseous boosts, in which gases other than air enter their internal combustion engine(s); nor will I operate models with extremely hazardous fuels such as those containing tetranitromethane or hydrazine.

7) I will not operate models with pyrotechnics (any device that explodes, burns, or propels a projectile of any kind) including, but not limited to, rockets, explosive bombs dropped from models, smoke bombs, all explosive gases (such as hydrogen-filled balloons), or ground mounted devices launching a projectile. The only exceptions permitted are rockets flown in accordance with the National Model Rocketry Safety Code or those permanently attached (as per JATO use); also those items authorized for Air Show Team use as defined by AST Advisory Committee (document available from AMA HQ). In any case, models using rocket motors as a primary means of propulsion are limited to a maximum weight of 3.3 pounds and a G series motor. (A model aircraft is defined as an aircraft with or without engine, not able to carry a human being.)

8) I will not consume alcoholic beverages prior to, nor during, participation in any model operations.

9) Children under 6 years old are only allowed on the flight line as a pilot or while receiving flight instruction.

RADIO CONTROL

1) I will have completed a successful radio equipment ground range check before the first flight of a new or repaired model.

2) I will not fly my model aircraft in the presence of spectators until I become a qualified flier, unless assisted by an experienced helper.

3) At all flying sites a straight or curved line(s) must be established in front of which all flying takes place with the other side for spectators. Only personnel involved with flying the aircraft are allowed at or in the front of the flight line. Intentional flying behind the flight line is prohibited.

4) I will operate my model using only radio control frequencies currently allowed by the Federal Communications Commission. (Only properly licensed Amateurs are authorized to operate equipment on Amateur Band frequencies.)

2005 Official AMA National Model Aircraft Safety Code

- 5) Flying sites separated by three miles or more are considered safe from site-to site interference, even when both sites use the same frequencies. Any circumstances under three miles separation require a frequency management arrangement, which may be either an allocation of specific frequencies for each site or testing to determine that freedom from interference exists. Allocation plans or interference test reports shall be signed by the parties involved and provided to AMA Headquarters. Documents of agreement and reports may exist between (1) two or more AMA Chartered Clubs, (2) AMA clubs and individual AMA members not associated with AMA Clubs, or (3) two or more individual AMA members.
- 6) For Combat, distance between combat engagement line and spectator line will be 500 feet per cubic inch of engine displacement. (Example: .40 engine = 200 feet.); electric motors will be based on equivalent combustion engine size. Additional safety requirements will be per the RC Combat section of the current Competition Regulations.
- 7) At air shows or model flying demonstrations, a single straight line must be established, one side of which is for flying, with the other side for spectators.
- 8) With the exception of events flown under AMA Competition rules, after launch, except for pilots or helpers being used, no powered model may be flown closer than 25 feet to any person.
- 9) Under no circumstances may a pilot or other person touch a powered model in flight.

Organized RC Racing Event

- 10) An RC racing event, whether or not an AMA Rule Book event, is one in which model aircraft compete in flight over a prescribed course with the objective of finishing the course faster to determine the winner.
- A. In every organized racing event in which contestants, callers and officials are on the course:
1. All officials, callers and contestants must properly wear helmets, which are OSHA, DOT, ANSI, SNELL or NOCSAE approved or comparable standard while on the racecourse.
 2. All officials will be off the course except for the starter and their assistant.
 3. "On the course" is defined to mean any area beyond the pilot/staging area where actual flying takes place.
- B. I will not fly my model aircraft in any organized racing event which does not comply with paragraph A above or which allows models over 20 pounds unless that competition event is AMA sanctioned.
- C. Distance from the pylon to the nearest spectator (line) will be in accordance with the current Competition Regulations under the RC Pylon Racing section for the specific event pending two or three pylon course layout.
- 11) RC night flying is limited to low-performance models (less than 100 mph). The models must be equipped with a lighting system that clearly defines the aircraft's attitude at all times.

HANGAR 9™

HORIZON
H O B B Y

© 2005 Horizon Hobby, Inc.
4105 Fieldstone Road
Champaign, Illinois 61822
(877) 504-0233
horizonhobby.com