O.S. ENGINE

FS-26S & FS-40S

FOUR CYCLE ENGINE

OWNER'S INSTRUCTION MANUAL

It is of vital importance, before attempting to operate your engine, to read the general **'SAFETY INSTRUCTIONS AND WARNINGS'** section on pages 2-6 of this booklet and to strictly adhere to the advice contained therein.

- Also, please study the entire contents of this instruction manual, so as to familiarize yourself with the controls and other features of the engine.
- Keep these instructions in a safe place so that you may readily refer to them whenever necessary.
- It is suggested that any instructions supplied with the aircraft, radio control equipment, etc., are accessible for checking at the same time.



CONTENTS

SAFETY INSTRUCTIONS AND WARNINGS -----2~6 ABOUT YOUR O.S. ENGINE	RUNNING -IN ----- 21
INTRODUCTION,BASIC ENGINE PARTS ----- 7	CARBURETOR ----- 22~23
INSTALLATION ----- 8	CARBURETOR AIR-BLEED ADJUSTMENT ----- 24
INSTALLATION OF CHOKE ROD, NEEDLE VALVE EXTENSION, EXHAUST PIPE ADJUSTMENT(FS-26S) ----- 9	TROUBLE SHOOTING WHEN THE ENGINE FAILS TO START ----- 25~26
SILENCER, LINKAGE OF THROTTLE LEVER -----10	VALVE ADJUSTING ----- 27~29
BEFORE STARTING ----- 11~12	CARE AND MAINTENANCE ----- 30
FUEL AND PRESSURE LINES ----- 12	THREE VIEW DRAWING ----- 31
ADVICE ON SELECTION OF FUEL, GLOEPLUG & PROPELLER -----13~14	ENGINE EXPLODED VIEW ----- 32~35
STARTING THE ENGINE -----15~21	CARBURETOR EXPLODED VIEW & PARTS LIST ----- 36
	GENUINE PARTS & ACCESSORIES ----- 37
	MEMO ----- 38

SAFETY INSTRUCTIONS AND WARNINGS ABOUT YOUR O.S. ENGINE

Remember that your engine is not a "toy", but a highly efficient internal-combustion machine whose power is capable of harming you, or others, if it is misused.

As owner, you, alone, are responsible for the safe operation of your engine, so act with discretion and care at all times.

If at some future date, your O.S. engine is acquired by another person, we would respectfully request that these instructions are also passed on to its new owner.

- The advice which follows is grouped under two headings according to the degree of damage or danger which might arise through misuse or neglect.



WARNINGS

These cover events which might involve serious (in extreme circumstances, even fatal) injury.



NOTES

These cover the many other possibilities, generally less obvious sources of danger, but which, under certain circumstances, may also cause damage or injury.



WARNINGS

- Never touch, or allow any object to come into contact with, the rotating propeller and do not crouch over the engine when it is running.



- A weakened or loose propeller may disintegrate or be thrown off and, since propeller tip speeds with powerful engines may exceed 600 feet(180 metres) per second, it will be understood that such a failure could result in serious injury, (see 'NOTES' section relating to propeller safety).

- Model engine fuel is poisonous. Do not allow it to come into contact with the eyes or mouth. Always store it in a clearly marked container and out of the reach of children.



- Model engine fuel is also highly flammable. Keep it away from open flame, excessive heat, sources of sparks, or anything else which might ignite it. Do not smoke or allow anyone else to smoke, near to it.



- Never operate your engine in an enclosed space. Model engines, like automobile engines, exhaust deadly carbon-monoxide. Run your engine only in an open area.
- Model engines generate considerable heat. Do not touch any part of your engine until it has cooled. Contact with the muffler (silencer), cylinder head or exhaust header pipe, in particular, may result in a serious burn.





NOTES

- This engine was designed for model aircraft. Do not attempt to use it for any other purpose.
- Mount the engine in your model securely, following the manufacturers' recommendations, using appropriate screws and lock-nuts.
- Be sure to use the silencer (muffler) supplied with the engine. Frequent exposure to an open exhaust may eventually impair your hearing. Such noise is also likely to cause annoyance to others over a wide area.
- If you remove the glowplug from the engine and check its condition by connecting the battery leads to it, do not hold the plug with bare fingers. Use an appropriate tool or a folded piece of cloth.
- Install a top-quality propeller of the diameter and pitch specified for the engine and aircraft. Locate the propeller on the shaft so that the curved face of the blades faces forward-i.e. in the direction of flight. Firmly tighten the propeller nut, using the correct size wrench.



NOTES

- Always check the tightness of the propeller nut and retighten it, if necessary, before restarting the engine, particularly in the case of four-stroke-cycle engines. If a safety locknut assembly is provided with your engine, always use it. This will prevent the propeller from flying off in the event of a "backfire", even if it loosens.
- If you install a spinner, make sure that it is a precision made product and that the slots for the propeller blades do not cut into the blade roots and weaken them.
- Preferably, use an electric starter. The wearing of safety glasses is also strongly recommended.
- Discard any propeller which has become split, cracked, nicked or otherwise rendered unsafe. Never attempt to repair such a propeller: destroy it. Do not modify a propeller in any way, unless you are highly experienced in tuning propellers for specialized competition work such as pylon-racing.
- Take care that the glow plug clip or battery leads do not come into contact with the propeller. Also check the linkage to the throttle arm. A disconnected linkage could also foul the propeller.
- After starting the engine, carry out any needle-valve readjustments from a safe position behind the rotating propeller. Stop the engine before attempting to make other adjustments to the carburettor.



NOTES

- Adjust the throttle linkage so that the engine stops when the throttle stick and trim lever on the transmitter are fully retarded. Alternatively, the engine may be stopped by cutting off the fuel supply. Never try to stop the engine physically.
- Take care that loose clothing (ties, shirt sleeves, scarves, etc.) do not come into contact with the propeller. Do not carry loose objects (such as pencils, screwdrivers, etc.) in a shirt pocket from where they could fall through the propeller arc.
- Do not start your engine in an area containing loose gravel or sand. The propeller may throw such material in your face and eyes and cause injury.
- For their safety, keep all onlookers (especially small children) well back (at least 20 feet or 6 meters) when preparing your model for flight. If you have to carry the model to the take-off point with the engine running, be especially cautious. Keep the propeller pointed away from you and walk well clear of spectators.
- Warning! Immediately after a glowplug-ignition engine has been run and is still warm, conditions sometimes exist whereby it is just possible for the engine to abruptly restart if the propeller is casually flipped over compression WITHOUT the glowplug battery being reconnected. Remember this if you wish to avoid the risk of a painfully rapped knuckle!

INTRODUCTION

The FS Series engines are up-to-date overhead-valve four-stroke-cycle engines for model aircraft use and are the outcome of a long period of technical development. The FS Series engines are produced by the world's oldest and largest model engine manufacturing company; a company which also pioneered the quantity production of model four-cycle engines.

Accessories

FS-26S

- Silencer Body
- Choke rod
- Silicone tubing

FS-40S

- Silencer Assembly
- Choke rod
- Silicone tubing

INSTALLING THE GLOWPLUG

Install washer on glowplug and insert carefully into cylinder-head, making sure that it is not cross-threaded before tightening firmly.

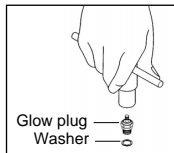

BASIC ENGINE PARTS

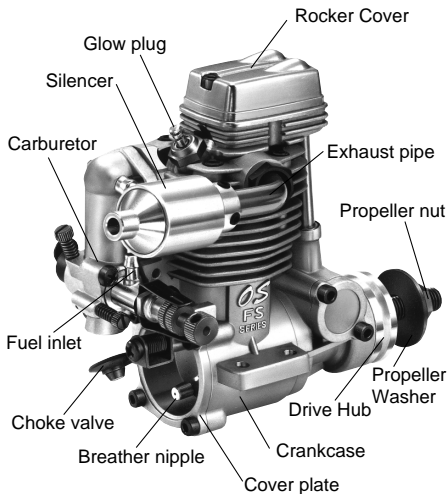

INSTALLATION

Installation in the model

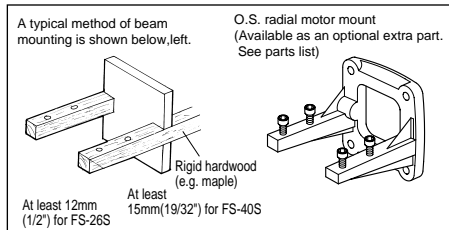

Make sure that the mounting beams are parallel and that their top surfaces are in the same plane.

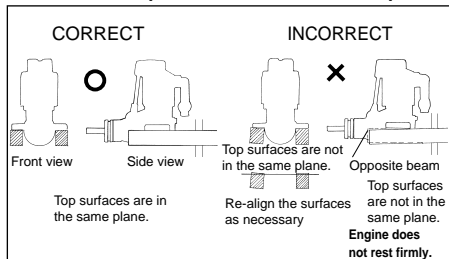

How to fasten the mounting screws.

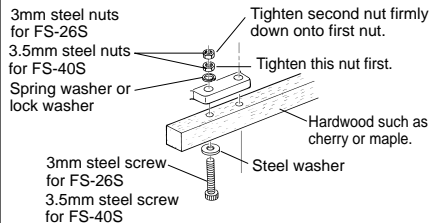

Hardwood mounting beams

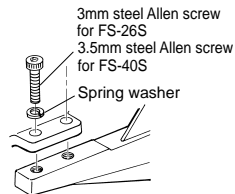

O.S. radial motor mount (cast aluminum)

INSTALLATION OF CHOKE ROD

The FS Series engines are equipped with self-reopening choke valves.

Cut the choke rod (supplied) to the length indicated, then secure the rod by tightening the set screw, using 1.5mm Allen wrench (supplied), after installing the engine.

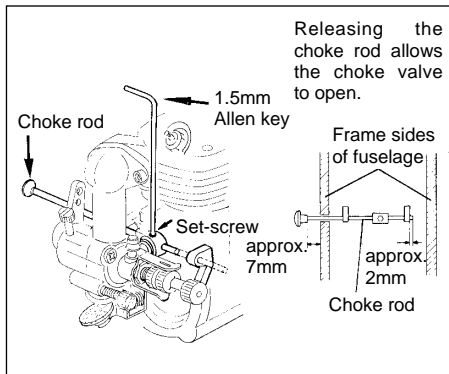

NEEDLE VALVE EXTENSION

The needle-valve supplied with this engine is designed to incorporate an extension so that, when the engine is enclosed within the fuselage, the needle-valve may be adjusted from the outside. Cut the L-shaped rod supplied to the required length, insert it into needle's centre hole and secure it by tightening the set-screw in the needle-valve knob with 1.5mm. Allen key supplied.

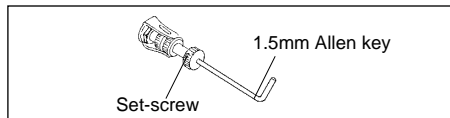

EXHAUST PIPE ADJUSTMENT(FS-26S)

The direction of the exhaust pipe may be altered in accordance with individual installation requirements. The angle is easily adjusted by loosening the nut that secures the exhaust pipe to the culinder head. Use the 10mm spanner supplied. Recheck the tightness of the nut after the engine has been run, but take care not to touch the exhaust-pipe as it becomes very hot.

SILENCER

The FS-26S and FS-40S are supplied with silencers as standard equipment.

Installation for FS-26S

Slide the silencer over the exhaust pipe, and secure it with two set-screws supplied with the silencer. Re-check tightness of screws when engine is hot.

Installation for FS-40S

Screw the exhaust header pipe into the exhaust port until it "bottoms", then unscrew it just sufficiently to achieve the required exhaust outlet angle. Secure the pipe in this position by tightening the locknut firmly against the cylinder head with the wrench supplied. Then, screw the silencer onto the end of the header pipe and tighten locknut firmly. Re-check tightness of locknuts when engine is hot.

LINKAGE OF THROTTLE LEVER

First, ensure that the throttle rotor is fully closed when the throttle-lever is in the closed position. Adjust rotor stop screw if necessary. Then couple the lever to the throttle-servo so that the rotor is fully closed when the transmitter throttle stick and trim lever are in the fully retarded position.

BEFORE STARTING

Tools, accessories, etc.

The following items are necessary for operating the engine.

1 Fuel

Model glowplug engine fuel of good quality, preferably containing a small percentage of nitromethane. (See "Advice on selection of fuel, glowplug and propeller")

2 Glowplug

O.S. Type F glowplug is installed in the engine.

3 Propeller

Suggested propellers are shown in the ADVICE ON SELECTION OF FUEL & PROPELLER section.

4 Glowplug battery

The power source for heating the glowplug may be either a large heavy-duty 1.5volt dry cell, or preferably, a 2-volt rechargeable lead-acid cell (accumulator).

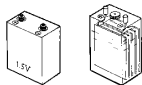

1.5 volt heavy-duty dry battery or 2 volt rechargeable lead-acid cell (at least 5Ah)

If a 2-volt cell is employed, use a resistance wire, as shown, to reduce applied voltage, otherwise element will overheat and burn out.

Warning (Very hot)

Never touch the nichrome wire while the battery is connected.

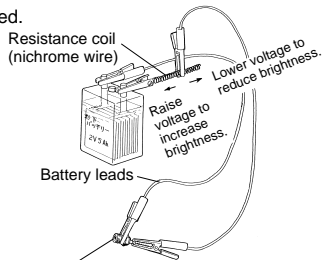

Adjust applied voltage by changing the position of clip on resistance coil until glowplug element is glowing bright red.

5 Plug wrench

Used for tightening glowplug.

The O.S. long plug wrench is available as an optional accessory.

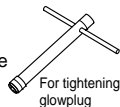

For tightening glowplug

6 Battery leads

These are used to conduct current from the battery to the glowplug. Basically, two leads, with clips, are required, but, for greater convenience, twin leads with special glowplug connectors, as shown on the right, are commercially available.



Battery leads

7 Fuel tank

For installation in the model, a 120cc(4.2oz.) for FS-26S, a 150cc(5oz.) for FS-40S tank is suggested.



Fuel bulb

8 Fuel bottle or pump

For filling the fuel tank, a simple, polyethylene "squeeze" bottle, with a suitable spout, is all that is required. Alternatively, one of the purpose-made manual or electric fuel pumps may be used to transfer fuel directly from your fuel container to the fuel tank.

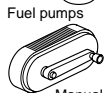

Fuel pumps



Manual

Electric

9 Electric starter and starter battery

An electric starter is recommended for starting.

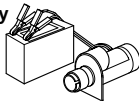

10 Fuel can filter

Install a filter in the outlet line of your refuelling container to prevent entry of foreign matter into the fuel tank. (Refer to **STARTING THE ENGINE** section.)



Fuel Can Filter

11 Silicone tubing

This is required for the connection between the fuel tank and engine.

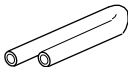

FUEL AND PRESSURE LINES

Connect suitable lengths of silicone tubing, as illustrated, after installing the engine.

Attention to tank height

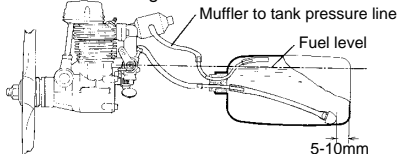

Locate the fuel tank so the top of the tank is 5-10mm (1/4-3/8") above the level of the needle-valve.

Note: When cutting silicone tubing...

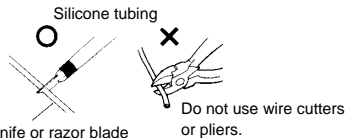

Use knife or razor blade

Do not use wire cutters or pliers.

*If you should need to clean the silicone tubing, use methanol or glow-fuel, not gasoline or kerosene.

Silencer (muffler) pressurized fuel system

To reduce variation in fuel "head" and ensure steady fuel delivery at the carburettor, it is advisable to employ a silencer (muffler) pressurized fuel system, i.e. to use the silencer outlet nipple to pressurize the fuel tank as shown at left.

ADVICE ON SELECTION OF FUEL, GLOWPLUG & PROPELLER

Fuel

Use a good quality commercial fuel or one of the blends shown in the table. Fuel "A" is suitable for running-in and ordinary use. Fuel "B" is for use when more power is required and for improved flexibility. Note that even a small quantity of nitromethane (3-5%) will improve flexibility, making the needle-valve adjustment less critical and improving throttle response. Use only materials of the highest purity. Synthetic oils are permissible but are less tolerant of a "lean run" than castor-oil. If, therefore, a synthetic lubricant is used in the fuel, readjust the needle-valve to a slightly richer setting, as a safety measure, in case the fuel/air mixture becomes too lean through maneuvers in flight. Higher nitro fuel is used, the engine should be checked out to make sure that it is sufficiently run-in to operate on that particular fuel without overheating. Do not use fuels containing less than 18% lubricant.

	A	B
Methanol	75%	65%
Castor Oil	20%	20%
Nitromethane	5%	15%

Reminder!



Model engine fuel is poisonous. Do not allow it to come into contact with the eyes or mouth. Always store it in a clearly marked container and out of the reach of children.



Model engine fuel is also highly flammable. Keep it away from open flame, excessive heat, sources of sparks, or anything else which might ignite it. Do not smoke, or allow anyone else to smoke, near to it.

PROPELLER

Suggested propeller sizes are given in the table. As the ideal propeller diameter, pitch and blade area vary according to the size, weight and type of model, final propeller selection will require in flight experimentation.

Reminder!



Never touch, or allow any object to come into contact with, the rotating propeller and do not crouch over the engine when it is running.

	Sport & Aerobatic	Trainer & Sport
FS-26S	9x6~7	9x6~7,10x6,10.5x6 8x6(3blade)
FS-40S	10x7~7.5,11x6 9x7(3blade)	10x7,10.5x6,11x7 12x5~6,10x7(3blade)

GLOWPLUG

The FS-26S and FS-40S are supplied with an O.S. Type F glowplug, specially designed for O.S. four-stroke engines.

The role of the glowplug

With a glowplug engine, ignition is initiated by the application of a 1.5-volt power source. When the battery is disconnected, the heat retained within the combustion chamber remains sufficient to keep the plug filament glowing, thereby continuing to keep the engine running. Ignition timing is 'automatic' : under reduced load, allowing higher rpm, the plug becomes hotter and, appropriately, fires the fuel/air charge earlier; conversely, at reduced rpm, the plug become cooler and ignition is retarded.

Glowplug life

Particularly in the case of very high performance engines, glowplugs must be regarded as expendable. However, plug life can be extended and engine performance maintained by careful use, i.e.:

- Install a plug suitable for the engine.
- Use fuel containing a moderate percentage of nitromethane unless more is essential for racing events.
- Do not run the engine too lean and do not leave the battery connected while adjusting the needle.

When to replace the glowplug

Apart from when actually burned out, a plug may need to be replaced because it no longer delivers its best performance, such as when:

- Filament surface has roughened and turned white.
- Filament coil has become distorted.
- Foreign matter has adhered to filament or plug body has corroded.
- Engine tends to cut out when idling.
- Starting qualities deteriorate.

STARTING THE ENGINE

Preparations

① Installing the glowplug

Install the washer on the glowplug and screw carefully into cylinder-head, making sure that it is not cross-threaded before tightening firmly.

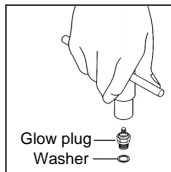

② Installing the propeller

There is a risk, particularly with four-stroke engines, of the propeller flying off if the propeller nut loosens due to detonation or "knocking" when the engine is run too lean or under too heavy a load. To prevent this from happening even if the propeller itself should slip or loosen, it is recommended to use the special Propeller Locknut Set (optional extra) with the FS-40S.

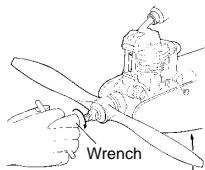

Tighten the propeller nut firmly so that compression is first felt around this position (i.e. with blades horizontal) when turning the propeller in the direction of arrow.

③ Filling the fuel tank

Re-connect fuel line to engine after tank is filled.

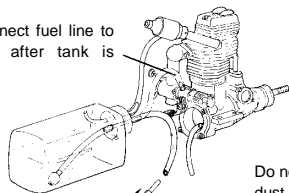

Do not let dirt or dust enter fuel can.

Disconnect fuel line from the fuel inlet, and connect it to the tubing from the fuel pump.

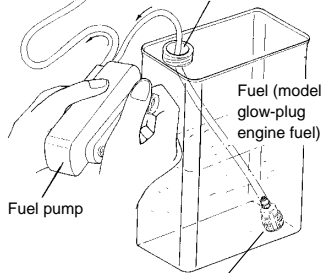

Use a fuel can filter (e.g. O.S. Super Filter).

Starting

④ Opening and closing of the needle-valve

Turn needle-valve clockwise to close (for leaner mixture).

Turn needle-valve counter-clockwise to open (for richer mixture).

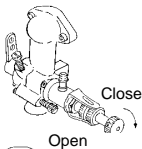

⑤ Setting the needle-valve

Turn the needle-valve in the direction of arrow slowly, without forcing, until it stops.

The position where the needle-valve stops is the fully closed position. It may be convenient to remember the position of the mark or set-screw at this time.

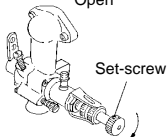

Turn the needle-valve in the direction of arrow from the closed position.

FS-26S (3 to 3-1/2 turns)

FS-40S (2-1/2 to 3 turns)

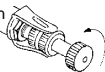

⑥ Open the throttle fully

Fully closed position Fully opened position

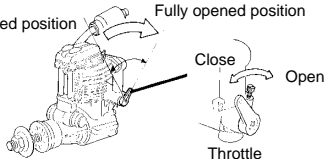

⑦ Priming

Fuel will flow from tank to carburettor as propeller is turned.

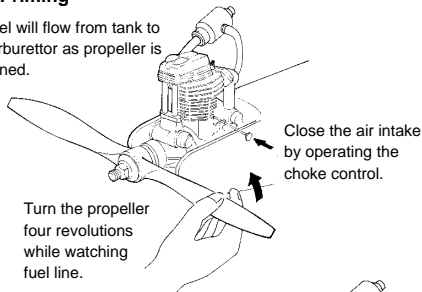

Turn the propeller 3 to 4 turns counter-clockwise smartly by finger in the direction of arrow. Turn approx. 10 turns when the engine is cold.

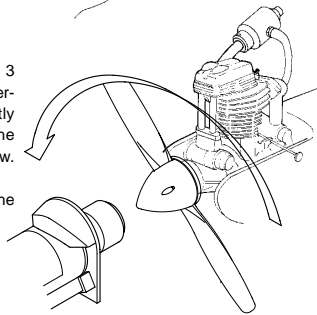

8 Hold model securely when starting

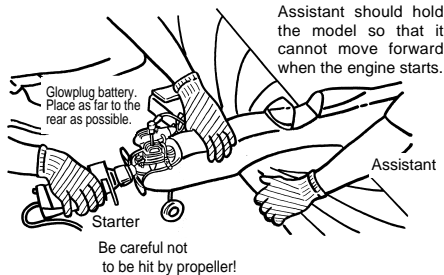

9 Setting the throttle

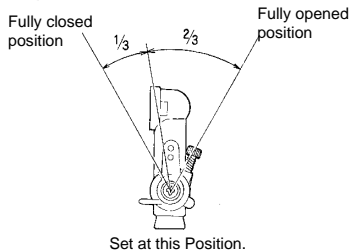

10 Heat glowplug

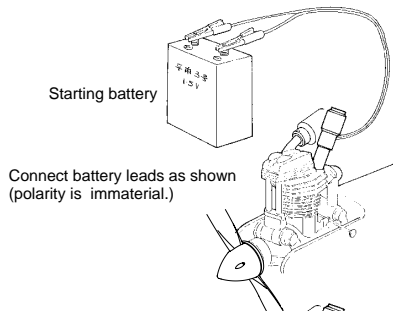

11 Apply electric starter

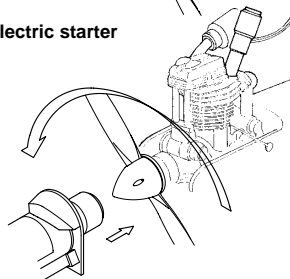

Check that the throttle is one-third open from the fully closed position. Bring the starter into contact with the spinner nut or spinner and depress the starter switch for one or two seconds. Repeat if necessary. When the engine fires, withdraw the starter immediately.

Attention: Never place your finger over the carburettor intake when applying the starter. Such an action will cause an excess quantity of fuel to be drawn into the cylinder and result in hydraulic lock that may damage the engine.

12 Engine starts



BEWARE of
the rotating
propeller.

In the interests of safety, keep your face and other parts of the body away from the vicinity of the propeller.

13 Needle-valve adjustment(1)

Slowly advance throttle to its fully open position, then gradually close the needle-valve until the exhaust sound changes pitch.

Listen to the sound
carefully.

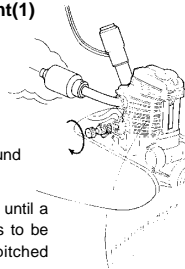

Close the needle-valve gradually until a high-pitched exhaust note begins to be superimposed on the lower-pitched sound.

14 Disconnect battery leads

Disconnect the battery leads from the engine with care so that the plug clip does not touch the rotating pro-peller.

If the engine stops when battery leads are disconnected, close the needle-valve a little (approx. 45°) further, and restart the engine.

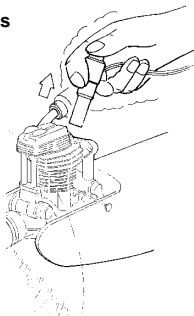

15 Needle-valve adjustment(2)

As the needle-valve is closed beyond the initial readjustment, the rpm of the engine will be increased and a continuous high-pitched exhaust note, only, will be heard.

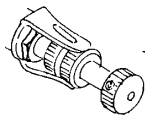

Key to the needle-valve adjustment.
(Turn 15-30° at a time.)

Turn the needle-valve 15-30° in the direction of arrow, and wait momentarily for the change of r.p.m.

After the rpm of the engine increases, turn the needle-valve another 10-15° and wait for the next change of r.p.m.

As the speed of the engine does not instantly change with needle-valve readjustment, small movements, with pauses between, are necessary to arrive at the optimum setting.

16 Needle-valve adjustment(Summary)

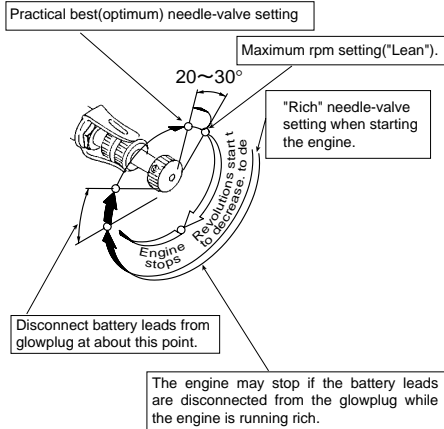

NOTE: The above sketch is for reference purposes only.
Actual needle positions may differ from those shown.

On starting from cold, with the needle-valve set at the rich starting position:

a good deal of white smoke is emitted.

As the needle-valve is closed and the r.p.m. increases

Exhaust smoke will be less dense and grey in color.

Further needle-valve closure:

revolutions will increase and exhaust smoke will be reduced.

Finally:

maximum rpm is reached and will fall off (or engine will stop) if needle -valve is closed any further. Exhaust gas will be very light.

Now, re-open needle-valve 20-30°

This will produce the practical best (i.e. optimum)rpm setting (lower than maximum rpm). A light grey exhaust emission may be observed.

Take note of this position of the needle-valve.

Subsequent starting procedure

Once the optimum needle-valve setting has been established (see 16 "Needle-valve adjustment-Summary") the procedure for starting is simplified as follows:

- 1) Open the needle-valve one half-turn (180°) from the optimum setting.
- 2) Open the throttle fully, place your finger over the carburettor intake and rotate the propeller through two revolutions to prime the engine.
- 3) Set the throttle one-third open from the fully closed position, energize the glowplug and apply the starter. When the engine starts, re-open the throttle and re-adjust the needle-valve to the optimum setting.

Note: When re-starting the engine on the same day, provided that atmospheric conditions have not changed significantly, it may be practicable to re-start the engine on its optimum (running) setting. Also, if the engine is being re-started immediately after a run (i.e.hot), priming should not be necessary.

17 How to stop the engine

Close the throttle to reduce to the lowest possible r.p.m.

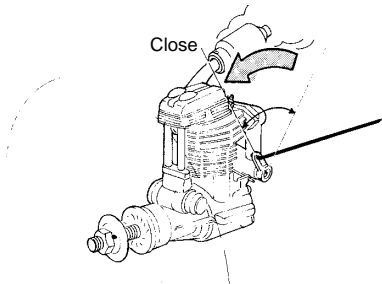

With the transmitter throttle trim lever fully retarded, adjust the throttle servo linkage so that the throttle rotor is fully closed (i.e. engine stopped) when the stick is fully retarded.

RUNNING-IN ("Breaking-in")

All internal-combustion engines benefit, to some degree, from extra care when they are run for the first few times - known as running-in or breaking-in. This is because the working parts of a new engine take a little time to settle down after being subjected to high temperatures and stresses. However, because O.S. engines are made with the aid of the finest modern precision machinery and from the best and most suitable materials, only a very short and simple running-in procedure is required and can be carried out with the engine installed in the model. The process is as follows:

- 1) Start the engine and, with the throttle fully open, open the needle-valve an extra half turn (180°) from the optimum setting. This will produce a rich mixture that will result in cooler running. Allow the engine to run out a full tank on the ground. (Avoid dusty surroundings.)
- 2) Now fly the model with the needle-valve re-set 20-30 degrees open from the optimum setting (i.e. $40-60^\circ$ from the highest rpm setting).
- 3) Close the needle-valve very slightly on successive flights so that the engine is running on its optimum needle setting at the fifth or sixth flight.

CARBURETTOR

These engines are equipped with a throttle type carburettor which provides a wide range of engine speed control. With the throttle lever linked to a suitable servo in the model, movement of the throttle control on the transmitter will enable engine to be varied, proportionally, from idling speed to full power.

The carburettor of your engine has been factory set for the approximate best results and no adjustment (except to the needle-valve) should be required provided that the fuel tank is correctly located, as previously described. After the engine has been run-in, check the operation of the throttle according to the following chart. Re-adjust the controls only when necessary.

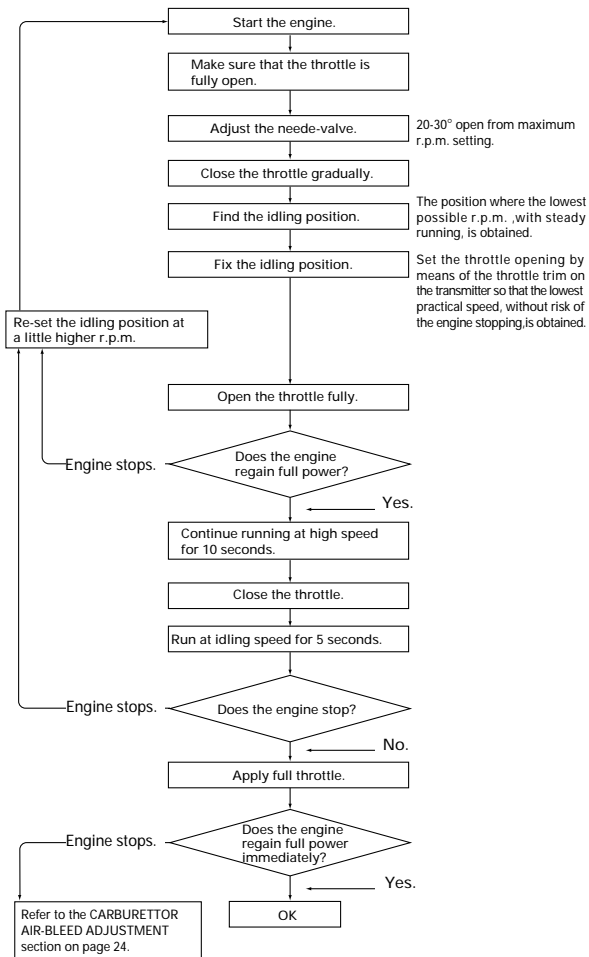

CARBURETTOR AIR-BLEED ADJUSTMENT

Pre-Flight Check

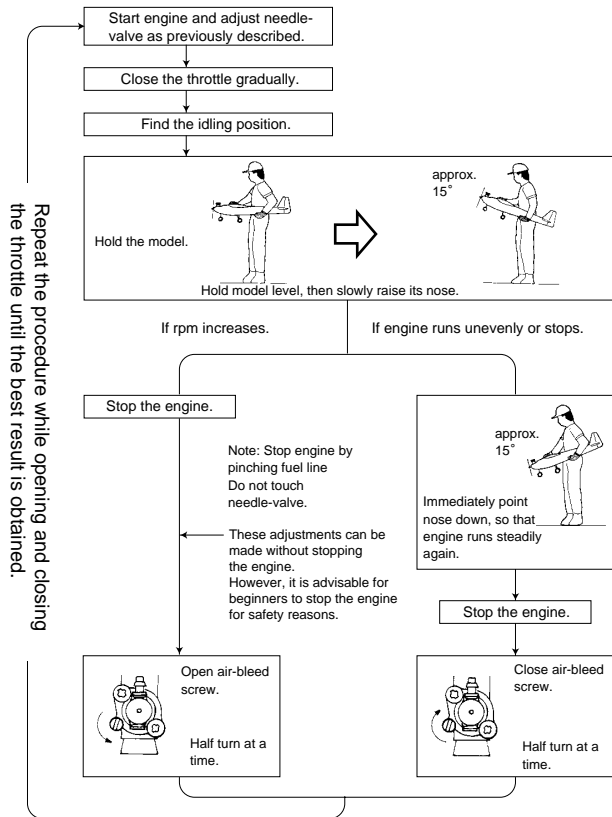

Attention: Do not leave the glowplug connected to the battery while adjusting the carburettor throttle.

TROUBLE SHOOTING WHEN THE ENGINE FAILS TO START

Four key points

For quick, reliable starting, the following four conditions are required.

- ① **Good compression.** ② **Adequate "glow" at glowplug.** ③ **Correct mixture.**
 ④ **Sufficient electric starter rotating speed.**

If the engine fails to start, or does not keep running after being started, check symptoms against the following chart and take necessary corrective action.

Note: The most common causes of trouble are marked with three asterisks, the less common problems with one or two asterisks.

Symptom	Factor	Cause	Corrective action
Engine fails to fire.	①	★ Sluggish rotation	Recharge the electric starter battery.
		★★ Glowplug battery discharged.	Recharge lead-acid cell or replace dry battery. (Note: An unused, or almost unused, dry battery may sometimes be of insufficient capacity if it is "old stock".)
	②	★ Glowplug element is burned out	Replace glowplug. Check that applied voltage is not too high.
		★ Something wrong with battery leads.	Check glowplug heating using other leads.
		★★ Engine "flooded" due to excessive priming.	Close needle-valve fully and remove glowplug, then flip propeller to pump out excess fuel. (Invert engine, if possible, while pumping out excess). Re-start engine. (Priming is not necessary at this time.)
	③	★ Insufficient priming.	Repeat priming procedure referring to ⑦ Priming.

Symptom	Factor	Cause	Corrective action
Engine fires intermittently but does not run.	②—★★	Incorrect heating of glowplug.	· · · · · Voltage too high or too low. Re-check and readjust referring to "BEFORE STARTING" paragraph 4.
	③—★★	Over priming.	· · · · · Continue flipping propeller. If engine does not start after more than 10 flips, disconnect battery from glowplug and leave for a few minutes, then re-energize plug and flip prop again. If engine still does not start, remove glowplug and pump out excess fuel by flipping prop quickly.
	①—★	Sluggish rotation.	· · · · · Then re-start. (Priming is not necessary.) Recharge the electric starter battery.
Engine fires once or twice, then fails to fire.	②—★★	Glowplug battery discharged.	· · · · · Recharge lead-acid cell or replace dry battery. (Note: An unused, or almost unused, dry battery may sometimes be of insufficient capacity if it is "old stock".)
	③—★★	Insufficient priming.	· · · · · Repeat priming procedure referring to ⑦ Priming.
Engine starts but revolutions decrease and engine eventually stops.	③—★★★	Mixture too rich.	· · · · · Close needle-valve half turn (180°) and wait for several minutes then re-start.(Priming is not necessary.)
Engine starts, then revolutions increase and engine cuts out.	③—★	Fuel not reaching the engine.	· · · · · Make sure that tank is filled with fuel. Check that there is not something wrong with fuel tubing (kinked or split). Check that carburettor is not clogged with dirt.
Engine stops when battery leads are disconnected after starting.	③—★★	Mixture too rich.	· · · · · Close the needle-valve a little.
	②—★	Mismatch of glow plug and fuel.	· · · Change fuel or glowplug.

VALVE ADJUSTING

ALL O.S. four-stroke engines have their valve(tappet) clearances correctly set before they leave the factory. However, if, after many hours of running time have been logged, a loss of power is detected, or if the engine has to be disassembled or repaired as a result of an accident, valve clearances should be checked and readjusted, as necessary an O.S. Valve Adjusting Tool Kit is available as an optional accessory.

The kit comes in a plastic case and includes:
(Code No.72200060)

- Feeler gauge 0.04mm
- Feeler gauge 0.1mm
- Hex. key 1.5mm
- Wrench 5mm

Note:

Valve clearances of all O.S. four-stroke-cycle engines must be checked and reset ONLY WHEN THE ENGINE IS COLD.

Procedure is as follows:

(I)

- 1.Remove the cover from the rocker-box on top of the cylinderhead, using the correct size Allen hex key.
- 2.Turn the propeller counter-clockwise until compression is first felt, then turn it futher quarter turn. At this point, both valves should be closed. (If the prop driver ('drive hub') of your engine is engraved with a letter 'T', this mark should now be at the top.)
- 3.The standard valve clearance, on both inlet and exhaust valves, is between 0.04mm and 0.10mm(0.0015-0.004 inch), measured between valve stem and rocker arm. Use the 0.04mm and 0.10mm feeler gauges to check clearances.
(See Fig.1.)

Note:

If the gap is found to be less than 0.04mm, it is not necessary to readjust the clearance if the engine has good compression and starts easily.

Equally, if the gap exceeds 0.10mm but is not more than 0.14mm (i.e. the thickness of both feeler gauges inserted together), it is not necessary to readjust the clearance if the engine runs satisfactorily.

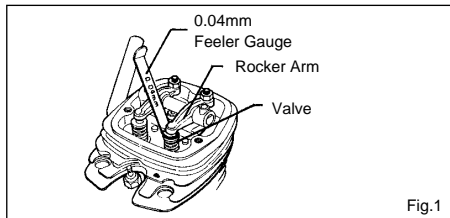

(II) If a clearance is found to be outside either of these limits, it should be reset as follows.

1. Carefully loosen the locknut on rocker-arm 1/4-1/2 turn with 5mm wrench. (Fig.2.)

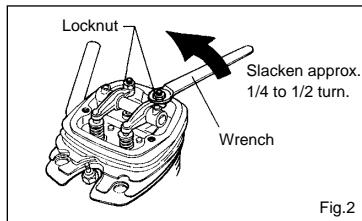

2. Turn adjusting-screw approx. 1/2 turn counter-clockwise to open gap, using appropriate tool -i.e. Allen hex key. (Fig.3.)

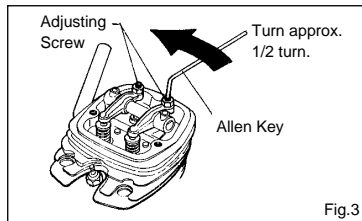

3. Insert 0.04mm feeler gauge between valve stem and rocker-arm and gently turn adjusting screw clockwise until it stops.(Fig.4.)

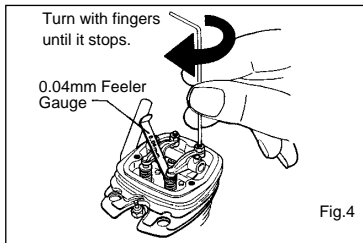

4. Re-tighten locknut while holding adjusting screw stationary. (Fig.5.)

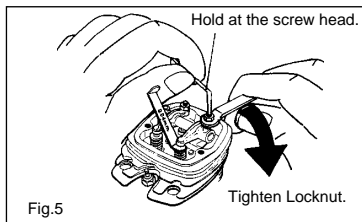

5. Remove 0.04mm feeler, rotate prop through two revolutions and recheck gap.
- 6.If clearance is correct, loosen the locknut on the other rocker-arm and repeat steps 1 to 5 above. Finally, replace rocker box cover.

Remember:

Excessive valve clearance will cause loss of power, due to valve (s) not opening sufficiently. On the other hand, a total loss of clearance may cause difficult starting due to valves not closing properly, resulting in loss of compression.

CARE AND MAINTENANCE

To ensure that you obtain long life and peak performance from your engine, observe the following.

1. Avoid running the engine under dusty conditions.
If necessary, lay a sheet of plywood or hard-board in front and under the nose of the model when starting the engine.
2. Foreign matter in the fuel can cause the carburettor jet to be partially clogged.

Therefore:

- rinse out the fuel tank with methanol or fuel before installing it.
- Install a fuel filter in the fuel line between tank and carburettor.
- Install a fuel filter in the outlet of your squeeze bottle, or to the pump inlet if you use a manual or electric pump.
- do not leave your fuel container open needlessly.
- check filters periodically and clean them when necessary.

3. Do not leave raw fuel in the engine at the conclusion of a flying session: it may cause corrosion. The best practice is to disconnect the fuel line from the carburettor while the engine is running. Remaining fuel in the tank should also be drained off.
4. Clean the exterior of the engine with a clean cotton cloth. If this is not done, oil and dirt will burn onto the outside of the engine each time it is run and the engine will soon become blackened.
5. If the engine is not in use for a while (more than two months) remove the glowplug and rinse out the interior with kerosene (not gasoline), by rotating the crankshaft. Shake out residue, then inject light machine-oil through the plug hole and carburettor intake, again rotating the shaft to distribute the protective oil to all working parts. Gasoline, thinner, kerosene and light machine oil cause swelling and deterioration of plastic parts, "O" rings and fuel tubing. Use methanol for cleaning these engines.
6. Avoid unnecessary dismantling of your engine.

THREE VIEW DRAWING FS-26S/FS-40S

FS-26S Specification

■ Displacement	4.41 cc (0.269 cu.in.)
■ Bore	18.5mm (0.728 in.)
■ Stroke	16.4mm (0.648 in.)
■ Practical R.P.M.	2,200~12,000 r.p.m.
■ Power output	0.41 bhp / 11,000 r.p.m.
■ Weight	268g (9.45 oz.)

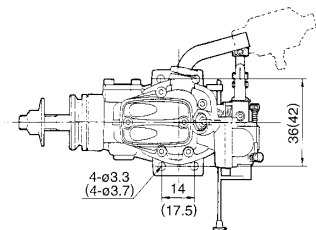

FS-40S Specification

■ Displacement	6.49 cc (0.396 cu.in.)
■ Bore	21.2mm (0.835 in.)
■ Stroke	18.4mm (0.724 in.)
■ Practical R.P.M.	2,200~12,000 r.p.m.
■ Power output	0.65 bhp / 12,000 r.p.m.
■ Weight	355g (12.5 oz.)

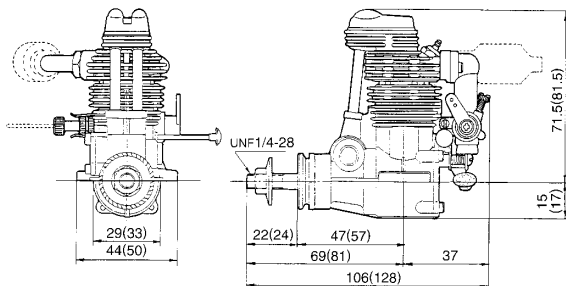

※ ()-FS-40S

Dimension(mm)

FS-26S ENGINE EXPLODED VIEW

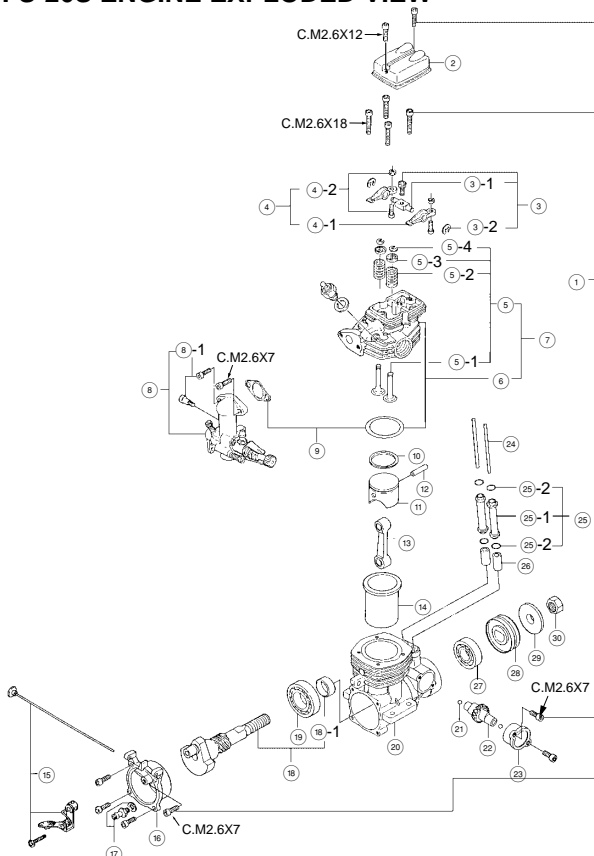

* Type of screw

C...Cap Screw B...Binding Head Screw M...Oval Fillister-Head Screw
 F...Flat Head Screw N...Round Head Screw S...Set Screw

FS-26S PARTS LIST

No.	Code No.	Description
①	4 4113 000	Screw Set
②	4 5704 200	Rocker Cover
③	4 5761 400	Rocker Support Assembly
③-1	4 5761 410	Rocker Support
③-2	4 5761 600	Rocker Arm Retainer (2pcs.)
④	4 5761 000	Rocker Arm Assembly (1pair)
④-1	4 5761 100	Rocker Arm (1pc.)
④-2	4 5761 200	Tappet Adjusting Screw
⑤	4 5760 010	Valve Assembly (1pair)
⑤-1	4 5760 110	Intake Valve (1pc.)
⑤-2	4 5760 200	Valve Spring (1pc.)
⑤-3	4 5060 309	Valve Spring Seat (1pc.)
⑤-4	4 6160 400	Valve Spring Retainer (2ps.)
⑥	4 4104 100	Cylinder Head(W/Gasket)
⑦	4 4104 010	Cylinder Head (W/Gasket and Valve Assembly)
⑧	4 5281 010	Carburetor Complete
⑧-1	4 5281 700	Carburetor Retaining Screw (2pcs.)
⑨	2 2714 100	Gasket Set
⑩	4 4103 400	Piston Ring
⑪	4 4103 200	Piston
⑫	2 2706 000	Piston Pin
⑬	4 5705 000	Connecting Rod
⑭	4 4103 100	Cylinder Liner
⑮	4 5784 000	Choke Valve Assembly
⑯	4 5707 000	Cover Plate
⑰	4 5771 000	Breather Nipple
⑱	4 4102 000	Crankshaft
⑱-1	4 5702 100	Crankshaft Spacer
⑲	2 2630 002	Crankshaft Ball Bearing (Rear)
⑳	4 4101 000	Crankcase
㉑	4 5762 100	Thrust Ball(2pc.)
㉒	4 5762 000	Camshaft
㉓	4 5701 100	Cam Cover
㉔	4 4166 000	Push Rod (2pcs.)
㉕	4 4166 100	Push Rod Cover Assembly (2pcs.)
㉕-1	4 4166 110	Push Rod Cover (1pcs.)
㉕-2	2 4881 824	Push Rod Cover "O"Ring (2pcs.)
㉖	4 5264 000	Cam Follower (2pcs.)
㉗	4 5231 000	Crankshaft Ball Bearing (Front)
㉘	4 5708 000	Drive Hub
㉙	2 3009 006	Propeller Washer
㉚	2 3210 007	Propellern Nut
	4 4125 000	Silencer Assembly
	4 5769 000	Exhaust Pipe Assembly
	4 5769 100	Exhaust Pipe
	4 5769 200	Exhaust Lock Nut
	7 1615 009	Glow Plug Type F

Specifications are subject to alteration for improvement without notice.

FS-40S ENGINE EXPLODED VIEW

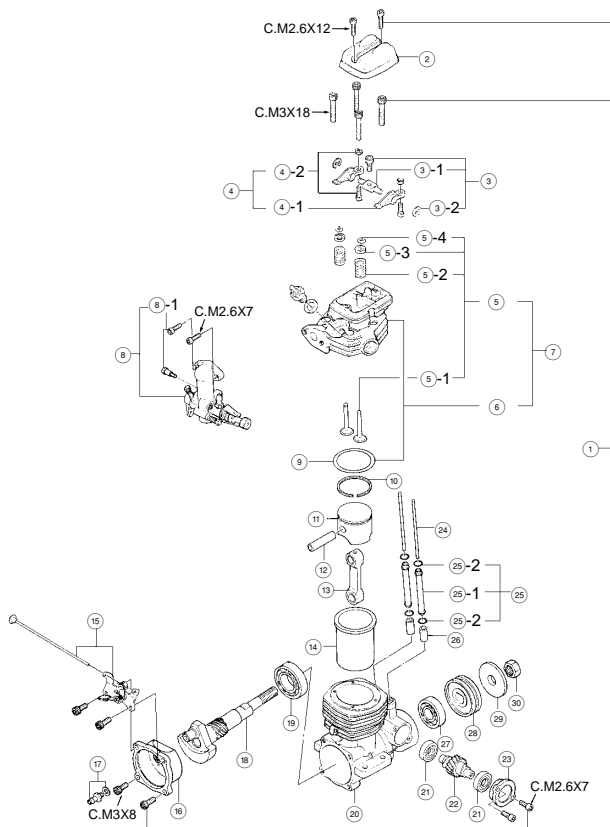

* Type of screw

C...Cap Screw B...Binding Head Screw M...Oval Fillister-Head Screw
 F...Flat Head Screw N...Round Head Screw S...Set Screw

FS-40S PARTS LIST

No.	Code No.	Description
①	4 5213 010	Screw Set
②	4 5204 210	Rocker Cover
③	4 5261 400	Rocker Support Assembly
③-1	4 5261 410	Rocker Support
③-2	4 5761 600	Rocker Arm Retainer (2pcs.)
④	4 5261 010	Rocker Arm Assembly (1pair)
④-1	4 5261 110	Rocker Arm (1pc.)
④-2	4 5761 200	Tappet Adjusting Screw
⑤	4 5260 010	Valve Assembly (1pair)
⑤-1	4 5260 110	Intake Valve (1pc.)
⑤-2	4 5060 205	Valve Spring (1pc.)
⑤-3	4 5060 309	Valve Spring Seat (1pc.)
⑤-4	4 5060 402	Valve Spring Retainer (2pcs.)
⑥	4 5204 110	Cylinder Head(W/Gasket)
⑦	4 5204 010	Cylinder Head (W/Gasket and Valve Assembly)
⑧	4 5281 020	Carburetor Complete
⑧-1	4 5281 700	Carburetor Retaining Screw (2pcs.)
⑨	4 5214 100	Head Gasket
⑩	2 4203 410	Piston Ring
⑪	4 5203 210	Piston
⑫	2 3356 000	Piston Pin
⑬	4 5205 000	Connecting Rod
⑭	4 5203 100	Cylinder Liner
⑮	4 5284 000	Choke Valve Assembly
⑯	4 5207 000	Cover Plate
⑰	4 5771 000	Breather Nipple
⑱	4 5202 010	Crankshaft
⑲	2 2630 002	Crankshaft Ball Bearing (Rear)
⑳	4 5201 040	Crankcase
㉑	4 5231 100	Camshaft Bearing
㉒	4 5262 010	Camshaft
㉓	4 5201 110	Cam Cover
㉔	4 5266 010	Push Rod (2pcs.)
㉕	4 5266 102	Push Rod Cover Assembly (2pcs.)
㉕-1	4 5266 112	Push Rod Cover (1pcs.)
㉕-2	2 4881 824	Push Rod Cover "O"Ring (2pcs.)
㉖	4 5264 000	Cam Follower (2pcs.)
㉗	4 5231 000	Crankshaft Ball Bearing (Front)
㉘	4 5208 010	Drive Hub
㉙	2 3209 003	Propeller Washer
㉚	2 3210 007	Propellern Nut
	4 5225 000	Silencer Assembly
	4 5225 010	Silencer
	4 5226 000	Exhaust Header Pipe
	7 1615 009	Glow Plug Type F

Specifications are subject to alteration for improvement without notice.

CARBURETTOR EXPLODED VIEW & PARTS LIST

TYPE FS-26S/FS-40S

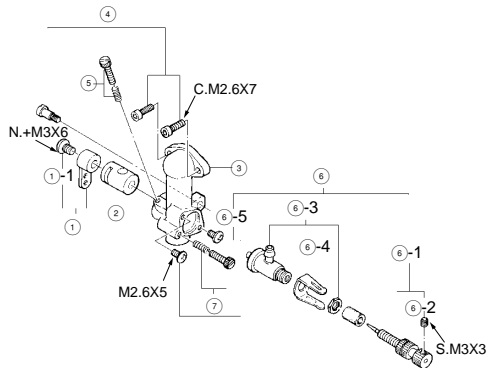

* Type of screw

C...Cap Screw M...Oval Fillister-head Screw F...Flat Head Screw

N...Round Head Screw S...Set Screw

TYPE FS-26S

No.	Code No.	Description
①	22081408	Throttle Lever Assembly
①-1	22081313	Throttle Lever Retaining Screw
②	45281200	Carburetor Rotor
③	45281100	Carburetor Body
④	45281700	Carburetor Retaining Screw(3pcs.)
⑤	22081811	Throttle Stop Screw
⑥	45281910	Needle-valve Assembly
⑥-1	45781970	Needle
⑥-2	26381501	Set-screw
⑥-3	45283960	Nozzle Assembly
⑥-4	23011308	Ratchet Spring
⑥-5	45281920	Nozzle Retaining Screw(2pcs.)
⑦	22081820	Air-bleed Screw

TYPE FS-40S

No.	Code No.	Description
①	22081408	Throttle Lever Assembly
①-1	22081313	Throttle Lever Retaining Screw
②	45281120	Carburetor Rotor
③	45281110	Carburetor Body
④	45281700	Carburetor Retaining Screw(3pcs.)
⑤	22081811	Throttle Stop Screw
⑥	45281910	Needle-valve Assembly
⑥-1	45781970	Needle
⑥-2	26381501	Set-screw
⑥-3	45283960	Nozzle Assembly
⑥-4	23011308	Ratchet Spring
⑥-5	45281920	Nozzle Retaining Screw(2pcs.)
⑦	22081820	Air-bleed Screw

Specifications are subject to alteration for improvement without notice.

PARTS & ACCESSORIES

- **O.S.Glow Plug**
TYPE F
(71615009)



- **Radial Mount Set**
For 26S (71908300)
For 40S (71906000)

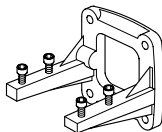

- **Propeller Locknut Set**
For 40S(45810100)



- **Valve Adjusting Tool Kit**
(72200060)



- **Spinner Nut**
For 40S 1/4"-28 (23024008)



- **Flexible Exhaust Pipes**
For 40S
1010A (72108300)
1010B (72108310)



- **NON-BUBBLE Weight**
(71531000)



- **Super Filter (L)**
(72403050)



- **Long Socket Wrench With Plug Grip**
(71521000)

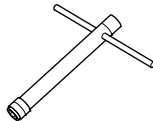

MEMO



O.S. ENGINES MFG.CO.,LTD.

6-15 3-Chome Imagawa Higashisumiyoshi-ku
Osaka 546-0003, Japan TEL. (06) 6702-0225

FAX. (06) 6704-2722

URL : <http://www.os-engines.co.jp>

© Copyright 2000 by O.S.Engines Mfg. Co., Ltd. All rights reserved. Printed in Japan.

110101