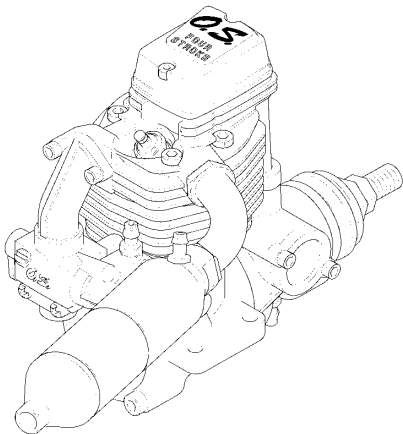

O.S. ENGINE

O.S. FS-52S

**FOUR CYCLE ENGINE
OWNER'S INSTRUCTION MANUAL**

It is of vital importance, before attempting to operate your engine, to read the general **'SAFETY INSTRUCTIONS AND WARNINGS'** section on pages 2-6 of this booklet and to strictly adhere to the advice contained therein.

- Also, please study the entire contents of this instruction manual, so as to familiarize yourself with the controls and other features of the engine.
- Keep these instructions in a safe place so that you may readily refer to them whenever necessary.
- It is suggested that any instructions supplied with the aircraft, radio control equipment, etc., are accessible for checking at the same time.



CONTENTS

SAFETY INSTRUCTIONS AND WARNINGS ----- 2~6 ABOUT YOUR O.S. ENGINE	RUNNING -IN ----- 15~16
INTRODUCTION,BASIC ENGINE PARTS ----- 7	IDLING MIXTURE ADJUSTMENT ----- 16~17
INSTALLATION ----- 8	VALVE ADJUSTING ----- 17~20
EXHAUST HEADER PIPE AND SILENCER, THROTTLE LINKAGE, NEEDLE-VALVE EXTENSION ----- 9	CARE AND MAINTENANCE ----- 20~21
PROPELLERS, FUEL ----- 10	ENGINE EXPLODED VIEW ----- 22
GLOWPLUG ----- 11	ENGINE PARTS LIST ----- 23
FUEL AND PRESSURE LINES, PROPELLER AND SPINNER ATTACHMENT ----- 12	CARBURETTOR EXPLODED VIEW & PARTS LIST ----- 24
TYPE 40N CARBURETTOR, CONTROL LOCATIONS ----- 13	GENUINE PARTS & ACCESSORIES ----- 25
STARTING ----- 14~15	THREE VIEW DRAWING ----- 26

SAFETY INSTRUCTIONS AND WARNINGS ABOUT YOUR O.S. ENGINE

Remember that your engine is not a "toy", but a highly efficient internal-combustion machine whose power is capable of harming you, or others, if it is misused.

As owner, you, alone, are responsible for the safe operation of your engine, so act with discretion and care at all times.

If at some future date, your O.S. engine is acquired by another person, we would respectfully request that these instructions are also passed on to its new owner.

- The advice which follows is grouped under two headings according to the degree of damage or danger which might arise through misuse or neglect.



WARNINGS

These cover events which might involve serious (in extreme circumstances, even fatal) injury.



NOTES

These cover the many other possibilities, generally less obvious sources of danger, but which, under certain circumstances, may also cause damage or injury.



WARNINGS

- Never touch, or allow any object to come into contact with, the rotating propeller and do not crouch over the engine when it is running.



- A weakened or loose propeller may disintegrate or be thrown off and, since propeller tip speeds with powerful engines may exceed 600 feet(180 metres) per second, it will be understood that such a failure could result in serious injury, (see 'NOTES' section relating to propeller safety).

- Model engine fuel is poisonous. Do not allow it to come into contact with the eyes or mouth. Always store it in a clearly marked container and out of the reach of children.



- Model engine fuel is also highly flammable. Keep it away from open flame, excessive heat, sources of sparks, or anything else which might ignite it. Do not smoke or allow anyone else to smoke, near to it.



- Never operate your engine in an enclosed space. Model engines, like automobile engines, exhaust deadly carbon-monoxide. Run your engine only in an open area.

- Model engines generate considerable heat. Do not touch any part of your engine until it has cooled. Contact with the muffler (silencer), cylinder head or exhaust header pipe, in particular, may result in a serious burn.





NOTES

- This engine was designed for model aircraft. Do not attempt to use it for any other purpose.
- Mount the engine in your model securely, following the manufacturers' recommendations, using appropriate screws and lock-nuts.
- Be sure to use the silencer (muffler) supplied with the engine. Frequent exposure to an open exhaust may eventually impair your hearing. Such noise is also likely to cause annoyance to others over a wide area.
- If you remove the glowplug from the engine and check its condition by connecting the battery leads to it, do not hold the plug with bare fingers. Use an appropriate tool or a folded piece of cloth.
- Fit a top-quality propeller of the diameter and pitch specified for the engine and aircraft. Locate the propeller on the shaft so that the curved face of the blades faces forward-i.e. in the direction of flight. Firmly tighten the propeller nut, using the correct size wrench.



NOTES

- Always check the tightness of the propeller nut and retighten it, if necessary, before restarting the engine, particularly in the case of four-stroke-cycle engines. If a safety locknut assembly is provided with your engine, always use it. This will prevent the propeller from flying off in the event of a "backfire", even if it loosens.
- If you fit a spinner, make sure that it is a precision made product and that the slots for the propeller blades do not cut into the blade roots and weaken them.
- Preferably, use an electric starter. The wearing of safety glasses is also strongly recommended.
- Discard any propeller which has become split, cracked, nicked or otherwise rendered unsafe. Never attempt to repair such a propeller: destroy it. Do not modify a propeller in any way, unless you are highly experienced in tuning propellers for specialized competition work such as pylon-racing.
- Take care that the glow plug clip or battery leads do not come into contact with the propeller. Also check the linkage to the throttle arm. A disconnected linkage could also foul the propeller.
- After starting the engine, carry out any needle-valve readjustments from a safe position behind the rotating propeller. Stop the engine before attempting to make other adjustments to the carburettor.



NOTES

- Adjust the throttle linkage so that the engine stops when the throttle stick and trim lever on the transmitter are fully retarded. Alternatively, the engine may be stopped by cutting off the fuel supply. Never try to stop the engine physically.
- Take care that loose clothing (ties, shirt sleeves, scarves, etc.) do not come into contact with the propeller. Do not carry loose objects (such as pencils, screwdrivers, etc.) in a shirt pocket from where they could fall through the propeller arc.
- Do not start your engine in an area containing loose gravel or sand. The propeller may throw such material in your face and eyes and cause injury.
- For their safety, keep all onlookers (especially small children) well back (at least 20 feet or 6 meters) when preparing your model for flight. If you have to carry the model to the take-off point with the engine running, be especially cautious. Keep the propeller pointed away from you and walk well clear of spectators.
- Warning! Immediately after a glowplug-ignition engine has been run and is still warm, conditions sometimes exist whereby it is just possible for the engine to abruptly restart if the propeller is casually flipped over compression WITHOUT the glowplug battery being reconnected. Remember this if you wish to avoid the risk of a painfully rapped knuckle!

INTRODUCTION

Having pioneered the development of four-stroke cycle model aircraft engines in 1976, O.S. has maintained a continuing program of technological advancement, examples of which, would include the line of beautiful multi-cylinder engines, with many new engine designs continually under development. One of the latter is this new FS-52S model. Closely resembling the FS-48S externally, the FS-52S combines increased performance and improved durability at virtually no increase in overall dimensions or weight.

INSTALLING THE GLOWPLUG

Fit washer to glowplug and insert carefully into cylinder-head, making sure that it is not cross-threaded before tightening firmly.

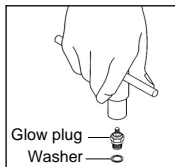

BASIC ENGINE PARTS

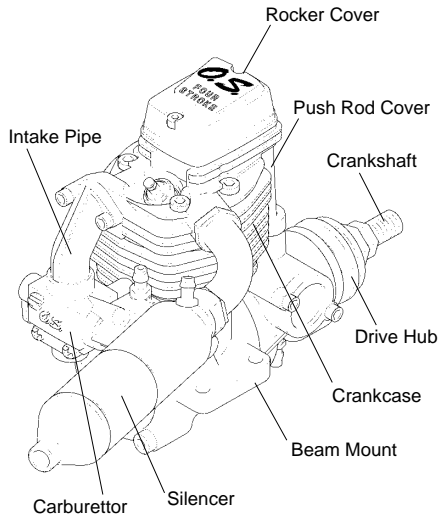

INSTALLATION

Installation in the model

A typical method of beam mounting is shown below, left.

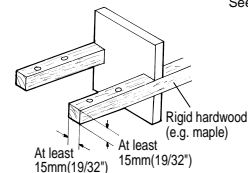

O.S. radial motor mount
(Available as an optional extra part.
See parts list)

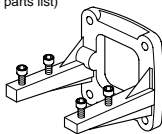

Make sure that the mounting beams are parallel and that their top surfaces are in the same plane.

CORRECT

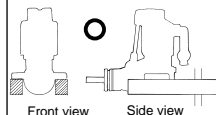

Front view
Side view
Top surfaces are in the same plane.

INCORRECT

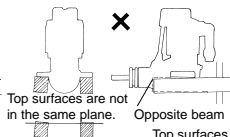

Top surfaces are not in the same plane.
Opposite beam
Top surfaces are not in the same plane.
Re-align the surfaces as necessary
Engine does not rest firmly.

How to fasten the mounting screws.

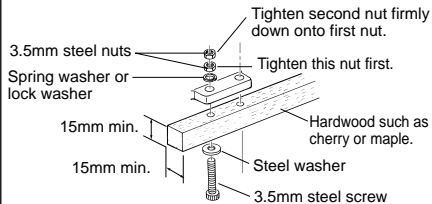

Hardwood mounting beams

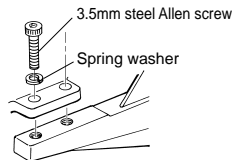

O.S. radial motor mount (cast aluminum)

EXHAUST HEADER PIPE & SILENCER

Fit these in the following sequence.

Screw the header pipe into the cylinder head until it bottoms, then unscrew sufficiently to achieve the desired exhaust angle and tighten the locknut securely with a 14mm wrench. Screw the silencer onto the outer end of the header pipe and tighten the second locknut. The application of a heatproof silicone sealant to the threads of the exhaust system is recommended to reduce the risk of joints loosening and the leakage of exhaust gases and oil residue.

Reminder:

Model engines generate considerable heat and contact with the header pipe or silencer may result in a serious burn. If you need to tighten the silencer joints, which may loosen when they are hot, use a thick folded cloth for protection.

THROTTLE LINKAGE

Before connecting the throttle to the servo, make sure that the throttle arm and linkage safely clear any adjacent part of the airframe structure, etc., as the throttle is opened and closed.

Connect the linkage so that the throttle is fully closed when the transmitter throttle stick and its trim lever are at their lowest settings and fully open when the throttle stick is in its fully-open position..

Carefully align the appropriate holes in the throttle arm and servo horn so that they move symmetrically and smoothly through their full travel.

NEEDLE-VALVE EXTENSION

The needle-valve supplied with this engine is designed to accept an extension so that, when the engine is enclosed in a cowling, the needle-valve may be adjusted from the outside.

An L-shaped rod, of appropriate length, may be inserted in the needle-valve knob center hole and secured by tightening the set-screw with a 1.5mm Allen key.

PROPELLERS

The choice of propeller depends on the design and weight of the aircraft and on the type of flying in which you will be engaged. Determine the best size and type after practical experimentation. As a starting point, refer to the props listed in the accompanying table. Slightly larger, or even slightly smaller, props than those shown in the table may be used, but remember that propeller noise will increase if the blade tip velocity is increased or a larger-diameter / smaller-pitch prop used.

Type	Size (DxP)
Stunt planes	10x9-10, 10.5x8-9, 11x7-8
Scale models	11x7-8, 12x6, 12.5x6

Warning:

Make sure that the propeller is well balanced. An unbalanced propeller and / or spinner can cause serious vibration which may weaken parts of the airframe or affect the safety of the radio-control system.

FUEL

The FS-52S is should be operated on a methanol based fuel containing not less than 18% castor-oil, or a top quality synthetic lubricant (or a mixture of both), plus a small percentage (5-15%) of nitromethane for improved flexibility and power. The carburettor is adjusted at the factory for a fuel containing 20% lubricant and 10% nitromethane. Some commercial fuels also contain color additives as an aid to fuel level visibility. In some cases, these additives have indicated slightly negative effects on performance. We would suggest that you use such fuels only if you are satisfied that they do not adversely affect running qualities when compared with familiar standard fuels. When changing to a fuel brand or formula that is different from the one to which you are accustomed, it is a wise precaution to temporarily revert to in-flight running-in procedures, until you are sure that the engine is running entirely satisfactorily.

Reminder!

Model engine fuel is poisonous. Do not allow it to come into contact with the eyes or mouth. Always store it in a clearly marked container and out of the reach of children.





Model engine fuel is also highly flammable. Keep it away from open flame, excessive heat, sources of sparks, or anything else which might ignite it.

GLOWPLUG

The FS-52S is supplied with an O.S. Type F glowplug, specially designed for O.S. four-stroke engines.

The role of the glowplug

With a glowplug engine, ignition is initiated by the application of a 1.5-volt power source. When the battery is disconnected, the heat retained within the combustion chamber remains sufficient to keep the plug filament glowing, thereby continuing to keep the engine running. Ignition timing is 'automatic' : under reduced load, allowing higher rpm, the plug becomes hotter and, appropriately, fires the fuel/air charge earlier; conversely, at reduced rpm, the plug become cooler and ignition is retarded.

Glowplug life

Particularly in the case of very high performance engines, glowplugs must be regarded as expendable. However, plug life can be extended and engine performance maintained by careful use, i.e.:

- Install a plug suitable for the engine.
- Use fuel containing a moderate percentage of nitromethane unless more is essential for racing events.
- Do not run the engine too lean and do not leave the battery connected while adjusting the needle.

When to replace the glowplug

Apart from when actually burned out, a plug may need to be replaced because it no longer delivers its best performance, such as when:

- Filament surface has roughened and turned white.
- Filament coil has become distorted.
- Foreign matter has adhered to filament or plug body has corroded.
- Engine tends to cut out when idling.
- Starting qualities deteriorate.

FUEL AND PRESSURE LINES

Connect suitable lengths of silicone tubing, as illustrated, after installing the engine.

Attention to tank height

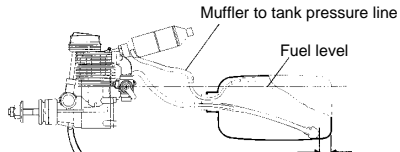

Locate the fuel tank so the top of the tank is 5-10mm (1/4-3/8") above the level of the needle-valve.

Note: When cutting silicone tubing--

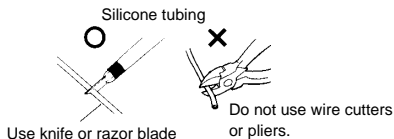

*If you should need to clean out silicone tubes, use methanol or glow-fuel, not gasoline or kerosene.

PROPELLER & SPINNER ATTACHMENT

There is a risk, particularly with powerful four-stroke engines, of the propeller flying off if the prop nut loosens due to detonation ("knocking") in the combustion chamber when the engine is operated too lean, or under an excessively heavy load.

Obviously, this can be very hazardous. To eliminate such dangers, the O.S. Safety Locknut Assembly was devised. Fit this as follows:

1. Fit the prop to the engine shaft, followed by the retaining washer and prop nut and tighten firmly with a 14mm wrench.
2. Add the special tapered and slotted locknut and secure with a 12mm wrench while holding the prop nut with the 14mm wrench.

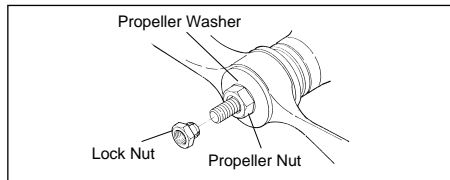

TYPE 40N CARBURETTOR

Two adjustable controls are provided on this carburettor.

They are as follows:

- **The Needle Valve**

This is used to establish the fuel/air mixture strength required for full power when the throttle is fully open.

- **The Idle Mixture Control Screw**

This is used to establish the mixture strength required for steady idling and a smooth transition to medium speeds. (The varying mixture strength required between part-throttle and full-throttle running is automatically adjusted by coupled movement of the throttle.)

The sequence in which these controls are adjusted is explained in the succeeding sections, under Starting, Running-in and Idling Adjustment.

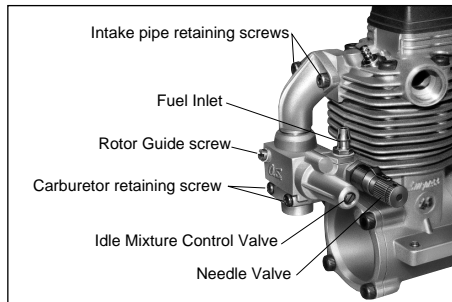

CONTROL LOCATIONS

The needle-valve and throttle locations, left and right, are interchangeable by reversing the carburettor. This can be done as follows. Carefully free the carburettor by removing the two screws that join the carburettor body to the crankcase cover-plate and by loosening the two screws securing the intake pipe flange to the cylinderhead. Gently rotate the carburettor, 180 degrees, on the intake pipe, taking care not to damage the O-ring then Replace the screws.

STARTING

The FS-52S is not fitted with a manual choke control, since it has been designed for use with an electric starter only.

A high-torque electric starter not only makes starting the engine much easier, it dispenses with the need for a choke valve by rotating the engine fast enough to cause the fuel pump to prime the cylinder automatically.

1. Check that the current to the glowplug is switched off.
2. Check that the polarity of the starter battery leads rotates the engine counter-clockwise when viewed from the front.
3. Open the needle-valve 2-2.5 turns from the fully closed position and temporarily set the throttle in the fully open position.
4. Apply the starter and press the starter switch for 5-6 seconds, or until fuel is seen to emerge from the exhaust outlet, indicating that the cylinder is now primed.

5. Close the throttle-arm to within 15-20° of the fully closed position and slowly turn the prop "backwards" (clockwise) by hand approximately 1.5 turns until it is arrested by compression. This is to enable the kinetic energy of the prop to subsequently assist the starter through the compression stroke to start the engine.

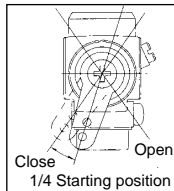

6. Energize the glowplug and apply the starter. If the starter fails to rotate the engine completely, this may be due to the cylinder being over-primed, or to the starter battery being insufficiently charged.
7. Check these conditions and, instead of pressing the starter button after applying the starter, have the starter spinning before applying it to the engine, to give it a "running start".
When the engine starts, slowly open the throttle, leaving the needle-valve at its rich starting setting to promote cool running conditions.
However, if the engine slows down because the mixture is excessively rich, the needle-valve may be closed a little to speed it up until it runs evenly.

8. Now disconnect current to the glowplug and gradually close the needle-valve so that the rpm increases. Make adjustments to the needle in small steps. Abrupt changes at this stage are likely to cause the engine to stall. Restart the engine by simply applying the starter with the glowplug re-energized and the throttle at its starting setting.

RUNNING-IN ("Breaking-in")

For long life expectancy and maximum performance every engine requires a break-in period under controlled conditions in order to avoid over-heating that could damage the internal parts while they are being smoothed and polished together.

With some engines, this can require a tediously protracted period of bench running, but, as O.S. engines are manufactured to fine tolerances and from the finest quality materials, a relatively brief running-in period is sufficient and can be completed with the engine installed in the aircraft.

The recommended procedure is as follows :

1. Start and adjust the engine as detailed in the starting instructions.
2. Now open the throttle fully and run the engine for no more than 5 seconds with the needle-valve tuned to produce near maximum r.p.m., then, immediately, slow the engine down again by opening the needle-valve approximately 1/2 turn. The rich mixture, will cool the engine, at the same time providing ample lubrication.
3. Allow the engine to run like this for about 10 seconds, then close the needle-valve again to speed it up to near maximum speed for another 5 seconds.
4. Repeat this process, alternately running the engine fast and slow by means of the needle-valve, while keeping the throttle fully open, then begin to extend the short periods of high-speed operation until two full tanks of fuel have been consumed.

WARNING:

When ground running the engine, avoid dusty or sandy locations. If dust or grit is drawn into the engine, this can have a damaging effect, drastically shortening engine life in a matter of minutes.

5. Following the initial running-in session, check for any looseness in the installation due to vibration, then allow the engine a period of moderately rich operation in flight.
6. For the first flight, have the needle-valve set on the rich side and adjust the throttle trim on the transmitter so that the engine does not stop when the throttle is closed to the idling setting.
7. With each successive flight, close the needle-valve very slightly until, at the end of about 10 flights, the needle is set for full power. Do not "over-lean" the mixture in an attempt to extract more power.

RUNNING-IN (continued)

8. If overheating should be suspected at any time during flight (i.e. if the engine begins to labor) reduce power by partially closing the throttle and land the aircraft and reset the needle valve for a richer setting.

Note:

Remember that, when the engine is not yet fully run-in, the carburettor cannot be expected to give its best response in flight. Abrupt operation of the throttle, for example, may cause the engine to stall.

Therefore, at this time ,the aircraft should, as far as is possible, be flown at an altitude sufficient to enable an emergency landing to be safely made if the engine stops.

9. Once the engine has demonstrated that it can be safely operated at full power, the carburettor can be adjusted for optimum throttle response, following the instructions given in the next section.

IDLING MIXTURE ADJUSTMENT

1. Start the engine, open the throttle fully and set the needle-valve slightly rich (30-45°) from the highest r.p.m. setting.
2. Close the throttle to the idling position. Allow the engine to idle for about 5 seconds, then reopen the throttle. The engine should accelerate smoothly back to full speed.
3. If, instead, the engine responds sluggishly and emits an excess of white smoke from the exhaust, the idling mixture is too rich. Turn the mixture control screw approx. 45° clockwise to lean the idling mixture.

4. On the other hand, if the engine hesitates before picking up speed or even ceases firing completely, the idling mixture is likely to be too lean. Turn the mixture control valve 90° counter-clockwise to substantially richen the mixture, then back again 45° clockwise.
5. In paragraphs 3 and 4 above, the 45° total movements are, of course, approximate. It will be necessary to fine-tune the mixture control screw 10-15° at a time to reach the best setting for optimum throttle response.
6. Continue re-checking the idling mixture setting until the engine responds smoothly and positively to operation of the throttle at all times.

Realignment of Mixture Control Screw

In the course of making readjustments, it is just possible that the mixture control screw may be inadvertently screwed in or out too far and thereby moved beyond its effective range.

Its basic position can be found by first rotating the Mixture Control Valve unit its slotted head is flush with the carburettor body. The valve is then screwed in exactly 1 turn to re-establish the original setting.

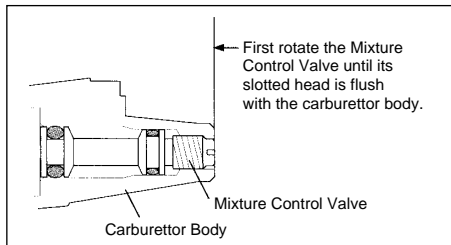

VALVE ADJUSTING

ALL O.S. four-stroke engines have their valve(tappet) clearances correctly set before they leave the factory. However, if, after many hours of running time have been logged, a loss of power is detected, or if the engine has to be disassembled or repaired as a result of an accident, valve clearances should be checked and readjusted, as necessary an O.S. Valve Adjusting Tool Kit is available as an optional accessory.

The kit comes in a plastic case and includes:
(Code No.72200060)

- Feeler gauge 0.04mm
- Feeler gauge 0.1mm
- Hex. key 1.5mm
- Wrench 5mm

Note:

Valve clearances of all O.S. four-stroke-cycle engines must be checked and reset ONLY WHEN THE ENGINE IS COLD.

Procedure is as follows:

(I)

- 1.Remove the cover from the rocker-box on top of the cylinderhead, using the correct size Allen hex key.
- 2.Turn the propeller counter-clockwise until compression is first felt, then turn it futher quarter turn. At this point, both valves should be closed. (If the prop driver ('drive hub') of your engine is engraved with a letter 'T', this mark should now be at the top.)

- 3.The standard valve clearance, on both inlet and exhaust valves, is between 0.04mm and 0.10mm(0.0015-0.004 inch), measured between valve stem and rocker arm. Use the 0.04mm and 0.10mm feeler gauges to check clearances.
(See Fig.1.)

Note:

If the gap is found to be less than 0.04mm, it is not necessary to readjust the clearance if the engine has good compression and starts easily.

Equally, if the gap exceeds 0.10mm but is not more than 0.14mm (i.e. the thickness of both feeler gauges inserted together), it is not necessary to readjust the clearance if the engine runs satisfactorily.

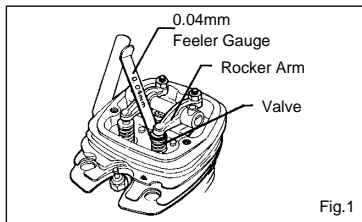
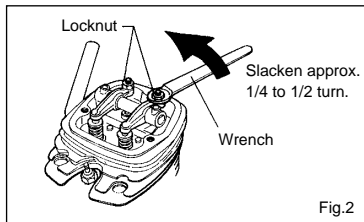

Fig.1

(II) If a clearance is found to be outside either of these limits, it should be reset as follows.

1. Carefully loosen the locknut on rocker-arm 1/4-1/2 turn with 5mm wrench. (Fig.2.)



2. Turn adjusting-screw approx. 1/2 turn counter-clockwise to open gap, using appropriate tool -i.e. Allen hex key. (Fig.3.)

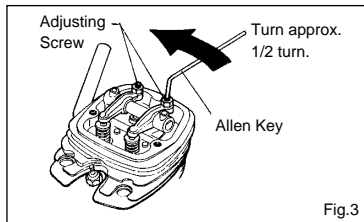

3. Insert 0.04mm feeler gauge between valve stem and rocker-arm and gently turn adjusting screw clockwise until it stops.(Fig.4.)

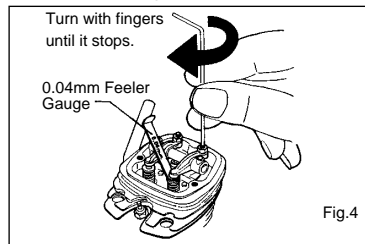

4. Re-tighten locknut while holding adjusting screw stationary. (Fig.5.)

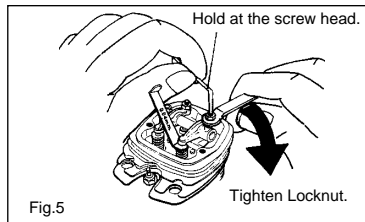

5. Remove 0.04mm feeler, rotate prop through two revolutions and recheck gap.
6. If clearance is correct, loosen the locknut on the other rocker-arm and repeat steps 1 to 5 above. Finally, replace rocker box cover.

Remember:

Excessive valve clearance will cause loss of power, due to valve (s) not opening sufficiently. On the other hand, a total loss of clearance may cause difficult starting due to valves not closing properly, resulting in loss of compression.

CARE AND MAINTENANCE

Please pay attention to the matters described below to ensure that your engine serves you well in regard to performance, reliability and long life.

As previously mentioned, it is vitally important to avoid operating the engine in conditions where dust, stirred up by the propeller will be ingested into the engine resulting in damage to the internal parts. Also, remember to keep your fuel container closed to prevent foreign matter from contaminating the fuel.

Do not forget to clean the fuel filters periodically and, from time to time, unscrew the complete needle-valve assembly from the carburettor and remove any foreign matter that has accumulated in this area. (See photo.) If these precautions are neglected, restriction of fuel flow may cause the engine to cut out, or the fuel/air mixture to become too lean, causing the engine to overheat. The use of modern high-performance alcohol based model engine fuels, while promoting cooler running, improved anti-detonation combustion and increased power, have the disadvantage in four-stroke engines, of a tendency to cause bottom end corrosion if not checked. This is because the acidic by-products of combustion, some of which contaminate the oil in the crankcase, are not, in a four-stroke, diluted and flushed out by the flow of fresh fuel mixture through the crankcase as in the case of a two-stroke engine. Such contamination (made worse if the fuel also contains a high proportion of power boosting nitromethane) can cause rusting of steel parts. As noted earlier, the FS-52S has its most vulnerable internal parts protected against such attack but, as a primary defence, users are advised, once again, to avoid running the engine on too lean a mixture and by making sure that the engine is flushed

of contaminants as much as possible.

Do not leave unused fuel in the engine at the conclusion of a day's flying. Accepted practice is to cut off the fuel supply while the engine is still running - at full throttle - then, to eliminate as much residue as possible rotate the engine for 5-10 seconds with the electric starter.

Finally, inject some after-run oil through the glowplug hole and turn the engine over several times by hand. When the engine is not to be used for some months (for example, as between flying seasons) a worthwhile precaution is to remove it from the airframe and, after washing off the exterior with alcohol (not gasoline or kerosene) to carefully remove the fuel pump, carburettor with intake pipe and all silicone tubing and put them safely aside.

Make sure that the engine is reasonably clean externally, then remove the glowplug and immerse the engine in a container of kerosene. Rotate the crankshaft while the engine is immersed. If foreign matter is visible in the kerosene, rinse the engine again in clean kerosene, shake off the excess and wipe it dry.

CARE & MAINTENANCE (continued)

The fuel pump assembly, carburettor/pressure-regulator and silicone tubing must be cleansed separately in methanol or glow fuel. On no account must they come into contact with kerosene.

Before completely reassembling the engine, make sure that no kerosene remains inside that could find its way into the pump unit, carburettor, etc. Inject, sparingly, after-run oils, rust inhibitors, etc. unless approved for silicone-rubber products.

An appropriate alternative here may be one of the high-quality synthetic lubricating oils.

Finally, seal the engine in a heavy polyethylene bag until required for future use.

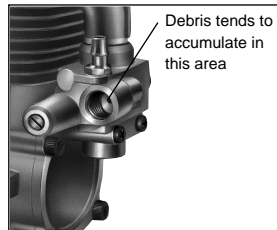

ENGINE EXPLODED VIEW

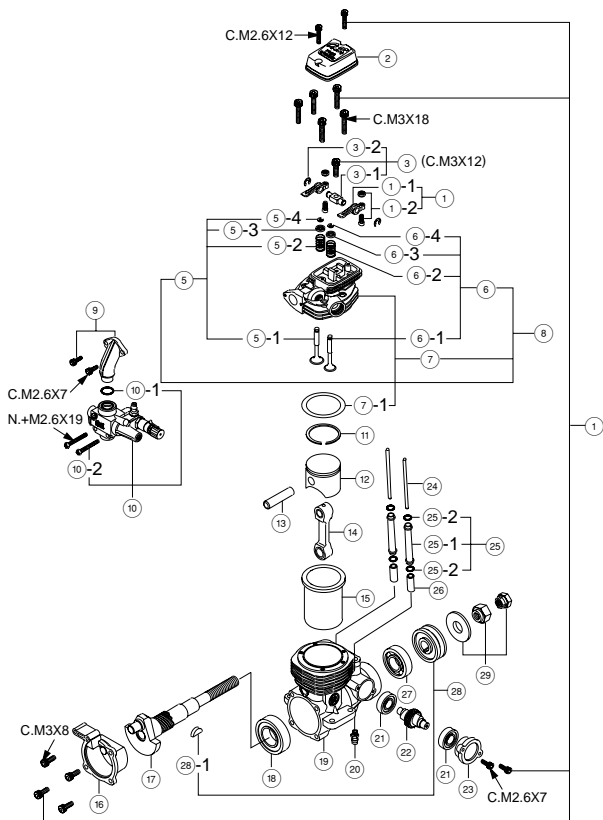

* Type of screw

C...Cap Screw B...Binding Head Screw M...Oval Fillister-Head Screw
 F...Flat Head Screw N...Round Head Screw S...Set Screw

PARTS LIST

No.	Code No.	Description
①	4 5813 000	Screw Set
②	4 4204 200	Rocker Cover
③	4 5261 400	Rocker Support Assembly
③-1	4 5261 410	Rocker Support
③-2	4 5761 600	Rocker Arm Retainer (2pcs.)
④	4 5261 010	Rocker Arm Assembly (1pair)
④-1	4 5261 110	Rocker Arm (1pc.)
④-2	4 5761 200	Tappet Adjusting Screw
⑤	4 4260 000	Intake Valve Assembly (1pair)
⑤-1	4 4260 100	Intake Valve (1pc.)
⑤-2	4 4260 200	Valve Spring (1pc.)
⑤-3	4 5060 309	Valve Spring Seat (1pc.)
⑤-4	4 6160 400	Valve Spring Retainer (2ps.)
⑥	4 4261 000	Exhaust Valve Assembly(1pair.)
⑥-1	4 4261 100	Exhaust Valve(1pc.)
⑥-2	4 4260 200	Valve Spring(1pc.)
⑥-3	4 5060 309	Valve Spring Seat(1pc.)
⑥-4	4 6160 400	Valve Spring Retainer(1pc.)
⑦	4 4204 100	Cylinder Head
⑦-1	4 5814 100	Cylinder Head Gasket
⑧	4 4204 000	Cylinder Head Assembly
⑨	4 4269 400	Intake Pipe Assembly
⑩	4 4281 000	Carburetor Complete Type 40N
⑩-1	4 5115 000	Carburetor Gasket
⑩-2	2 2025 807	Carburetor Retaining Screw (2pcs.)
⑪	4 4203 400	Piston Ring
⑫	4 5803 200	Piston
⑬	4 5806 000	Piston Pin
⑭	4 5205 000	Connecting Rod
⑮	4 5803 100	Cylinder Liner
⑯	4 4207 000	Cover Plate
⑰	4 4202 000	Crankshaft
⑱	4 4230 000	Crankshaft Ball Bearing (Rear)
⑲	4 4201 000	Crankcase
⑳	2 2681 953	Breather Nipple
㉑	4 5231 100	Camshaft Bearing(1pc.)
㉒	4 4262 000	Camshaft
㉓	4 5801 100	Cam Cover
㉔	4 4266 000	Push Rod (2pcs.)
㉕	4 5866 100	Push Rod Cover Assembly (2pcs.)
㉕-1	4 5866 110	Push Rod Cover (1pcs.)
㉕-2	2 4881 824	Push Rod Cover "O"Ring (2pcs.)
㉖	4 5664 000	Cam Follower (2pcs.)
㉗	2 6531 005	Crankshaft Ball Bearing (Front)
㉘	4 5808 000	Drive Hub
㉘-1	2 7708 200	Woodruff Key
㉙	4 5810 100	Lock Nut Set
	7 1615 009	Glow Plug Type F
	4 4225 000	Silencer Assembly Type F-3020
	4 4225 100	Silencer Body
	2 2681 957	Pressure Fitting
	4 4226 000	Exhaust Header Pipe Assembly

Specifications are subject to alteration for improvement without notice.

CARBURETOR EXPLODED VIEW & PARTS LIST

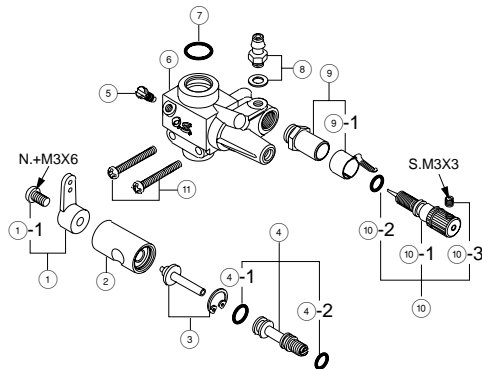

* Type of screw

C...Cap Screw B...Binding Head Screw M...Oval Fillister-Head Screw

F...Flat Head Screw N...Round Head Screw S...Set Screw

No.	Code No.	Description
①	2 2081 408	Throttle Lever Assembly
①-1	2 2081 313	Throttle Lever Retaining Screw
②	4 4281 200	Carburetor Rotor
③	4 4281 960	Nozzle Assembly
④	4 4281 600	Mixture Control Screw Assembly
④-1	4 6066 319	"O" Ring(L)(2pcs.)
④-2	2 4881 824	"O" Ring(S)(2pcs.)
⑤	2 1285 220	Rotor Guide Screw
⑥	4 4281 100	Carburetor Body
⑦	4 5115 000	Carburetor Rubber Gasket
⑧	2 2681 953	Fuel Inlet
⑨	2 7381 940	Needle-valve Holder Assembly
⑨-1	2 6711 305	Ratchet Spring
⑩	4 4281 900	Needle-valve Assembly
⑩-1	4 4281 970	Needle
⑩-2	2 4981 837	"O" Ring(2pcs.)
⑩-3	2 6381 501	Set Screw
⑪	2 2025 807	Carburetor Retaining Screw(2pcs.)

Specifications are subject to alteration for improvement without notice.

PARTS & ACCESSORIES

■ **Radial Mount Set**
(71913000)

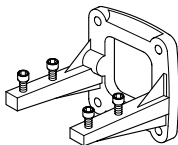

■ **O.S.Glow Plug**
TYPE F
(71615009)



■ **Flexible Exhaust Pipes**



Code.No.	Type	Length (mm)
72108300	1010A	120
72108310	1010B	240

■ **Exhaust Header Pipe 52S(IN-COWL)**
(72108400)



■ **Exhaust Header Pipe Assembly**
(45226000)

■ **Locknut Set for Spinner**
(458102000)



■ **1/4"-M5 Locknut Set**
(45810300)



■ **Bubble Eliminating Tank Weight**
(71531000)



■ **Super Filter(L)**
(72403050)



■ **Long Socket Wrench With Plug Grip** (71521000)

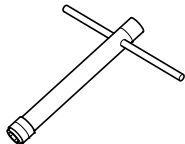

THREE VIEW DRAWING Dimension(mm)

Specification

■ Displacement	8.56cc (0.523cu.in.)
■ Bore	23.0mm (0.906in.)
■ Stroke	20.6mm (0.811in.)
■ Practical R.P.M.	2,300 ~ 13,000r.p.m.
■ Power output	0.9bhp/12,000r.p.m.
■ Weight	434g (15.31oz.)

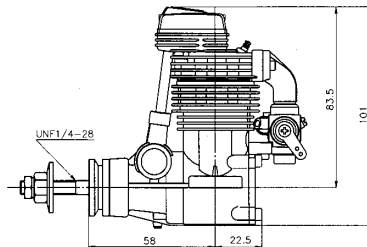
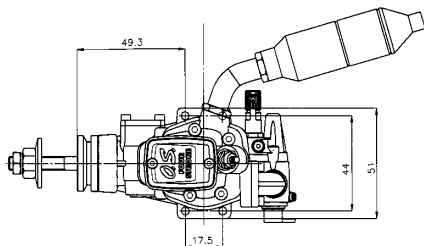



O.S. ENGINES MFG.CO.,LTD.

6-15 3-Chome Imagawa Higashisumiyoshi-ku
Osaka 546-0003, Japan TEL. (06) 6702-0225

FAX. (06) 6704-2722

URL : <http://www.os-engines.co.jp>