

TEAM  ASSOCIATED

1:12 SCALE OVAL KIT

RC12 



**INSTRUCTION MANUAL FOR THE
#4016 RC12L3 OVAL KIT**

SAVE THIS MANUAL!
Use with current catalog for future,
hassle-free re-ordering of parts.

©1999 Associated Electrics, Inc.

RC12 L3 OVAL

#4016

**Factory Team
blue aluminum screws
and ball ends**

**Carbon-fiber
Composite Chassis**

**Race-proven
Dynamic Strut
front suspension**

**Wide
battery
slots**

**Factory Team
blue titanium
turnbuckles**

**VCS Micro Shocks
3 shock design
for best dampening**

**Pro-Line/Jaco
wheel/tire combo
front and rear**

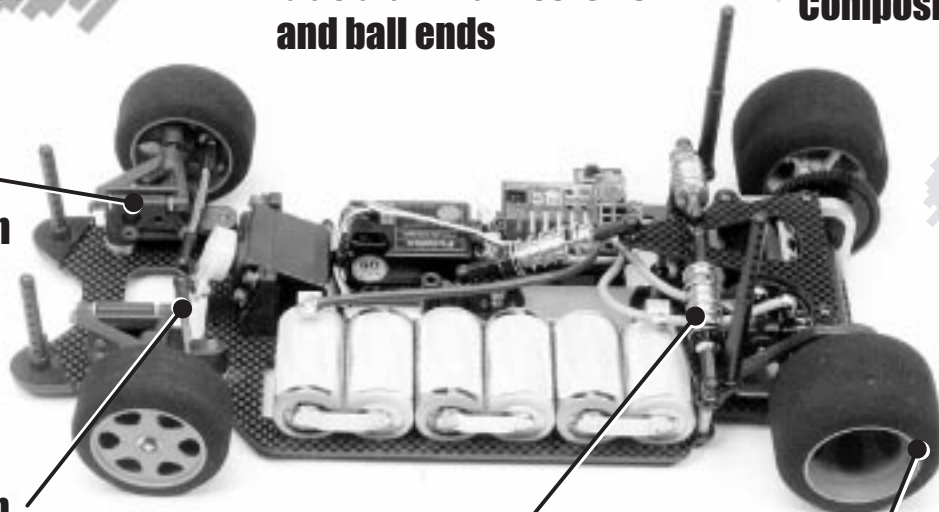

TOOLS

KIT TOOLS SUPPLIED

- 1 Allen wrenches, .050", 1/16", 3/32"
- 2 shock tools
- 3 metal turnbuckle wrench

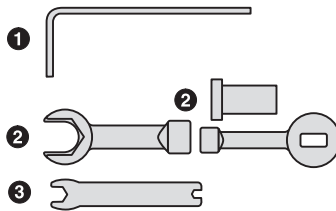

EXTRA STUFF NEEDED

- 1 Phillips screwdriver #2
- 2 needlenose pliers
- 3 soldering iron (40-50 watts) and a small amount of Rosin core solder. Pencil-type soldering iron is better than the gun type. **DANGER! Tip is HOT!**
- 4 hobby knife **WARNING! This knife cuts plastic and fingers with equal ease, so be careful.**
- 5 precision ruler
- 6 file
- 7 hand drill with 3/32" (or #43) drill bit
- 8 electrician's tape
- 9 strapping tape

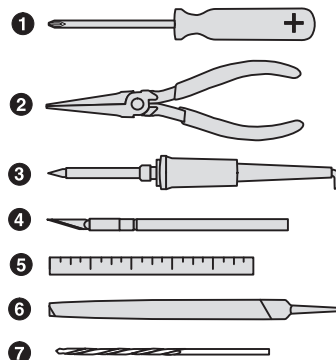

HELPFUL TOOLS (NOT REQUIRED)

- 1 Allen drivers (straight Allen wrenches with hex shaped handles) such as the following made by Associated:
#6957 .050" Allen wrench
#6958 1/16" Allen wrench
#6960 3/32" Allen wrench
#6961 2.5mm Allen wrench
- 2 Vernier calipers
- 3 Hobby scissors
- 4 Nut drivers (screwdriver-handled hex socket tools) such as the following from Associated:
#SP-86 3/16" nut driver
#SP-85 1/4" nut driver
#SP-82 11/32" nut driver

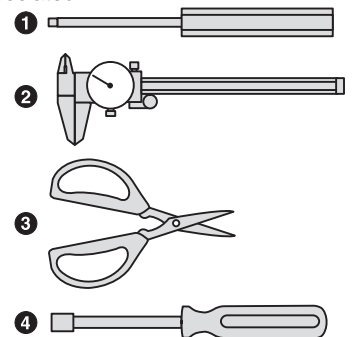

WARNING! Do not use a power screwdriver to install screws into nylon, plastic, or composite materials. The fast rotation speed can heat up the screws being installed. They can then break or strip the threads during installation.

ITEMS NEEDED TO COMPLETE YOUR KIT

- 1 R/C two channel surface frequency radio system.
- 2 *Battery pack (6 cell).
- 3 Battery charger (we recommend a peak detection charger).
- 4 *Electronic speed control.
- 5 *R/C electric motor.
- 6 *Pinion gear, size to be determined by type and wind of motor you will be using.
- 7 1:12 scale Lexan body.

*Available from Team Associated. See your catalogs.

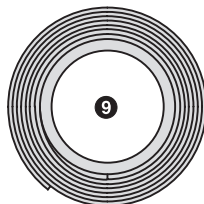
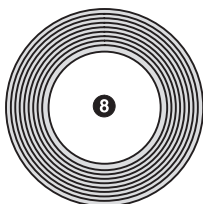

REACHING US

CUSTOMER SUPPORT

(714) 850-9342
Fax (714) 850-1744
web site: <http://www.teamassociated.com>
©1999 Associated Electrics, Inc.



ASSOCIATED ELECTRICS, INC.
3585 Cadillac Ave.
Costa Mesa, CA 92626
USA

BEFORE BUILDING

OPEN THE BAGS IN ORDER

The assembly is arranged so that you will open and finish that bag before you go on to the next bag. **Sometimes you will have parts remaining at the end of a bag. These will become part of the next bag.** Some bags may have a large amount of small parts. To make it easier to find the parts, we recommend using a partitioned paper plate for spreading out the parts so they will be easier to find.

MANUAL FORMAT

The following explains the format of these instructions.

The beginning of each section indicates:

- 1 Which bag to open ("**BAG A**").
- 2 Which parts you will use for those steps. Remove only the parts shown. "**1:1**" indicates an actual size drawing; place your part on top and compare it so it does not get confused with a similar part.
- 3 Which tools you should have handy for that section.
- 4 In some drawings, the word "**REAR**" with an arrow indicates which direction is the rear of the car to help keep you oriented.

5 The instructions in each step are ordered in the order you complete them, so read the words AND follow the pictures. The numbers in circles are also in the drawing to help you locate them faster.

6 When we refer to left and right sides of the car, we are referring to the driver's point of view inside the car.

SUPPLEMENTAL SHEETS

We are constantly developing new parts to improve our kits. These changes, if any, will be noted in supplementary sheets located in a parts bag or inside the kit box. Check the kit box before you start and each bag as it is opened. When a supplement is found, attach it to the appropriate section of the manual.

Now clear off your workbench, line up some paper plates, grab your 50-cent soda, 39-cent cheeseburger, \$12.99 music CD, and let's begin!

BAG A

REMOVE THESE PARTS FOR:

TEAM: step 1

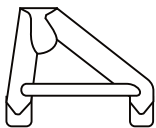

8405, qty 2
upper suspension arm

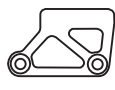

8407, qty 2
0° upper suspension arm mount

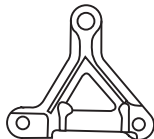

8419, qty 2
lower suspension arm

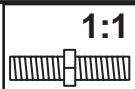

1:1
8415, qty 2
upper suspension arm turnbuckle

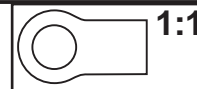

1:1
8411, qty 2
upper suspension arm eyelet

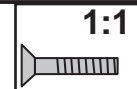

1:1
8409, qty 4
4-40 x 1/2" shoulder screw, blue aluminum



1:1
8417, qty 4
pivot ball

TOOLS USED

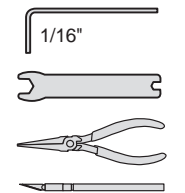

Step 1 LEFT SIDE

ASSEMBLE UPPER SUSPENSION ARM

- 1 Assemble parts #8405, 8415, and 8411.

ATTACH UPPER ARM MOUNT TO LOWER ARM

- 2 Attach #8407 0° mount to the #8419 lower suspension arm using two #8409 screws. **WARNING!** Screws are difficult to screw in. Turn carefully so you do not strip out the head.

INSTALLING UPPER AND LOWER PIVOT BALLS

- 3 Before popping in the #8417 pivot balls, make sure there are no burrs inside the pivot ball holes.
- 4 Pop the #8417 pivot balls into the suspension arms as shown. Make sure that the shoulders of the pivot balls in the lower suspension arms are facing upward and the pivot balls in the upper arm are facing downward as shown. Orient ball to the rounded side of the upper arm as shown.
- 5 Now assemble the right side.

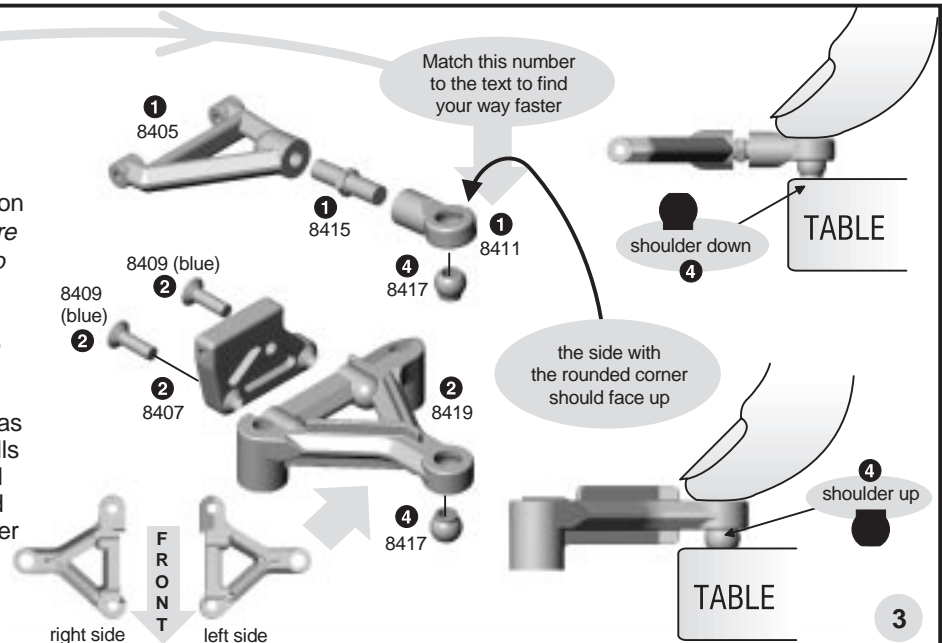

BAG A

REMOVE THESE PARTS FOR:

TEAM: steps 2-3



8439, qty 4
8-32 x 5/8
blue aluminum



4187, qty 4
spacer



8413, qty 4
caster shim

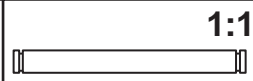

4403, qty 2
kingpin



3323, qty 4
#8 thick washer



6299, qty 6
E-clip



4448, qty 2
ball end
blue aluminum



4449, qty 2
4-40 locknut



4114, qty 2
spring, .018



8425, qty 8
kingpin shim

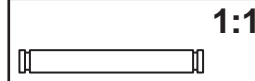

1599, qty 2
axle

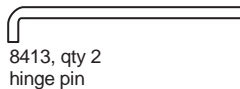

8413, qty 2
hinge pin

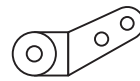

8421, qty 2
offset steering
block

TOOLS USED

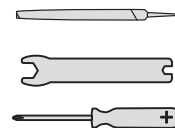

step 2

FILE THE CHASSIS

- Use your file to bevel the slots on the top of the chassis so the edges won't cut through the battery cell wrap.
WARNING! Graphite dust can be harmful to your health. File in a well ventilated area. Then wash the chassis with running water and dry with paper towels. Wash your hands afterward with cold water and soap. Deposit graphite filings in trash.

TAPE THE CHASSIS

- Insulate the battery slots by wrapping the slots with electrical tape.

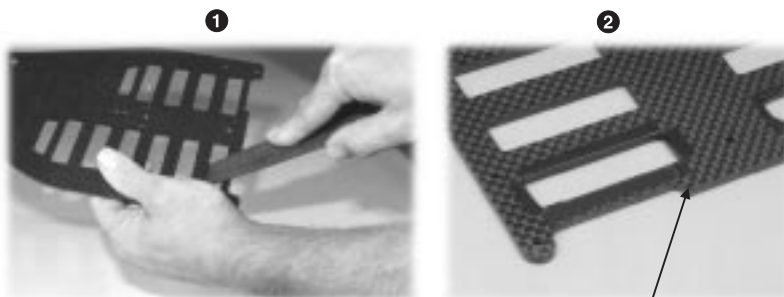

NOTE: The bottom of the chassis has the screw holes countersunk.

chassis 4509

step 3 LEFT SIDE

SUSPENSION ARMS TO CHASSIS

- Place two #3323 washers where shown and bolt the suspension arm on the #4509 chassis with two #8439 blue aluminum screws from underneath the chassis as shown below. Do the other side.

UPPER ARM TO THE SUSPENSION MOUNT

- Assemble the upper arm assembly to the suspension mount as shown, using the #8413 hinge pin and #8413 shims.

FINAL FRONT SUSPENSION ASSEMBLY

- Cut the #8421 steering blocks as shown below. Assemble the steering block as shown using parts #1599, 6299, 4448, 4187, and 4449.
- Place one #6299 E-clip on the bottom of the #4403 kingpin then slide the #4114 spring over.
- Slide the #4403 kingpin completely through the bottom of the suspension arm and up through the steering block.
- Place one #8425 shim on top of the #8421 steering block.
- Now push the upper arm over the kingpin. Place three #8425 shims over the kingpin and secure with a #6299 E-clip.
- Do the other side.

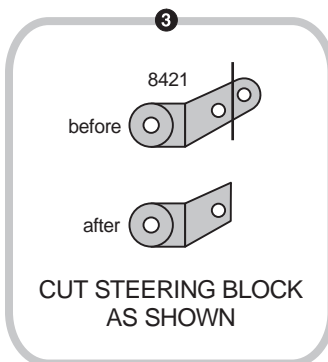
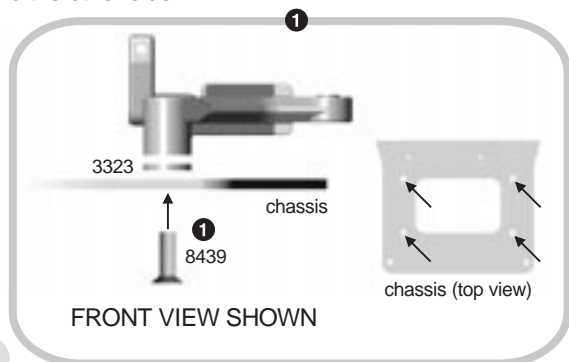
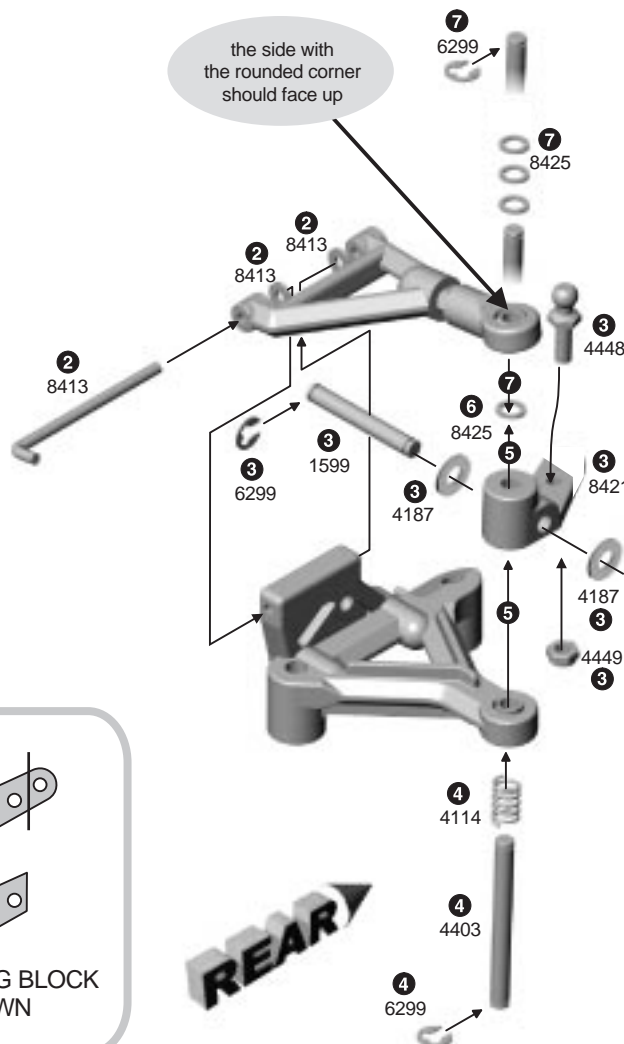

BAG B

REMOVE THESE PARTS FOR:

TEAM: steps 1-3

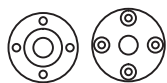

4335, qty 2 ea
pivot socket,
upper and lower



4334, qty 8
2-56 x 5/16



4336, qty 2
pivot ball

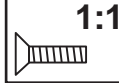

6292, qty 2
4-40 x 3/8



4526, qty 2
T-bar spacer



4449, qty 3
4-40 locknut



6922, qty 1
4-40 x 1/2

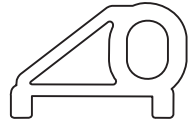

4536, qty 1
left rear bulkhead

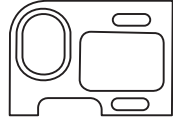

4537, qty 1
motor bulkhead

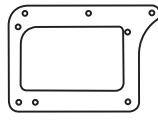

4532, qty 1
lower pod plate

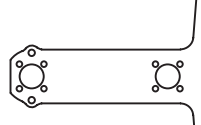

4522, qty 1
T-bar, .063"

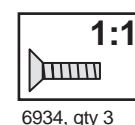

6934, qty 3
4-40 x 3/8
blue aluminum

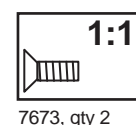

7673, qty 2
4-40 x 5/16

TOOLS USED

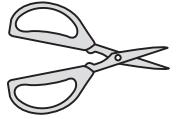

.050", 1/16"

step 1 LEFT SIDE

T-BAR ASSEMBLY

- Assemble the #4335 T-bar sockets and #4336 pivot balls.
- Secure the T-bar pivot assembly to the #4522 T-bar using eight #4334 screws as shown, installing both on the same side of the T-bar. The side with the screw head showing will be the bottom.

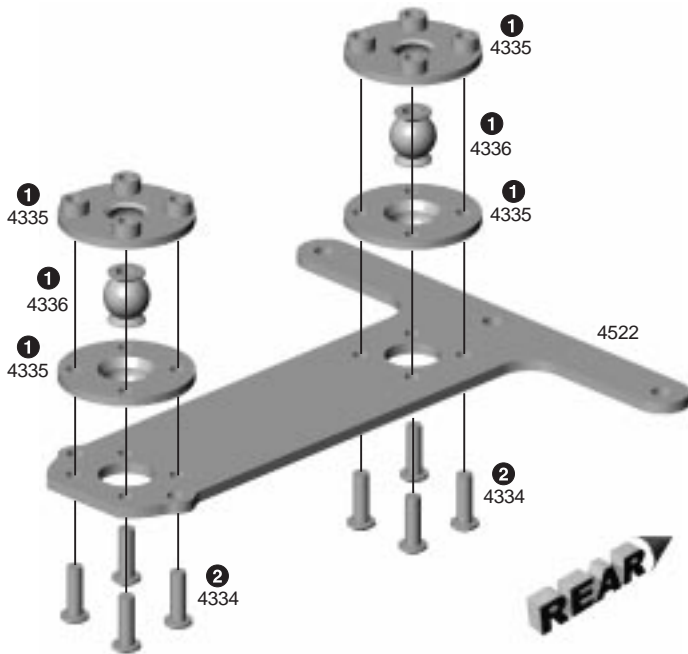

step 2 RIGHT SIDE

REAR POD ASSEMBLY

- Bolt the #4532 lower pod plate to the black #4536 left bulkhead with three #6934 blue aluminum screws.
- Bolt the aluminum #4537 motor bulkhead with two #7673 screws.
- Attach the #4532 lower pod plate to the T-bar with two #4526 spacers, two #6292 screws, and two #4449 locknuts. The spacer goes between the T-bar and the pod plate. The T-bar is on top.

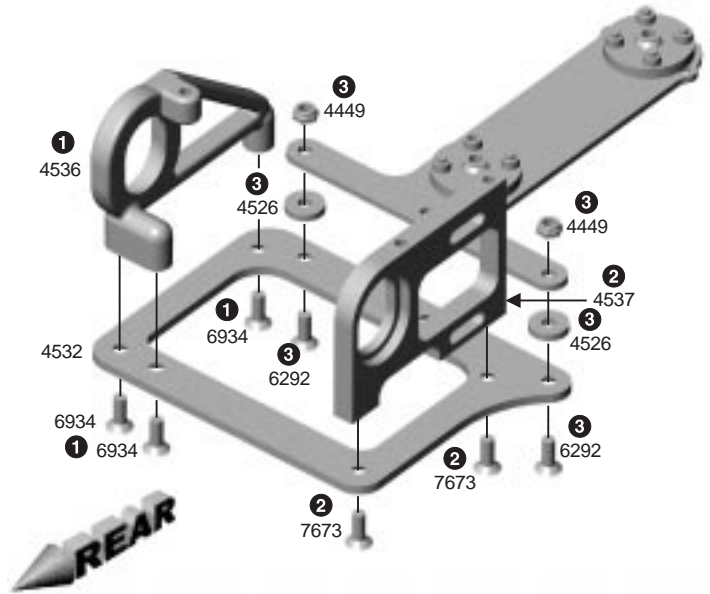

step 3 LEFT SIDE

T-BAR TO CHASSIS



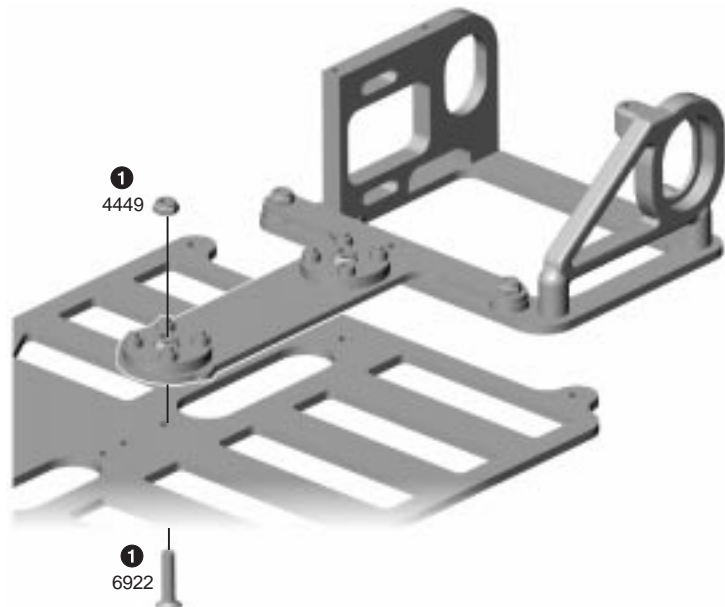



- Insert the #6922 screw through the chassis hole shown and into the T-bar and secure with a #4449 locknut.





BAG B

REMOVE THESE PARTS FOR:

TEAM: steps 4-6

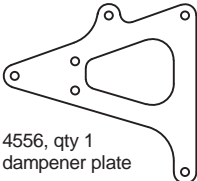
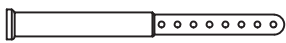
 1:1 4449, qty 5 4-40 locknut	 1:1 7673, qty 2 4-40 x 5/16	 1:1 6919, qty 5 4-40 x 5/16	 1:1 6917, qty 3 4-40 x 3/8	 1:1 4448, qty 5 4-40 ball end blue aluminum	 1:1 4442, qty 2 dampener brace standoff	 1:1 4441, qty 1 dampener center post
--	---	---	--	--	---	--

 1:1 4556, qty 1 dampener plate	 1:1 8818, qty 2 rear body mount	 1:1 4557, qty 1 rear chassis brace	 1:1 6915, qty 1 4-40 x 5/8
---	--	--	---

TOOLS USED

1/16"



step 4 LEFT SIDE

REAR CHASSIS BRACE ASSEMBLY

- Mount the aluminum #4442 and #4441 standoffs to the #4557 rear chassis brace with the #6919 screws.
- Mount the #8818 rear body mounts to the rear chassis brace in the holes shown and secure the mounts using the #6917 screws.
- Mount the #4448 aluminum ball ends to the rear chassis brace with the #4449 locknuts.

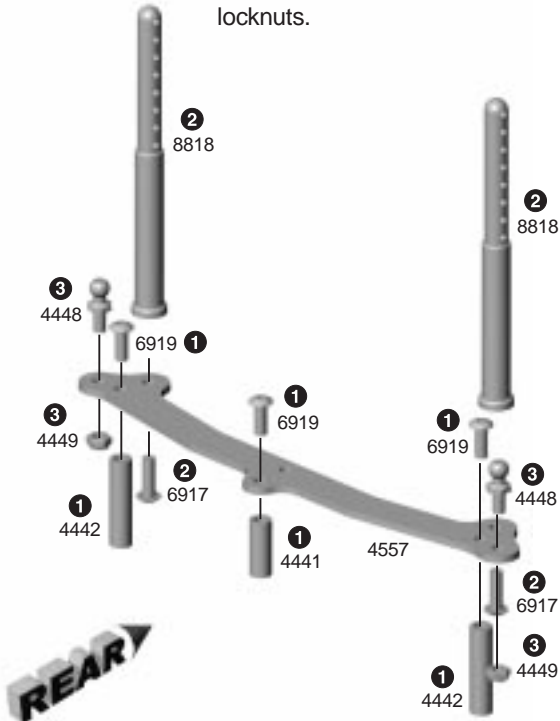

step 5 LEFT SIDE

T-BAR MOUNTING

- Insert the #6915 screw up through the chassis and into the rear part of the T-bar, and screw it into the center chassis brace standoff tube.
- Secure the outside aluminum standoffs to the chassis with the #7673 screws.

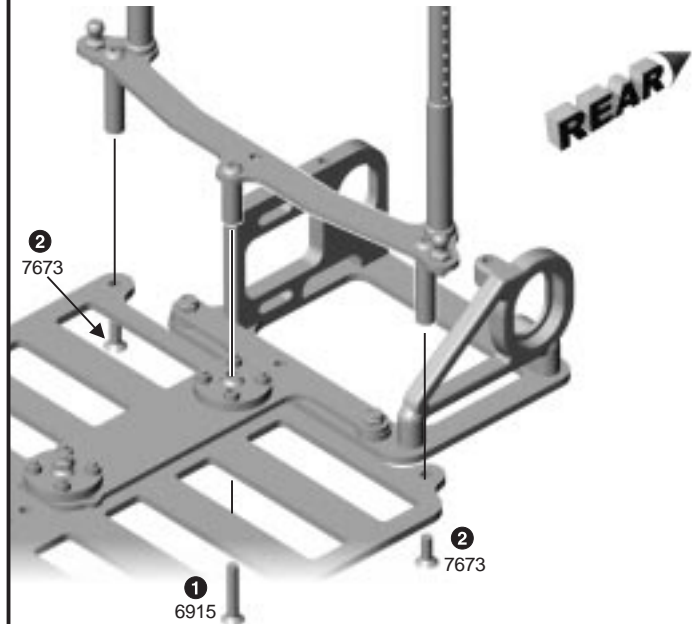

step 6 LEFT SIDE

DAMPENER PLATE ASSEMBLY

- Install the three #4448 ball ends and three #4449 locknuts where shown.
- Install the #4556 dampener plate to the rear pod using two #6919 screws into the aluminum bulkhead and the longer #6917 screw into the plastic bulkhead.

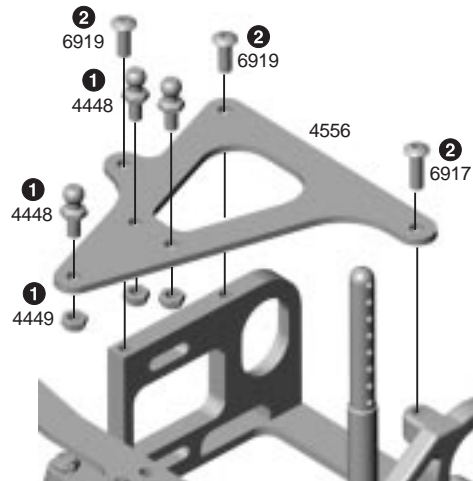

BAG C

REMOVE THESE PARTS FOR:

TEAM: steps 1-4

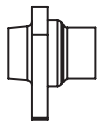

4552, qty 1
left wheel hub



4553, qty 1
right hand rear wheel/
dif spacer

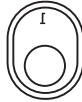

4349, qty 2
ride height
adjuster, #1 down



6636, qty 1
silicone grease

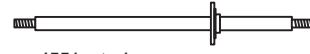

4551, qty 1
graphite axle

TOOLS USED

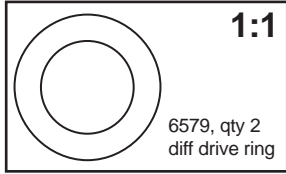
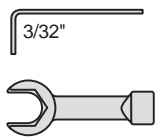

6579, qty 2
diff drive ring



897, qty 3
1/4 x 3/8
flanged bearing

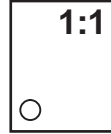

6626, qty 6
1/8" diff ball



4555, qty 1
diff thrust cone

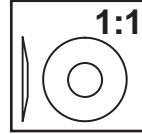

4459, qty 1
Belleville washer

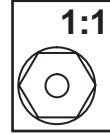

4185, qty 2
8-32 locknut

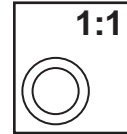

4554, qty 2
rear axle shim



4460, qty 1
diff gear
75 tooth

step 1 LEFT SIDE

DIFFERENTIAL ASSEMBLY

- 1 Find the #4349 adjusters that have a small #1 on them, and insert them into the rear pod, hole down.
- 2 Insert two #897 ball bearings into the ride height adjusters as shown.

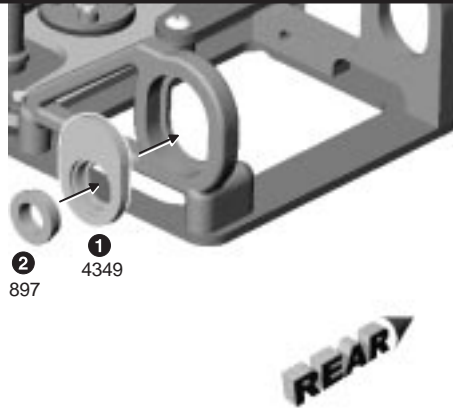

step 2

DIFF GEAR

- 1 Add #6636 silicone grease to the #4460 diff gear ball holes and center hole.
- 2 Push the six #6626 diff balls into the holes.

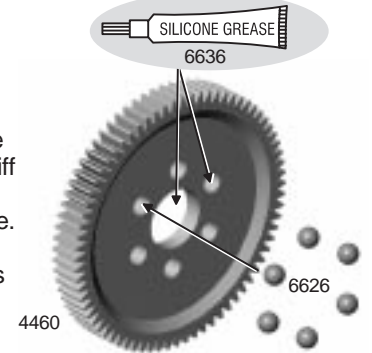

step 3

FINAL DIFF ASSEMBLY

- 1 Hold the #4551 axle upright and apply a small amount of #6636 grease onto the aluminum hub of the axle, and slide the #6579 diff ring over the axle and against the hub.
- 2 Slide the #4460 spur gear over the axle and center it on the hub.
- 3 Apply a small amount of #6636 grease to the second #6579 diff ring as shown. Slide it over the axle, greased side towards the gear. This will keep the diff ring in place while assembling.
- 4 Insert a #897 flanged bearing into the outside end of the #4553 wheel hub. Add a little #6636 grease to the smaller end, then slide the #4553 wheel hub over the axle.
- 5 Install the #4555 cone so that the smaller end is facing the bearing. Place the #4459 Belleville washer over the axle so that the smaller end faces away from the cone, and secure with a #4185 locknut. We will adjust the diff after we put the wheels on.

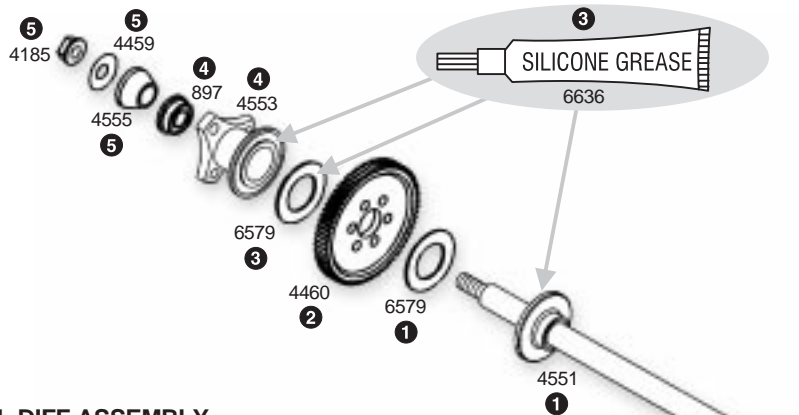

step 4

CHECK THE END PLAY

- 1 Screw on the #4552 left wheel hub, then check the axle for side to side end play. Use the #4554 shims to take up any excess end play, if needed.
- 2 When you have finished setting the axle end play, install the #4185 locknut to secure the left wheel hub.

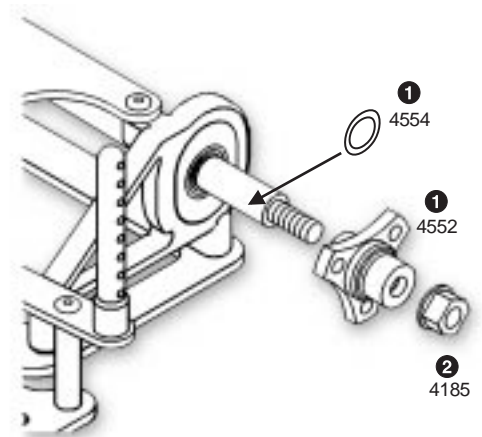

BAG D

REMOVE THESE PARTS FOR:

TEAM: steps 1-5



4473, qty 3
black VC foam



4473, qty 3
VC housing



4472, qty 3
shock shaft and piston

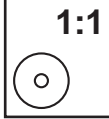

4473, qty 3
large washer

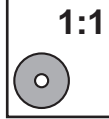

4473, qty 3
red O-ring

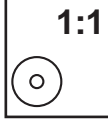

4473, qty 3
small washer

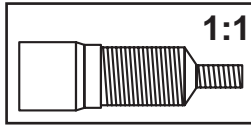

4471, qty 3
micro shock body

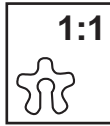

4473, qty 3
star clip

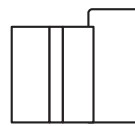

4511, qty 1
shock mount

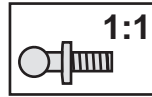

4448, qty 1
ball end
blue aluminum

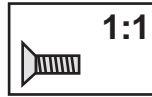

6933, qty 2
4-40 x 5/16
blue aluminum



5422, qty 1
30 wt
silicone oil

TOOLS USED

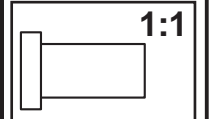

4473, qty 1
assembly tool



step 1

- 1 Install the #4511 shock mount using two #6933 screws.
- 2 Add one blue aluminum #4448 ball end to the hole shown.

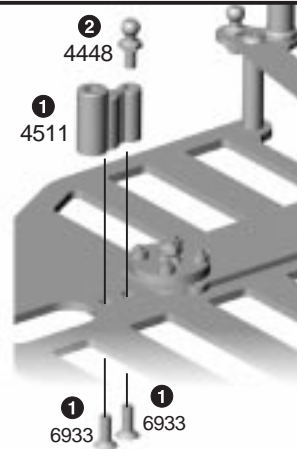

step 2

- 1 Remove the plastic #4473 VC housing from the parts tree.
- 2 Soak the #4473 VC foam with your #5422 shock oil.
- 3 Push the foam into the #4473 housing.

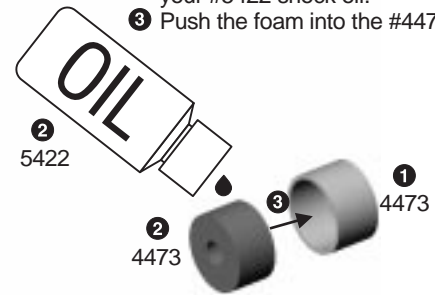

step 3

- 1 Fill #4471 shock body with oil up to the upper groove.
- 2 Insert #4472 shaft/piston all the way to the bottom.



step 4

- 1 Remove the small and large #4473 washers from the parts tree. Remove any flash from the washers.
- 2 Slide the VC housing with foam onto the shaft, housing first (so foam is still seen through the body opening).
- 3 Slide on the following in this order: smaller washer, red O-ring, larger washer, then the star-shaped clip.

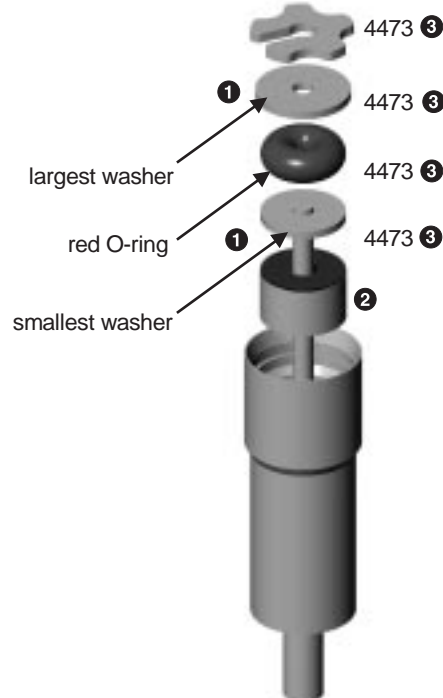

step 5

Use the assembly tool to push all the parts down into the body until the clip snaps into the groove. When you remove the tool, the shaft will push out somewhat if everything snapped into place correctly. **Make sure the clip snaps into the groove completely.**

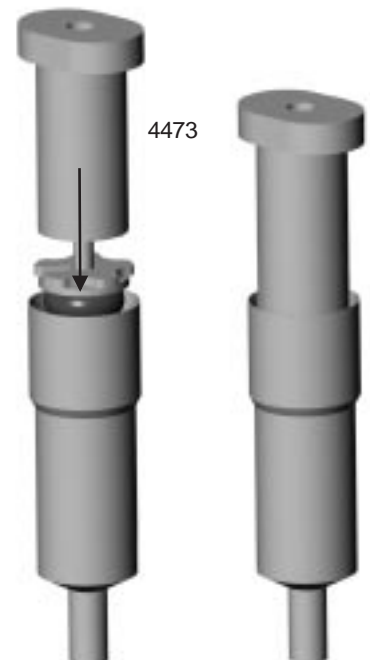

BAG D

REMOVE THESE PARTS FOR:

TEAM: steps 6-8



6274, qty 6 ball cup



4473, qty 3 spring adjusting nut



4474, qty 3 shock shaft end



6951, qty 3 set screw



8451, qty 3 silver spring

TOOLS USED

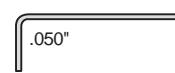

disassembly rod

step 6

- 1 Remove the assembly tool and screw on the #6274 ball cup where shown.
- 2 Screw the #4473 spring adjusting nut onto the shock body threads, flange first, as shown.

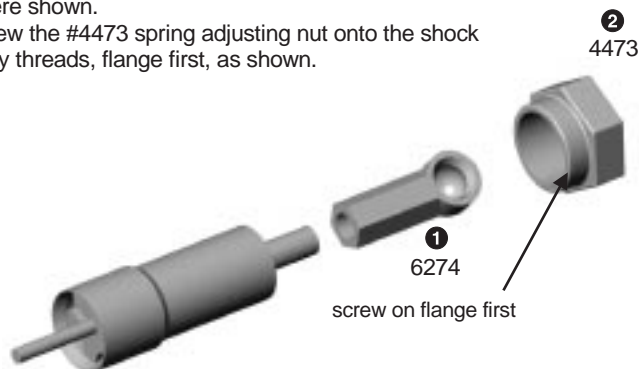

step 7

- 1 Slide the #8451 spring over the body and up against the #4473 adjusting nut.
- 2 Screw the #6274 ball cup onto the #4474 shock shaft end.
- 3 Tighten the #4474 shock shaft end to the shaft with the #6951 set screw.

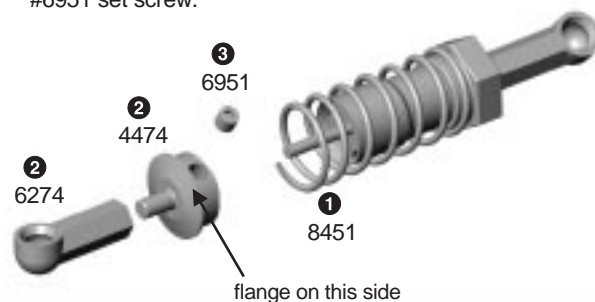

step 8

- 1 Pop the #6274 ball cups on the ball ends of your kit.
- 2 Turn the spring adjusting nut to adjust spring tension.
- 3 Adjust spring nut to 1/16" from threaded end.
- 4 Do the other two shocks.

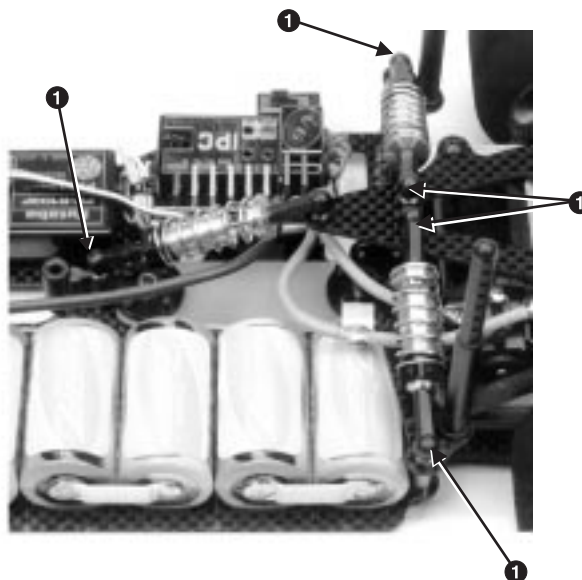
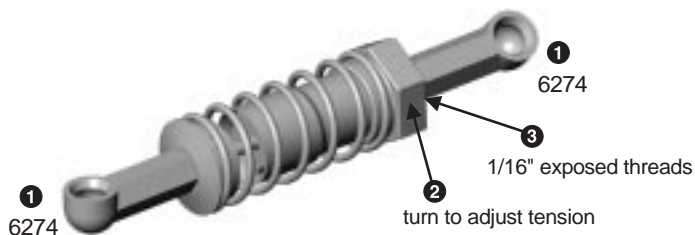

PHOTO DEPICTS FULLY-ASSEMBLED KIT

DISASSEMBLY

- 1 To remove the parts from inside the shock, first loosen the #6951 set screw of the #4474 shock shaft end (see step 7 above), then slide off the shaft end and spring.
- 2 Now carefully insert your disassembly rod into one of the rounded grooves of the star clip and pop it out.



MISC. BAG

REMOVE THESE PARTS FOR:

TEAM: step 1



3656, qty 4
1/8 x 5/16
unflanged ball bearing

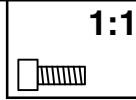

6285, qty 6
4-40 x 1/4
steel



6299, qty 2
E-clip

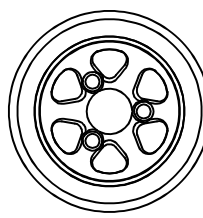

3627, qty 2
rear wheel/tire

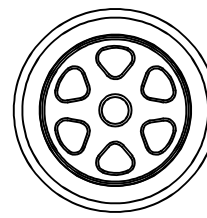

3673, qty 2
front wheel/tire

TOOLS USED

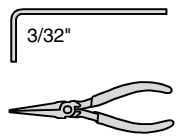

step 1

MOUNTING REAR TIRES

Install both #3627 rear tires to the hubs with three #6285 screws into each wheel hub.

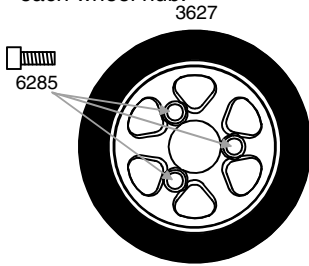

SIDE VIEW SHOWN

MOUNTING FRONT TIRES

Put a # 3656 unflanged ball bearing into each side of the front wheels. Be sure the #4187 washer is still over the axle, then slide the wheel on and secure it with a #6299 E-clip. Install the other wheel the same way.

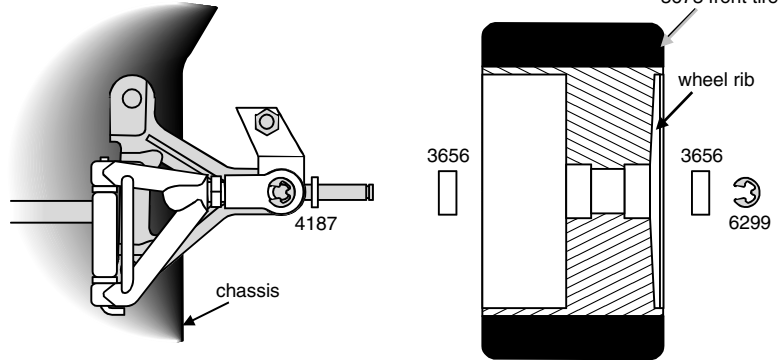

TOP VIEW SHOWN

step 2

DIFFERENTIAL ADJUSTMENT

- While holding rear wheels with your hands, use your right thumb and index finger to try and rotate the spur gear. The spur gear should be very difficult to rotate. If you can rotate it easily, then tighten the #4185 11/32" nut at the end of the axle, **a little at a time**, until the spur gear is difficult to rotate.

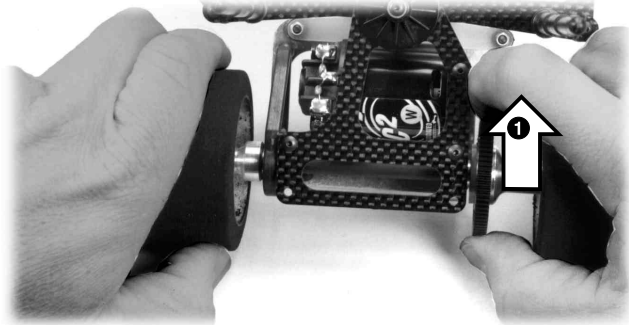

BAG E

REMOVE THESE PARTS FOR:

TEAM: steps 1-3



4449, qty 2
4-40 locknut

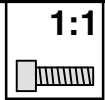

4145, qty 4
4-40 x 5/16
blue alum.

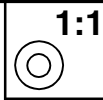

7337, qty 4
#4 washer

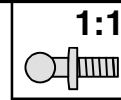

4448, qty 2
ball end

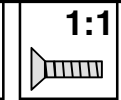

6934, qty 2
4-40 x 3/8
blue alum.

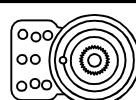

3760, qty 1
servo saver

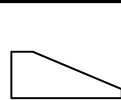

8435, qty 2
servo mounting block

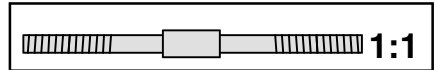

1404, qty 2
blue titanium turnbuckle

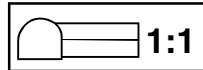

6274, qty 4
ball cup

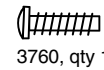

3760, qty 1
servo saver screw

TOOLS USED

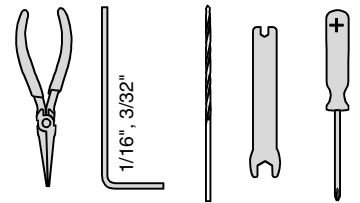

step 1

DRILLING STEERING SERVO BLOCKS

- These holes are recommended for Airtronics: 94144, 94145.
- These holes are recommended for Futaba: S3002, 9601, 9602; and for Hitec: HS-235AG, HS-225BB, HS-225MG.
- Drill two holes with a #43 (or 3/32") drill into the #8435 servo blocks where shown for your servo size.

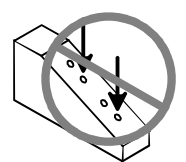
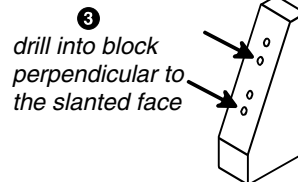
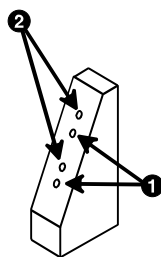

NO! Don't drill into the block at an angle to the slanted face

step 2

MOUNTING THE SERVO

- Secure the servo to the #8435 blocks with four #4145 screws and four #7337 #4 washers.

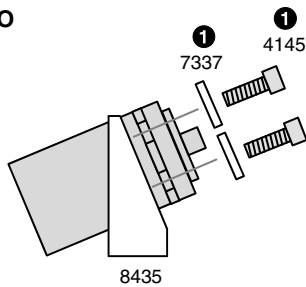

DRILL SERVO SAVER

- Use your #34 or 3/32" drill bit to carefully drill the two mounting holes for the #4448 ball ends.

ASSEMBLING THE SERVO SAVER

- SAVER**
Thread two #4448 ball ends into the front side of the #3760 servo saver. Secure the ball

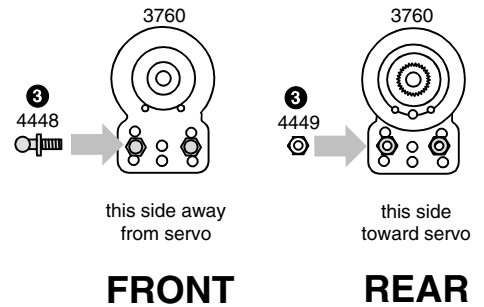

MOUNTING THE SERVO ASSEMBLY

- Mount the servo saver to the servo with the #3760 screw. **Note:** If you have a metal gear servo, use the stock mounting screw.
- Drill the chassis holes for your servo mounting blocks according to the drawing with a #33 (or 7/64") drill bit. We have provided starter holes for your convenience. We strongly recommend using 82 deg. countersink (or the tip of a 1/4" drill bit). **Be sure to countersink the bottom side.** Mount the servo mounting blocks to the chassis with two #6934 screws using the proper holes for your servo, as shown.

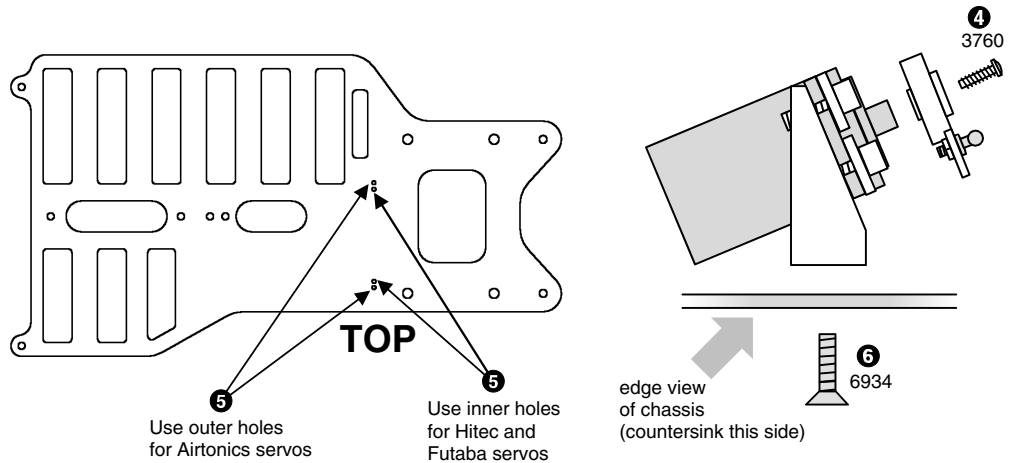

step 3

STEERING LINKAGE

- Install the plastic #6274 ball cups onto the #1404 steering turnbuckles. Match the length of the turnbuckles to the actual size picture.
- Snap one ball cup onto the ball end on the servo saver. Snap the opposite end on as shown. Install both
- turnbuckles.
When you are adjusting your turnbuckles, always make sure that the servo saver is pointing straight down.

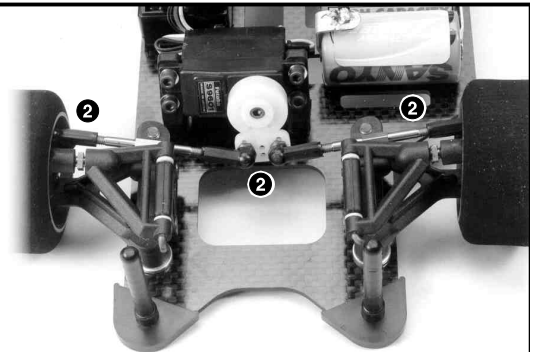
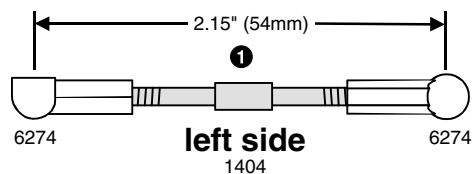
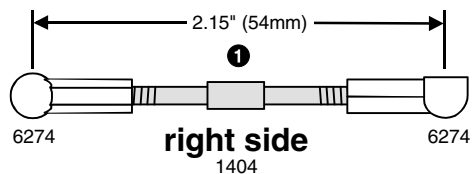

BAG E

REMOVE THESE PARTS FOR:

TEAM: steps 3-4

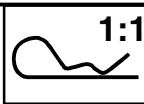

6332, qty 4
body clip

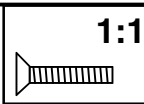

9269, qty 2
5-40 x 1/2

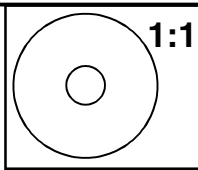

7320, qty 2
large body washer

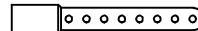

4535, qty 2
front body mount

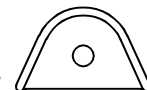

4508, qty 2
chassis protector

TOOLS USED



step 4

FRONT BODY MOUNTS

- 1 Place the #4508 chassis protector on the front chassis tip, and slide the #9269 screw up from the bottom as shown into the #4535 front body mount.
- 2 Add one #6332 body clip to the post according to your body height. Put your painted body on, add the #7320 body washer to the mount over the body, and top off with the other #6332 clip.

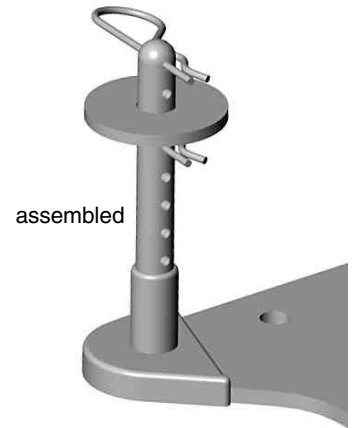
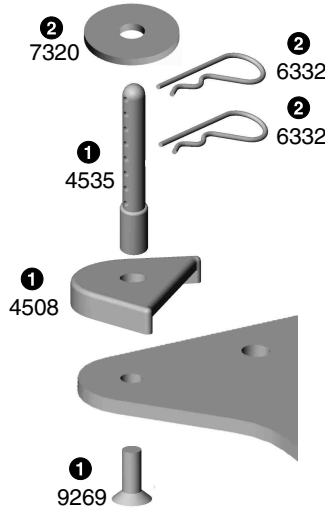

BAG E

REMOVE THESE PARTS FOR:

TEAM: steps 5-6

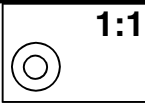

7337, qty 2
washer

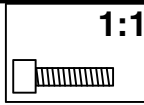

6515, qty 2
3mm x 10mm
gold

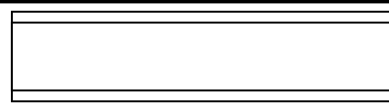

6726, qty 1
servo tape strip

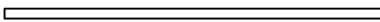

4510, qty 1
roll over antenna



4510, qty 1
antenna cap

TOOLS USED

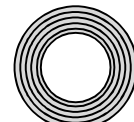

strapping tape

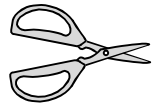

step 5

PINION GEAR INSTALLATION

- 1 Slide the pinion gear purchased separately onto the shaft so that the gear is 1/16" away from the motor can and tighten the set screw to hold it in place.

MOTOR INSTALLATION

- 2 Insert the motor, the pinion gear coming through the right side motor bulkhead.
- 3 Tighten the motor to the bulkhead with two #6515 screws and two #7337 gold washers.
- 4 Set the gear mesh so that there is very little play between the spur and pinion gear.

ELECTRICAL INSTALLATION

- 1 Solder your single cell batteries together with battery braid or battery bars. Solder plus (+) to minus (-).
- 2 Strap the batteries to the chassis with strapping tape.
- 3 Attach your speed control and receiver where shown with the #6726 servo tape.
- 4 Insert the #4510 roll over antenna into the antenna mount, wrap the antenna wire up the antenna, and secure the wire with the antenna cap.
- 5 Now connect the electronic speed control and steering servo to your receiver according to your radio or ESC instructions, then connect the motor and batteries to the ESC.

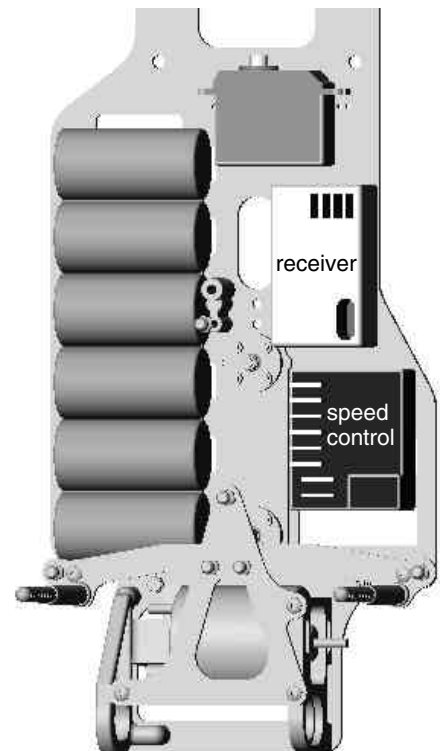
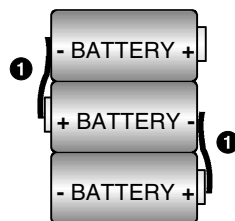

SETTING THE TWEAK

We set the “tweak” after everything except the body is installed on the car, including batteries, motor, speed control, and all the radio equipment.

WHAT IS TWEAK? Ideally, the left wheel should be pushing down on the ground with exactly the same force as the right wheel. If this is not happening, the car is TWEAKED (or twisted). This can cause the car to spin out easily under acceleration. It will also cause the car to oversteer in one direction and understeer in the opposite direction.

CHECKING THE TWEAK.

- 1 Measure the front chassis width. Use half of this measurement to find the centerline of the chassis.
- 2 Scratch a mark at the centerline at the front of the chassis with your hobby knife as in photo.

3 To tweak the car, place the tip of a hobby knife on the center mark as shown.

4 Lift the front of the car slowly. For a neutral handling car, we want both front tires to leave the ground at the same time. If one tire leaves the ground before the other one, the car is tweaked.

ADJUSTING THE TWEAK. After checking the tweak, tighten the spring adjusting nut (page 9, step 8) 1/2 turn on the tire side that left the ground first. Now loosen the opposite shock spring adjusting nut the same amount. Now recheck the tweak. Continue to make these adjustments until you achieve the amount of tweak desired.



Here are some guidelines to optimize tweak:

- Both tires leave the ground at the same time: neutral, easy-to-drive steering.
- Left front tire leaves the ground first: less steering (understeer).
- Right front tire leaves the ground first: more steering (oversteer).

TUNING & SETUP TIPS

THESE STEPS PREPARE YOUR CAR FOR MAXIMUM PERFORMANCE

Your car is one of the most tunable on road cars on the market. This section will try to explain the parts and adjustments you can use to tune your car for different track conditions.

CASTER describes the angle of the kingpin, in relation to the vertical plane, when looked at from the side of the car. As an example, 0° of caster puts the kingpin in a vertical line. Positive caster means the kingpin leans rearward at the top. Increasing the positive caster on your car will slightly increase the steering turning into a corner and slightly decrease steering coming out of the corner. Reducing the positive caster will decrease the amount of steering you have going into a corner and increase the amount of steering you have in

the middle of the corner and exiting the same corner.

Your car has adjustable caster in increments of 2°. With the 0° upper arm mounts you can have settings of 0°, 2°, and 4° of positive caster. You change the caster by placement of the PTFE caster shims on either side of the upper arm mount.

The three drawings below show the locations of the caster shims and what the resulting caster settings will be.

For greater amount of caster than moving the upper arm caster shims, you can add the #4127 caster spacers under the suspension arms. They come in 2° increments. Be aware that adding these caster shim spacers will change your ride height.

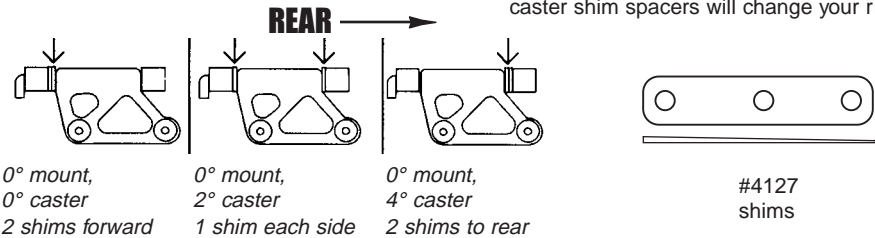

CASTER CHANGE

The 0° mount is level with the chassis when mounted. The 10° mount is angled 10° in relation to the chassis or lower suspension arm. This angle provides a change in caster during suspension movement. The caster angle will change two degrees during full suspension travel. Your car will steer more aggressively when using this option. The starting or static caster setting is changed in the same manner using the PTFE caster shims. Static caster starts at either 2°, 4°, or 6°. A more detailed

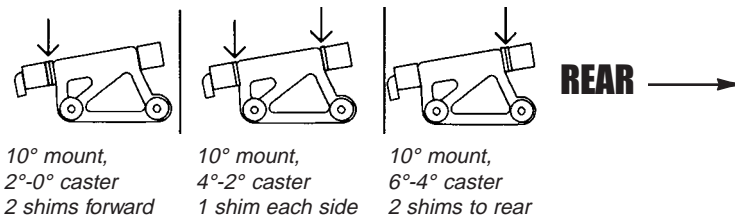

example would be a starting caster of 2° will have 0° caster at full suspension travel and a starting caster of 6° will be only 4° at full suspension travel.

This setup is recommended for road racing applications, giving you the most aggressive steering possible.

CAMBER is a word describing the angle at which the tire and wheel rides relative to the ground when looked at from the front or back. This is one of the most important adjustments on the car. Negative camber means that the tire leans inward at the top, putting it closer to the centerline of the car than the bottom of the tire. Positive camber means just the opposite, the top of the tire is further away from the centerline of the car than the bottom of the tire.

Excessive negative camber will decrease traction but increase stability. Positive camber will do the same. We suggest a starting setting of 2° of negative camber. Try to use at least 1° to 2° negative camber at all times and make adjustments to keep your tires wearing flat. This can be adjusted by turning the upper arm turnbuckles in the appropriate direction.

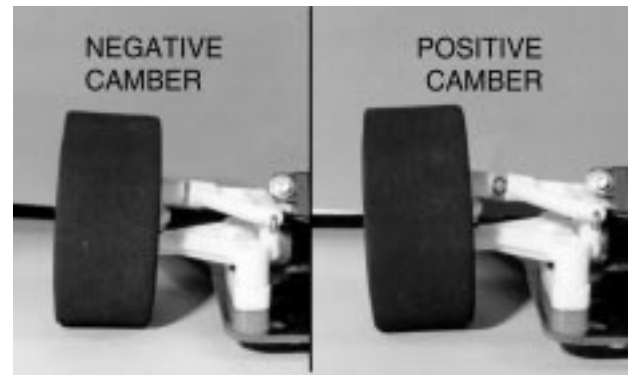

TOE-IN AND TOE-OUT is a beneficial adjustment and has a fairly significant effect on the car. Toe-in will help stabilize your car and it also removes a small amount of turn in steering. Toe-out will allow the car to turn in to a corner quicker but will reduce stability exiting the corner. Both toe-in and toe-out will scrub speed so try to use as little, of either, as possible. You adjust the toe-in or toe-out by adjusting the length of the steering tie-rod turnbuckles.



FRONT SUSPENSION SPRINGS

are available in various wire sizes as listed here. Changing springs will increase or decrease steering. In general, a softer spring (smaller wire diameter) will add steering and a harder spring (larger wire diameter) will decrease steering. Oval racing will normally require a harder spring than road course racing. The #4015 12L3 kit includes #4414 springs.

Part Number	Wire Size
#4116	(.024")
#4117	(.022")
#4113	(.020")
#4114 (kit spring)	(.018") (kit spring)
#4119	(.016")
#4118	(.014")

Harder (less steering)



Softer (more steering)

T-BAR THICKNESS AND FLEX

Your RC12L3 comes with the #4522 T-bar, with a thickness of .063". An optional #4520 T-bar has a thickness of .075". The .063" T-bar is the recommended thickness for low traction conditions. The .075" T-bar is recommended for high-traction conditions. If you use the .075" T-bar, your car will turn more aggressively, but will not be as smooth accelerating through bumps. The .063" T-bar will give the car more rear traction and will seem smoother through the bumps. We recommend using the .075" T-bar when racing on smooth carpet tracks with good traction.

Look at the back end of the of the T-bar at the "T" shaped section. You will see there are three holes which can be used to attach the T-bar to the lower rear pod plate. You have assembled your car using only the two outermost holes. This setup will make the rear suspension very active (soft) front-to-rear with very little effect on the side to side stiffness. Your car will have more rear traction and will accelerate through bumps better than if you were using all three attachment holes. Try using all three attachment holes when racing on smooth, high traction conditions.

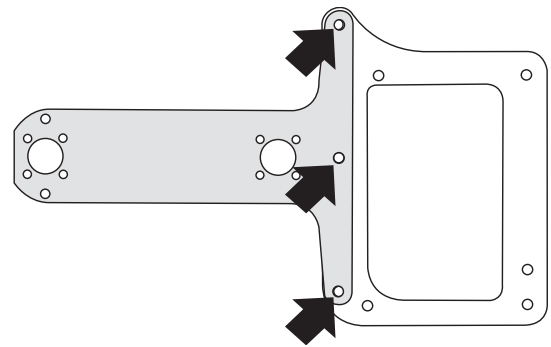

REAR AXLE HEIGHT ADJUSTERS

Your car comes with four sets of rear axle height adjuster inserts. These inserts allow you to raise or lower the height of the back of the car without changing tire diameters. Even though there are only four offsets, three can be rotated 180° for a total of seven different axle heights as shown.

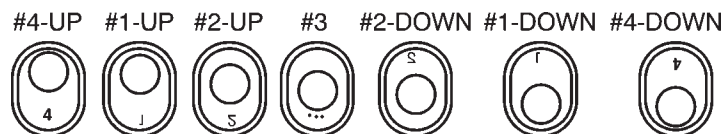

The #4-up position allows you to use the maximum diameter tire and the #4-down position requires you to use the minimum tire diameter. This adjustment allows you to get more useful life from a set of tires by adjusting axle height as tire diameter decreases. You can also adjust the overall height of your car for high or low traction conditions.

FRONT RIDE HEIGHT

To obtain your desired ride height, you can place a thick #3323 aluminum spacer under the lower suspension arm. To raise the car, take away spacers, and to lower the car, add spacers.

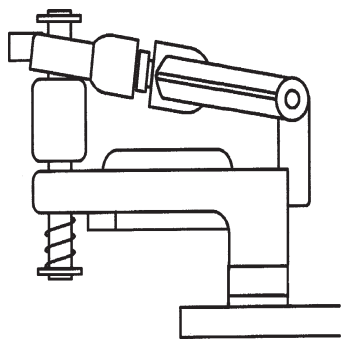

SETUP SHEET

The next page shows Team Associated's setup sheet for your car. Copy this form and keep a record of the settings you used for a particular track. This record of your settings will make it easier to set up your car the next time you race at that track, as well as compare differences between tuning adjustments. This is a feature that our Team drivers take full advantage of.

SAVE THIS BOOKLET!

More than an instruction manual, its also a handy pictorial supplement to Team Associated's RC12L3 catalog.

Refer to this manual for part numbers and description when ordering parts or to explain problems for customer service calls.

TEAM ASSOCIATED

3585 Cadillac Ave.
Costa Mesa, CA 92626
(714) 850-9342
fax (714) 850-1744
<http://www.rc10.com>



TEAM ASSOCIATED ONLINE!

<http://www.teamassociated.com>

Get online help, tips, and new products for your kit through Team Associated's web site!

Tech Help, where answers to racers' questions are posted for all to learn from.

Racer Spotlight, where other racers proudly show off their favorite kit.

Setup Sheets, where racers go to find blank and standard setups to download for their kit.

New Products, where you learn of new kits and parts before they are announced anywhere else!

Team Associated Insiders Newsletter. Sign up for it on the Home Page if you want news delivered right to your e-mail box!

Question of the Week. Join in and give your opinion of the topic of the week, and learn from other racers.

Hobby Shop and Track listings. Shops that carry Associated parts and where you can race your kit.

R/C Kits and Parts. Online catalogs updated with new parts as soon as they come out.

Feedback Form. Tell us what's on your mind with this exhaustive survey.



Help Form. Our expert staff answers your toughest questions about Associated, Reedy, and LRP products.

Free Stuff. Get your Associated kit computer wallpaper and screensavers here!

RC12 L3 OVAL

SETUP SHEET

DATE: _____
 DRIVER: _____
 TRACK NAME: _____
 EVENT: _____

TIRES/WHEELS	FRONT	REAR
TIRE TYPE		
TIRE DIAMETER		
STAGGER		
WHEEL TYPE		
TRACK WIDTH (car)		
TIRE TREATMENT TYPE		
SHADE IN AMOUNT OF TIRE TREATMENT:		
	FRONT	REAR
	outside →  ← inside	inside →  ← outside

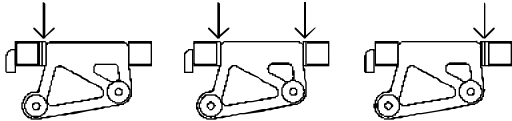
FRONT END	FRONT CASTER circle one:
FRONT SUSP. SPACERS, QTY:	
FRONT SPRINGS, LEFT: _____ RIGHT: _____	
UPPER ARM MOUNTS: <input type="checkbox"/> 0° <input type="checkbox"/> 10°	
FRONT CAMBER	

REAR END
SHOCK OIL, CENTER: _____ SIDES: _____
SHOCK SPRING, CENTER: _____ SIDES: _____
T-BAR THICKNESS
Using dampener assembly instead of side shocks: <input type="checkbox"/> DAMPENER ASSY <input type="checkbox"/> SIDE SHOCKS
REAR RIDE HEIGHT ADJ.: <input type="checkbox"/> #4-up <input type="checkbox"/> #1-up <input type="checkbox"/> #2-up <input type="checkbox"/> #3 <input type="checkbox"/> #2-down <input type="checkbox"/> #1-down <input type="checkbox"/> #4-down

BODY & ELECTRONICS	
BODY TYPE AND MAKE	SPOILER/WING <input type="checkbox"/> yes <input type="checkbox"/> no POSITION: _____
BATTERY TYPE	NUMBER OF CELLS
MOTOR TYPE & WIND	BRUSH TYPE _____ BRUSH SPRING
GEAR RATIO	SPUR SIZE _____ PINION SIZE
SPEED CONTROL	CURRENT LIMITER
RECEIVER TYPE	

TRACK DESCRIPTION:

RACE COMMENTS:

CAR COMMENTS:
