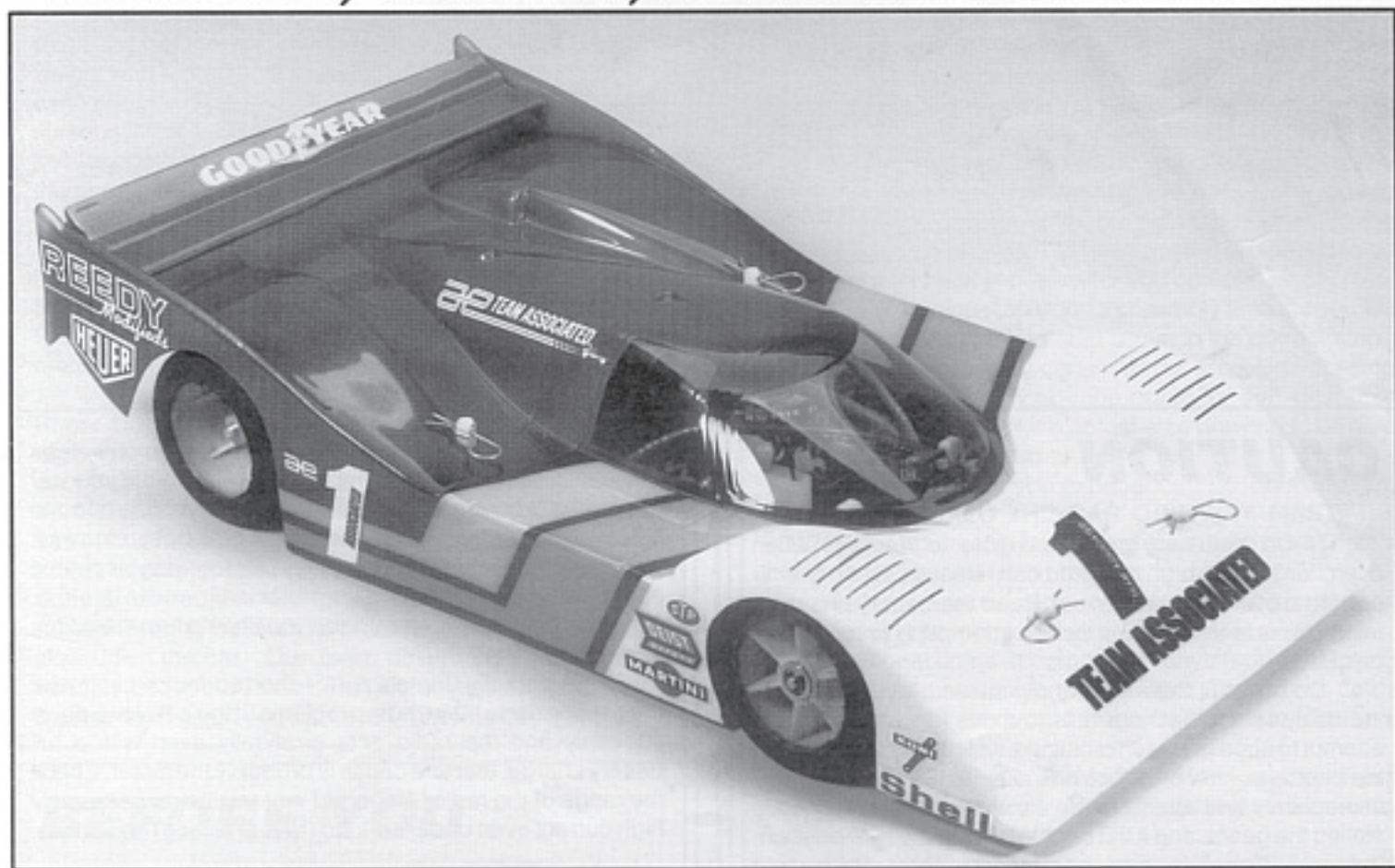


# NEW RC12LS RACING CAR KIT WITH NEW FRONT SUSPENSION

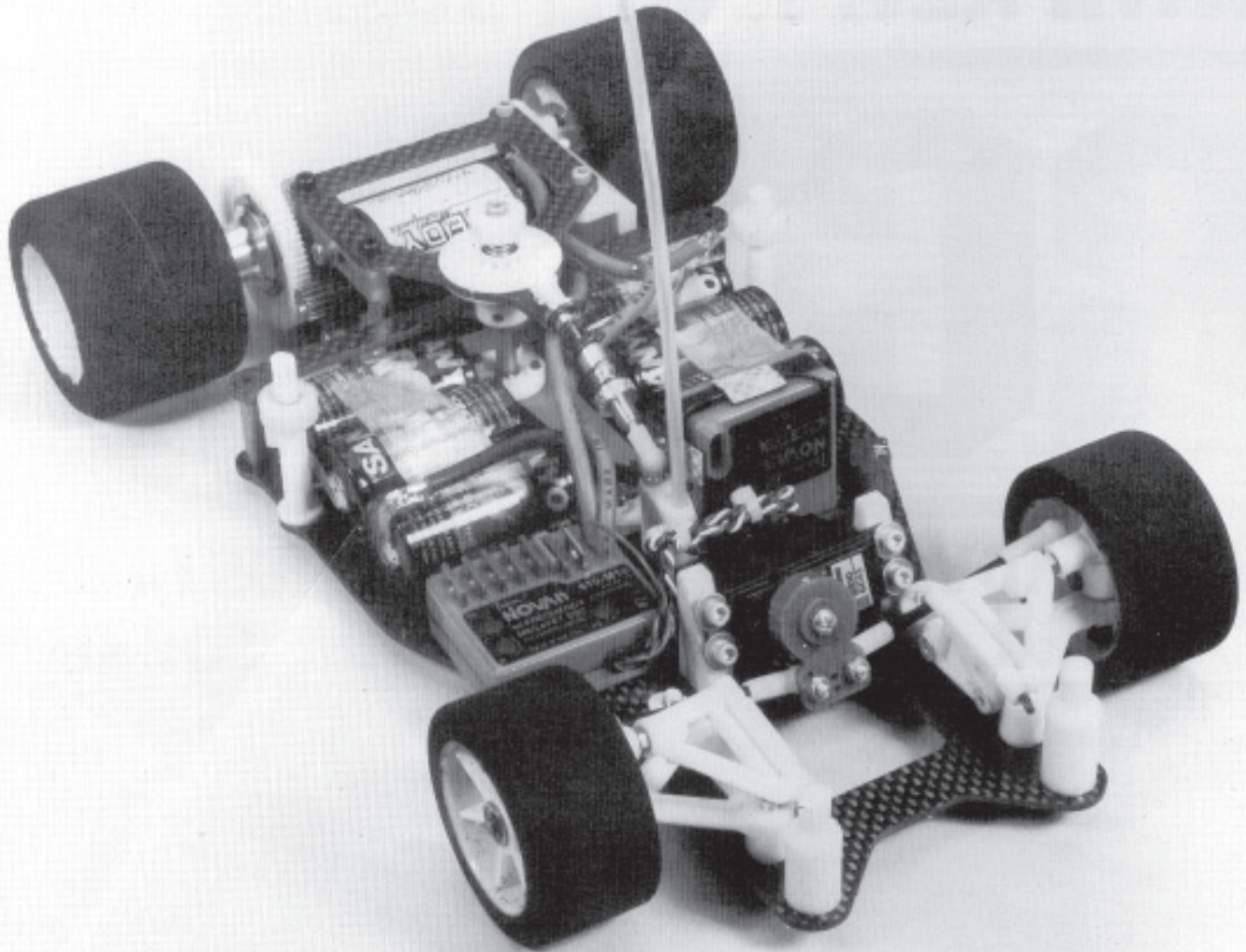
# RC12LS

WITH ADVANCED, EASILY ADJUSTABLE  
CAMBER, CASTER, TOE IN AND TOE OUT



# INSTRUCTION MANUAL

# RC12LS GRAPHITE



## CAUTION

Ni-Cd batteries are susceptible to damage when overcharged at a high rate, and can release caustic chemicals if the overcharge is severe. Read the battery charging instructions in this manual before attempting to run your car.

Do not stall the motor under power. If the car stops suddenly on the track, or fails to move forward when you attempt to accelerate (after hitting a wall, for instance), push the throttle control on your transmitter to the brake position immediately and attend to the car. A small rock may have stalled the gears, and if the throttle is left in the "on" position, the result can be a burned-out motor or resistor or electronic speed control unit.

If you run your car to the point where more than one cell in the pack is completely discharged, it is possible to

lose radio control of the car before the drive motor stops completely. For this reason you should not operate your car in an area where it could be damaged or cause harm to others, such as near a pool of water or a busy roadway. Usually radio control will be regained as soon as you pull the car from the obstruction and the motor is allowed to free-run. If you still don't have control, then you should turn the switch off.

A partially burned-out or shorted motor can make the car appear to have radio problems. If the car slows down suddenly and the radio acts erratically even with a full battery charge, then the cause is probably the motor. Check the range of the radio. A shorted motor will draw extremely high current even under no-load (free-spinning) conditions.

RC12LS is a trademark of ASSOCIATED ELECTRICS, INC.  
©1993 ASSOCIATED ELECTRICS, INC.

# FIRST, A WORD

## ABOUT THE NEW RC12LS

CONGRATULATIONS!! You now have the best 1:12 scale car in the world! The RC12LS has followed along in the winning tradition of all Team Associated 1:12 scale race cars. Starting with the original RC12E, which won numerous National Championships, Associated then designed the RC12i, which won the very first 1:12 scale IFMAR World Championships in Anaheim, California, and then again won the next World Championships in Denmark. The RC12L followed in this winning tradition by taking 1st, 2nd, 3rd, and 5th at the World Championships in Las Vegas, Nevada, including Top Qualifier honors. The original design of the RC12L came from Gil Losi Jr. Gil built the first prototype cars and proved their racing ability. With Gil's participation, Associated further developed the car.

For the 1989 IFMAR World Championships in Singapore we developed a new car. This car, called the RC12LW, was named by our Team Drivers who raced the car. With this car they then went out and won the 1990 IFMAR World Championships in Singapore (winning again at the 1992 IFMAR World Championships in Grand Rapids, Michigan.) The Racers called it the WORLD'S car, hence the official designation RC12LW, or World's car, for short.

The RC12LW varied from the original RC12L in the placement of the weight in both cars. In the RC12LW the weight was shifted and moved closer to the centerline of the cars' chassis. This resulted in a car with more responsive steering, which would become very apparent in the "S" sections of the track. This necessitated a redesign of half of the parts of the car, as well as adding a shock absorber to improve the cars ability to handle rougher tracks.

Did this help the handling of the car? Out Team told us it was a lot better and then went out and took 1st, 2nd and 3rd, as well as Top Qualifier honors, at the IFMAR World Championships in Singapore, and then did a repeat performance, taking all the same honors in Detroit, Michigan.

Our design team of Cliff Lett, Curtis Husting and Roger Curtis has developed a new pivoting a-arm front suspension which we are now including our latest 1/12 scale car which we call the RC12LS ("S" for suspension). This new front suspension improves steering and stability. It is now easier and faster to make changes to the car's front end to adjust for different track conditions. The new front end even adds a new adjustment called caster change which improves steering but also helps reduce tire scrub which will slow down the car. Our Team drivers tell us that the car handles better than ever! Therefore we at Associated feel that we have given you the best 1/12 scale car in the world!

## BEFORE YOU BEGIN

You will find the photos so easy to follow that you may be tempted to put the car together from the photos alone.

However, although you have the best car kit, if you want the best COMPLETED model race car, then you will want to put it together correctly by following these instructions. All that's required is to read the few lines of text near each photo.

**DON'T OPEN ANY OF THE PARTS BAGS UNTIL THESE INSTRUCTIONS TELL YOU**, otherwise the parts will be mixed up and you'll have trouble assembling your car. While building the car, you'll sometimes be working with several parts bags at the same time. These bags are referred to by number in the manual, and the major parts bags are numbered. There are also more bags inside the main parts bags; these are not numbered and belong to the bag they came out of. When you open each main bag for the first time, check the contents against the parts list that came on a separate sheet with your manual. (We have included some spare fasteners and clips, so do not worry when you have parts remaining when you are finished.)

Bags and parts will start multiplying like rabbits as you build, so try and keep the bags separate. One good way is to use large paper plates (picnic plates with partitions are best). Mark the plates with bag numbers and dump the parts into them. When the parts from one bag are used up, you can relabel the plate for another bag. It's easier to find the part you need if it's spread out where you can see it.

**KIT UPDATES.** Team Associated is constantly updating their kits to make sure the customer is getting the best car for their money. The manual is not immediately updated each time, so before you start, look through your kit and see if any of the parts bags have any supplementary instruction sheets in them. If so, locate the section of the manual where it first applies and attach the sheets to that section of the manual so you will not forget about the changes.

**Take your time assembling the car.** Don't race to see how fast you put it together, but put it together well to see how fast you can race. Boxes at each step are provided so you can put a check ✓ mark after you complete each step. This helps when you stop during assembly time, for you will be able to come back and start again in the correct step.

To help you identify certain parts, an outline drawing occasionally will accompany the photo for that step. Just place your part on top of the actual-size drawing to be sure it's the one being referred to.

One final note for you experienced builders and racers: **PLEASE BUILD THE CAR OUR WAY FIRST!** The RC12LS is a remarkably fast car right out of the box. There's a reason for everything on the car, and very few compromises were made in its design. Work with the car first and see what it can do before you experiment or make changes.

Additional notes accompany many steps to help you understand and assemble the kit better. They are in *italics* and preceded by the words **Racer's Tip, Note, Caution,** and **Warning**, and are explained as follows:

**Racers Tip:** *This is a trick used by some of the Team Drivers to improve their cars' handling or reduce its maintenance.*

**Note:** *Helpful tips to tide you over on difficult assemblies.*

**Caution:** *This alerts you to be careful on assembly to prevent use of wrong parts, reduced performance or parts failure.*

**WARNING:** This alerts you to the possibility of injury to yourself or damage to the car or parts.

## ADDITIONAL ITEMS NEEDED TO MAKE THE KIT OPERATIONAL

These items are needed during or after the assembly of your kit:

- 2 Channel R/C surface radio system
- Battery Pack (4 or 6 cell)
- Battery Charger (for 4 or 6 cell battery)
- Electronic Speed Control
- R/C Motor

Motor Pinion Gear (48 pitch) size will be determined by type of motor being used

Fiberglass-reinforced strapping tape (to hold the batteries onto the chassis)

Lexan Body, 1:12 scale size

**TOOLS.** The kit comes with a shock turnbuckle wrench and all the Allen wrenches you'll need, but you will have to supply the following:

- #2 Phillips screwdriver (Associated #SP76)
- Needle-nose pliers
- Side cut pliers (diagonal cutters)
- Hobby knife, such as an X-acto® with a pointed blade.
- File (double cut, smooth is your best choice)

Drill with #43 (2.3mm) drill bit and #34 drill bit. If you cannot find these numbered drill bits you can use a 3/32" drill bit (to replace the #43 drill bit) and a 1/8" drill bit (to replace the #34 drill bit) if you are extremely careful.

Soldering iron (40 to 50 watts) and a small amount of Rosin (not acid) core 60/40 solder. Soldering irons are easier to work with and do a better job than the soldering guns.

The kit can be assembled even easier if you have the following:

3/32" straight Allen wrench with handle. Socket cap Allen screws install much faster and easier with this tool. (Associated "T" handle #SP70).

1/16" straight Allen wrench with handle. Makes installing the flat and button head Allen screws much better.

3/16" nut driver will make installing the ball ends and locknuts easier. (Associated #SP86)

11/32" nut driver makes adjusting the differential easier.

**WARNING! Do not** use a power screwdriver to install screws into nylon parts. The rotation speed is too fast, causing the screws to heat up when being driven into plastic or nylon and they will strip out.

**DO NOT DYE YOUR PARTS.** Normally, because our parts are made of virgin nylon, you can dye our parts. But because of the very tight tolerances being used in making the new front end we DO NOT recommend dyeing these parts. Dyeing causes swelling of the parts, causing binding on the new front end parts and will hurt its performance.

**SAVE THIS MANUAL!** This is more than an instruction manual. It is also a handy supplement to the Team Associated 1:12 scale catalog. You can use the manual to identify part numbers and part names when ordering parts.

**Clear off your workbench,** line up some paper plates, grab a drink and a sandwich, and let's begin!

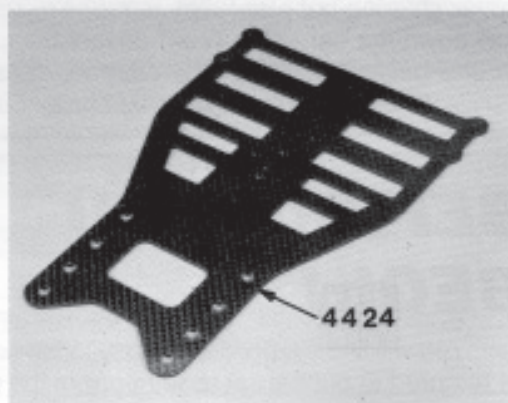
## CHASSIS PREP SECTION

**Figs. 1A & 1B** This RC12LS kit is only offered in a graphite version, but the chassis is still compatible with the #4405 and #4406 RC12LW kits; all three share the same chassis design. Therefore, if you have the RC12LW fiberglass kit you can update your car with the graphite chassis because the basic designs are the same. The same applies to the front end which is also fully interchangeable: the #4400 front suspension kit (with chassis) or #4401 front suspension kit (without chassis) will bolt right onto the graphite and fiberglass RC12LW cars without modifications.

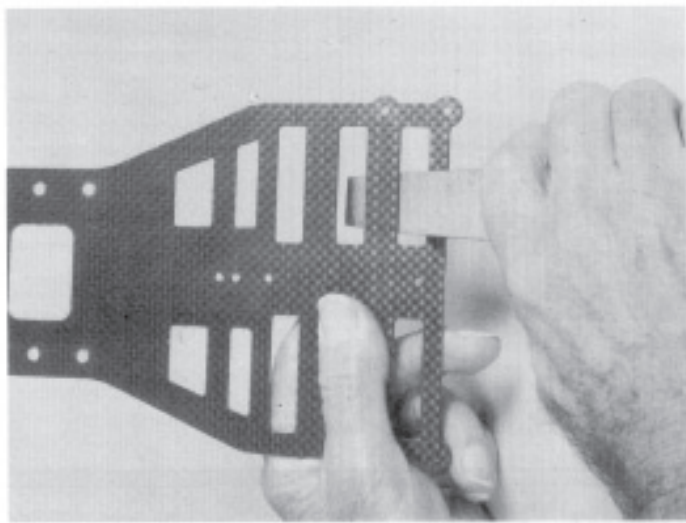
To begin, take your #4424 graphite chassis, and notice that the bottom of the chassis has the holes countersunk for screw heads. On the top of the chassis we want to file the eight rear chassis slot edges at an angle (see Fig. 1B) so the battery cells will not be against a sharp corner which could possibly cut through the battery sleeve (shrink wrap). Lightly file both sides, front and back of the six battery cell slots and the back of the two tape slots just forward of the battery slots. You will also want to file the edges of the chassis where the strapping tape holding the batteries touches the chassis. Just round these corners so they don't cut the tape. Now dip a piece of #280 or #320 grit wet or dry sandpaper into water and smooth all edges of the chassis.

**WARNING!** Graphite dust can be harmful to your health, so make sure that you do the work in a well ventilated location and take proper safety precautions. When you have finished, wash off the chassis with running water and dry it with paper towels. Now wash your hands off with soap and cold water to remove any graphite dust. Carefully dispose of the graphite filings or dust.

You're now finished with Fig. 1A so put a check ✓ mark in the box next to "Figs. 1A & 1B" to show this step is completed. After you have completed each step from now on, check off its box so you know which part of the assembly is completed. You won't miss any steps this way.



**Fig. 1A**



**Fig. 1B**

**Fig. 1C** Because graphite conducts electricity somewhat like metal we have to take some of the same precautions that we would with metal. Because it is conductive we need to make sure that the batteries are properly insulated so that they cannot short out on the chassis. The shrink wrap on the battery cells is an insulator and we have filed the sharp edges off of the chassis so it will not cut through it, but we still need to go one step further. We need to wrap with electrical tape all eight segments of the battery slots where the batteries touch. **Caution:** It is also important to make sure that none of the solder connections can touch the chassis anywhere on the car.

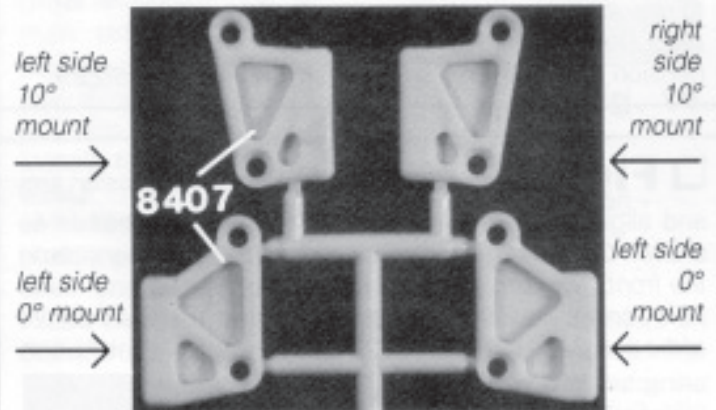


**Fig. 1C**

## FRONT END SECTION

**Fig. 2** Open bag #1, the front end bag, and remove the #8407 front upper arm mounts (see Fig. 2). There are two different types of upper arm mounts as well as left and right mounts. Notice that one side of each mount has two "domes" with holes drilled through the middle. Lay out your upper arm mounts as shown in Fig. 2 with the "domes" facing down.

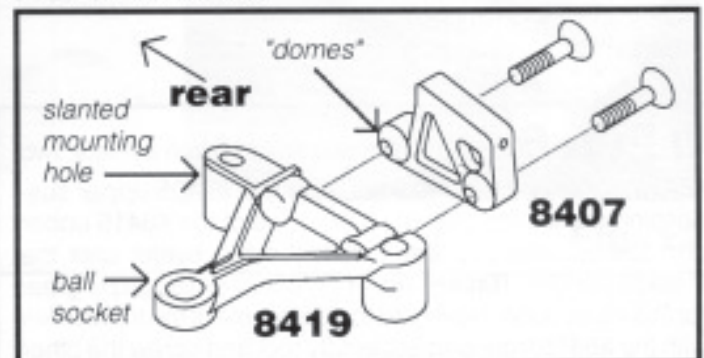
Now locate the right side 10° mount (as shown in Fig. 2) and remove it from the parts tree.



**Fig. 2**

**Fig. 3** From bag #1 remove the right lower suspension arm #8419 and two #8409 4-40 x 1/2" Aluminum FHCScrews. In the master bag you will find the #6950 tool bag which contains the three allen wrenches used to assemble this kit (3/32", 1/16", .050"). To make sure you have the right hand suspension arm, place the lower suspension arm in front of you with the ball socket to the right.

The mounting hole with the slanted top surface will be the rear portion of the suspension arm. Using the two #8409 screws and your 1/16" Allen wrench, screw the #8407 10 degree upper arm mount to the #8419 lower suspension arm. Make sure the "domes" of the upper arm mount will fit into the spaces in the lower arm. Now repeat steps two and three for the left side.

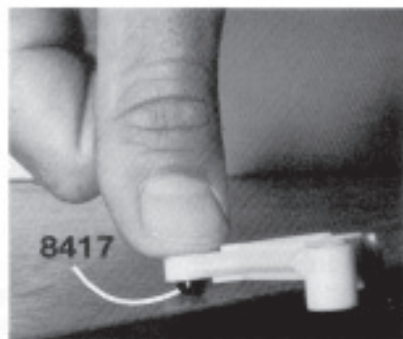


#8409  
4-40 x 1/2  
aluminum

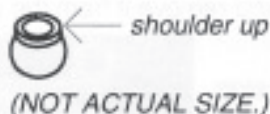
(NOT ACTUAL SIZE.)

**Fig. 3**

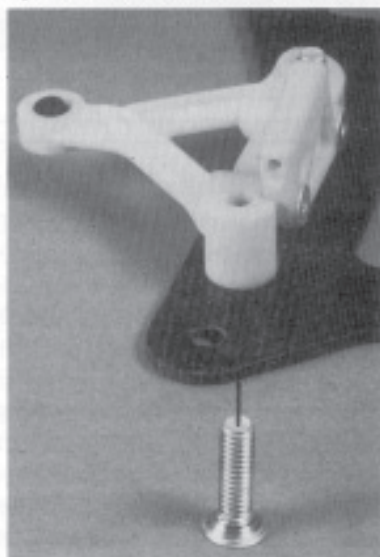
**Fig. 4** Locate two of the four #8417 plastic pivot balls in bag #1. Place one of the #8417 plastic pivot balls on a flat surface, shoulder up, and snap the #8419 arm onto the ball using your thumb. **Caution:** Always install the pivot balls from the bottom of the arms. **WARNING:** Do not use pliers to install the plastic balls. Do the other suspension arm.



**Fig. 4**

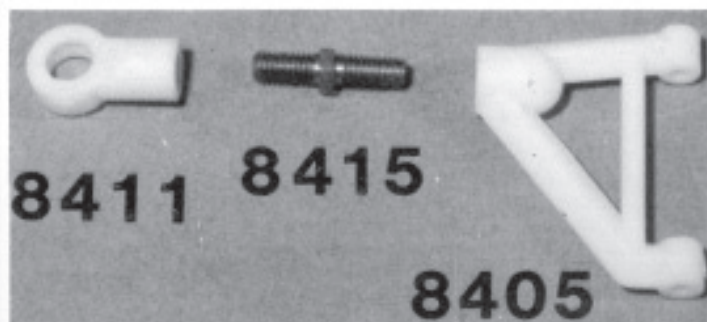


**Fig. 5** Take the #8419 right lower suspension arm and align the arm over the three holes in the chassis as shown. **Caution:** The new chassis has four holes per side on the front. The arm will mount using the second and fourth hole from the front of the chassis. The hole closest to the front of the chassis is the new body mount location. Mount the arm using two #8439 8-32 x 5/8" FHMScrews. Now mount the left lower suspension arm. **Racers tip:** The Team drivers use the supplied #3323 #8 thick aluminum washers as spacers to adjust the front ride height if necessary.

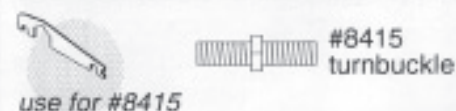


**Fig. 5**

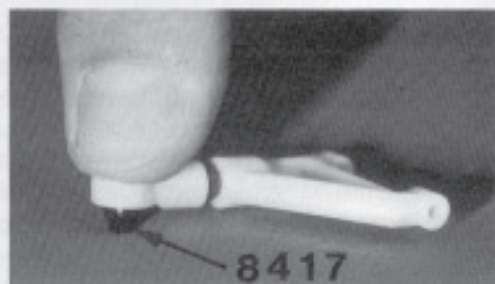
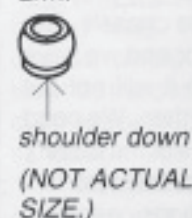
**Fig. 6** Remove the two #8411 nylon eyelets, two #8415 upper arm turnbuckles, and two #8405 upper suspension arms from bag #1. Screw one of the #8415 upper arm turnbuckles into each #8411 nylon eyelet until the threads bottom. **Racers tip:** A 3/16" nut driver helps great for this installation. Now hold the center nut of the turnbuckle with the #8416 front end assembly tool and screw the other end of the turnbuckle into the #8405 upper suspension arm until the threads bottom out. Do the other upper arm assembly.



**Fig. 6**

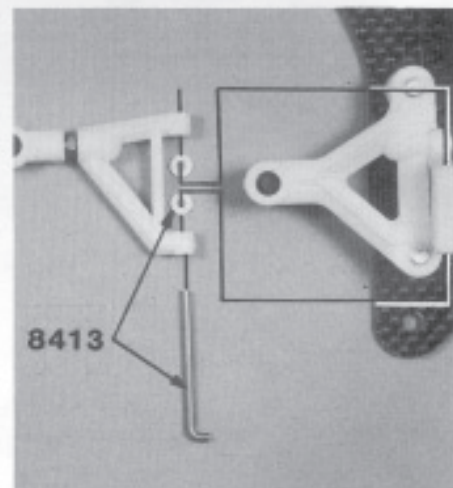
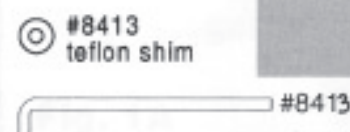


**Fig. 7** Remove the other two #8417 plastic pivot balls from bag #1. Place one of the balls on a flat surface with the shoulder down. Now snap the eyelet onto the plastic ball. **Caution:** Make sure that the ball is always installed from the side of the eyelet with the square edges (not rounded). **WARNING:** Do not use pliers to install the plastic balls. Install second plastic pivot ball in second upper suspension arm.



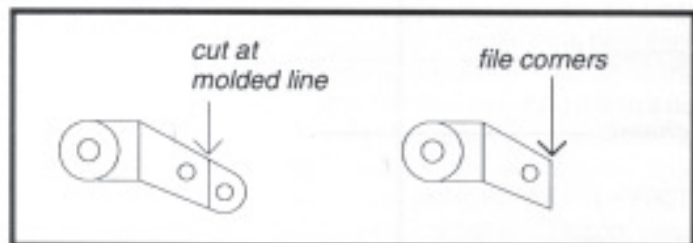
**Fig. 7**

**Fig. 8** Locate the two #8413 upper arm hinge pins and four teflon caster shims in bag #1. We are going to install one of the upper suspension arms to the right upper arm mount. **Caution:** Make sure that the ball end and eyelet is closer to the back of the car than to the front and that the shoulder side of plastic pivot ball is facing down. Slide the #8413 upper arm hinge pin through the arm and arm mount as shown in Fig. 8 making sure that one of the #8413 teflon caster shims is installed on each side of the arm mount. Repeat the process to assemble the left suspension arm.



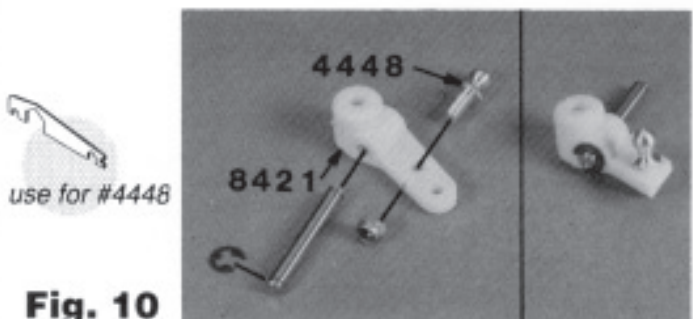
**Fig. 8**

**Fig. 9** In bag #1 you will find the new #8421 front steering blocks. The new blocks have a molded line and two tie rod ball end locations on each one. For the 1:12 scale car we will need to cut the steering block at the mold line as shown in drawing in Fig. 9. After you have trimmed off the steering block you will want to round off the corners using a file or sandpaper.



**Fig. 9**

**Fig. 10** Take two of the #4448 aluminum ball ends and two #4449 4-40 small aluminum locknuts from bag #1. Install one #4448 ball end into the hole on each steering block and thread on a #4449 locknut to secure the ball to the block. The #8416 tumbuckle wrench can be used to install the aluminum ball ends and small locknuts. Make sure that the arm portion of the steering block is down and then install the ball end from the top as shown in Fig. 10. Now from the same bag locate the two #3213 front axles and the small roll of #6299 1/8" E-clips. Install a #6299 E-clip on one end of each axle. Install an axle into each steering block from the back side as shown in Fig. 10. **Note:** The axles will be very snug in each steering block so it will take some force to fully press the axle into the block. Make sure that the E-clip fits snug against the steering block.



**Fig. 10**

before assembly,  
before cutting block

after assembly,  
after cutting block

#4449  
4-40 locknut

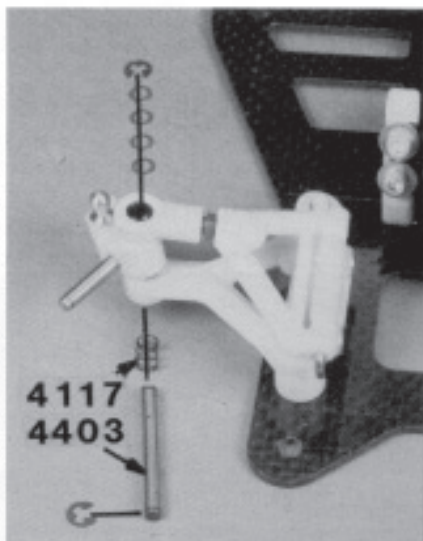
#3213

#4448  
ball end  
aluminum

#6299  
e-clip  
1/8 shaft

**Fig. 11**

Locate the two #4403 kingpins, the two #4117 .022 springs, and the eight #8425 steel shims in bag #1. Install a #6299 E-clip on each kingpin. Slide a #4117 spring onto each kingpin. We want to insert the kingpin and spring through the right lower arm pivot ball (from the bottom) then through the steering block and finally through the upper arm pivot ball. Install four #8425 steel shims to the end of the kingpin on top of the upper arm pivot ball. Secure with a



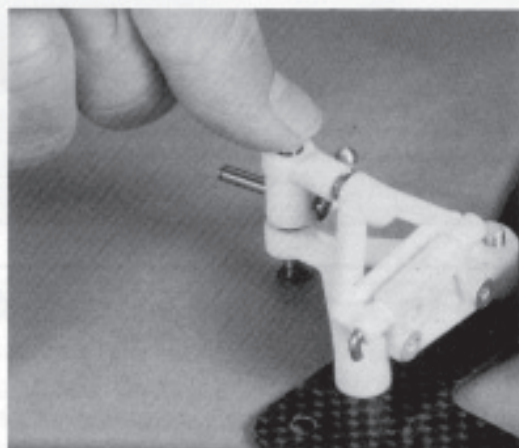
**Fig. 11**

#8425 steel shim #6299 e-clip 1/8 shaft

#4403

#6299 E-clip. **Caution:** Make sure that the shoulders on both the upper and lower pivot balls are making contact with the steering block and that the steering block arm is on the bottom (closer to the lower arm) with the ball end facing up.

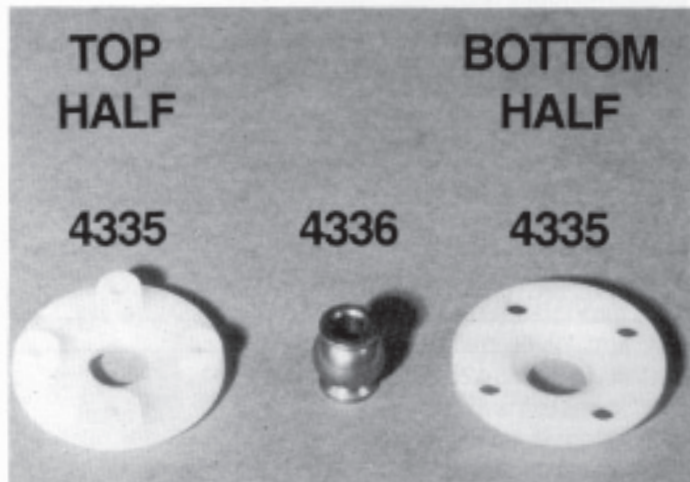
**Fig. 12** Using your thumb push down on the top of the kingpin so that all of the free play is taken up on the spring side of the kingpin. Now go back and install the kingpin in the left side suspension arm.



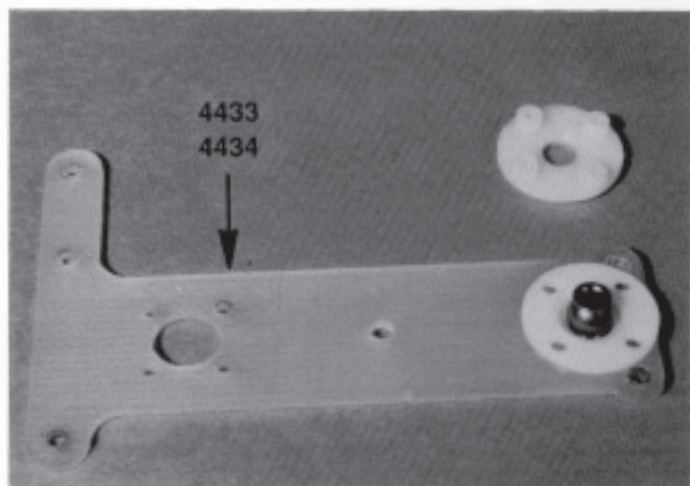
**Fig. 12**

## T-BAR SECTION

□ **Figs. 13A & 13B** From bag #3 locate two #4336 steel pivot balls and the four #4335 plastic pivot socket pieces. Place the steel pivot ball inside one half of the ball socket and then place the other half of the ball socket over the ball.



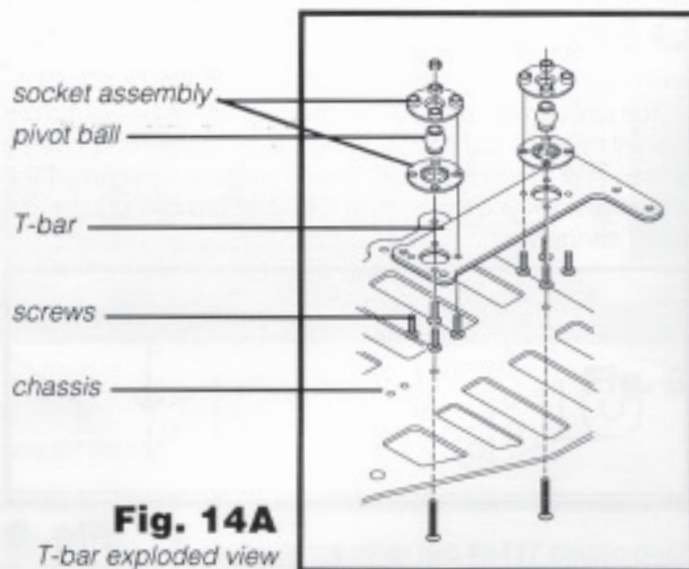
**Fig. 13A**



top side shown

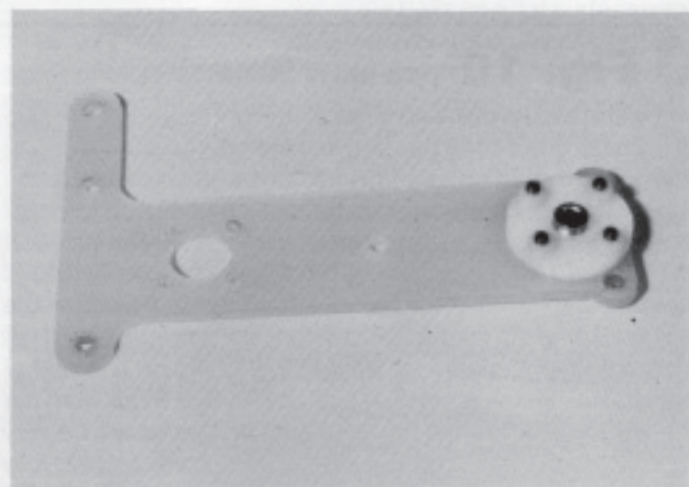
**Fig. 13B**

□ **Figs. 14A, 14B & 14C** From bag #3 locate the #4433 .063 T-bar and #4434 .075 T-bar (the .063 is your best choice to start with), and eight #4334 2-56 x 5/16" BHSScrews (pivot socket screws). Lay the #4433 or #4434 T-bar down so that the long leg is on the left side. Take one of the pivot ball and socket assemblies and install it on top of the forward end of the T-bar. One half of the socket is designed to fit in the large hole in the T-bar. Using four of the #4334 screws, mount the pivot socket to the T-bar from the bottom of the T-bar. Be careful not to overtighten the mounting screws. If this ball is tight in the plastic socket, it's okay, it's not supposed to swivel.



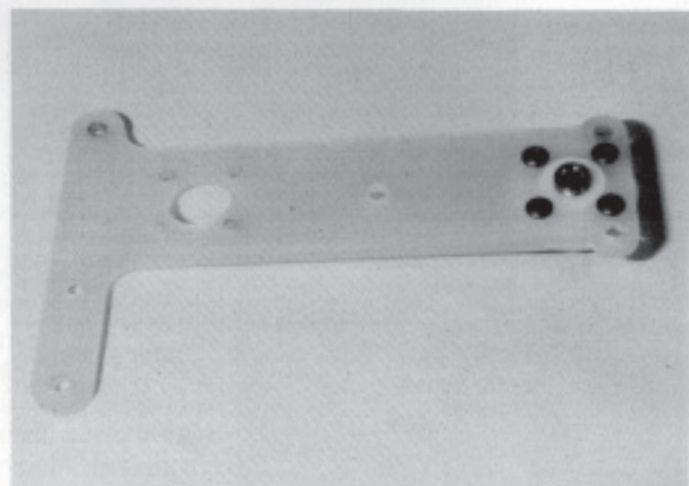
**Fig. 14A**

T-bar exploded view



#4334 top side shown  
2/56 x 5/16

**Fig. 14B**



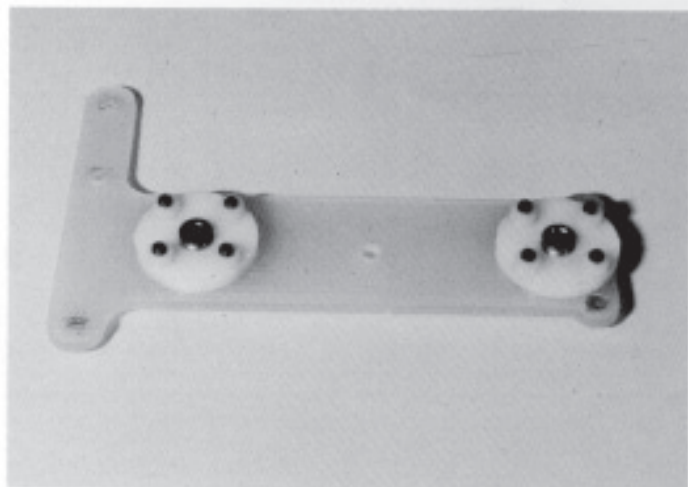
bottom side shown

**Fig. 14C**



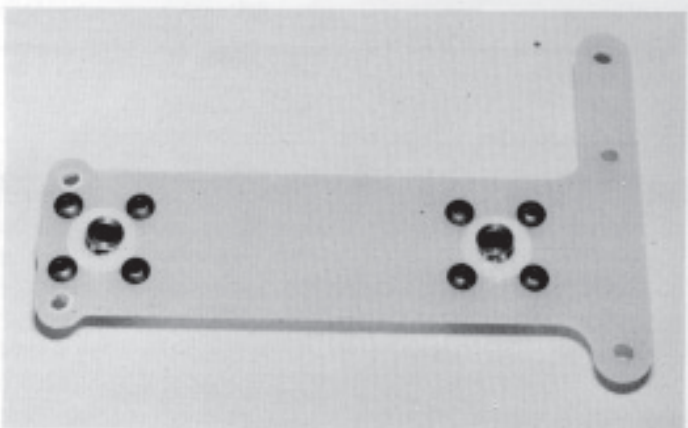
□ **Figs. 15A & 15B** Now we are going to assemble and mount the second rear pivot socket assembly, like you did the first, EXCEPT in this socket, the ball MUST BE VERY FREE, BUT NOT LOOSE. Go ahead and install the second pivot ball socket assembly following the instructions in Fig. 14. Now see if the ball is PERFECTLY FREE. If it is, good, leave it as is.

If it's not there are two things you can do. You can unscrew all four screws one quarter turn. But the best thing to do is to take the ball back out and polish it. You can do this by placing a 4-40 screw in the ball and securing it with a nut and turning the screw in a drill press, and then polish the ball with crocus cloth or #660 wet or dry sandpaper. Now recheck the fit of the ball until the ball is PERFECTLY FREE, but NOT LOOSE. These figures show top and bottom views of the T-bar with the forward pivot ball assembly installed.



top side shown

**Fig. 15A**

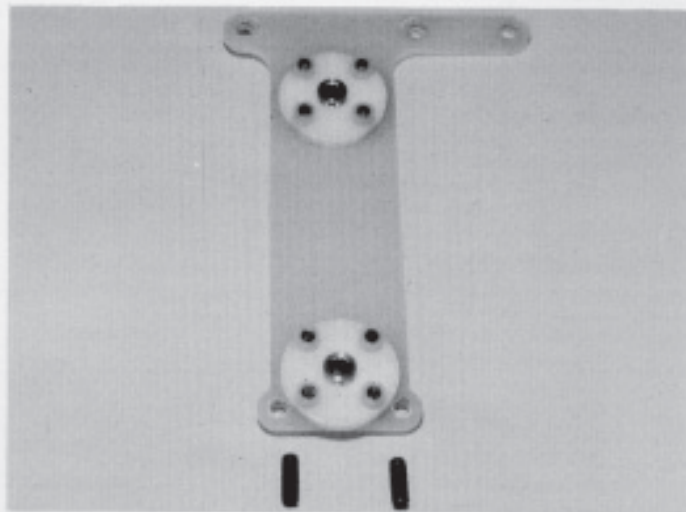


bottom side shown

**Fig. 15B**

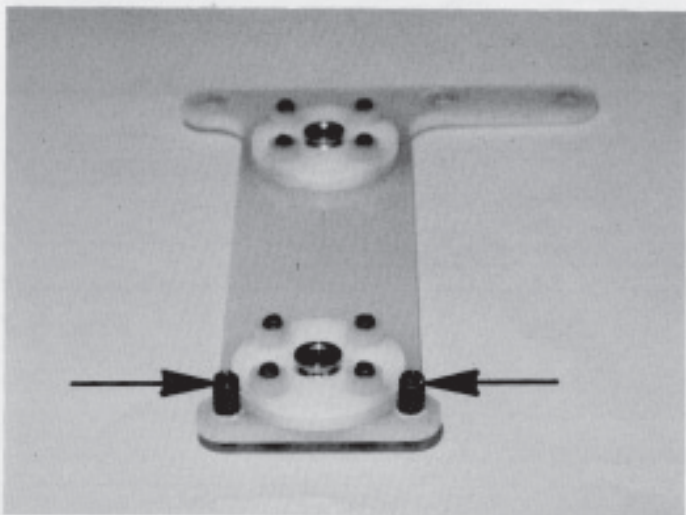
□ **Figs. 16A & 16B** Locate the two #4436 4-40 x 5/16" set screws in bag #3. Install the two set screws into the front of the T-bar from the top as shown in Fig. 16A. Just screw them in far enough so they just start to come through the bottom side, but NO MORE.

The two set screws you've just installed are called TWEAK SCREWS. These are VERY IMPORTANT. We'll be coming back and adjusting these after the car is completely assembled.



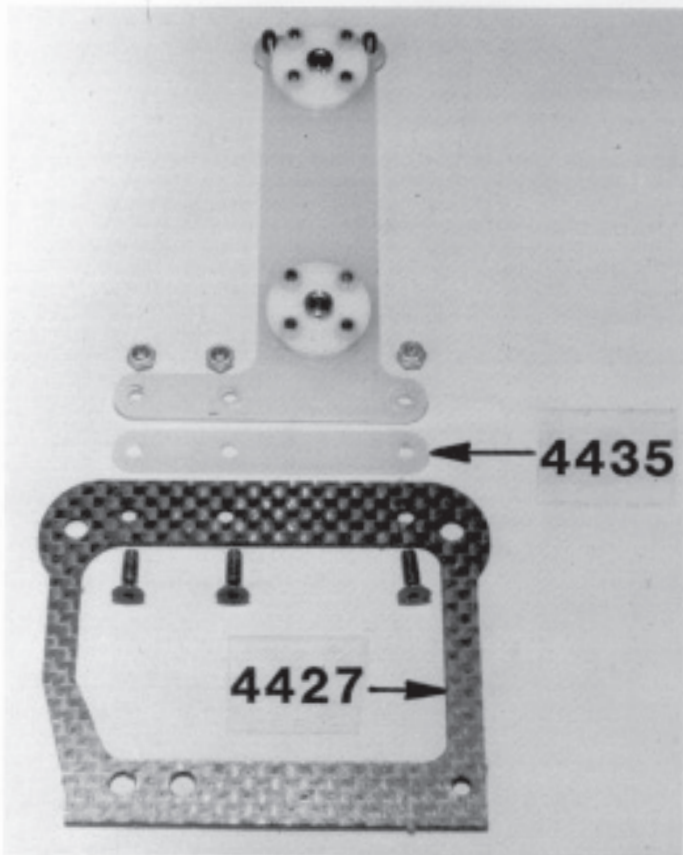
#4436  
4-40 x 5/16  
Allen screw

**Fig. 16A**



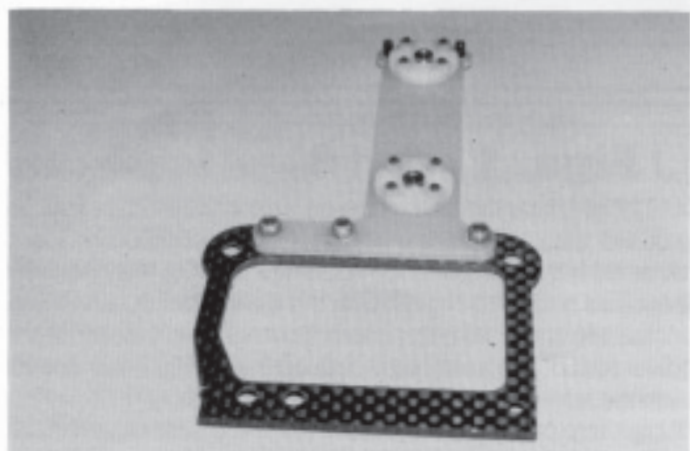
**Fig. 16B**

□ **Figs. 17 & 18** In bag #4 you will find the #4427 graphite lower rear brace and #4435 T-bar spacer. You will also find three #6292 4-40 x 3/8" FHSScrews and three #4449 small aluminum locknuts. Layout the lower rear brace as shown in Fig. 17 with the countersunk side down. Install the three #6292 screws through the bottom of the lower rear brace as shown. Line up the #4435 T-bar spacer with the screws and install over the screws and on top of the T-bar. Now slide the T-bar down over the screws and install and tighten the three #4449 small aluminum locknuts onto the screws. Your completed assembly will look like Fig. 18.



**Fig. 17**

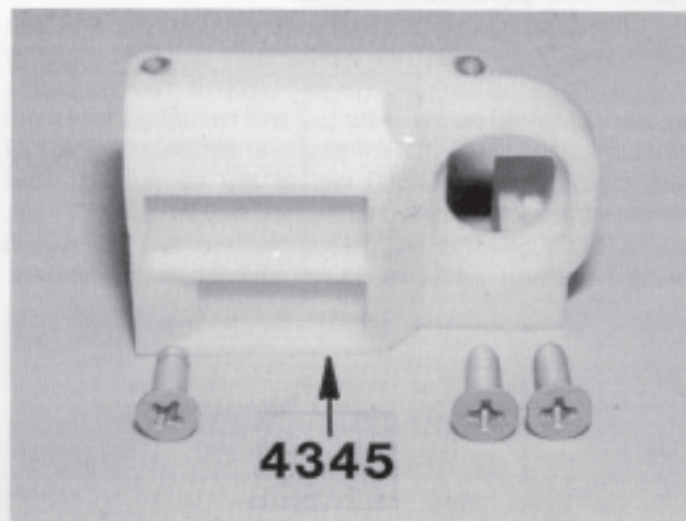
#6292 4-40 x 3/8 #4449 4-40 locknut



**Fig. 18**

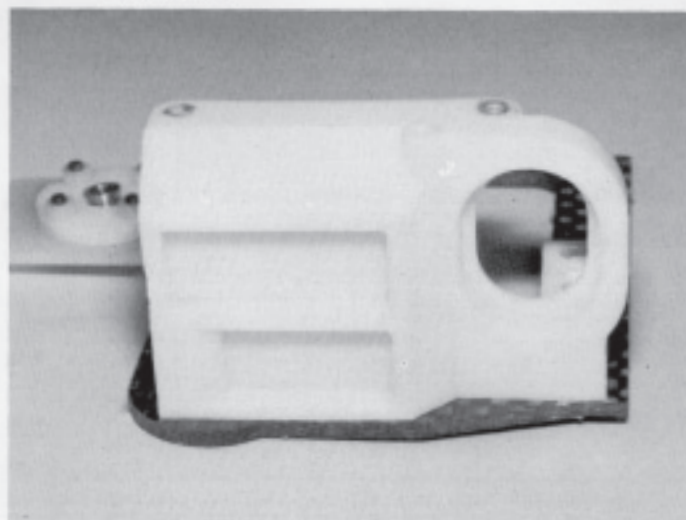
## REAR END

**Figs. 19 & 20** In bag #4 you will find the #4345 left nylon rear bulkhead and three #3324 8-32 x 1/2" FHMScrews. Install the left hand bulkhead onto the lower rear brace using the three #3324 screws. Do not overtighten.



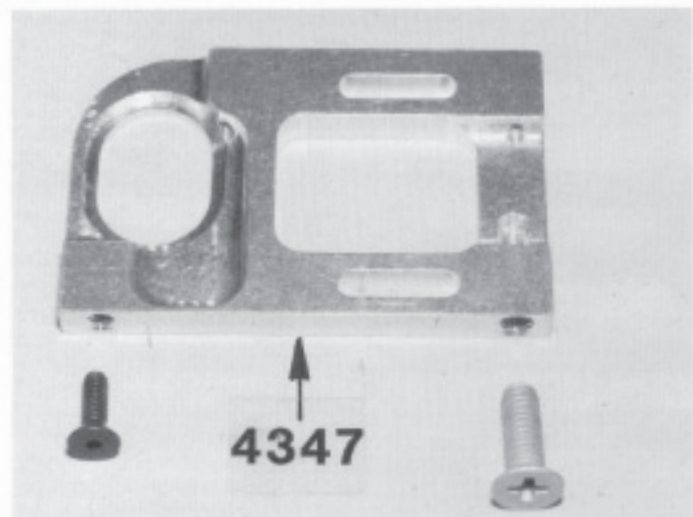
**Fig. 19**

#3324 8-32 x 1/2 aluminum



**Fig. 20**

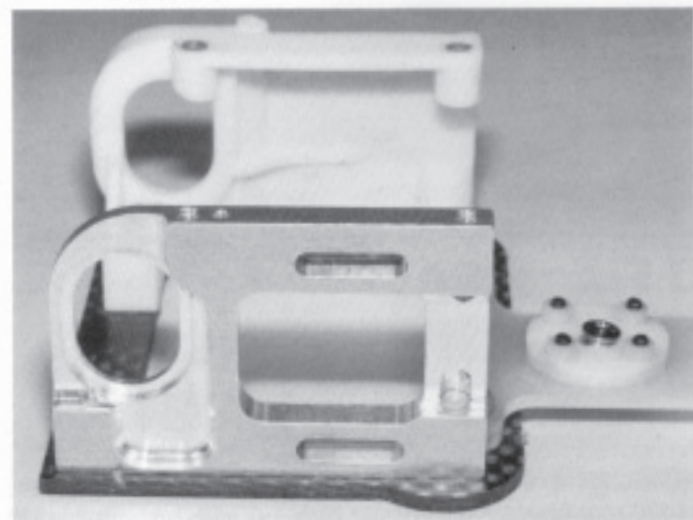
**Figs. 21 & 22** Remove the #4347 aluminum motor bulkhead from bag #4. In the same bag you will find one #3324 8-32 x 1/2" aluminum FHMScrews and one #6292 4-40 x 3/8" FHCScrews. Mount the #4347 motor bulkhead to the lower rear brace using the #3324 and #6292 screws. *Racers Tip: A drop of shock oil on the #3324 aluminum FHMScrews will guarantee that you do not have any problems when it comes time to remove this screw from the aluminum bulkhead.* Fig. 22 shows the motor bulkhead mounted.



#3324  
8-32 x 1/2  
aluminum

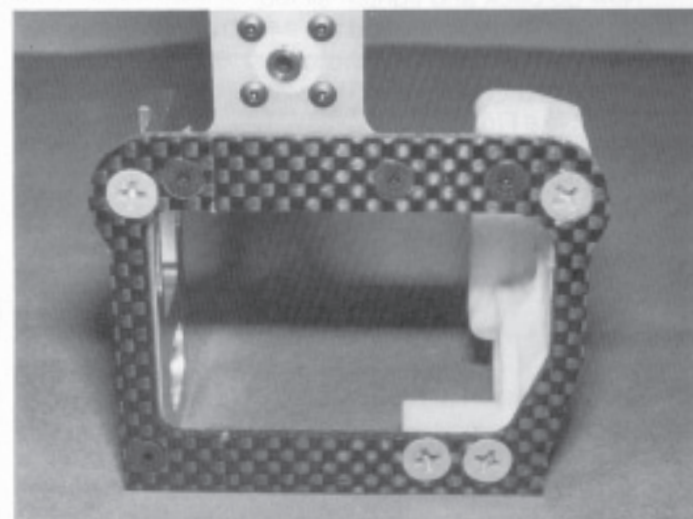
#6292  
4-40 x 3/8

**Fig. 21**



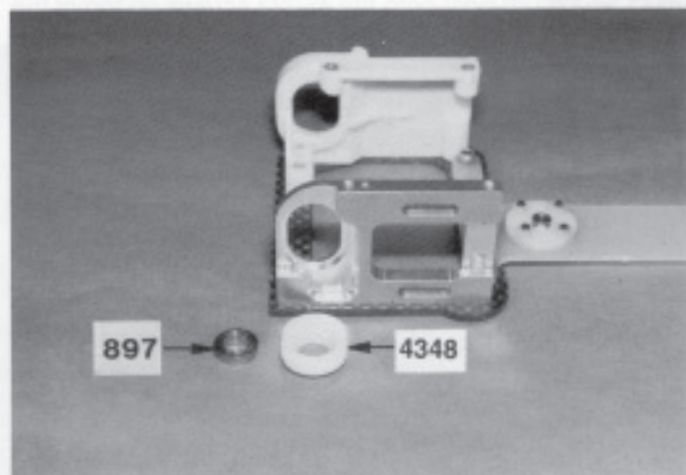
**Fig. 22**

**Fig. 23** The bottom of your completed rear end assembly should look like this.

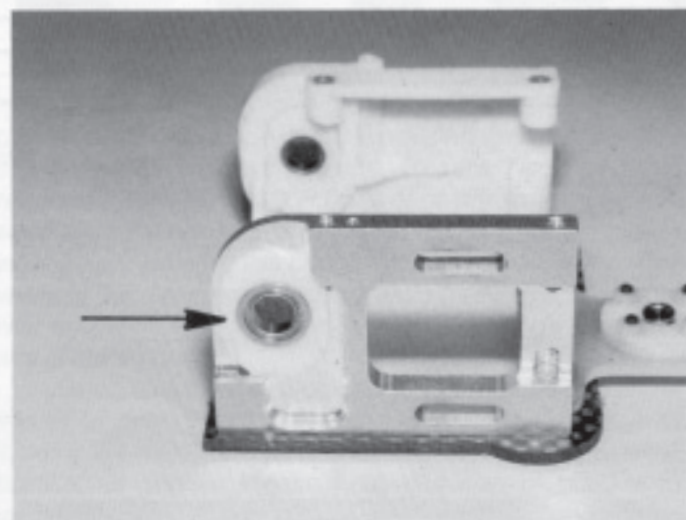


**Fig. 23**

**Figs. 24 & 25** In bag #4 you will find three sets of plastic axle bearing height adapters (#4348, #4349, & #4350). Locate the #4348 height adapters (ones with three small little dots on the back side and with the ball bearing holes centered in the adapter). Install one of the adapters in each rear bulkhead. In the master bay you will find the separate bearing bag which has the eight kit bearings in it. Take two of the larger #897 1/4" x 3/8" flanged bearings and install one into each bearing adapter.



**Fig. 24**




#897  
1/4 x 3/8  
flanged bearing

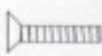
**Fig. 25**

**□ Figs. 26, 27 & 28** Now we are ready to install the rear end assembly onto the chassis. Slip the short #6922 4-40 x 1/2" FHC Screw (from bag #4) up through the forward T-bar mounting hole (second hole from the back), then slip the T-bar down onto the screw. Now install the #4449 4-40 small aluminum locknut and tighten. In the same bag you will find one #6923 4-40 x 3/4" FHC Screw. Install this through the rear chassis hole and pivot ball from the bottom. In bag #3 you will find the #4441 aluminum lower dampener post and #4440 4-40 x 1/2" set screw. Thread the #4441 aluminum post onto the #6923 screws on top of the T-bar, and tighten the screw. Now screw a little less than half of the #4440 set screw into the aluminum tube as shown in Fig. 27. Fig. 28 shows the completed T-bar and rear pod assembly installed.




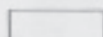
**Fig. 26**

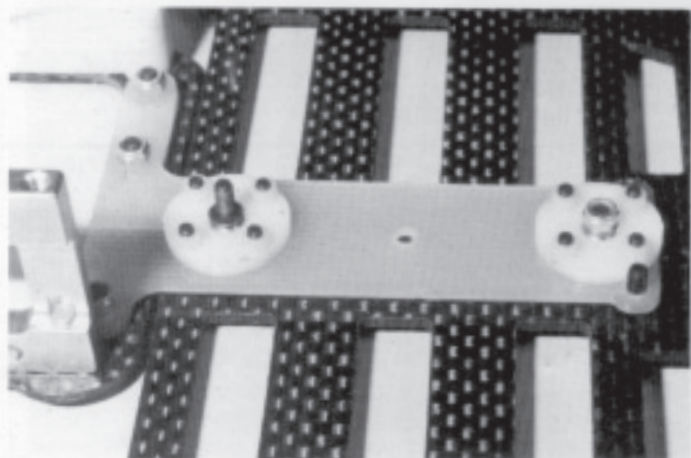
 #4449  
4-40 locknut

 #6922  
4-40 x 1/2

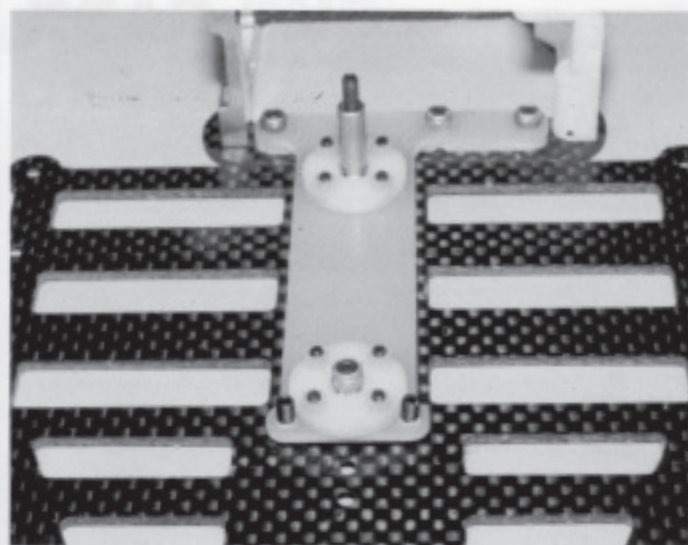
 #6923  
4-40 x 3/4

 #4440  
4-40 x 1/2  
set screw

 #4441



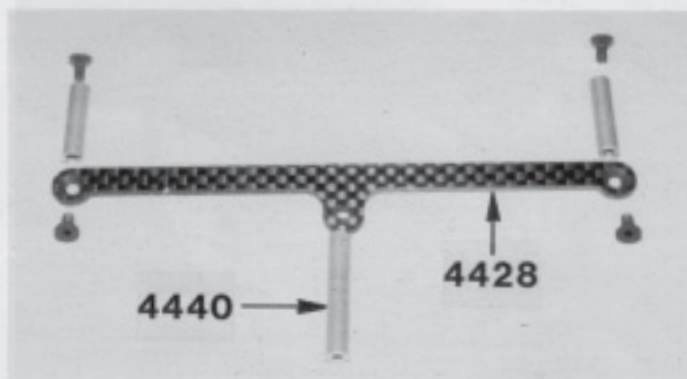
**Fig. 27**




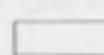
**Fig. 28**

**□ Figs. 29A, 29B & 30** In bag #5 find the #442B graphite rear chassis brace. In the same bag you will find two #4442 aluminum chassis brace standoffs, one #4440 upper dampener tube, and four #6292 4-40 x 3/8" FHC Screws. Install the #4442 chassis brace standoffs to the two rear holes in the chassis (as shown in Fig. 29B) using two #6292 screws. Do not tighten the screws yet. Slip the #442B rear chassis/dampener brace down over the #4441 long set screw on top of the T-bar. Make sure the counter-sunk side is up and the flat edge of brace is to the rear. Take the remaining two #6292 screws and secure the brace to the #4442 standoffs using the outer holes on the ends of the brace.

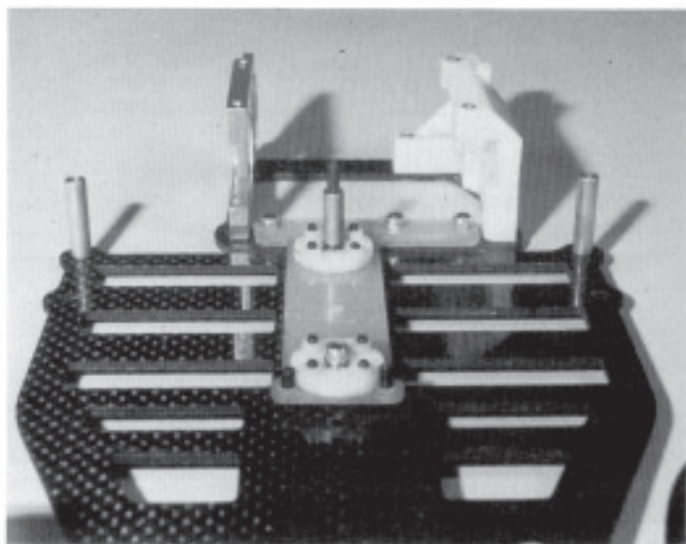
Now go back and tighten all four screws holding the brace to the standoffs. Thread the #4440 upper dampener tube onto the set screw, in the center of the brace, and tighten down with your pliers. The completed brace assembly will look like Fig. 30.



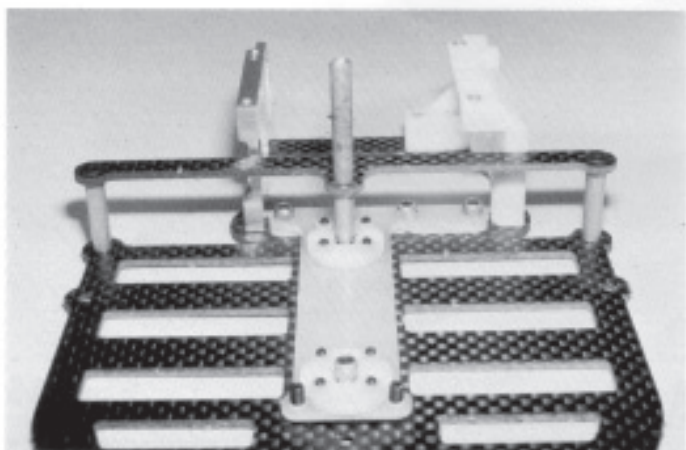
 #6292  
4-40 x 3/8

 #4442

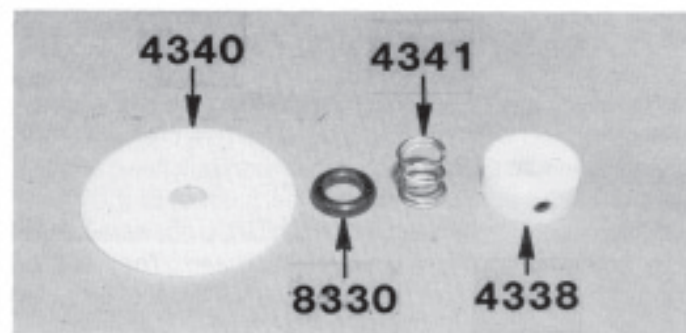
**Fig. 29A**



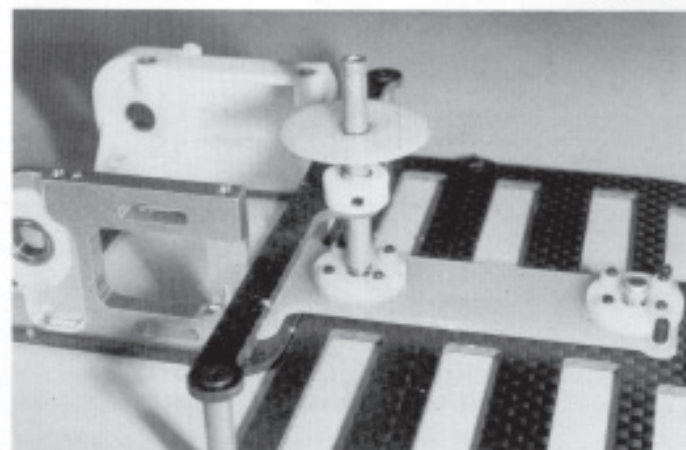
**Fig. 29B**



**Fig. 30**



**Fig. 31**



**Fig. 32**

**Figs. 31 & 32** Take the two #8330 black o-rings and two #4340 plastic dampener washers out of bag #6. Install one #8330 black o-ring in the top of each #4340 plastic dampener washer. From the same bag remove the one #4338 nylon locking collar, one #6951 4-40 x 1/8" set screw, and one #4341 dampener spring. Screw a #6951 set screw into the #4338 nylon locking collar. Now install the #4338 locking collar over the #4440 dampener tube, next install one #4341 dampener spring and #4340 plastic dampener washer with #8330 o-ring installed. Install the dampener washer with the o-ring side down and the smooth side up.

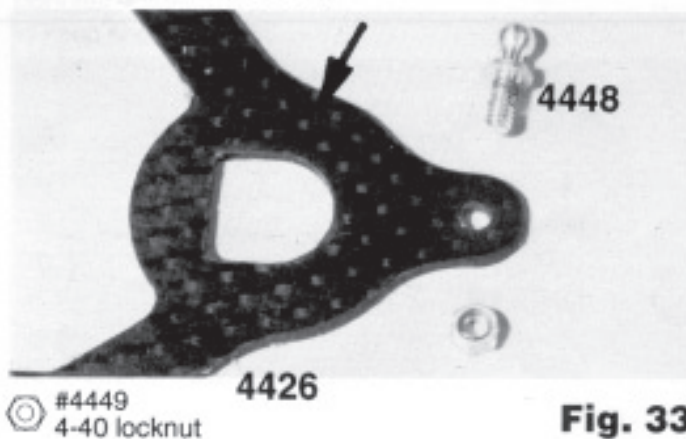
#6951 set screw

 #8330 black O-ring

 #4341 spring

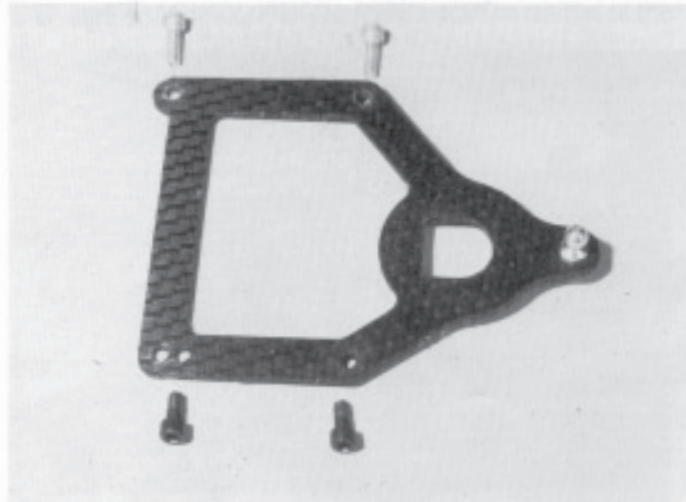
**Fig. 33** Take the #4426 upper rear bracket from bag #4. The arrow in the photo is pointing to the area where the dampener washers will ride. **Racers Tip:** The Team racers will take some #600 grit wet or dry sandpaper and sand all of the edges smooth around where the dampener washers will ride. Do this on the top and bottom sides. This will help the dampener washers slide freely over the upper rear bracket. Clean the bracket and your hands to remove any graphite dust.

Open bag #7, the shock bag, and remove one of the #4448 aluminum ball ends and one #4449 small 4-40 locknut. We want to install it in the top of the #4426 upper rear bracket as shown. Please note direction of bracket to identify top side. Install the #4449 small locknut and tighten from the bottom of bracket.



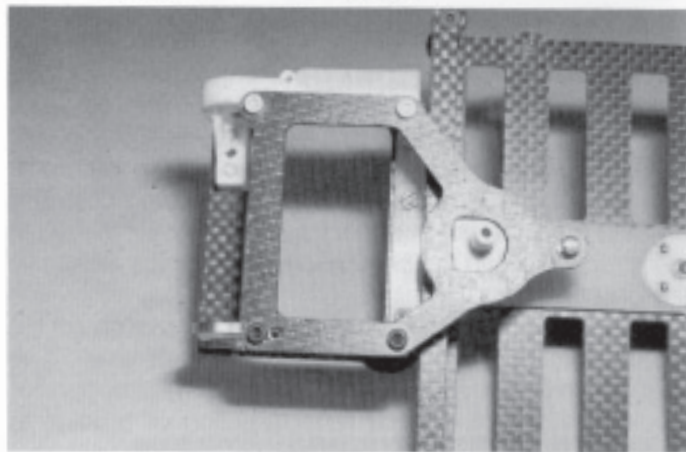
**Fig. 33**

❑ **Figs. 34A & 34B** In bag #4 you will find two #6285 4-40 x 1/4" SHCScrews and two #4145 4-40 x 5/16" aluminum SHCScrews. Place the #4426 upper rear bracket on top of the rear bulkheads. Use the two #4145 screws to mount the bracket to the nylon bulkhead and use the two #6285 screws to mount the bracket to the #4347 aluminum motor bulkhead. **WARNING!** Do not install aluminum screws into the aluminum bulkhead. They will be impossible to remove or fasten securely. Do not overtighten the screws.



#4145 4-40 x 5/16 aluminum  
 #6285 4-40 x 1/4 steel

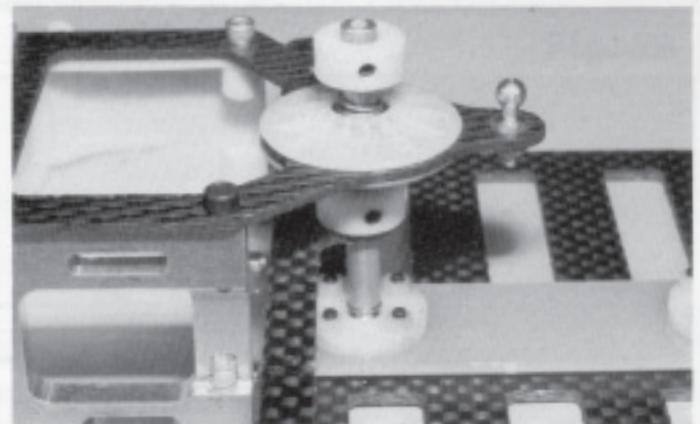
**Fig. 34A**



**Fig. 34B**

❑ **Fig. 35** Go back to bag #6 and take the second #4340 plastic dampener washer, with the #8330 black o-ring installed, and install it over the upper rear brace with the smooth side down and o-ring side up. In the same bag you will find the second #4341 dampener spring and #4338 nylon locking collar and #6951 4-40 x 1/8" set screw. Thread the #6951 set screw into the #4338 nylon locking collar. Install the #4341 dampener spring over the post on top of the o-ring and then install the #4338 locking collar with #6951 set screw on top of the aluminum tube and tighten down the set screw.

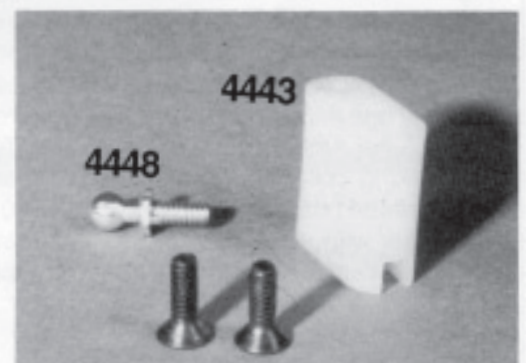
Measure the spacing between the lower locking collar and the lower dampener washer then adjust the upper locking collar so the spacing is the same between the upper collar and dampener washer. Equal spacing on the top and bottom will help make the car more consistent.



#4341 spring  
 #6951 set screw

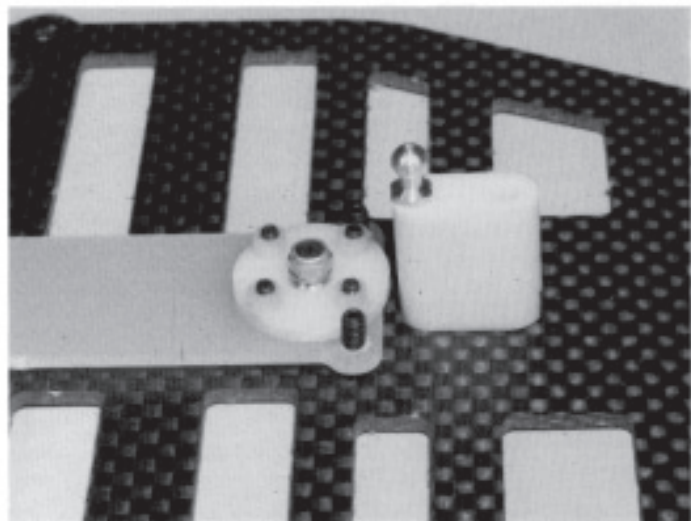
**Fig. 35**

❑ **Figs. 36 & 37** In bag #7 you will find the #4443 antenna/shock mount, one #4448 aluminum ball end, and two #6292 4-40 x 3/8" FHCScrews. We are going to install the #4448 aluminum ball end in the top of the antenna mount. The bottom of the mount is notched out on one end for the antenna wire which enters on the bottom front of the mount. The ball will mount on the top back hole (the small hole by itself) as shown in Fig. 36. Now take and install the antenna mount to the chassis using the two #6292 screws. Make sure that the larger hole in the mount is to the front with the notched side down. Fig. 37 shows the mount installed on the chassis.



#6292 4-40 x 3/8

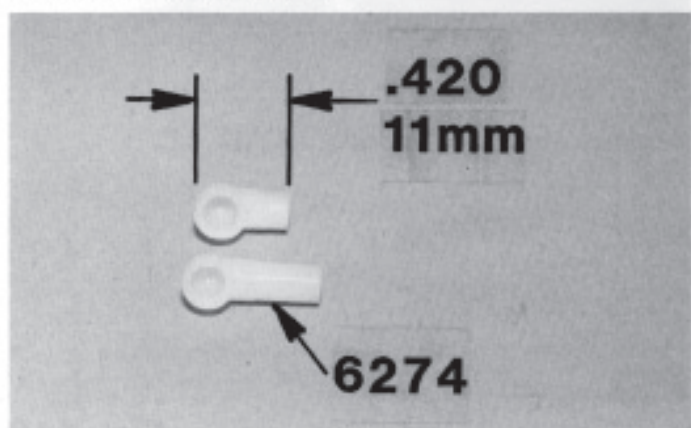
**Fig. 36**



**Fig. 37**

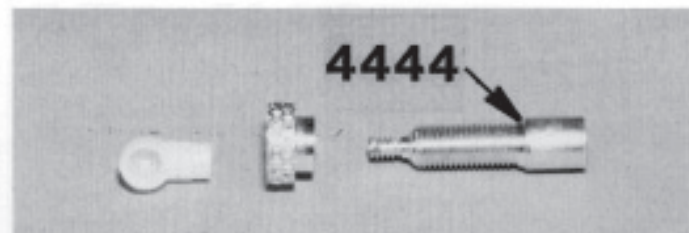
## SHOCK ASSEMBLY

**Fig. 38** In bag #7 you will find two #6274 plastic ball cups. You will need to take your X-acto® knife and shorten both plastic ball cups to an end to end measurement of .420" or 11mm as shown.

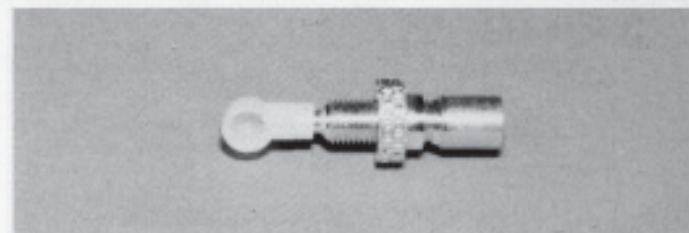


**Fig. 38**

**Fig. 39 & 40** Now we will begin assembly of the Delta Shock. **Note:** Associated does not have individual replacement shock parts for the Delta shock to sell unless the part has an Associated part number in the instructions. Remove the Delta shock body and spring adjusting collar from bag #7. Screw the spring adjustment collar onto the shock body as shown in Fig. 40. Make sure that the stepped end goes on first and the knurled end is closer to the small end. Thread the collar all the way on until it bottoms out and then back it off two full turns. Now take one of the #6274 plastic ball ends that we modified in Fig. 38 and screw it all the way onto the small threaded end of the shock body. Fig. 40 shows your shock assembled to this point.

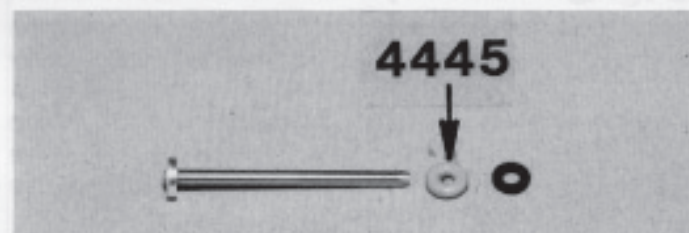


**Fig. 39**



**Fig. 40**

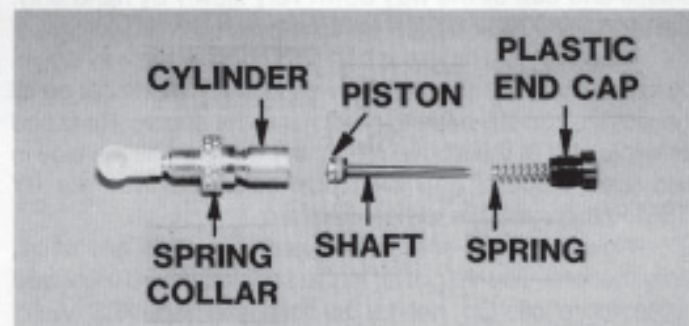
**Fig. 41** Take the #4445 red o-ring from bag #7 and slide it onto the shock piston/shaft. In the same bag you will find a small brass washer, trim off any flashing and slide it onto the shock piston/shaft behind the #4445 red o-ring.



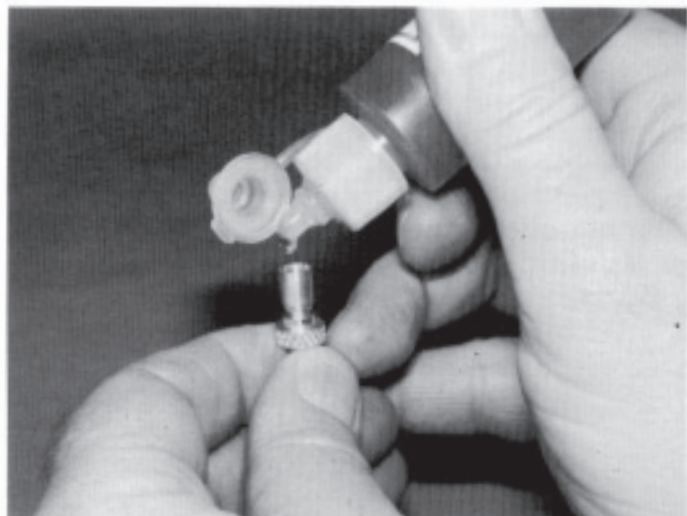
#4445 red O-ring

**Fig. 41**

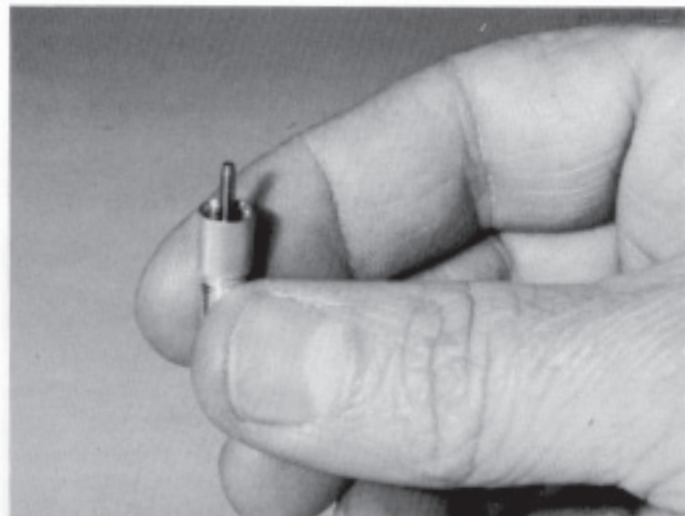
**Figs. 42 & 43** In bag #7 you will find the small internal shock spring and black plastic end cap. Insert the spring into the threaded end of the end cap. Using Fig. 42 as a guide, we are going to assemble the rest of the shock. First hold the shock body so that it's almost upright, as in Fig. 43, but still at a slight angle. Put shock oil in SLOWLY, letting it run down the inside wall to prevent air bubbles. Fill with oil to the BOTTOM of the threads. Be sure to keep shock upright.



**Fig. 42**



**Fig. 43**



**Fig. 44A**

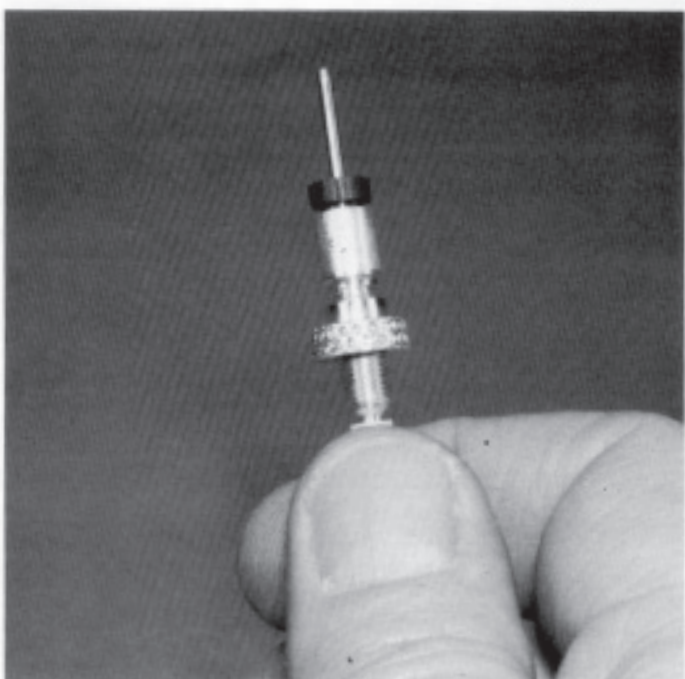
**□ Figs. 44A, 44B & 45** Take the piston/shaft assembly and slowly push it down into the shock body. We are being careful not to create any air bubbles or lose any oil. Trim any flash off the end of the black plastic end cap. Now slip the spring and black plastic end cap onto the shock shaft. **BE CAREFUL HERE.** Screw the black plastic end cap assembly only two turns into the cylinder, **SLOWLY.**

Now we must bleed the shock. **THIS IS A VERY IMPORTANT PROCEDURE.** There's no quick, easy way. It'll take a few minutes. Refer to Fig. 45. Push the shaft in very slowly. We want to be able to push it all the way to the bottom. However, if there's too much oil in it, the shaft will not go all the way to the bottom. If you find there is too much oil, unscrew the cap while pushing the shock shaft in. It might be necessary to bleed some of the oil out. We are talking about a very small amount of oil here; less than one drop. If you've unscrewed the cap all the way, then you can push the shaft all the way in, then re-install the plastic end cap two turns. Now push the shaft in again to check it. See if it will now go all the way to the bottom. If not, then repeat the above steps. If it does, hold the shaft in and screw the plastic end cap all the way down very slowly by hand only.

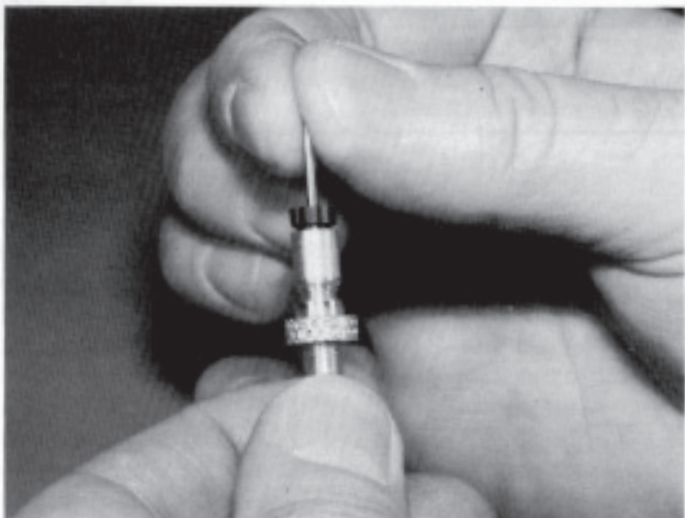
**Caution: DO NOT USE A WRENCH!**

Now that you have the cap tightened all the way down, by hand, push the shaft all the way in. If it still will not go all the way in, you still have too much oil in the shock. Re-bleed as explained in the above steps. If it does go all the way in and feels smooth, and then pushes all the way out **BY ITSELF**, then you are almost finished.

Now move the shaft in and out. If you feel any small, jerky motions, you've got air in the shock and you must add some more oil. Do not try to rush this job. **IT'S VERY IMPORTANT THAT IT BE DONE CORRECTLY.**



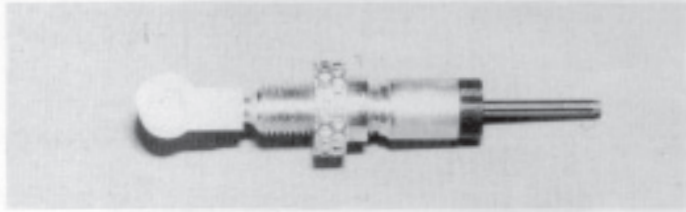
**Fig. 44B**



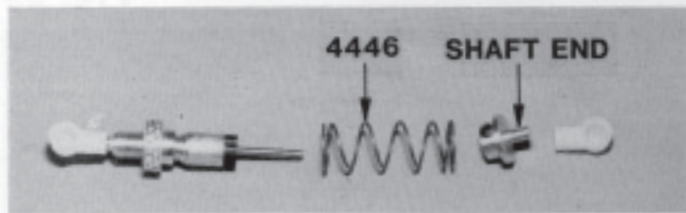
**Fig. 45**



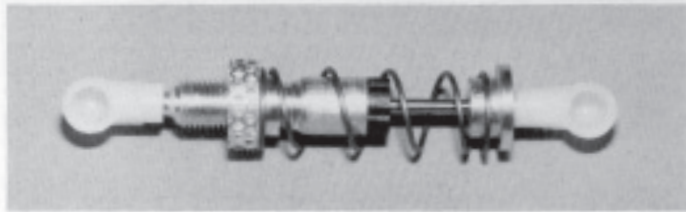
❑ **Figs. 46, 47 & 48** Remove the #6951 4/40 x 1/8" set screw and aluminum shock shaft end from bag #7. Thread the #6951 set screw into the aluminum shock shaft end then take the other #6274 plastic ball end, that we modified back in Fig. 38, and screw it onto the aluminum shock shaft end. Take the #4446 shock spring from bag #7 and install it onto the shock. While holding the spring collapsed, install the aluminum shock shaft end onto the shock shaft and securely tighten the #6951 set screw.



**Fig. 46**

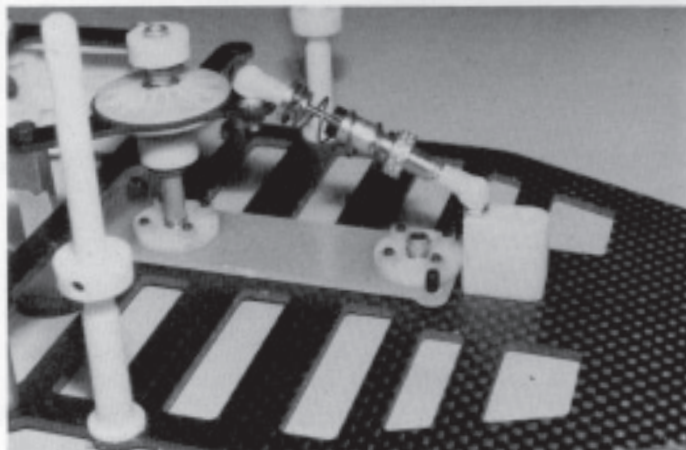


**Fig. 47**



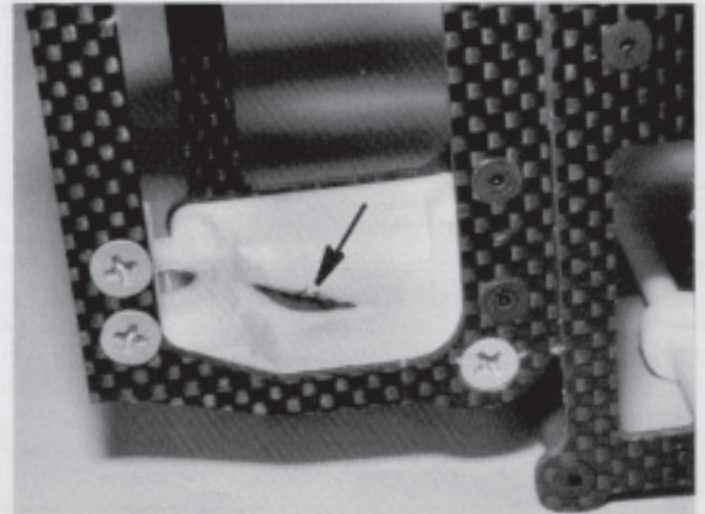
**Fig. 48**

❑ **Fig. 49** Snap the shock on to the aluminum ball ends on the antenna/shock mount and upper rear bracket. Make sure that the adjusting nut side of the shock is closer to the antenna shock mount as shown.

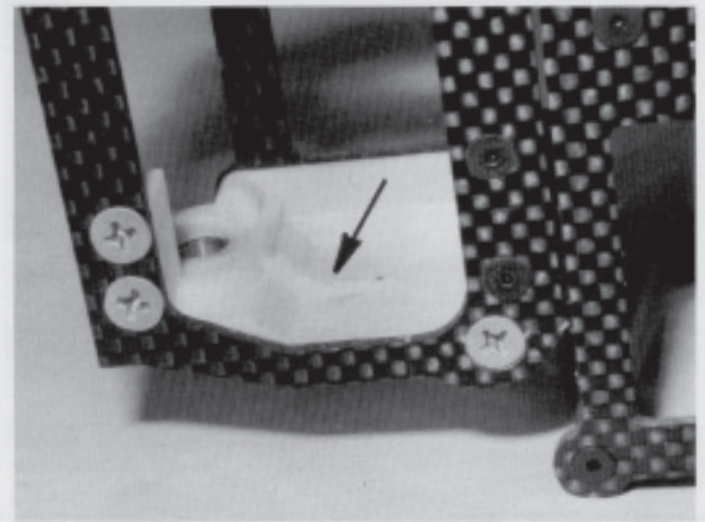


**Fig. 49**

❑ **Figs. 50 & 51** We will need to trim or grind away some of the plastic from the left hand bulkhead where shown in Fig. 50. Use an X-acto® knife or Dremel® tool and trim off approximately 1/8" of material, as shown. When finished your left hand bulkhead should look like Fig. 51. This will allow us to install and remove the motor with less problems.



**Fig. 50**

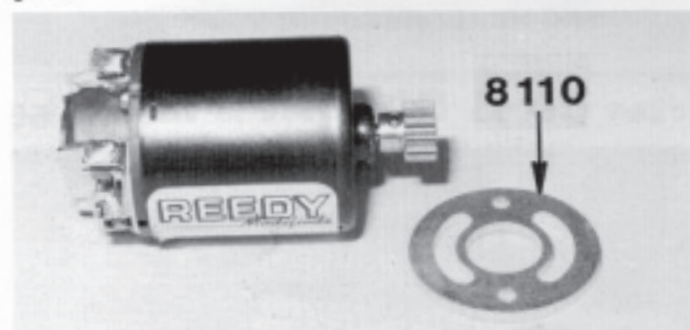


**Fig. 51**

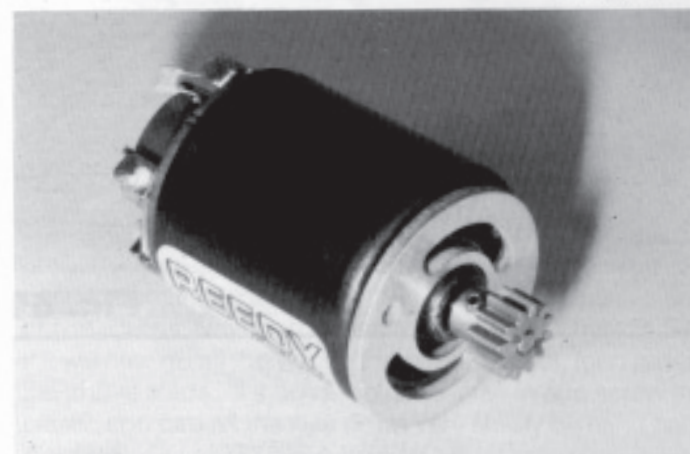
❑ **Figs. 52 & 53** Before you install your motor, install the capacitors as per your speed control and/or motor manufacturers' specifications to help prevent radio interference. **Note:** If you have a HIGH FREQUENCY electronic speed control, Reedy Modifieds has an effective #745 Schottky diode for your motors which will improve the reliability of your speed control. You will find more information on this in the tuning and tips section at the end of the manual.

Your kit does not come with a pinion gear, so you will need to determine the size (number of teeth) that you will need and pick it up from your local dealer so that you can install it now.

Mount the pinion onto the motor shaft, using the set screw supplied with the pinion, so that the end of the pinion gear is flush with the end of the motor shaft. Now install the #8110 motor spacer (in a separate bag in the master bag) onto the motor. See Fig. 53. **Note:** With some of the larger pinion gear sizes you will have to remove the pinion gear in order to install the motor spacer and then reinstall the pinion gear.

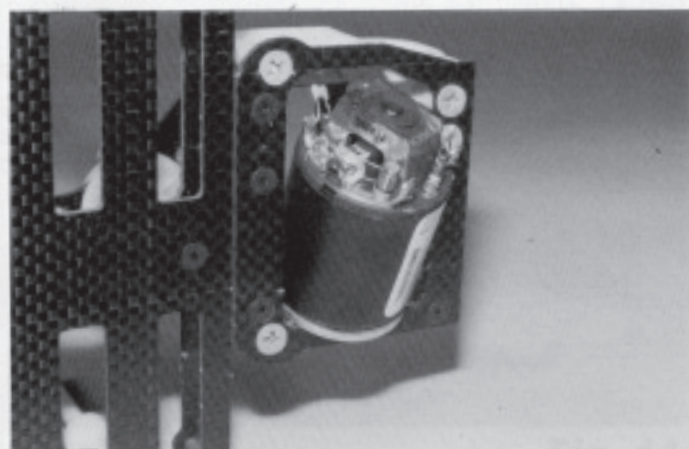


**Fig. 52**

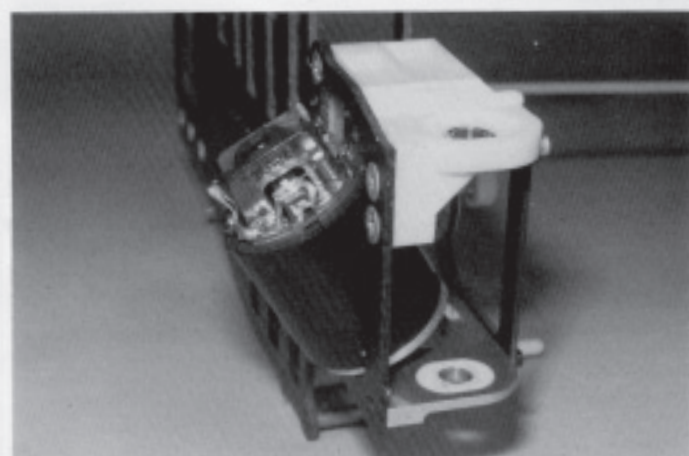


**Fig. 53**

❑ **Figs. 54 & 55** The motor is mounted into the chassis through the bottom of the rear pod, as shown.

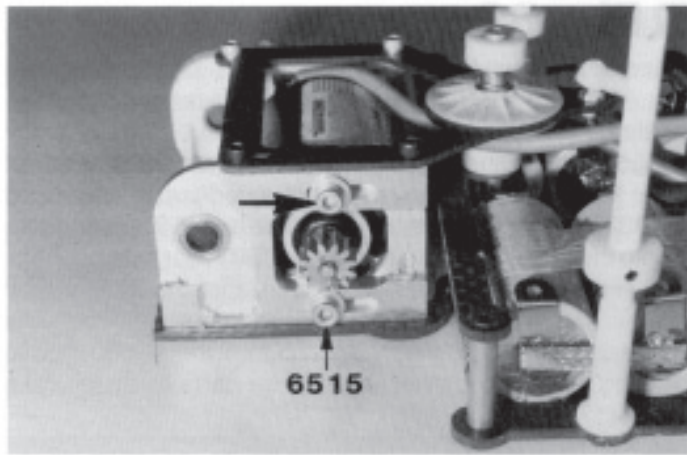


**Fig. 54**




**Fig. 55**

❑ **Fig. 56** In the master bag you will find a small bag with two gold-colored #6515 3mm x 10mm socket head cap motor mounting screws and two #6936 #4 aluminum flat washers. Place one of the #6936 #4 aluminum flat washers on each of the two #6515 motor mounting screws. Now slide the two screws with washers through the right hand motor bulkhead as shown in Fig. 56. Line up the screws with the mounting holes in the motor spacer and the motor and tighten the screws, but not all the way. We will have to adjust the motor later.

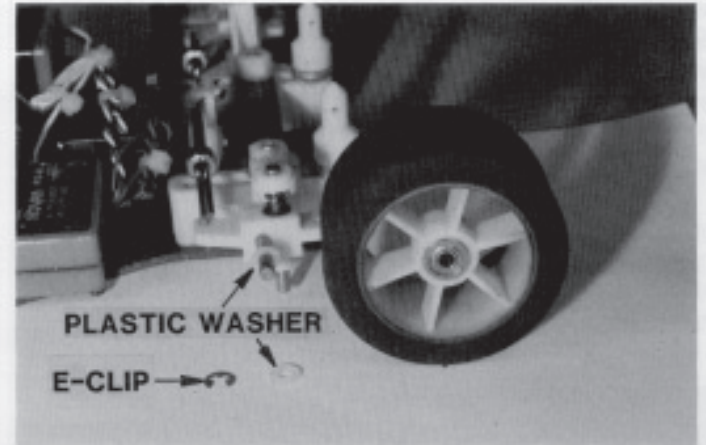


**Fig. 56**


 #6515  
3 mm x 10 mm  
metric (gold)

 #6936  
#4 flat washer  
aluminum

**Fig. 58 & 59** Back in bag #1 you will find two small #4187 nylon axle washers. Slide one onto the right front axle then install the wheel with bearings onto the same axle. Secure the wheel with a #6299 1/8" E-clip. Now go back and do the left front wheel assembly.



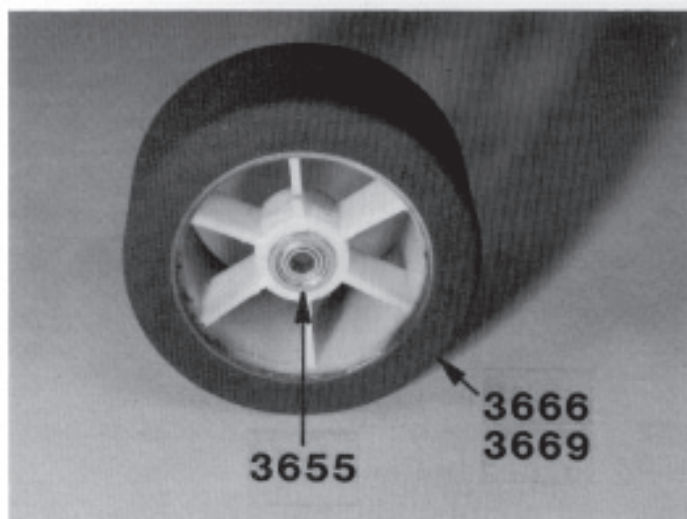
**Fig. 58**

 #4187  
washer


 #6299  
e-clip  
1/8 shaft

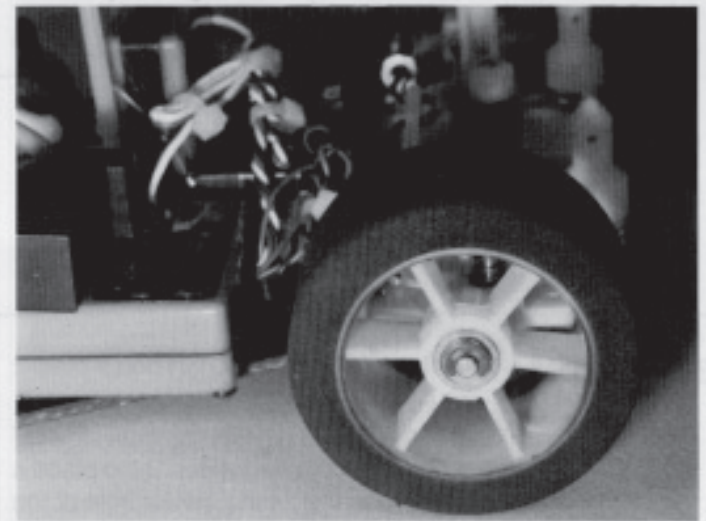
## FRONT WHEELS SECTION

**Fig. 57** In the kit box you will find a smaller box containing the front and rear wheels and tires. Take out the #3669 front wheels and tires. Back in Figs. 24 & 25 we opened up the bearing bag. We now want to take out the four smaller #3655 1/8" x 5/16" flanged front wheel bearings from this bag. Install a #3655 bearing into the inside and outside of the #3669 front wheels as shown.



**Fig. 57**

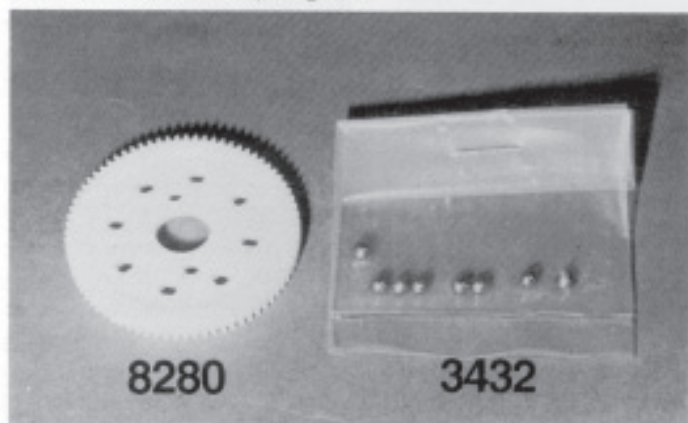
 #3655  
1/8 x 5/16  
flanged bearing



**Fig. 59**

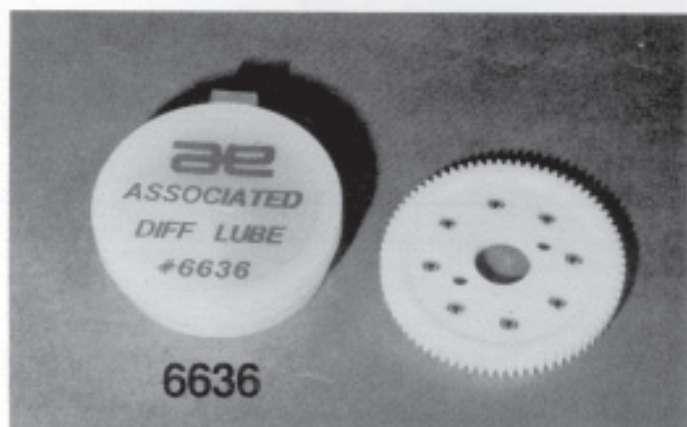
# DIFFERENTIAL SECTION

**Fig. 60** Take out bag #8 and remove the smaller bag containing the #3432 1/8" differential (diff) balls. In the same bag you will find the #8280 75 tooth 48 pitch spur gear. Install the eight #3432 1/8" diff balls into the ring of eight holes on the #8280 spur gear.



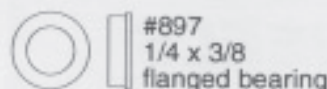
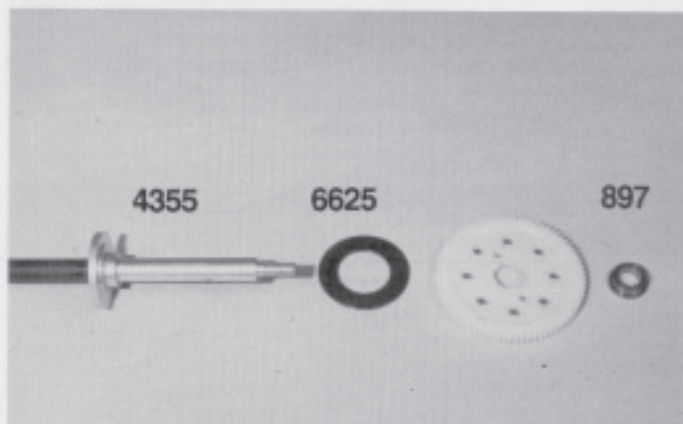
**Fig. 60**

**Fig. 61** In the master bag you will find a plastic container of Associated #6636 silicone differential lube. Place a small amount of the #6636 diff lube on both sides of each diff ball in the #8280 75 tooth spur gear. Also place a very small amount of diff lube inside the center hole of the #8280 spur gear. **Caution:** Associated has gone to a lot of time and effort to find the correct silicone lube compound to use on the differential gear. Please use the supplied lube on our car.



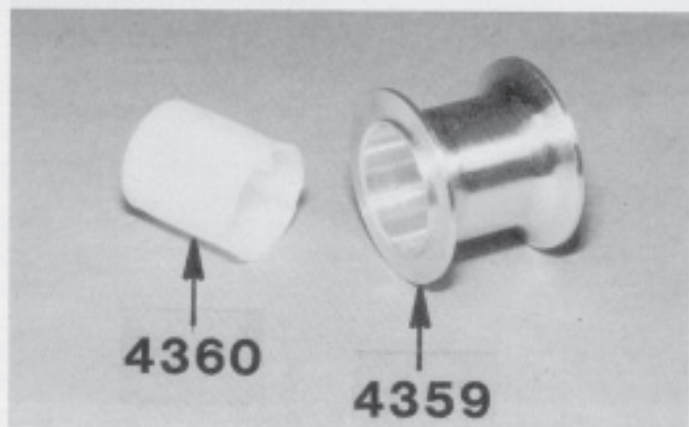
**Fig. 61**

**Fig. 62** In bag #8 you will find the #4355 graphite rear axle, and two #6625 diff drive rings. Take the remaining two #897 1/4" x 3/8" flanged rear axle bearings out of the bearing bag. Slide one of the #6625 drive rings onto the #4355 rear axle and seat it onto the aluminum hub. It is easier to do if you hold the axle upright (hub side up). Now install the #8280 spur gear with balls onto the axle diff hub and seat it onto the hub. Now take one of the #897 rear axle bearings and slide it onto the axle. Make sure that the flanged end goes on first and that it seats down against the diff hub. This ball bearing must be able to slip into the #4360 plastic bearing mount later. We will set these parts aside for just a moment.



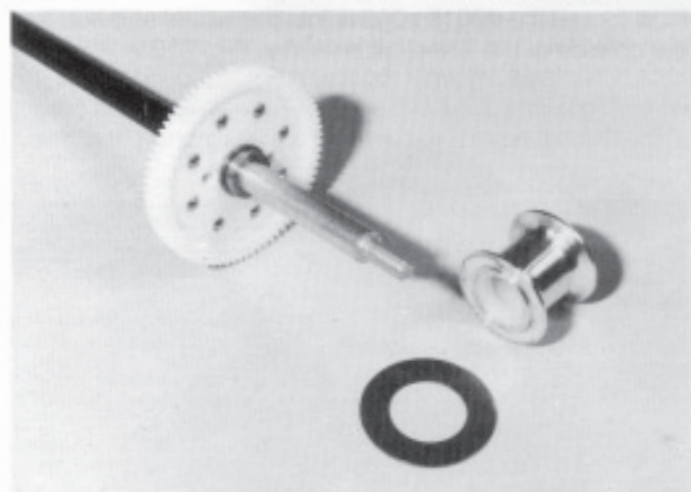
**Fig. 62**

**Fig. 63** From bag #8 remove the #4359 right rear wheel diff spacer and the #4360 plastic bearing mount. Remove any flashing from the outside of the #4360 plastic bearing mount on the thin side and from the inside of the rounded or thick side. Be certain only to remove flashing from the inside so that the bearing will still fit correctly when installed. Press the #4360 plastic bearing mount into the #4359 right hand wheel/diff spacer so that the thin end of the bearing mount goes in first.



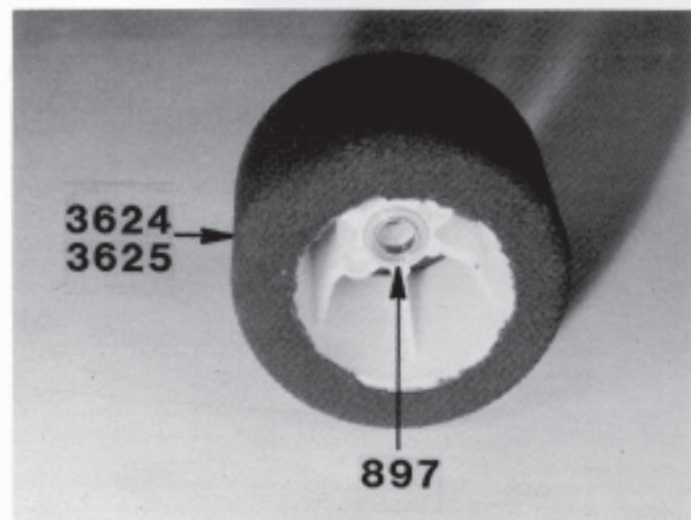
**Fig. 63**

□ **Fig. 64** Now pick up the rear axle assembly as before and place the second #6625 drive ring over the hub onto the axle. Now slip the #4359 right hand wheel/diff spacer onto the axle (bearing adapter side first) making sure that you center the drive ring so that the wheel/diff spacer will seat correctly. Remember the wheel/diff spacer has to seat on the bearing as well as the drive ring.



**Fig. 64**

□ **Fig. 65** Take one of the #3625 rear wheels with tires and push the last #897 1/4" x 3/8" flanged bearing (from Fig. 62) into the outside of the wheel center as shown. This wheel will become our right hand diff wheel.

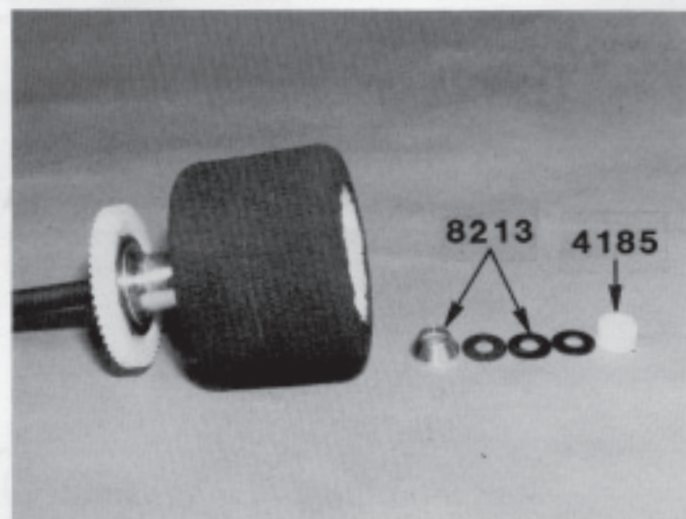


**Fig. 65**

○ #897  
1/4 x 3/8  
flanged bearing

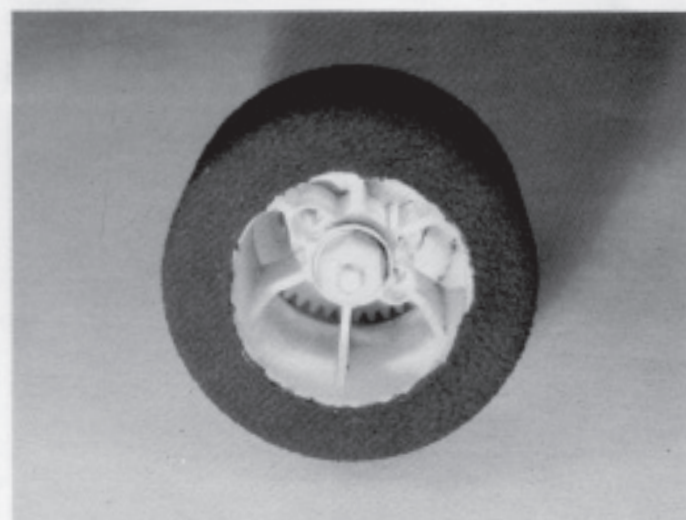
□ **Figs. 66 & 67** You can now slide the #3625 wheel with bearing over the axle making sure that the bearing goes onto the smooth part of the axle just past the threads. In bag #8 you will find the #8213 diff thrust cone parts and the #4185 8-32 nylon locknut. The diff thrust cone assembly consists of a tapered aluminum cone and three belleville (cone shaped) washers. Install the #8213 diff thrust cone so that the small tapered end goes on first. Now install the three belleville washers, making sure that the raised center is facing out on each one. All three washers will fit inside the lip of the diff thrust cone. Now thread on the #4185 8-32 nylon locknut and tighten it by hand.

Try holding the axle with your left hand and then turning the wheel with your right. It should roll smoothly back and forth. If it doesn't, the drive rings are misaligned, so loosen the nylon locknut and correct the problem. We will finish adjusting the diff later in the instructions.



**Fig. 66**

○ #8213  
Belleville washer      ○ #8213  
thrust cone



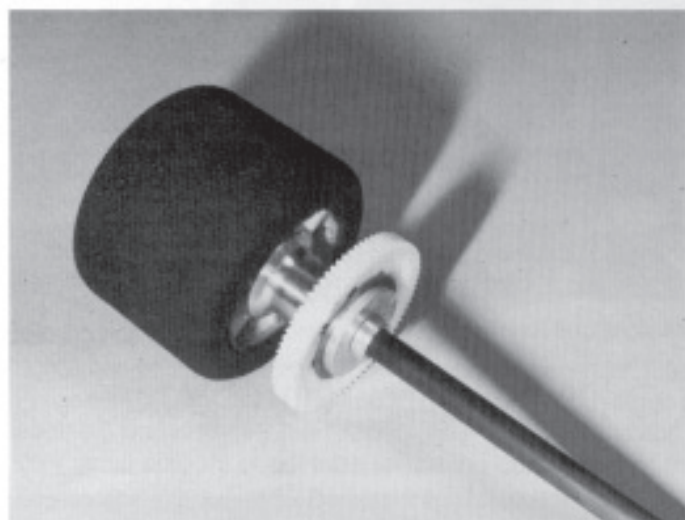
**Fig. 67**

○ #4185  
8-32 locknut  
aluminum

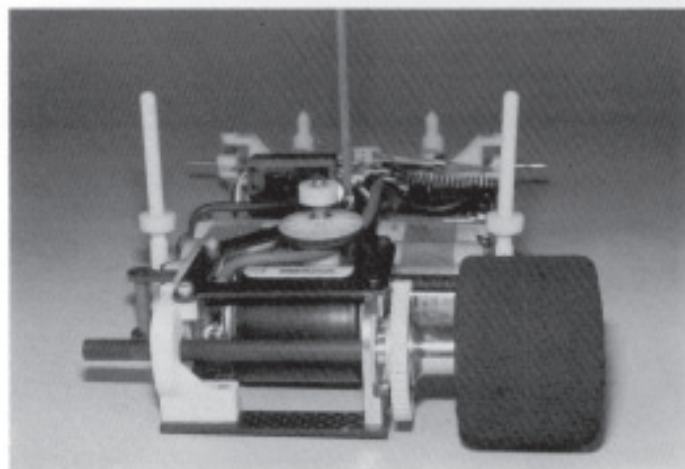
□ **Figs. 68A, 68B & 69** In bag #8 are two small #8321 aluminum rear axle spacers (fig. 68A). The spacers have a stepped surface on one side which is designed to ride against the inner face of the #897 bearings. Install one of the #8321 spacers over the graphite portion of the rear axle with the stepped side away from the wheel. We are now going to slide the rear axle assembly into the rear pod from the right hand or passenger side. Slide the axle all the way in until the #8321 axle spacer makes contact with the #897 bearing that is in the motor bulkhead. Check to make sure that the pinion gear is not interfering with the spur gear which will prevent the axle from going all the way in.



**Fig. 68A**



**Fig. 68B**



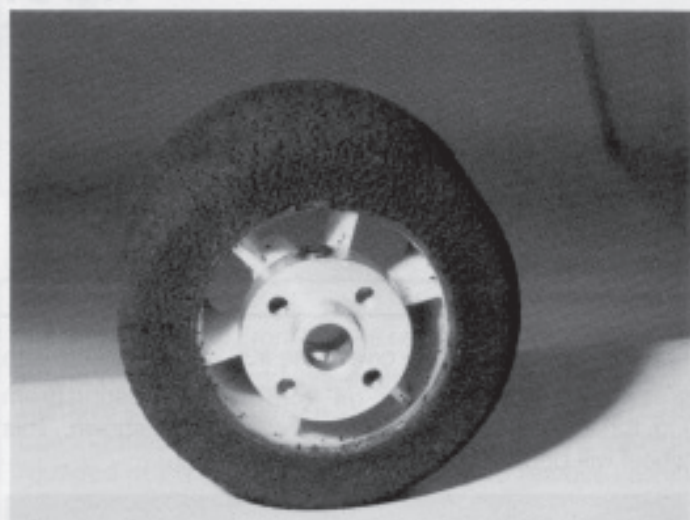
**Fig. 69**

□ **Figs. 70, 71A & 71B** Take the #3613 left wheel hub and #3616 10-32 x 5/16" set screw and two #3615.5-40 x 5/8" SHCScrews from bag #8. Install the #3616 set screw into the #3613 left wheel hub and then mount the hub to the back side of the remaining #3625 wheel and tire (see Fig. 71A). Line up two of the mounting holes in the wheel hub with the mounting holes in the left wheel. Now thread the #3615 screws into the wheel and hub from the outside of the wheel as shown in Fig. 71B.

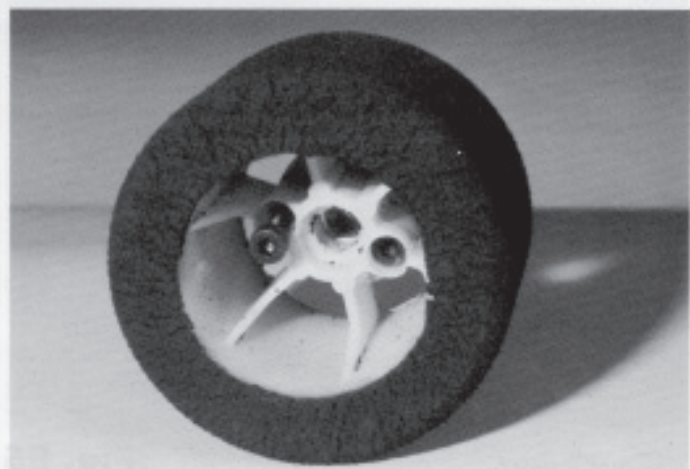


□ #3615 5-40 x 5/8      #3616 set screw

**Fig. 70**



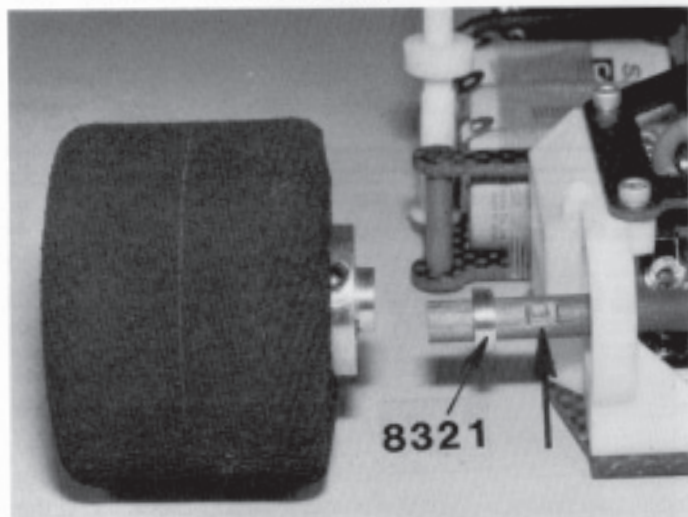
**Fig. 71A**




**Fig. 71B**

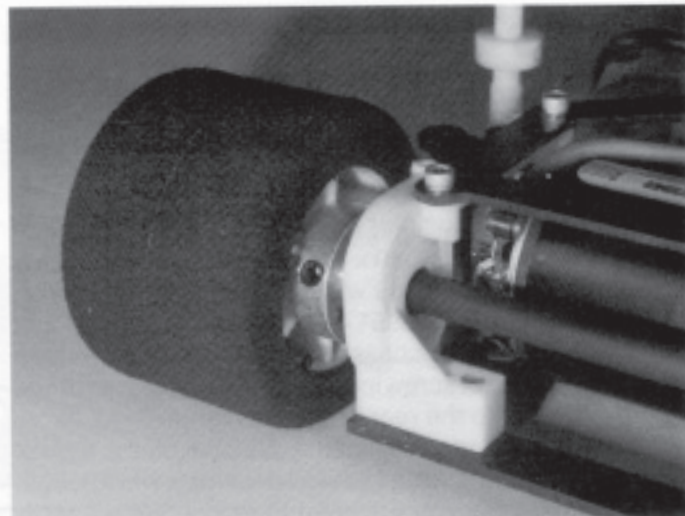
**Fig. 72** Take the second #8321 rear axle spacer from bag #8 and slide it onto the left (drivers) side of the rear axle. Make sure that the stepped side faces towards the bearing in the left hand plastic bulkhead. Slide the left hand wheel and tire assembly onto the rear axle until it touches the #8321 rear axle spacer. Tighten the left wheel hub set screw just enough so that it will leave a small mark on the graphite axle.

Now remove the wheel and spacer and slide the rear axle assembly out of the rear pod. Now file a small flat spot into the graphite rear axle where the set screw touches as shown in the photo. This is to help make removal of the axle much easier for future servicing.



**Fig. 72**

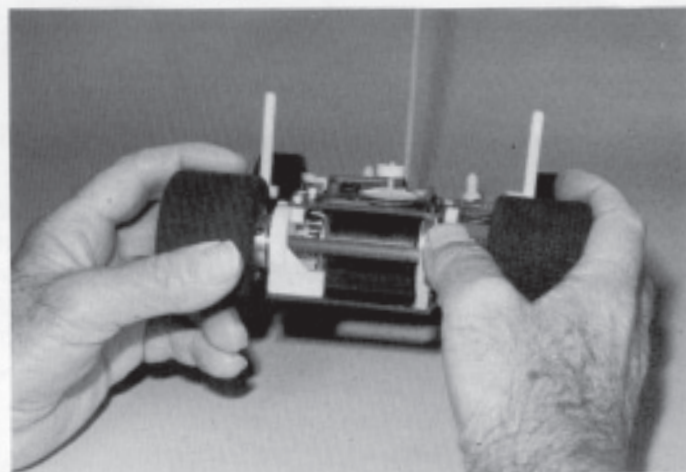
 #8321 axle spacer



**Fig. 73**

Now it's time to make the final diff adjustments. Hold the left hand wheel in your left hand and the right hand wheel in your right hand, as shown. Hold the wheels to keep them from turning. Now take your right thumb, as shown, and push on the spur gear to see if you can turn it. If it will not turn, loosen the adjustment nut (shown in Fig. 67) until you can just barely push the gear forward. Now tighten the nut a tiny bit and see if you can still move the spur gear. When you cannot move the spur gear then the diff is adjusted correctly.

**Fig. 74** Now it's time to make the final diff adjustments. Hold the left hand wheel in your left hand and the right hand wheel in your right hand, as shown. Hold the wheels to keep them from turning. Now take your right thumb, as shown, and push on the spur gear to see if you can turn it. If it will not turn, loosen the adjustment nut (shown in Fig. 67) until you can just barely push the gear forward. Now tighten the nut a tiny bit and see if you can still move the spur gear. When you cannot move the spur gear then the diff is adjusted correctly.



**Fig. 74**

**Fig. 73** Now reinstall the rear axle assembly, then the left hand axle spacer and finally the left wheel and hub assembly, making sure that the set screw is lined up with the flat spot we filed into the rear axle. Tighten the set screw lightly. We now need to check end play on the axle. See if the axle will slide a very small amount to the left and right. If it does then go ahead and tighten the set screw down. If not loosen the hub set screw and move the wheel and hub a little to the left. This is to prevent any binding on the rear axle bearings which would slow down the cars performance.

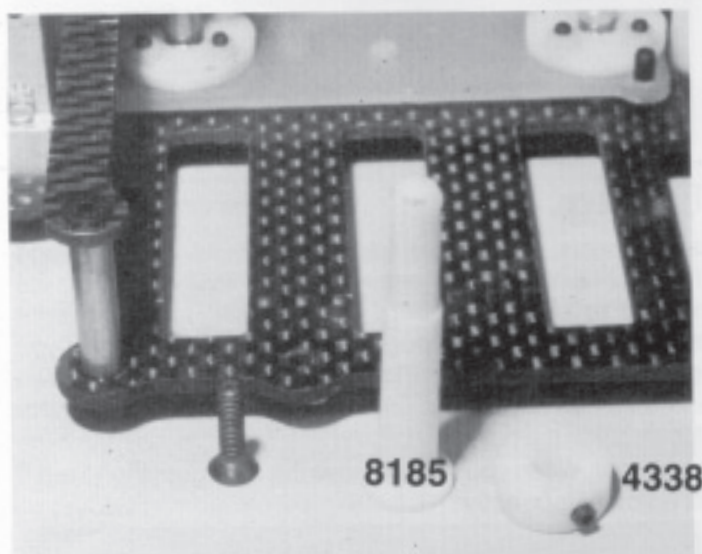
**Racers Tip:** Many of the Team drivers place a piece of paper between the wheel hub and spacer to make setting the end play easier and faster.

# BODY MOUNT SECTION

## □ Figs. 75A, 75B & 75C

In bag #2 you will find two #8185 3" rear nylon body mounts and two #6922 4-40 x 1/2" FHSScrews. In the same bag with these mounts you will also find two #4338 nylon locking collars and two #6951 4-40 x 1/8" set screws. Mount the body mounts to the chassis as shown in Fig. 75A. Now thread one #6951 set screw into each locking collar and then slip the collars onto the rear body mounts.

Now you will need to make a decision on the type of body you are going to run as this will determine which length of front body mount you will need to mount. We will show installation of the #3320 front body mount. Take the two #3320 body mounts and two #3324 8-32 Aluminum FHMScrews from bag #2. Install the #3320 nylon body post to the front of the chassis holes as shown in Fig. 75B. Make sure that the body pin hole face across the chassis as this will make installation of the body pins easier later on. *Racers Tip: The Team drivers will mount the body and then cut the rear body mounts down and re-drill them for the body pins so they just clear the body, reducing drag on the car.*



8185

4338

#6922  
4-40 x 1/2

#3324  
8-32 x 1/2  
aluminum

Fig. 75A



3320

Fig. 75B

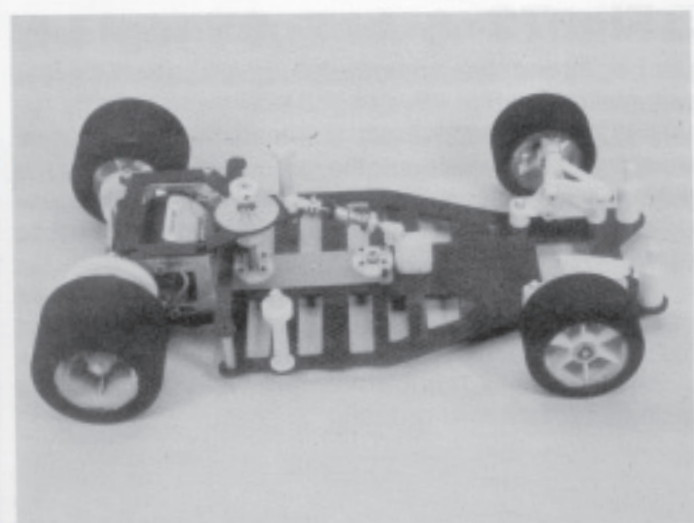


Fig. 75C

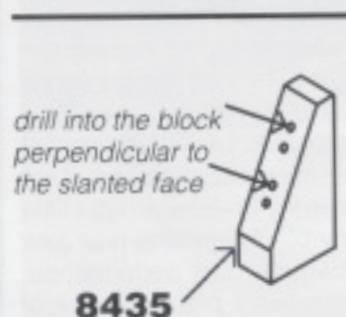
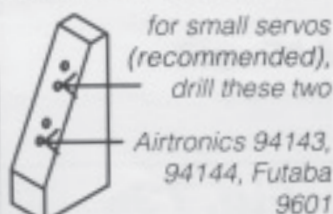
# ELECTRICAL SECTION

## □ Figs. 76 & 77

Now its time to start installing the radio gear and electronic speed control. We will start with the steering servo. Go back to bag #1 and remove the two #8435 servo mounting blocks. We are going to drill two holes into each servo mounting block using the #43 drill bit (3/32" will work if you are very careful).

The drawings in Fig. 75 show which holes to drill depending upon which servo you are going to use. After you have determined which mounting holes to use drill out your holes making sure that you drill the hole perpendicular to the slanted face of the servo mounting block. Do both blocks.

**Note:** Recommended servos are Airtronics/Sanwa 94143, 94144, 94831 or Futaba S132SH, S32SH, 9601. Other brands or small or mini servos will work but the correct adjustments for these servos would be your responsibility.



(NOT ACTUAL SIZE.)

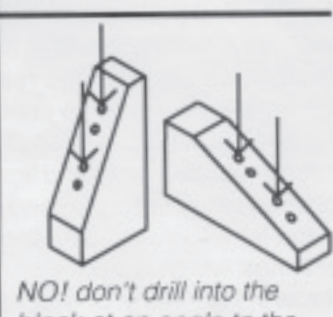
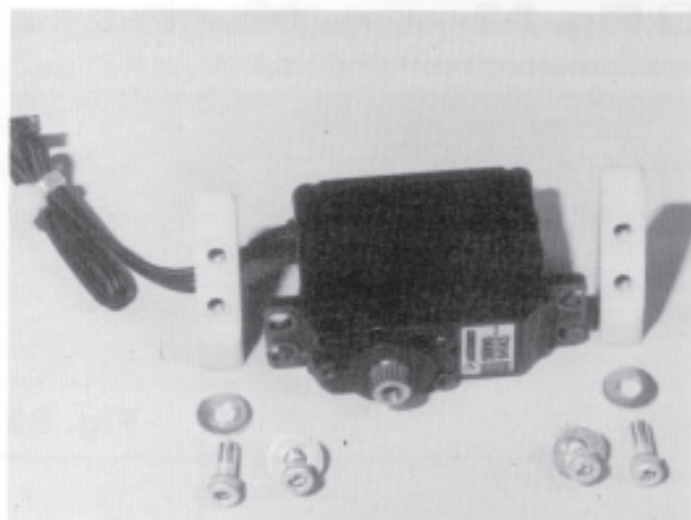


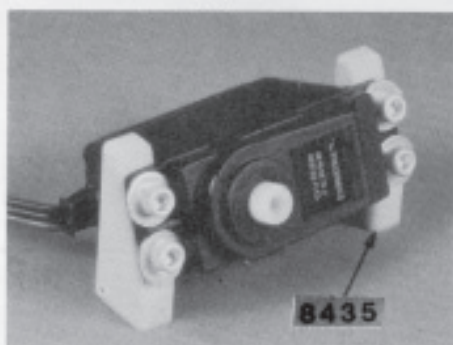
Fig. 76





**Fig. 77**

**Fig. 78** Take the four #4145 4-40 x 5/16" Aluminum SHCScrews and four #6936 #4 Aluminum flat washers from bag #1. Place a washer on each screw and mount the servo to the servo mounting blocks as shown.

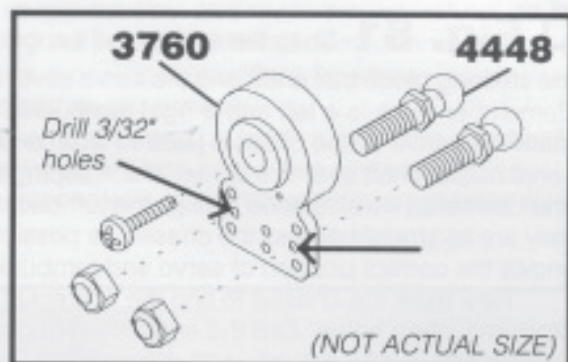


**Fig. 78**

#4145  
4-40 x 5/16  
aluminum

#6936  
#4 flat washer  
aluminum

**Fig. 79** In bag #1 you will find the #3760 Airtronics servo saver (we also have available servo savers for Futaba and Novak servos in your catalog). On each side of the servo saver you will see three holes (as shown); take a 3/32" drill bit and carefully drill out the middle hole on each side. Take two #4448 Aluminum ball ends and two #4449 4-40 small locknuts from bag #1. Screw the #4448 Aluminum ball ends into the back side of the #3760 servo saver. Secure the ball ends with the two #4449 small locknuts on the front side. Install the servo saver onto the servo (with balls on the bottom side) but only lightly tighten the mounting screw. We will tighten it after we have installed the radio and centered the steering servo.



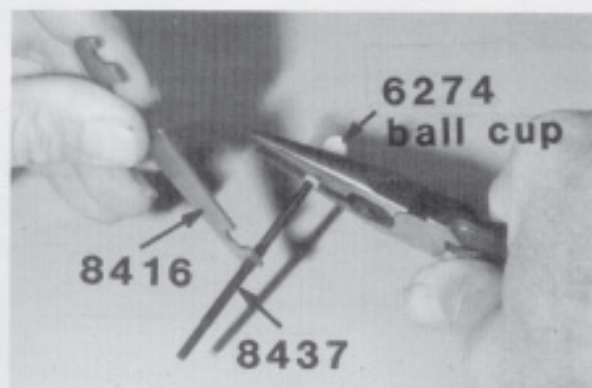
**Fig. 79**



use for #4448

#4449  
4-40 locknut

**Fig. 80** The two #4404 steering turnbuckles and four #6274 plastic ball cups are in bag #1. Screw two of the #6274 plastic ball cups onto each of the steering turnbuckles. Tighten the ball cups until you get a center to center (center of ball to center of ball) length of 2.187" (55.55mm). The drawings at the bottom of the photo are at 1:1 scale so you can match them to the drawing for direct measurement of turnbuckle length. Notice the difference between the direction of the ball cups on both left and right turnbuckles.



6274  
ball cup

8416

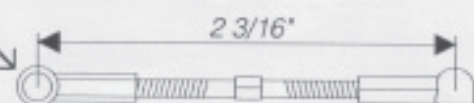
8437

#4404

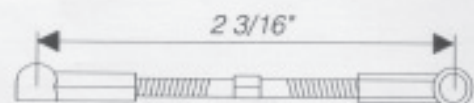
**Fig. 80**

hold ball cups  
still with pliers  
while turning  
turnbuckle with  
tool.

use for  
#4404



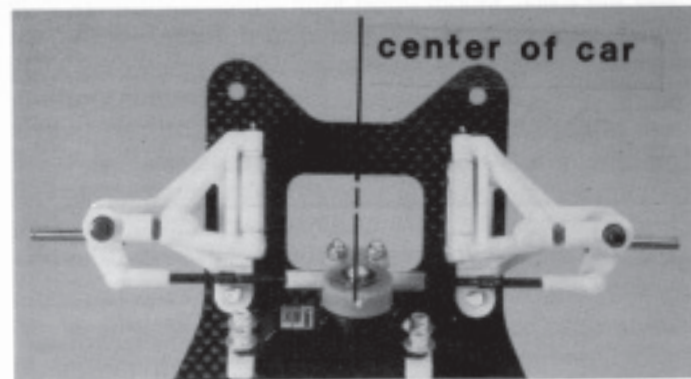
left side turnbuckle



right side turnbuckle

**Fig. 81** Snap the assembled turnbuckles onto the steering block ball ends and the servo saver ball ends. Remember there is a left and a right turnbuckle. Carefully mark the center of the chassis (side to side) and align the servo output shaft over this center line. Keeping the output shaft centered we also need to align the turnbuckles so that they are as straight across the chassis as possible. Fig. 80 shows the correct position of servo and turnbuckles.

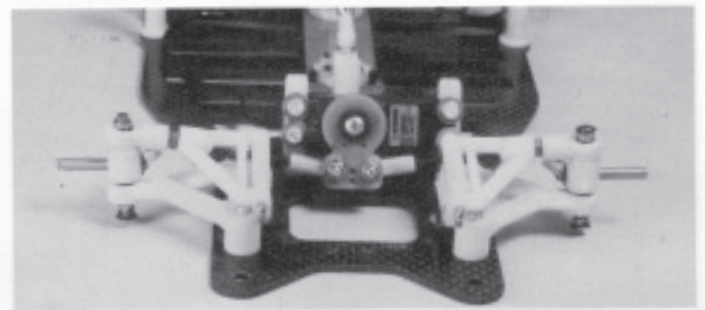
Now mark the chassis to find the centers of the servo block mounting holes. Drill the servo block mounting hole centers with a #34 drill bit (1/8" will work). If you want to countersink the chassis, use the enclosed #6292 4-40 x 3/8" FHSScrews. You will need to use a 82 degree countersink. If you do not have access to a countersinking tool we have also included two #6919 4/40 x 3/8" BHSScrews that can be used.



 #6919 4-40 x 5/16  #6292 4-40 x 3/8


**Fig. 81**

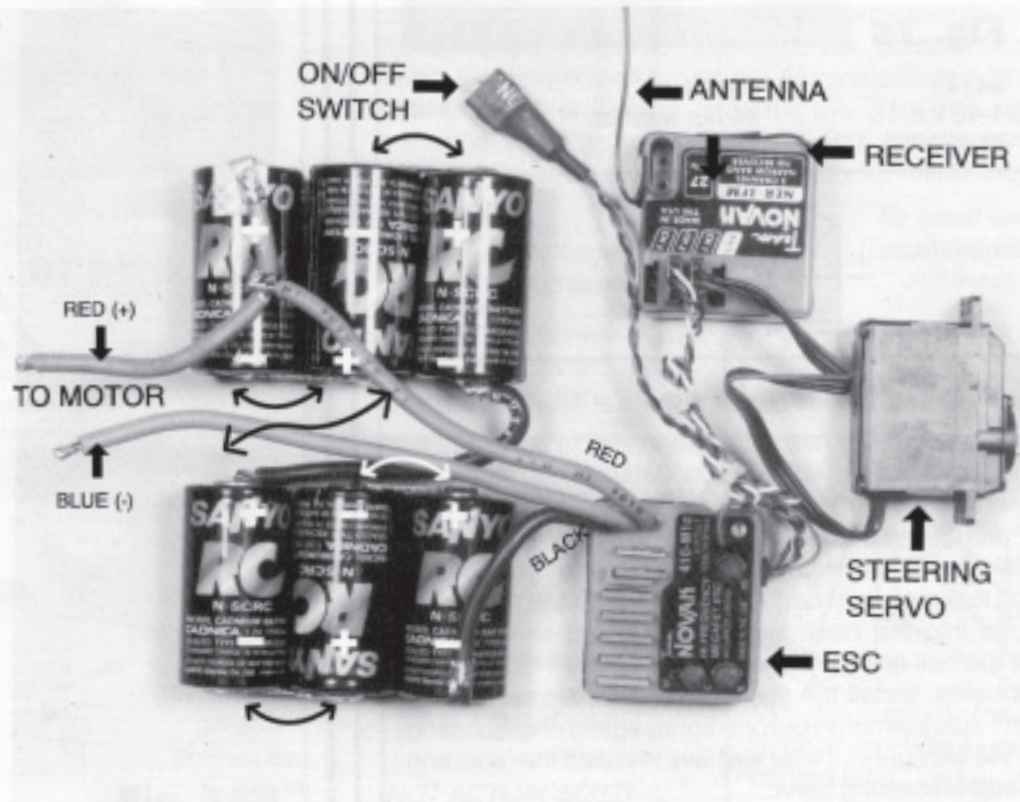
**Fig. 82** Your completed servo and servo mount installation should look like Figs. 80 & 81.



**Fig. 82**

**Fig. 83** Fig. 84 shows the basic layout of the different parts of the rest of the electrical system. The photos show both a Novak High Frequency Speed Control and a three channel FM Receiver along with Sanyo 1700 mah SCRC Batteries.

 = solder battery ends here with battery strap braid in series (positive to negative).



**Fig. 83**

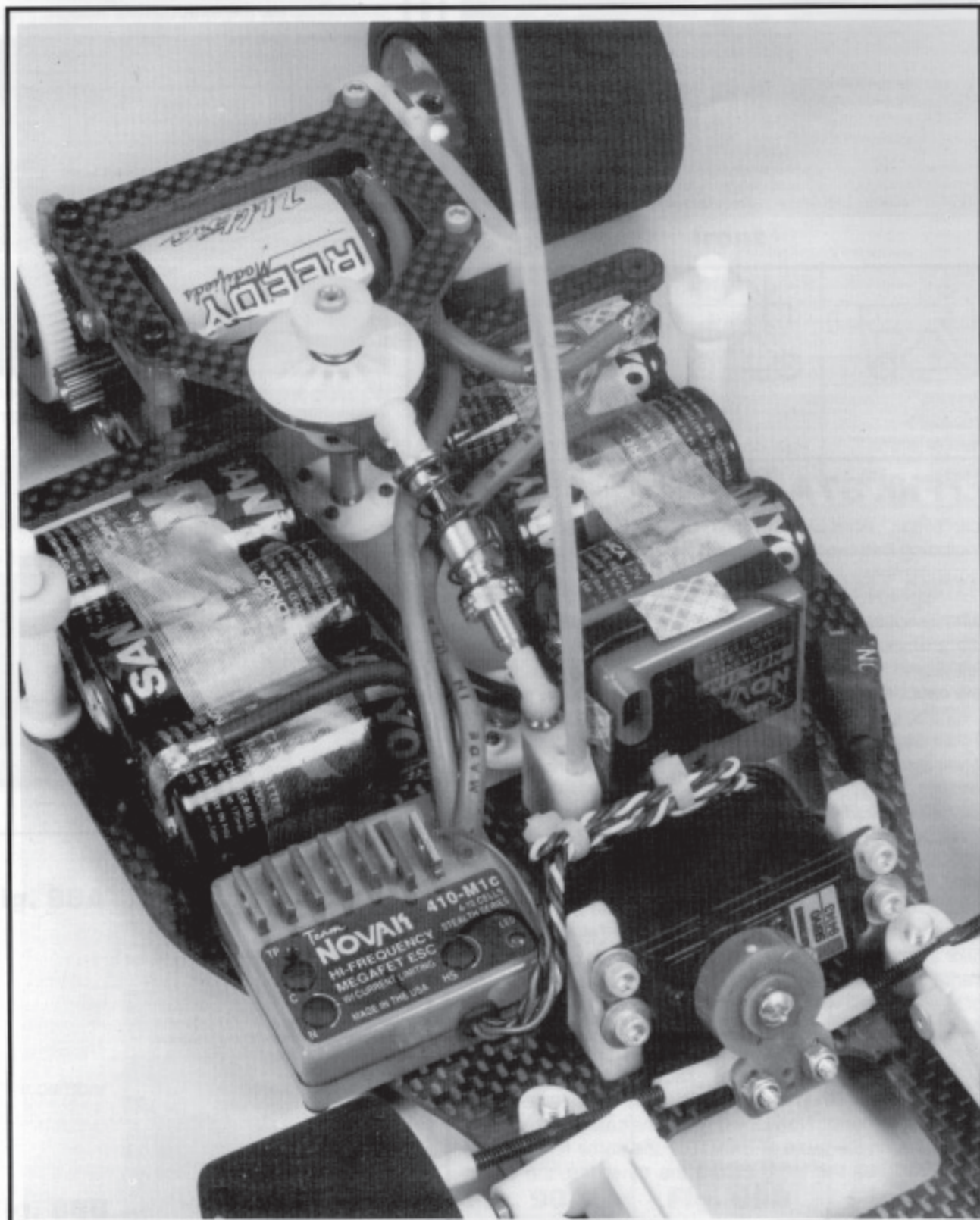
□ **Fig. 84** After all your connections have been made according to Fig. 83, mount the set-up in the car as shown here.

This figure shows the same components installed in the car, which should give you an idea of how tight a fit it can be mounting everything in a 1:12 scale car!

**NOTICE:** Because of all the different designs and

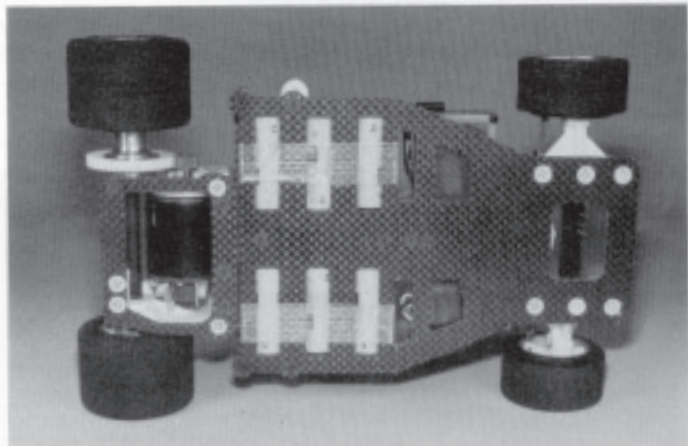
sizes of speed controls and receivers we will not go into detail laying out all of the different components. Always go by the manufacturers' instructions for proper installation of receivers and speed controls.

The important things to follow are to keep your battery and motor wires as short as you can and to do your best to keep the antenna wire away from any battery or servo wires.



**Fig. 84**

□ **Fig. 86** This photo shows how the batteries are held in with reinforced strapping or filament tape. The tape is run around the battery cells and the chassis as shown.



**Fig. 86**

□ **Fig. 87A & 87B** Now its time to set the car "tweak". After EVERYTHING ELSE is installed on the car, including batteries, motor, speed control, and all the radio equipment, we can set the "tweak".

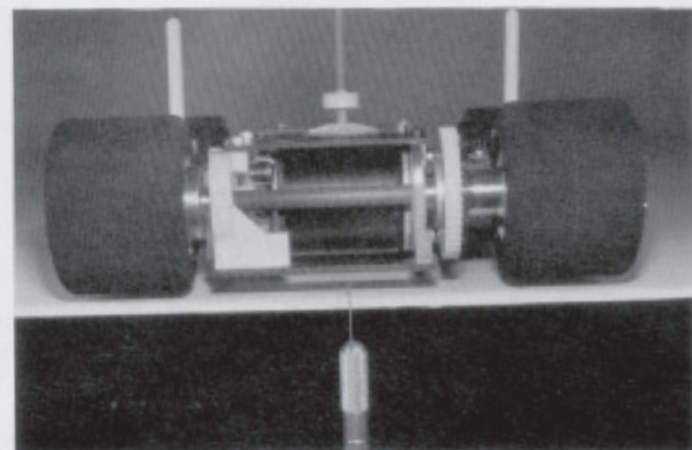
**SETTING THE TWEAK.** What is tweak? The left front wheel should be pushing down on the ground with the exact same amount of weight as the right front wheel. Likewise the left rear wheel should be pushing down on the ground with the exact same amount of weight as the right rear wheel.

If this isn't happening, the car is TWEAKED (or twisted). This will cause the car to spin out easily under acceleration; it will also cause it to have oversteer in one direction and understeer in the other direction.

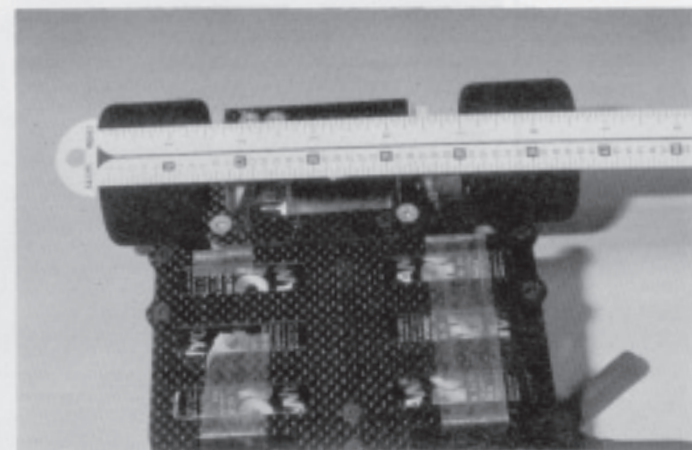
**TO CHECK THE TWEAK,** take a ruler and measure from the outside of the left hand rear tire to the outside of the right hand rear tire. Now take exactly half of that amount and mark the EXACT centerline of the car on the #4427 lower rear brace. You can just scratch a mark on the bottom of the brace with an X-acto® knife. **Racers Tip:** Team drivers will take a small drill bit and make a countersunk mark on the center point of the rear end so they have a place for the tip of their X-acto® which makes it easier to find the same spot each time. Now place the car on a flat level table.

Take the hobby knife blade and put the edge of the blade underneath the bracket exactly where your mark is and very slowly lift up on the blade until the rear wheels are just off the ground. Now slowly lower the car. Both rear tires should touch the table at EXACTLY the same time. If one wheel touches the table before the other tire, the car is tweaked.

**TO CORRECT THE TWEAK,** refer back to Fig. 16 where we installed the tweak set screws (arrows point to tweak set screws). Now loosen the tweak set screw, on the tire side that touched last, 1/8 turn and tighten the tweak set screw, on the tire side that touched first, 1/8 turn. Recheck the tweak. Continue to make adjustments until both rear tires touch at EXACTLY the same time. When they do then you have adjusted the tweak correctly. **IMPORTANT:** Always loosen one of the two screws first and then tighten the second screw the exact same amount.



**Fig. 87A**



**Fig. 87B**

# TUNING AND RACING TIPS

## YOUR FRONT END

The new front end on your RC12LS gives you the ability to make adjustments much easier and quicker which means you can try different settings more frequently. Many of the adjustments in this section are general and will apply to all radio controlled cars, while some are unique to only a few. Try to be methodical when making your adjustments and keep notes. Remember, it is normal to have a slightly different set-up for each track you drive on.

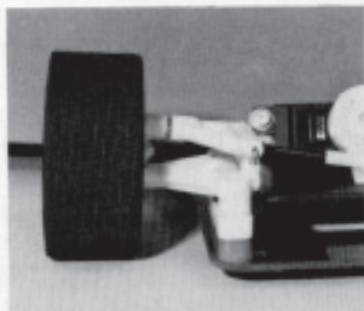
An important point to keep in mind when making adjustments to your car: you rarely get something for nothing. What you gain on one characteristic you will normally sacrifice on another characteristic to some extent. The trick is learning to balance the gains in relation to the losses.

**Fig. 88A & 88B CAMBER** is a word describing the angle at which the tire and wheel rides relative to the ground (see Figs. 88A & 88B).

Negative camber (Fig. 88A) means that the tire leans inward at the top, putting it closer to the centerline of the car than the bottom of the tire. Positive camber (Fig. 88B) means just the opposite, the top of the tire further away from the centerline of the car than the bottom of the tire. We suggest a starting setting of zero or one degree of negative camber. This can be adjusted by turning the upper arm turnbuckle in the appropriate direction.

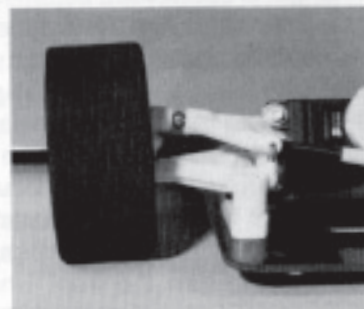
After driving the car, check and see if your front tires are wearing flat. If not, adjust the camber for flat tire wear. This will give you the maximum amount of steering. If slightly less steering is desired, add one or two degrees more of negative camber.

negative camber



**Fig. 88A**

positive camber

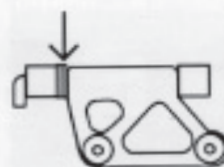


**Fig. 88B**

## Fig. 89A, 89B & 89C CASTER

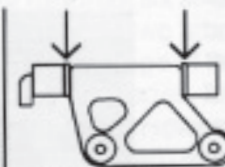
describes the angle at which the kingpin rides in relation to the vertical plane (looking at the car from the side). Negative caster means the kingpin leans rearward at the top. Caster has several effects; however, the easiest way to see its effects is to compare it to the casters on the bottom of a shopping cart. When the cart is pushed forward, any misalignment of the casters will cause a side load on the wheels and thus cause the wheels to align in the direction of travel. Increasing the negative caster on your car will increase the steering going into a corner and decrease the steering coming out of the same corner. Removing all negative caster (zero degrees) will remove a small amount of steering entering a corner but will give you maximum steering in the middle of and exiting the same corner. On your new front end, caster is adjustable in increments of two degrees by moving the small teflon shims as shown in the following three diagrams:

← front



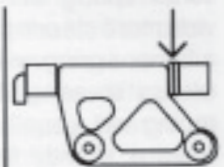
0° mount,  
0° caster  
2 shims forward

**Fig. 89A**



0° mount,  
2° caster  
1 shim each side

**Fig. 89B**



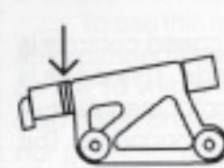
0° mount,  
4° caster  
2 shims to rear

**Fig. 89C**

## Fig. 90A, 90B & 90C CASTER

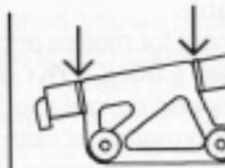
**CHANGE** is relatively new to the R/C industry and is also an important adjustment possible with the new front suspension. There are two types of upper arm mounts. One has no angle change, when mounted (Fig. 89A) in relation to the lower suspension arm, and the other has a ten degree angle, when mounted (fig. 90A) in relation to the lower suspension arm. This angle provides caster change during suspension movement. The caster will change two degrees during full suspension travel. Your car will steer more aggressively when using this option. Static caster is changed in the same manner as the zero angle arm mount (see Figs. 90A, 90B, & 90C). We suggest using this option only for road course applications (not oval), and only if an aggressive steering feel is desired.

← front



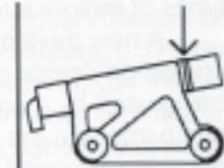
10° mount,  
0°-2° caster  
2 shims forward

**Fig. 90A**



10° mount,  
2°-4° caster  
1 shim each side

**Fig. 90B**



10° mount,  
4°-6° caster  
2 shims to rear

**Fig. 90C**

## □ Fig. 91A & 91B TOE IN AND TOE OUT

is a very helpful adjustment and has a significant effect on your car. Toe in will help stabilize your car and it removes a small amount of steering. Toe out will allow the car to turn quicker into a corner but will reduce stability exiting corner or on bumpy tracks. Both Toe in and toe out will scrub speed so try to use as little as possible. You can adjust by turning the steering turnbuckles.

**FRONT SUSPENSION SPRINGS** are available in six different wire sizes. They are:

part number	wire size
#4116	(.024)
#4117	(.022 in kit)
#4113	(.020)
#4114	(.018)
#4119	(.016)
#4118	(.014)



toe in

**Fig. 91A**

In general, a softer spring will provide more steering and a firmer spring will decrease steering. Oval racing will usually require a slightly firmer spring than road course racing.



toe out

**Fig. 91B**

## REAR DAMPENER ADJUSTMENTS

The rear dampener is a very important part of the car's overall handling. You want to keep the spring tension on the rear dampener washers as light as possible which will help keep the back of the car moving freely. You also want equal pressure or spacing on both the upper and lower spring. Many of the Team drivers will shave down the lower locking collar or replace the collar with washers to be able to make this adjustment. The main rule to understand is that tightening the dampener springs will give you more steering by taking away rear traction, and loosening the dampener springs will take away steering by giving you more rear traction.

## YOUR MOTOR

Associated recommends the Reedy Modified line of R/C motors. Reedy motors have won ten IFMAR World Championships. No other motor manufacturers have come close to this record. Check your 1:12 scale catalogs for the various types of motors available.

A new development for motors and speed controls is an add-on device called a SCHOTTKY diode. This diode is being used by many speed control and motor manufacturers to improve the performance of both components. The diode is supposed to keep the braking MOSFETs cooler to improve your braking performance and reliability, help prevent integrated circuit lockup (which can occur with some of the new higher-performance motors used with high frequency speed controls), and improve the regeneration ability of the speed control. The diode, by reducing the high

voltage spikes that could reach your speed control, will reduce wear and tear on your speed control, which would then in turn reduce wear and tear on your motor. Reedy Modifieds sells these diodes (#745) which contains two diodes. **Caution:** The diodes are polarized, so make sure that you hook positive to positive and negative to negative. If connected backwards, the car will act like it has a shorted motor when the throttle is applied until the diodes short out.

If you take care of your motor correctly, it will not only last much longer but it will run faster over a longer span of time. Never deliberately stall your motor. If your car is stuck in the wall, do not punch the throttle; you could end up burning out your motor and speed control.

The following instructions came directly from a Reedy Modified Motor Maintenance instruction sheet:

Between runs, inspect the brushes to insure they are moving freely in the brush holder. This is done by carefully removing the spring and sliding the brush in and out of the holder. If there is any resistance or rough spots, remove the brush and carefully clean the brush with "Reedy-in-a-Can" Power Spray (Associated #750). This will clean off any build-up and lubricate the brush so it slides smoothly in the brush holder.

After every 3 to 5 runs, remove the brushes from the holders and inspect the tips for wear and/or burning. If there is a noticeable amount of wear, replace the brush with a new pair. To inspect for a burnt tip, look at the side of the brush on the contact end. If it appears a burnt blue color, then the lubricant in the brush has been burnt away and new brushes should be installed. These steps are important, for worn or burnt brushes can cause irreparable damage to the commutator.

After 2 or 3 runs you should carefully clean the motor. One recommended method is to connect the motor to an old battery pack and while it is running, spray a motor cleaner such as "Reedy-in-a-Can" Motor Cleaner (Associated #751) directly on the brush commutator area. Run the motor for approximately 15 seconds and apply the spray several times for 2 to 3 seconds. Disconnect the motor and spray again, making sure the run-off is clear and clean. If the run-off is still dirty, repeat the spraying action until clean. After completing the cleaning, apply a small amount of light-weight oil on the bushing or bearing for lubrication. Be careful not to apply too much oil, for this will pick up dirt and contaminate the commutator and brushes.

Never overgear your car (large pinion and/or spur gear). Overgearing can cause excess heat and can damage the motor.

## YOUR RADIO

Your car will work with any standard 2 channel surface radio system but you will find it easier to adjust the car and take advantage of its maximum performance if the radio has the following features.

First you want a radio with dual rate capabilities. Dual rate gives you the ability to reduce the amount of car wheel movement in relation to the amount for transmitter stick/wheel movement, making the car easier to drive. Remember you want to turn the front wheels the LEAST AMOUNT NECESSARY to get around the track fast, not the most

amount. The more you have to turn your front wheels sideways the more speed you are going to scrub off.

You also want the capabilities of adjusting the throttle trigger or stick for a seventy/thirty ratio. This means you can adjust the throttle so that 70 percent of the entire travel is used for forward throttle and thirty percent is used for braking.

## **BATTERY CHARGERS AND CHARGING**

Almost all of the current quick chargers on the market do the same thing—supply a charging current of about three to six amperes. They differ in the power source they use (either 12 volts D.C. or 115 volts A.C.) and in additional features. Your basic charger is normally an AC/DC timer charger. If you are racing some of the new features like constant current charging, pulse charging, or voltage peak detection may be beneficial. Naturally the more features the more expensive the charger becomes. For serious racing we recommend Novak or Tekin automatic battery chargers but there are other good manufacturers on the market now.

### **CHARACTERISTICS OF NI-CAD BATTERIES**

It is important to understand the characteristics of the battery pack in your car, because how you use it will greatly affect both its performance and its life. With proper care your pack will give you top performance for hundreds of cycles.

For 1:12 scale racing the R.O.A.R. (Radio Operated Auto Racing) or N.O.R.R.C.A. (National Organization for Racing Radio Control Automobiles) legal battery is composed of either four or six "sub-C" size cells with a maximum rated capacity of 1.7 amp/hrs. This means that the cell will supply 1.7 amperes one hour, or .85 amperes for two hours, etc. This capacity rating drops to about 1.5 amp/hrs at high drain rates. For instance, at twelve amperes (a typical average current drain for a 1:12 scale modified electric car) the cells would discharge in 1/7 of an hour (just over eight minutes). This charge capacity is the same regardless of the number of cells in the pack because the cells are connected in series and the same current passes through each one. In other words, the charge capacity of a four cell pack is the same as a six cell pack. The total energy storage of a six cell pack is higher, of course, because the voltage is higher.

Ni-Cads are very efficient and they give back almost as much as you put in, as long as you don't try to put in more charge than they will hold. If you start with a completely dead pack and charge at four amperes for 1/4 hour, you will have put a total of one amp/hr (4 x 1/4) into the cells. More than 95 percent of the charge would be recovered if the pack were then discharged at the one hour rate.

### **HOW TO TELL WHEN YOUR CELLS ARE CHARGED**

One of the problems with Ni-Cads is their inherent voltage stability; the voltage of a fully charged cell is not much different from one that's about dead. For that reason several indicators, along with some common sense, are needed in order to get the most out of your battery. The following is a list of indicators you should use to detect full charge.

**TEMPERATURE METHOD** This works only if you start with a cool battery pack. As the pack charges, frequently check its temperature by feeling the cells directly. As soon as you notice an increase in temperature, stop charging. If the cells become too hot to hold onto, your cells are overcharged. Let them cool.

**TIME CHARGE METHOD** This works only if you have confidence in the timing accuracy of your charger. Many chargers on the market only approximate a constant charging current; they may vary from six amps when you first start charging, all the way down to two amps if the Ni-Cad pack is nearly charged and the voltage of the charging source is low. If the charging current varies, it becomes difficult to estimate the average current. However, if your charger is reasonably dependable, you can use the following method.

Cycle your pack several times using the "temperature method" above. After you run the car the last time, let the pack cool. Charge again using the temperature method, but this time keep track of the time required to reach full charge. Once you have established the time, you can use it as a setting for the timer on your charger. To be safe use a setting about one minute less than what you established. This method allows you to charge without constantly monitoring the battery temperature.

If you charge a battery that is still hot from running, reduce the time about 20 percent. Then, after the pack has cooled, finish charging with the temperature method.

### **VOLTAGE METHOD**

As mentioned earlier, voltage is a poor indication of a cell's state of charge. The change in voltage from 10 percent charged to 100 percent charged is usually less than 0.1 volt per cell. In fact, other factors like temperature, current drain, and "cell memory" have a greater effect on voltage than the state of charge does. However, if current flow and temperature are held constant, it is possible to see the cell voltage gradually climb during the charging process. The absolute value of this voltage isn't of much use; how the voltage changes is an excellent indicator.

To use this method, you will need a digital voltmeter or an expanded scale voltmeter capable of resolving 0.01 volts on the 10 volt range. Connect the voltmeter across the Ni-Cad pack, preferably right at the cell terminals, or, if that is not possible, across the speed control battery lead pins. Don't try to read the voltage at the output of the charger because you'll end up reading the voltage drop through all the connectors and cables between the charger and the Ni-Cad pack, which can sometimes distort the effect you're looking for.

You should start with a Ni-Cad pack that is less than half charged. Connect your charger and begin charging at four amps. If your charger is adjustable, set the current now; do not try and change it later. A constant current charger is preferable here, but if yours gradually drops off during charge, that's still permissible, as long as it doesn't drop below three amps.

Watch the voltage as the pack charges. Notice that the voltage at first climbs rapidly and in the middle of the charging cycle more slowly. This voltage will most likely be in the range of 8.5 to 10 volts for a six cell pack. As the pack approaches full charge, the voltage will begin to climb more rapidly; and as it goes into overcharge, the climb will slow down and then stop. Stop charging at the point where the voltage stops climbing. If you left the charger on, the voltage would begin to fall as the pack went deeply into overcharge and started to heat up. The maximum voltage reached will probably be in the nine to ten volt region; the actual value is unimportant.

Do not try to use a conventional voltmeter. Even a good quality VOM with a large, taunt-band, mirrored-scale meter movement is not adequate; by the time you could see that the voltage has stopped rising, it would be too late.

**SLOW CHARGE METHOD** Slow or "overnight" charging is a method you are not likely to use very often. However, it is a good way to bring the pack to absolutely full charge. The charging current must be between 0.05 and 0.12 amperes. If less current, the pack will never reach full charge; any more and the pack will overheat. The time required to reach full charge ranges from 15 to 40 hours depending on the current used. The charger can be left on for a much longer time without harming the cells; however, the output voltage of the pack will be temporarily lowered by an extremely long overcharge. The voltage returns to normal after a discharge/charge cycle.

## **GETTING MAXIMUM VOLTAGE TO THE MOTOR**

The tips that follow are really for the benefit of the serious racers, since these tips deal with factors that influence the voltage and available power of a Ni-Cad pack. We're talking about a difference of maybe 15 percent at the most, so if you're just out having fun, don't worry about it. Instead, skip ahead to the body section.

The output of a fully charged pack can vary considerably, depending on the temperature and recent activity of the pack. These effects are listed below.

**HIGH TEMPERATURE** contributes its bad effects by lowering the output voltage under load. Less voltage means less speed. At normal 130 degrees Fahrenheit, the voltage of a six cell pack can be almost a volt less than normal. Since a lot of heat is produced in the pack while the car is running, it's important to allow air to circulate around the batteries to keep them cool. Therefore, before the start of a race, keep your car out of the sun and off the hot asphalt.

**MEMORY** can also affect the output voltage. The first memory effect is caused by overcharging. The cells "remember" that they were overcharged and put out less voltage near the end of the discharge cycle. This is particu-

larly noticeable if the pack is slow-charged for too long a time.

The second memory effect is caused by repeatedly not using up all of the battery's stored charge before recharging. The cells "remember" that they were not fully used and let the voltage drop off about one volt at the point where discharge usually stops. An example would be where you run a series of five minute heats, re-charging between each heat, and then try to run an eight minute heat. The battery voltage will be low for the last three minutes of the race. The cure is to fully discharge the pack before recharging. "Full discharge" means the point where the first cell goes dead. Never discharge beyond that point.

The third memory effect is the "topping-up" effect of recent charging. The cells remember that they were recently charged and will produce a little more voltage early in the discharge cycle. Racers take advantage of this by putting the last minute or two of charge into their pack just before the race starts.

## **YOUR BODY**

**MOUNT** your body on the car while it is still clear so you can see through it to easily mark and cut out the body mount holes and antenna hole. The bottom of the body should be even with the chassis.

**PAINT** your body by masking off the inside of the body with regular automotive masking tape according to the paint scheme. Follow the tips that come with your Lexan body which you must purchase separately. The best body paint to use is Pactra, available in almost all hobby stores.

## **YOUR WING**

You probably won't need a wing if you run on carpet, but if you run on asphalt, try the car with and without the wing to see which works best on your track.

*Good luck and we hope to see you at the race track!*



# Show Your Stuff!

All shirts printed front and back in blazing neon color on 100% cotton T's. Specify M, L, XL when ordering.

Send your orders to: **TEAM ASSOCIATED**  
3585 Cadillac Ave. Costa Mesa, CA 92626

# Decals!



↑ **Reedy Modifieds logo sheet.** 6" x 6".  
Hot Pink. #712, \$2.00.  
Blue. #713, \$2.00.  
Red. #714, \$2.00.  
Black. #715, 1.50.  
White. #716, \$1.50.



↑ **Realistic, full-color detailing for the RC10T truck.** 8 1/2" x 10". #7195, \$4.00



↑ **Associated name sheet.** Name fits on wing. Black only.  
1/12 scale. #3821, \$1.50.  
1/8 scale. #2811, \$2.50.



↑ **Over fifty 5-color emblems.**  
1/12 scale. #3820, \$3.00.  
1/8 scale. #SP-20, \$4.00.



↑ **Five colors. 1/10 scale off road.** 8 1/2" x 10". #6196, \$5.00.

↑ **Associated logo sheet.**  
1/12 black, 6 logos. #3818, \$1.00.  
1/12 white, 6 logos. #3819, \$1.00.  
1/8 black, 5 logos. #2812, \$2.50.  
1/8 white, 5 logos. #2813, \$2.50.

# T-shirts Caps!

same design front & back



same design front & back



↑ **World Championship T-shirt, 1991-1992.** Featuring the off-road champion, Associated's RC10! #SP-31, \$9.00.

↑ **Associated "Electric" T-shirt.** Features our popular electric car and truck line-up. #SP-32, \$9.00.

front



back



↑ **Associated "World Tour" T-shirt.** Includes Team's 10 World Championship cars on back. #SP-34, \$10.00.

front



back



↑ **Reedy Safari T-shirt.** Shirt is speckled light gray; design is black, neon purple and green. #SP-33, 10.00.

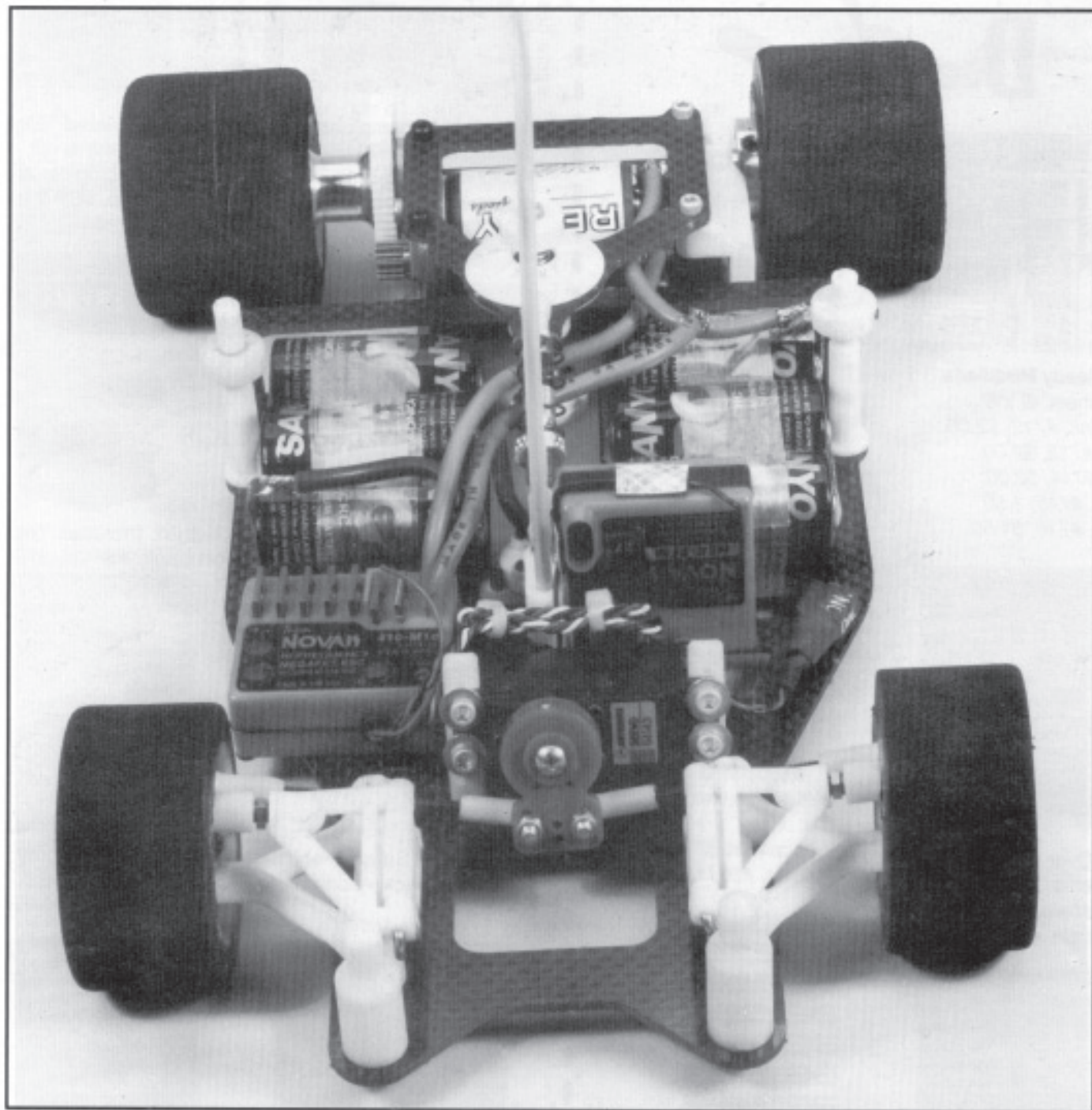


↑ **White and gray Reedy logo on hot pink.** 100% Polyester. One size adjusts to fit all. #701, \$8.00.



↑ **R/C car in full color printing on red, white and blue cap.** Vented back side. One size adjusts to fit all. #6970, \$7.00.

# RC12LS



ASSOCIATED ELECTRICS, INC  
3585 CADILLAC AVENUE  
COSTA MESA, CA 92626

**TEAM ASSOCIATED**