

ABOUT THE RC10T2

Congratulations on your new RC10T2 model truck kit purchase. We would like to tell you a little bit about your new truck and its history. Team Associated developed the first version of the RC10T in 1990. This was the first production truck to be designed from the ground up to be a truck. Before the RC10T, trucks were merely modified buggies with truck parts added. Since the original version, there were two additional models of the RC10T, the #7011 Sport Truck kit and the #7035 Team Truck kit, our race truck version.

With the RC10T2 we have moved trucks to the next level of performance. Associated has known for years about the advantages of an aluminum chassis. Starting from the ground up we developed a completely new one. This new computer-designed aircraft aluminum alloy hard anodized chassis provided us with improved front-to-rear rigidity, chassis side clearance, and reduced weight, but still providing you with a low center of gravity. The hard anodized finish improves its durability. We designed along with it our new integral rear end assembly. This consists of the rear bulkhead, shock strut, transmission case, motor plate and guard. When all of this is assembled you have one of the most rigid production main chassis structures available on any R/C truck today. This overall improved stiffness is one of the more obvious refinements.

Part of the improved rear structure includes the new 2.60:1 low profile Stealth transmission. It features a larger diff for increased torque capacity and reduced maintenance. It will also allow you to run even higher rpm modified motors without the normal gearing problems. This will give you the improved quickness and top speed you need to dominate your competition. But the design changes do not end here. The new transmission also has a new two piece motor plate and motor guard assembly. At the same time you will find a new lighter rear bulkhead and rear shock strut which interlock with the transmission case.

You will find our latest suspension and steering geometry changes give you a more aggressive yet easier handling truck with improved traction and rough track performance. The ease with which your new truck handles benefits both the new and experienced driver. You will find an improved battery mounting system designed for both six or seven cell battery packs. It can handle matched packs or stick packs and is designed to let you use either plugs or hard wire solder connections.

In the #7012 sport version you will find bronze bushings throughout, gold anodized shocks, three piece wheels with multi surface tires, dog bones and stub axles, mechanical speed control (with forward and brakes only) and a kit DS Spec motor. In the original #7036 ball bearing version you will find a new, Associated-designed, universal dogbone axle which is stronger and lighter and made to closer tolerances. To put the power to the ground this version also includes some of the same tires we race with. The Proline XTR compound "Edge" front tires and "Mini Pin" rear tires (with front and rear foam inserts) for improved steering and

traction. You still get our race proven hard anodized PTFE coated shocks and PTFE shock pistons, Associated Torque Control transmission clutch, and one piece racing wheels. To cover all of these new race enhancements both kits have a new racing truck body with a low center of gravity design.

How does this truck perform? The pre-production prototype TQ'ed both stock and modified classes and won the Stock National title at the 1994 ROAR Truck Nationals in Garden Grove, Calif. It then TQ'd and won the first NORRCA Electric Truck World Cup. It also TQ'd at the 1995 Winter Championships in Tampa, Florida.

All of the above changes mean your new RC10T2 truck kit is the finest race truck available. After you have driven your truck you will find out why Associated has won more World Championship and National titles than any other manufacturer. If you refer back to pages two and three of this manual you will see pictured the major features of the ball bearing truck kit. The back cover shows the bushing kit features.

BEFORE YOU BEGIN

Many people will feel the photos are detailed enough to think they will not need to read the instructions. This is not true. In addition to all of the photos there is important information to assemble your truck found only in the text. Even though you have the best truck kit available, if you want the best COMPLETED TRUCK then you will want to put it together correctly by following both text and photos.

This manual also covers two versions of the truck so you will also find sections that are specific to one version only. When possible we have combined the same steps for both versions. This was done to eliminate confusion and to show you how to correctly assemble the parts if you ever decide to upgrade your sport version.

Step 1 OPEN THE PARTS BAGS WHEN THE STEP SPECIFIES, NOT BEFORE, otherwise you'll get the parts mixed up and then you will have trouble assembling your truck. When you open each main bag for the first time, check the contents against the separate parts list sheet (accompanying the manual) for that bag. This sheet shows the contents of each bag by part number and quantity. All parts bags are referred to by number or name in the instructions. The unlabeled bags inside the main parts bags share the same bag number as the bag they came out of.

Step 2 KEEP THE PARTS SEPARATE. While building the truck you will sometimes be working with several bags at the same time. Try not to confuse the parts from one bag with the parts from another. Large paper plates (especially picnic plates with partitions) are ideal for both keeping parts separate and spreading them out where you can find them easier. Mark the plates with bag numbers and dump the parts into them. When the parts are used up, relabel the plate for the next bag.

Step 3 CHECK FOR SUPPLEMENTARY SHEETS

WHICH LIST NEW KIT UPDATES. Because Associated is constantly working on new ideas to improve our products, we occasionally make updates to our kits. These updates may not be covered in the instruction manual because the printed manuals cannot be immediately updated each time. These changes will be noted by supplementary sheets which explain which parts have been replaced or changed. So before you begin assembling your kit, please check each parts bag and the kit box to see if they contain these sheets. If so, locate the section of the manual where this change first applies and attach the sheets to that section so you will not forget them.

Step 4 ADDITIONAL ITEMS NEEDED TO OPERATE THE TRUCK:

- 2 Channel R/C surface frequency radio system
- Battery Pack (6 or 7 cell)
- Battery Charger (for 6 or 7 cell battery)
- Electronic Speed Control (ball bearing version only)
- R/C Motor (ball bearing version only)
- Pinion Gear (48 pitch); size will be determined by type of motor being used. (ball bearing version only)

Step 5 TOOLS. This kit contains the shock/turn-buckle wrench and the four Allen wrenches you will need to assemble the truck, but you will have to supply the following tools and adhesives to finish the assembly:

- Phillips screwdriver #2 (#SP-76)
- 1/8" straight blade screwdriver, for bushing kit only
- Needle-nose pliers
- Hobby knife, such as an X-acto knife with a pointed #11 blade
- Precision steel rule
- Soldering iron (40 to 50 watts), and a small amount of rosin (not acid) core 60/40 solder. We have found from experience that a pencil type soldering iron works better than the more common soldering guns. While the soldering guns generate a lot of heat, they have a hard time keeping the heat at the tip.
- Super Glue (cyanoacrylic glue) with safety gloves and goggles.

The kit can be assembled easier and faster with the following tools:

- Allen drivers (straight Allen wrenches with hex shaped aluminum handles), such as the following by Associated:
 - #G957 .050"
 - #G958 1/16"
 - #G959 5/64"
 - #G960 3/32"
 - #G961 2.5mm
- A 3/16" nut driver will make installing the ball ends and small pattern nuts easier (#SP-86)
- A 1/4" nut driver will speed up installing the 1/4" locknuts (#SP-85)
- A 11/32" nut driver will speed up installing the rear axle locknuts (#SP-82)
- Venier or dial calipers (with decimal or metric measure).

WARNING! Do not use a power screwdriver to install screws into nylon parts. The rotation speed is too fast, causing the screws to heat up when being driven into composites or nylon and they will strip out.

FINAL NOTES: (1) Experienced builders and racers: **please build the truck our way first!!** The T2 is a remarkably fast truck right out of the box. There's a good reason for everything on the truck, and very few compromises were made in its design. If you build it our way first you can see what the truck is capable of before you make changes and you will then have something to compare against. **(2)** Put a check mark in the box () at the beginning of each step after you finish it. Then when you stop during assembly, it will be easier to find where you need to continue from.

(3) Occasionally an actual-size drawing will accompany the photo to help you identify certain parts. You can place your part on top of the drawing to be sure you have picked up the right part. Also, you may end up with some spare parts and fasteners so don't worry. **WARNING! Only the drawings at the bottom of the photos are to true scale. None of the photos are actual size. Even though you may see dimensions marked in the photos, the photos are still not actual size.**

(4) We have used some special abbreviations throughout this manual for the various types of screws used. The following list identifies what the abbreviations stand for:

- FHMScrew: Flat Head Machine Screw. A standard thread screw which requires a Phillips screwdriver.
- FHSScrew: Flat Head Socket Screw. A standard thread screw which requires an Allen wrench or driver. The same type of tool is used for the two following fasteners:
- BHSScrew: Button Head Socket Screw. Requires an Allen wrench or driver.
- SHCScrew: Socket head Cap Screw. Requires an Allen wrench or driver.

(5) In order to keep a sense of direction when building the truck we use the following descriptions to standardize the right and left sides of the vehicle. The driver's or left side: with the driver sitting in the driver's seat, his left hand side is the driver's side. The passenger or right side will be the driver's right hand side. **(6)** The following types of special instructions, in *oblique*, will be used throughout the manual:

Racer's Tip: This is a trick used by some of the Team Drivers to improve their truck's handling, performance and maintenance.

Note: Alternate ways to assemble the kit, including tips for smoothing out difficult assemblies.

WARNING! This alerts you to be careful in order to prevent damaging the parts, and warns against using wrong parts or incorrect assembly that may reduce its performance.

SAVE THIS MANUAL! This is more than an instruction manual. It is also a handy supplement to the Team Associated 1:10 scale truck off road catalog. You can use the manual photos to help you identify part numbers and part names when ordering parts. In addition the manual can be used during a technical assistance call to Associated if you are

having assembly problems or have any questions. **Contact Customer Service at 714-850-9342.** Please remember, it's not a race to see how fast you can put your truck together; rather it's how well you put this truck together that will determine how well you race. **DON'T RUSH, TAKE YOUR TIME.**

Now clear off your workbench, line up some paper plates, grab a drink and a sandwich, and let's begin!



© 1996 ASSOCIATED ELECTRICS, INC.
3585 Cadillac Ave.
Costa Mesa, CA 92626

FRONT END ASSEMBLY

□ **Fig. 1** Before we start to assemble the front end, remove the #6955 shock/turnbuckle wrench and the #6950 tool bag (which contains the four Allen wrenches) from the kit master bag. Set them aside, we will be using them through out the assembly.

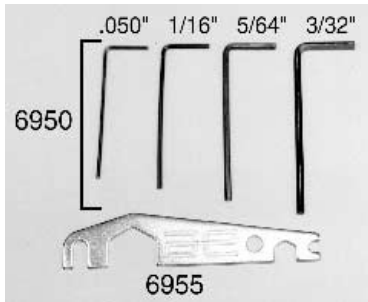

Fig. 1

□ **Fig. 2** (1) Find and remove bag #6-14. Now remove two #6273 long ball ends and two #7260 4-40 small thin plain nuts. (2) In the same bag you will find a thin flat piece of white foam with several donut shaped parts cut into the foam. These are our new #6272 foam ball end dust covers. We will be installing one of these over each ball end after it has been installed. (3) Now open bag #7-1 and remove the #6210 30° caster front carrier blocks. The carrier blocks are connected by a small molded runner which you will need to remove with your X-acto© knife. Be sure to remove all of the runner. (4) Screw one of the ball ends into each carrier block as shown (5) and then thread on the plain nuts. **NOTE: A 3/16" nut driver (#SP-86) will make installing the steel ball ends and small 4-40 nuts easier.** (6) Now install one of the foam ball end dust covers over each ball.



#6273
4-40

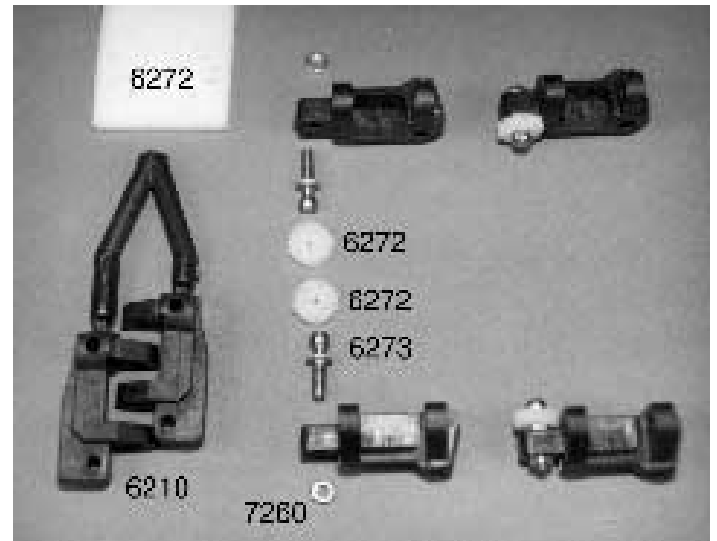

Fig. 2

□ **Figs. 3 & 4** (1) Go to bag #7-1 again and remove the two #6221 nylon steering blocks. At this point there is no right hand. or left hand block. (2) From bag #6-14 remove two of the #6273 long steel ball ends, two #6272 ball end dust covers, two #7260 4-40 small pattern thin plain nuts, and four #6936 #4 aluminum flat washers. (3) Place two washers onto each ball thread and then screw one ball end into each steering block as shown and then thread on the plain nut from the back side. (4) Take two more of the #6272 dust covers and install them over the two balls. Make sure the balls are mounted on opposite sides of the steering blocks so that they both will be on top of the steering blocks when mounted on the car. Once you have installed the ball ends on the steering blocks there will then be a right and left steering block.

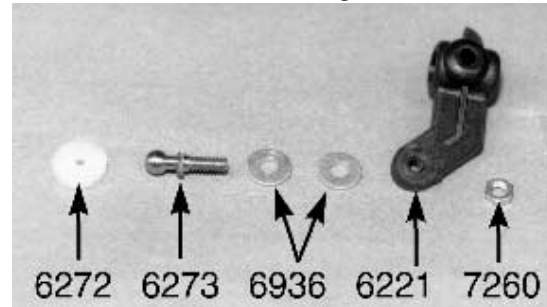

Fig. 3

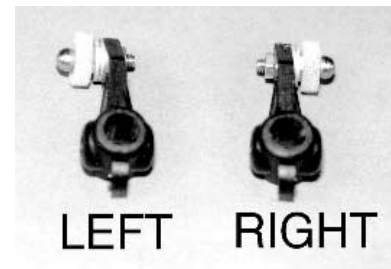
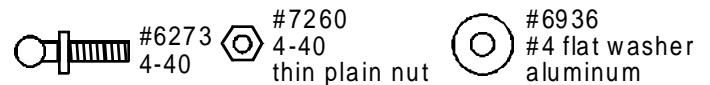

Fig. 4



□ **Fig. 5** You will find the two #6220 aluminum inline front axles in bag #7-1. Your axles will look like step 1. We are going to install one axle in each #6221 nylon steering block (step 2), making sure that the hole in each axle lines up with the hole in the steering block. The parts should push together with your fingers, if they do not, then you may fit a 1/4" nut driver over the threaded end of the axle, and then push the axle into the steering block (step 3). **WARNING! The threads on the end of the axle are aluminum and can easily be damaged by the nut driver.** When installed, the axle will be fairly tight in the steering block so try to align the two holes as you are assembling the parts. **WARNING!! Do not use pliers on the bearing surface of the axle. This can damage the axle surface so that the bearings will no longer fit. It is safer to push the axle out of the steering block and start the alignment process over if it will not turn.** Repeat the process for the second axle and steering block.

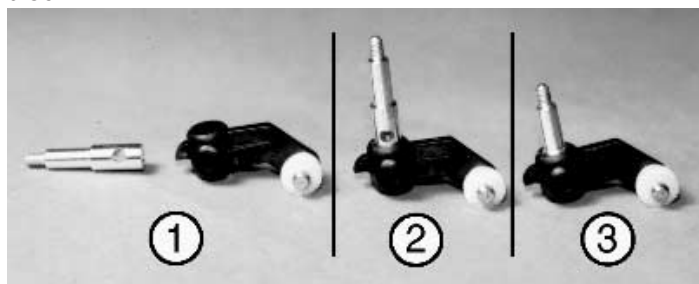

Fig. 5

□ **Fig. 6** In bag #7-1 you will find two #6223 kingpins. This bag contains several different length pins, so match the pins to the actual size drawing at the bottom. Now check that each kingpin will go through both steering blocks and axles. If you don't do this it will be almost impossible to get the kingpin to go through the #6210 carrier block and the steering block and axle when we assemble them. Once you have checked the fit of the kingpins remove them again.



Fig. 6

□ #6223

□ **Figs. 7, 8 & 9** (1) Take the two #6210 carrier blocks and install the steering blocks and axles into each one. Both steering block ball ends will be on the same side when installed correctly and the raised side of the angle on the bottom of the #6210 carrier block will be away from the ball

side. (2) Now reinstall one of the #6223 kingpins through each of the carrier block/axle assemblies as shown in figs. 7 & 8. Try to center the kingpins. (3) Fig.9 shows a package of #6299 1/8" E-clips that came from bag #7-1. They are rolled up and held together by a piece of tape. **The roll is so small and so easy to miss, you should actually look for the white tape instead of the E-clips.** Remove two from the package and install one on each end of the kingpin into the grooves at each end. (If you run out of E-clips, there are more in bags #7-8 and in the Shock Assembly parts bag.) (4) Now take out two more E-clips and install them on the other kingpin. We will use the remaining E-clips in the following steps.



Fig. 7



Fig. 8

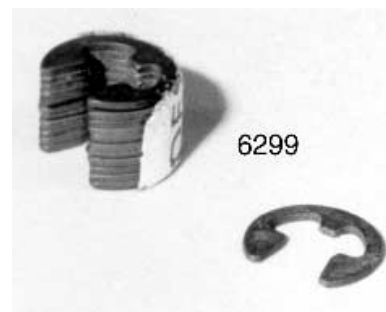

Fig. 9

#6299
e-clip
1/8 shaft

□ **Fig. 10** (1) In bag #7-1 are two small #6951 4-40 x 1/8" socket set screws. (2) Locate your #6950 tool bag. (3) Take out the smallest Allen wrench (.050") and use it to install the two set screws into the #6221 aluminum front axles. **Note: Our Associated #6957 .050 screwdriver handle Allen wrench would help here.** (4) Rotate the steering blocks in the block carriers so that you can see the threaded hole on the back side of the #6221 aluminum front axle. Slide one of the

set screws onto the .050 Allen wrench and carefully thread the set screw into the back of the front axle until it tightens down on the kingpin as shown in fig. 9. **(5)** Do the same with the other axle assembly.

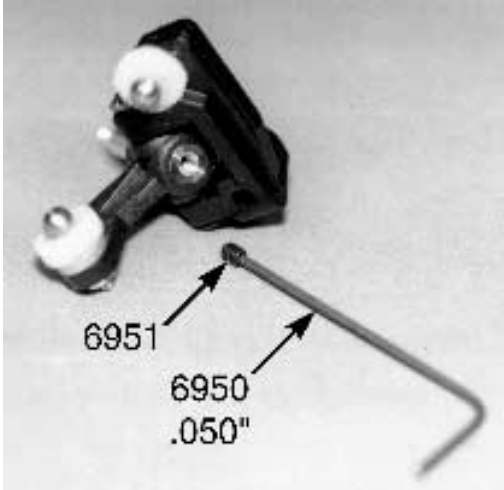

Fig. 10

#6951
set screw

Fig. 11, 12 & 13 Remove the bag containing the front and rear suspension arms. From this bag remove the two #7206 front suspension arms as shown in fig. 11. This photo shows you which arm is right (passenger side) and which is left (driver's side). It also shows you where to trim the runners from the arms.

(1) Use your pliers to remove the runners from both A-arms. **(2)** Use your hobby knife to remove any part of the runners remaining on the suspension arms. **(3)** From bag #7-1 locate the two #6227 outer hinge pins (match them against the scale drawing). Install one of the hinge pins through the holes in the outside end of the A-arm, hold the pin, and see if the arm will swing freely on the pin. **(4)** Using the same pin, check the fit in the #6210 left front block carrier. We want the pin to fit tight in the hole. **(5)** Now remove the outer hinge pin and install the left block carrier assembly into the left outer A-arm location using the #6227 hinge pin. **(6)** Install a #6299 1/8" E-clip on each end of the hinge pin. The ball ends will both be on the back (or straight) side of the A-arm when installed correctly. The #6210 block carrier will be angled towards the front as shown in fig. 13. **(6)** Now repeat the above steps for the right side A-arm. It will be a mirror image of the left.



Fig. 11

#6227

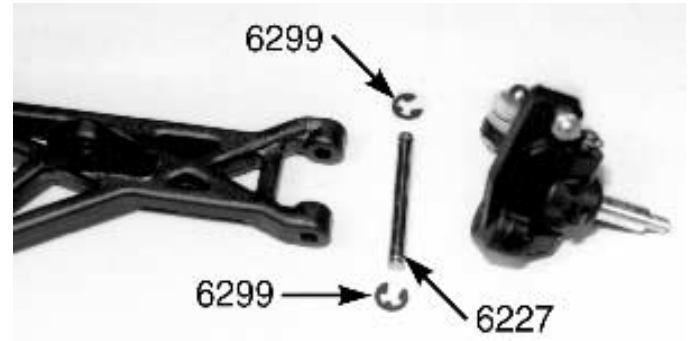

#6299
e-clip
1/8 shaft

Fig. 12



Fig. 13

Fig. 14, 15 & 16 Go back to bag #7-1 and remove the #7207 front bulkhead, the #7208 front bulkhead aluminum support, and the two #7209 front inner hinge pins. Match the hinge pins to the scale drawing. Fig. 14 shows you the front bulkhead alone to make it easier to identify the front and back sides of the bulkhead. Check the fit of the #7209 hinge pins in the A-arms the same way we did in fig. 12. Free them up if necessary. We want the pins to be tight in the front bulkhead but free in the arms.

(1) Starting with the left A-arm, install the inner hinge pin from the back side through the back half of the A-arm and the #7207 front bulkhead. **(2)** Now line up the #7208 aluminum bulkhead support between the front side of the bulkhead and the front of the left A-arm. Push the hinge pin the rest of the way through. **(3)** Secure the hinge pin with a #6299 E-clip on each end. **(4)** Now assemble the right side suspension the same way. Fig. 16 shows the front bulkhead assembly completed.



Fig. 14

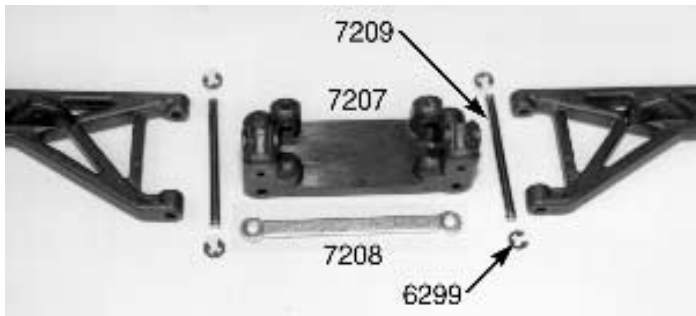

Fig. 15

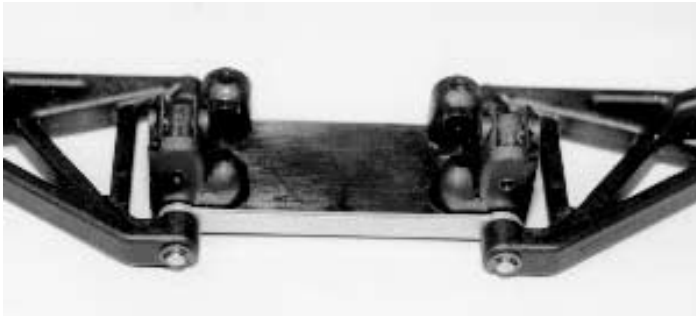
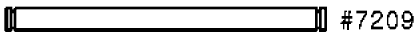

Fig. 16



□ **Figs. 17, 18 & 19** (1) From bag #6-14 remove two #6270 short steel ball ends, two #7260 4-40 small pattern thin plain nuts, and two of the #6272 foam ball end dust covers. (2) Now take the #7215 black fiberglass front shock strut and two #6925 4-40 x 1/2" SHCScrews from bag #7-1. (3) Install the #6270 short ball ends in the two holes outside of the small oval shaped holes as shown. At this time it does not matter which side of the shock strut you use. Tighten the ball ends (4) then install and tighten the two plain nuts on the ball ends. (5) Install the dust covers over the balls now. (6) Go back to your #6950 tool bag and take out the largest Allen wrench (3/32"). (7) Use the two #6925 SHCScrews and the 3/32" Allen wrench to mount the #7215 shock strut on the back side of the #7207 front bulkhead, making sure that the ball ends are on the back side facing away from the bulkhead (see fig. 15). **Note:** All of the 4-40 SHCScrews in the kit can be installed with the 3/32" Allen wrench supplied in the #6950 tool bag. But an Associated #6960 3/32" Allen driver (or an equivalent brand) will make installation of the same screws easier and quicker.

(8) Inside the master shock bag are bags #7-9, #7-10, and the shock assembly parts bag. From the master shock bag find and open bag #7-10 (the front shock bag). (9) Open the miscellaneous hardware bag that is inside bag #7-10 and remove two each #6927 4-40 x 3/4" SHCScrews, #6295 4-40 plain nuts, and #6936 #4 aluminum flat washers. (10) Install and tighten the #6927 SHCScrews in the outer hole at the top of the front shock strut (see fig. 19). Install the screws from the back side so the screw heads are on the same side as the ball ends. (11) Now place a flat washer over the threads of each screw. (12) Next install and tighten a plain nut onto the threads of each screw as shown (see fig. 16). If everything is installed correctly the threads will be on the front side of the shock strut extending over the front bulkhead.

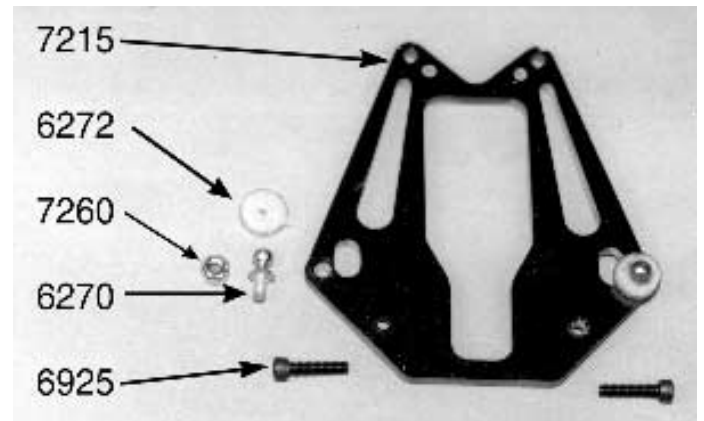

Fig. 17

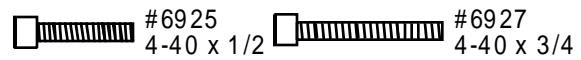
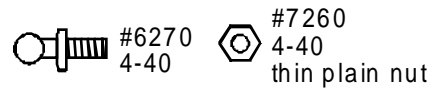

Fig. 18



Fig. 19



□ **Fig. 20** In bag #6-14 you will find fourteen #6274 plastic ball cups on a molded tree. In bag #7-1 you will find two #7253 2.62" long turnbuckles; remove four of the ball cups and thread them onto the turnbuckles evenly until you adjust them to the 2 15/16" (2.94" or 74.60mm) dimension shown below. We have also included a scale drawing of the turnbuckle parts and assembly with ball cups installed. **THESE DIMENSIONS ARE TO THE CENTER OF EACH BALL CUP, NOT TO THE END OF EACH BALL CUP.** The ball cups face the same direction when installed. The turnbuckles have right hand threads on one end and left hand

threads on the other end, so they will screw on in different directions. This will allow us to simply turn the turnbuckles (from the hex center section) with the #6955 shock/turnbuckle wrench to make adjustments.

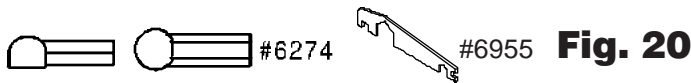
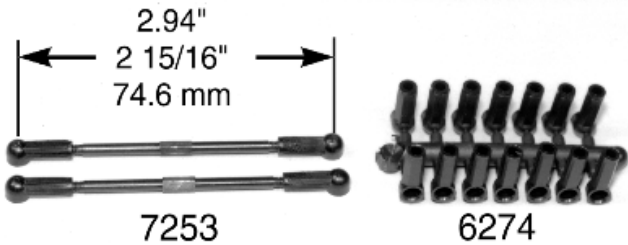
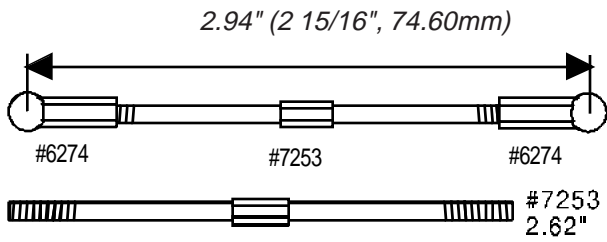

Fig. 20

□ **Fig. 21** Using a pair of slip joint or needle nose pliers, snap the ball cups onto the steel ball ends as shown.



Fig. 21

□ **Fig. 22** The plastic ball cups can be removed quite easily from the balls by holding the ball cups close to the ball, as shown, and twisting the ball cup off of the ball end as fig. 22 shows.

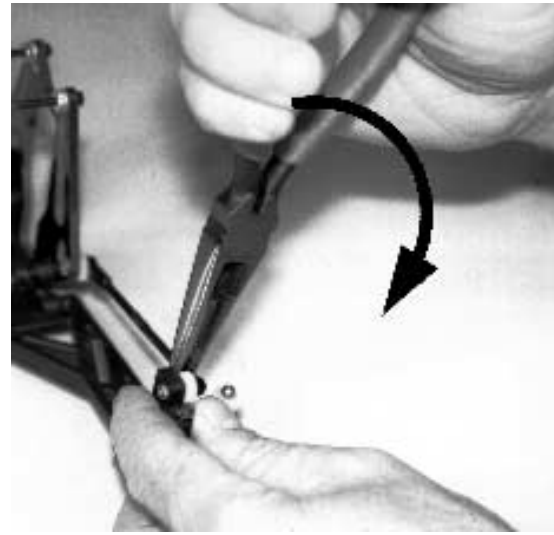

Fig. 22

□ **Figs. 23, 24 & 25** (1) Open bag #7-4 and remove the #7305 black aluminum chassis nose plate. (2) Back in bag #7-1 you will find four #6280 8-32 x 1/2" aluminum FHMScrews. (3) Using a #2 Phillips screwdriver we are going to install the front bulkhead assembly to the #7305 nose plate. Insert one of the #6280 FHMScrews through the bottom of the nose plate and line it up with the appropriate hole in the bottom of the front bulkhead (see fig. 24). Do not tighten the screw all the way down. (4) Now install the other three #6280 FHMScrews the same way and then tighten down all four screws. DO NOT OVERTIGHTEN, otherwise you will strip out the nylon. When you are done your front end will look like fig. 25.

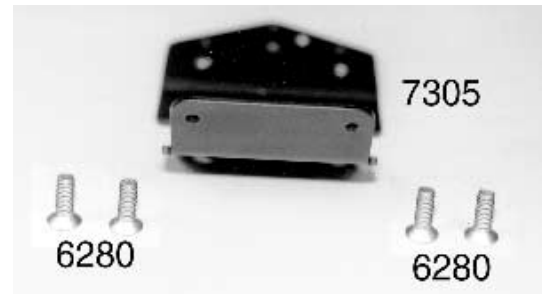

Fig. 23

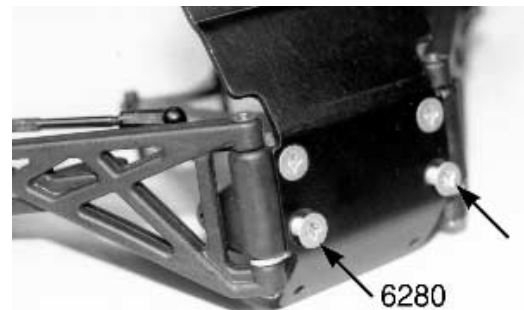

Fig. 24



 #6280
8-32 x 1/2
aluminum

Fig. 25

□ **Fig. 26** Now remove the #7301 truck black hard anodized aluminum chassis from the kit box. **Note:** If you are familiar with our products you will see that this is a new chassis design using our new aircraft aluminum alloy. The chassis has been engineered to improve the rigidity of the chassis for both front to rear and side to side. It also features improved chassis side roll clearance for rougher tracks.



Fig. 26

□ **Figs. 27 & 28** (1) From bag #7-4 remove the silver colored #6931 8-32 x 1/4" steel FHMScrew (this screw is also part of the #7306 servo saver replacement screw set). (2) Now open up bag #7-2 and remove the two #7306 special black steel servo saver screws. These two screws are different lengths, with a short threaded shank by the screw head, a smooth center shaft and then a smaller threaded end.

(3) Now line up the #7305 black anodized aluminum nose plate with the front end assembly over the front of the chassis as shown in fig. 27. (4) There are three holes in the chassis and six holes in the nose plate. Starting with the 1/4" FHMScrew we are going to install it from the bottom of the chassis using the center hole of the chassis holes and thread it into the forward center hole of the nose plate. Do not tighten this screw completely just yet. (5) Now install the longer of the #7306 screws into the left front hole of the chassis (from the bottom). It will then thread into the left forward hole of the nose plate if you have everything lined up correctly. Again do not tighten this screw yet. (6) Now you can install the shorter #7306 screw into the right front hole of the chassis and into

the right forward hole of the nose plate. (7) When everything looks lined up and threaded correctly you can then finish tightening up the three screws as shown in fig. 28.



Fig. 27

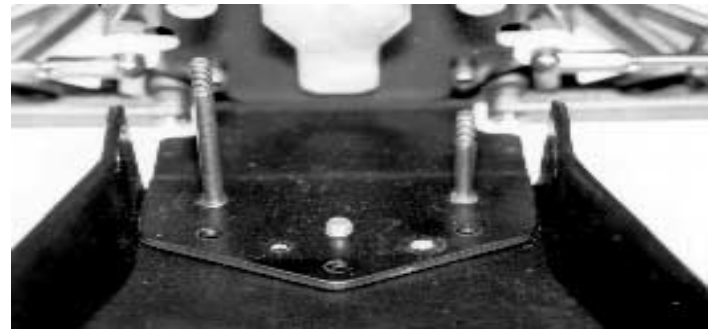

 #6931
8-32 x 1/4
steel

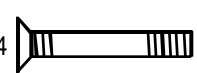
 #7306
7/8
special

 #7306
1 3/8
special

Fig. 28

□ **Fig. 29** Inside the same bag #7-2 you will find the #7531 black plastic servo saver parts tree and the #9156 aluminum servo saver tube. The names of the parts on the parts tree are: (1) left upper servo saver arm, (2) lower servo saver bushing, (3) upper servo saver bushing, (4) left lower servo saver arm, (5) right side bellcrank. Remove the two servo saver bushings and install them into the servo saver tube. The upper bushing goes into the threaded end of the tube and the lower bushing goes into the hex end of the tube.

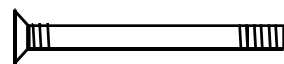
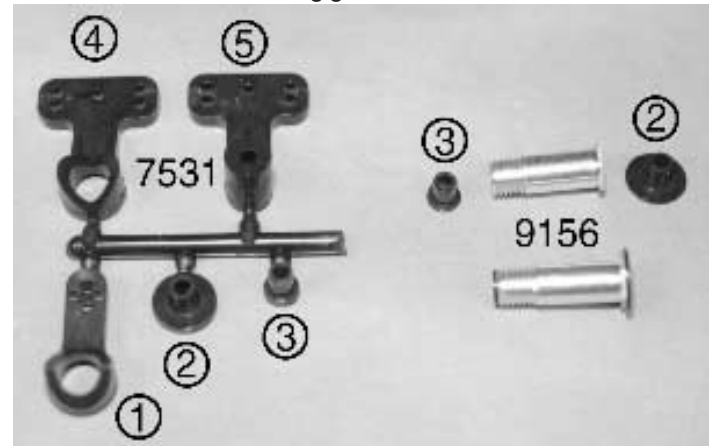

Fig. 29

□ **Figs. 30 & 31** (1) Take out the #9157 servo saver spring and the #9157 aluminum spring adjusting nut from bag #7-2. (2) Now remove the lower left servo saver arm from the parts tree. (3) Before we install the lower servo saver arm over the aluminum tube, look at the bottom of the arm. You will find a recessed hex shaped area that will match up with the hex portion at the bottom of the aluminum tube. Slide the lower servo saver arm over the aluminum tube and push it down until the tube hex fits into the hex shaped recess. (4) Next we need to remove the upper servo saver arm. Install it over the tube with the "V" shaped portion facing down into the "V" groove of the lower arm. Make sure the upper arm is facing to the right (with the lower arm facing away from you) as shown in the photo. **Racer's Tip:** Team drivers coat the V-groove portion of the servo saver with a small amount of #6588 black grease to improve the servo saver performance. **Note:** Some servos may not fit, we will discuss these later in the instructions when we are installing the steering servo.

(5) If you look at the top of the upper left servo saver arm (after it is installed onto the aluminum tube) you will see there is a recessed area. Slide the #9157 spring over the aluminum tube and into the recessed area. (6) Look closely at the spring adjusting nut. You will see that one side of this nut also has a recessed area. Slide the nut over the tube, recessed side first, and thread it onto the tube. (7) Tighten the nut until 1/32" of the tube threads are exposed above the adjusting nut. **Racer's Tip:** You can adjust the servo saver tension by tightening or loosening the aluminum adjusting nut. This changes the tension on the servo saver spring. The more you tighten the servo saver spring, the more load you transfer to the servo gears. The adjusting nut should only be below the initial setting under limited racing conditions on an extremely high traction surface.

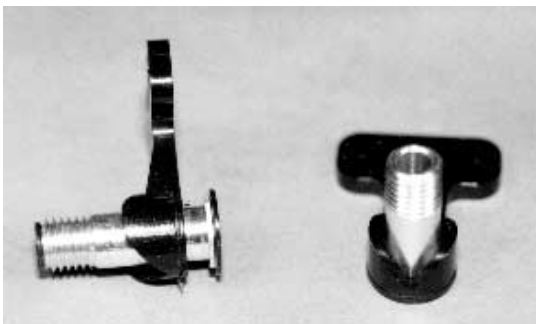

Fig. 30



Fig. 31

□ **Figs. 32 & 33** Now we need to go back to bag #6-14 and remove five #6270 short steel ball ends and four #6272 foam ball end dust covers. Layout the left servo saver arm assembly and the right bellcrank as shown in fig. 32. Now we need to thread the five ball ends into the servo saver and bellcrank per the photo. After all the ball ends are installed you can then push the #6272 foam dust covers over the front four ball ends. You will not be installing a foam dust cover over the servo tie rod ball end. **Note:** You do not need to install nuts on the bottom of these five ball ends.

Now remove the #6265 molded drag link from bag #7-2. We want to install the drag link between the servo saver arm and bellcrank as shown in fig. 33. Snap it over the center balls on both bellcranks using needle nose pliers.

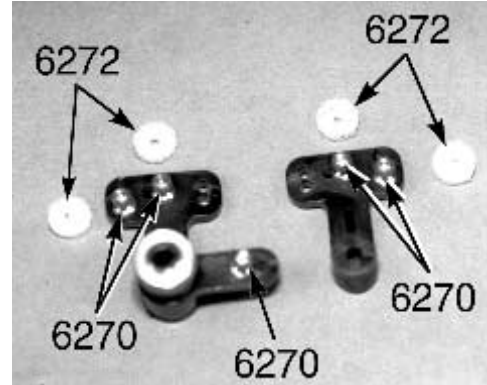

Fig. 32

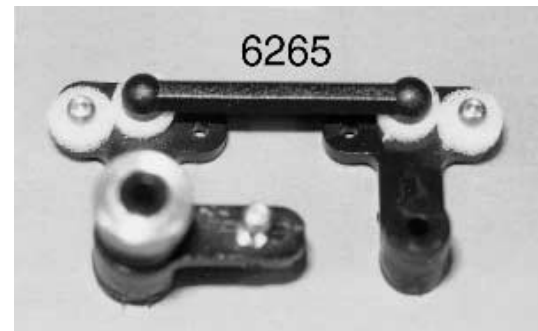
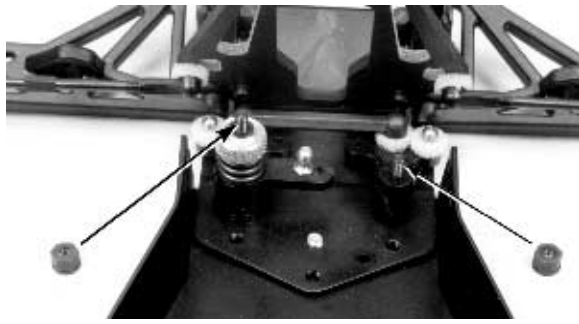

Fig. 33

□ **Fig. 34** Slip the completed servo saver assembly down onto the two #7306 servo saver mounting screws (that bolt the nose plate assembly to the chassis). This will put the left hand servo saver arm on the longest screw with the servo arm facing the center of the truck. From bag #7-2 take out two #6222 4-40 black self threading nylon locknuts. Thread one onto each of the servo saver mounting screws. Tighten the nuts down just enough to remove any excess up and down play in each servo saver arm, but **NOT TOO TIGHT**. The servo saver arms should be able to swing to the left and right very freely. The servo saver arms should also be parallel when installed.



 #6222
4-40/5-40
nylon locknut

Fig. 34

□ **Fig. 35 & 36** From bag #7-4 remove the two #7315 black anodized nose brace tubes. Also remove two #6925 4-40 x 1/2" SHCScrews and two #6285 4-40 x 1/4" SHCScrews. Look closely at a nose brace tube. You will see that one tube end has one hole closer to the end of the tube than the other and that it is an unthreaded hole. Slip the end with the unthreaded hole towards the front of the truck, through the oval shaped hole on the passenger side of the black front shock strut. Align the hole in the tube with the hole in the saddle of the front bulkhead. Install one of the #6925 4-40 x 1/2" SHCScrews in the front hole but do not tighten it down all the way. Now line up the back hole in the nose brace tube with the back hole on the front side of the chassis install the #6285 SHCScrew. Now go back and do the same for the other nose brace tube. Fig. 36 shows the front of the chassis showing the four mounting hole locations with the screws installed. After both tubes and their screws have been installed you can tighten all four screws. Be sure not to overtighten the screws.

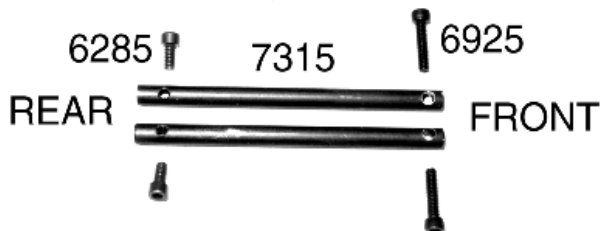
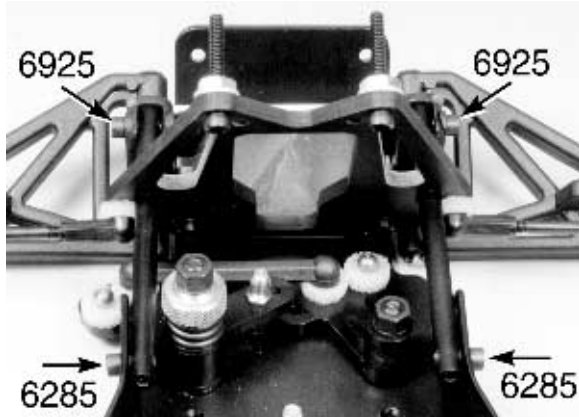



Fig. 35



 #6925
4-40 x 1/2

 #6285
4-40 x 1/4
steel

Fig. 36

□ **Fig. 37** In bag #7-2 you will find two #7253 2.62" turnbuckles. From bag #6-14 remove four #6274 ball cups. Thread the ball cups onto each end of the two turnbuckles. Remember the turnbuckles have both right and left hand threads, and on one end of each turnbuckle the ball cup will thread on the opposite way. The drawings with this step show the actual assembled dimension with the ball cups and the actual length of the #7253 turnbuckle. On these two turnbuckles (when assembled) the ball cups all face the same direction.

Using your needle nose pliers install both of the steering turnbuckles onto the servo saver ball ends and the steering arm ball ends as shown in fig. 39.

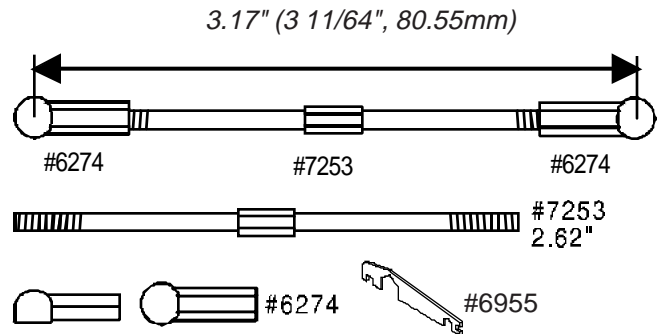

Fig. 37

□ **Figs. 38, 39 & 40** (1) Locate bag #7-5 and remove the black nylon body mount tree. Fig. 38 shows the location of the front and rear body mounts on this parts tree. Remove the two #7319 front body mounts. (2) Go back to bag #7-5 and remove the #7318 front body mount brace and the two #6918 4-40 x 1/2" BHSScrews. (3) Use your #6950 1/16" Allen wrench from the Tool bag to mount the front body mounts to the front body mount brace, as shown in fig. 39, with the two #6918 screws. **Note:** To hold the front body mount while you are tightening the screw you can use one of the #6332 body clips (hood pins) installed in its mounting hole to hold the mount. (4) Align the small body clip holes in the ends of the body mounts so they point to the left and right. (5) Tighten the screws but not too tight.

(6) Now we need to install the front body mount brace assembly onto the front bulkhead. Take two #6924 4-40 x 3/8" SHCScrews from bag #7-5. Install the body mount brace over the front bulkhead, facing towards the back. This will put the body mounts over the bulkhead as well and they will be

pointing straight up, not at an angle, when installed as shown in fig. 40.

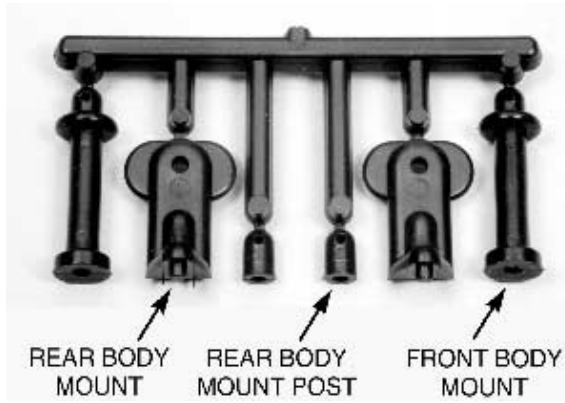

Fig. 38



Fig. 39

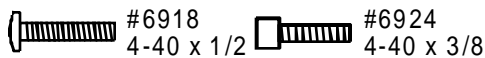
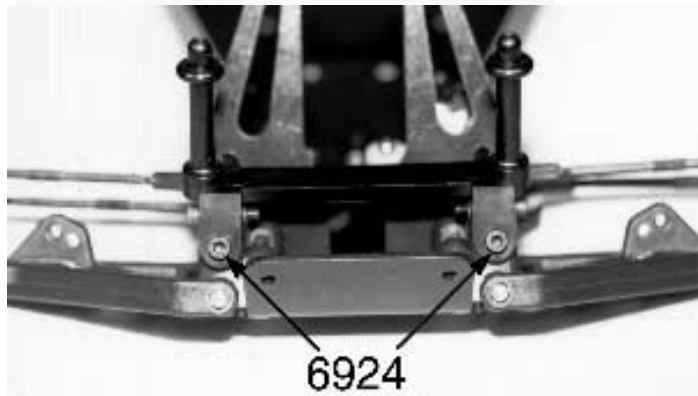

Fig. 40

□ **Figs. 41 & 42** You will find the #7324 front bumper in bag #7-4. Take two #6291 4-40 x 1/4" FHSScrews and two #6295 4-40 plain nuts from the same bag. The front bumper is recessed on one side so it will fit over the black aluminum nose plate. The front of the bumper has two countersunk holes where you will install the two #6291 flat head screws. Now thread on the two #6295 4-40 plain nuts on the back side of the nose plate and tighten them down.

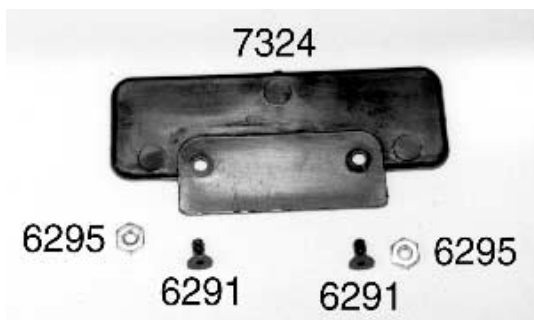

Fig. 41

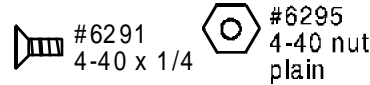

Fig. 42

2.60:1 T2 STEALTH TRANSMISSION

The new T2 Stealth is our latest electric truck version of the Stealth Transmission and features a larger differential which gives you a final drive ratio of 2.60:1. This transmission also features a new low profile case design, which physically bolts to the rear shock strut and bulkhead to add additional structural rigidity to the rear of the chassis and drive train. The larger diff gives you greater torque capacity and increases time between rebuilds. The prototype version of this transmission was first used at the 1994 ROAR Truck Nationals held in Garden Grove, California. It TQ'd both stock and modified truck classes and won the Stock truck A-main.

This lower final drive T2 Stealth transmission will now allow you to run hotter modified motors than before. Now you can have that extra power that you wanted in order to more easily defeat your competition. With this transmission your new truck will be more reliable and easier to drive. This all depends, of course, on how well you assemble and maintain your transmission. So take your time and do it well.

Please note that during the assembly of the transmission we will be using the same instructions to sow the assembly of both the bushing and ball bearing version kits. The only parts that will be different will be bag B which will contain either the bushings or ball bearings depending upon the kit you have. If you are uncertain which kit version you have, the description on the box end label underneath the retail price and model number will indicate if you have ball bearings.

□ **Fig. 43 (1)** Open the Stealth transmission bag; inside you will find bags marked A, B, C, D, E & F. You will also find a gear cover bag, the motor plate and a couple of small tubes of lube. **(2)** Go ahead and locate bag A, the diff assembly. **(3)** From bag A you will want to remove the #7664 diff gear and the small bag containing the twelve #6581 3/32" carbide diff balls (these are the larger of the two ball sizes). These carbide balls are the best available. They will outlast the diff drive rings at least ten times (if the diff is kept clean and lubed).

WARNING! NEVER replace your diff balls with

any other balls except our #6581 carbide diff balls The tolerances we use are tighter than most other companys'. Due to these tight tolerances and careful packaging of matched balls, when replacing lost or worn 3/32" diff balls, you MUST replace ALL 3/32" balls at the same time with new balls from the same package. This means you cannot even mix balls from two separate #6581 packages.

(4) Look at the center hole of the #7664 diff gear. If there is any flash on the inside hole you must remove it. Take your X-acto® knife and carefully trim the flash from the center hole. You can make sure you do not remove any of the gear itself by using the tip of the X-acto® blade, which turns easier in the hole when removing the flash.

(5) From the Stealth transmission bag remove the #6591 Stealth silicone diff lube tube. Another word of caution. DO NOT substitute any other type of diff lube on the balls. It took us countless hours of testing to find the correct silicone diff lube to make the diff work correctly. Do yourself a favor: Use what comes in this kit! **WARNING! Do not use the #6588 black grease on the #6581 3/32" diff balls.** Fill the twelve ball holes in the diff gear with silicone diff lube (6) and then push the twelve #6581 3/32" balls into the holes. (7) Wipe the excess lube back into the ball holes with your finger. Fig. 45 shows your completed diff gear. (8) Carefully clean all of the silicone grease off your hands.

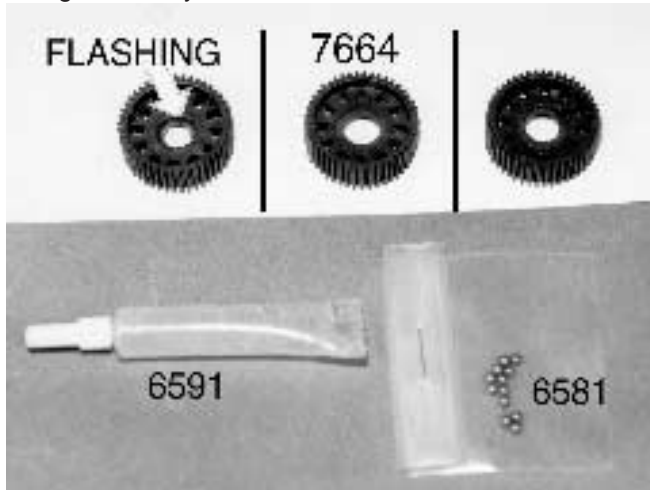

Fig. 43

□ **Figs. 44 & 45** (1) Next open bag B, from the Stealth transmission bag. (Remember this will be the only transmission bag that will be different between the different kit versions) If you have a ball bearing kit you will be using the parts and part numbers shown on the left side of fig. 44. If you have a bushing kit you will be using the parts and part numbers shown on the right side. All kits (bushing and ball bearing) will use a #6596 bushing for the torque clutch. If you have a ball bearing kit you will have eight bearings and one bushing while the bushing kits will have nine bushings. **Note:** All the bushings used in the kit are pre-oiled through a special manufacturing process, so no oil is needed on the bushings during the assembly. In this bag you will find a total of eight bearings and one bushing. (2) Remove one of the #6589 5/32" x 5/16" unflanged ball bearings or one of the #6597

5/32" x 5/16" unflanged bronze bushings. **WARNING!! On bushing kits both the #6596 and #6597 bushings have the same outside diameter; only the inside diameter is different. Do not use the larger inside diameter bushing for this step. If you do, the torque clutch will not go together later in the assembly and you will have to take the transmission and differential apart again to switch the #6596 for the correct #6597 bushing.** (3) Place the #6589 ball bearing or #6597 bushing into the center hole of the #7664 differential gear as shown in fig. 45.



Fig. 44



Fig. 45



□ **Figs. 46, 47, 48 & 49** (1) In bag A you will find the molded #6575 T-nut and diff thrust bolt cover (see fig. 46). (2) Trim the two parts from the nylon runner. We will use it near the end of the transmission assembly. **WARNING! Make certain that you do not cut off the "ears" on the T-nut or the thrust bolt cover. The ears are needed to prevent the parts from spinning freely in the outdrives.** For now set the diff thrust bolt cover aside; we will use it near the end of the transmission assembly.

(3) Now remove the #6582 diff thrust spring and the #7668 left diff outdrive hub (the one with the small nipple on it) from the same bag A. **WARNING!! Please make sure you do not get the #6582 diff thrust spring mixed up with the #6587 torque control spring (from bag E) used later during the assembly. The torque control spring has a slightly larger outside diameter and will jamb inside the diff outdrive hub if forced in.** Now check to make sure that there are no burrs or residue on the inside or outside, of the

diff outdrive hub, which could damage parts or reduce the performance of the diff. Slide the diff spring into the left diff outdrive hub. It should slide in or go in with very light pressure until the spring reaches the bottom of the outdrive hub cavity. (4) Next align the T-nut with the slots in the outdrive hub and push it in. Make sure the steel insert side goes in first. This will place the T-nut "ears" on the outside away from the diff spring. Slide the T-nut all the way down against the spring.

(5)(Fig. 48) The ears on the T-nut should be approximately 3/32" or a little less than .100" from the bottom of the slot. Take your X-acto knife and trim off any of the plastic T-nut that extends outside both sides of the slot in the outdrive hub. The diff outdrive hub will not fit through the ball bearing in the case if we do not take care of this now. **WARNING!! Be careful here so that you do not cut yourself, since you will be cutting towards your thumb.**



Fig. 46



Fig. 47

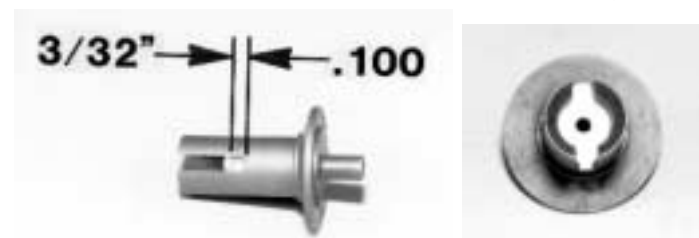

Fig. 48

Fig. 49

□ **Fig. 50** (1) In bag A you will also find a little bag containing the six smaller #6574 5/64" precision thrust balls. In another little bag you will find the #6575 2-56 diff thrust bolt and the two #6573 (special hardened steel washers) diff thrust washers. **WARNING! NEVER replace your thrust balls with any other balls except our #6574 thrust balls. The tolerances we use are tighter than most other companys'. Due to these tight tolerances and careful packaging of matched balls, when replacing lost or worn 5/64" thrust balls, you MUST replace ALL 5/64" balls at**

the same time with new balls from the same package. This means you cannot even mix balls from two separate #6574 packages.

(2) Slip one of the #6573 diff thrust washers onto the #6575 diff thrust bolt as shown. **Racer's Tip: Carefully look at the center hole of the first thrust washer; you will be see that each side is beveled. One side is beveled more than the other; This side is installed towards the head of the thrust bolt. This will help to insure that the thrust assembly will work as smoothly as possible.** (3) Go back to the Stealth main bag and locate the tube of #6588 black grease. (4) Open the tube and place a small amount on the washer. Use just enough grease to hold the six balls in place on the washer. **WARNING! Do Not use the #6591 Stealth diff lube on the six #6574 5/64" diff thrust balls.** (5) Now carefully place the six #6574 balls in the grease around the washer. (6) Slide the second washer onto the bolt until it contacts the balls. **WARNING!! Make sure that you have exactly six thrust balls installed between the washers. More than six will cause the diff to back off and less than six can cause the thrust washers to crack.**

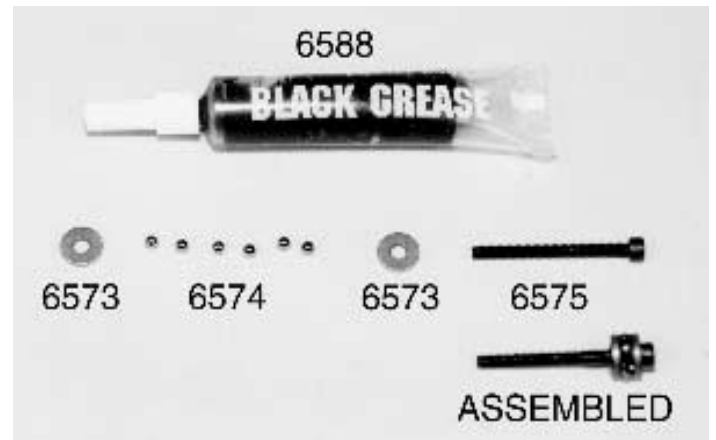

○ #6573 □ #6575

Fig. 50

□ **Fig. 51** (1) Remove the #7667 right diff outdrive hub and one of the #7666 diff drive rings from bag A. Go back to bag B and take out the second 5/32" x 5/16" #6589 unflanged ball bearing or #6597 5/32" x 5/16" unflanged bushing (remember these parts are determined by which kit you purchased). Now check to make sure that there are no burrs or residue on the inside or outside of the right diff outdrive hub which could damage parts or reduce the performance of the diff. (2) Install the #6589 bearing or #6597 bushing into the cavity in the center of the right diff hub. It should just push in with your finger. **Never drive or force the bearing or bushing into the hub cavity!** (3) Now place the #7666 diff drive ring onto the right diff hub. **Racer's Tip: The Team Drivers always check the diff drive rings for the side that is more rounded on the edge and place this side against the hub which will give you the best diff action possible. Do not try to pin the drive ring to the hub. This hub and ring system are designed to lock the drive ring without pinning. Please leave it AS IS.**

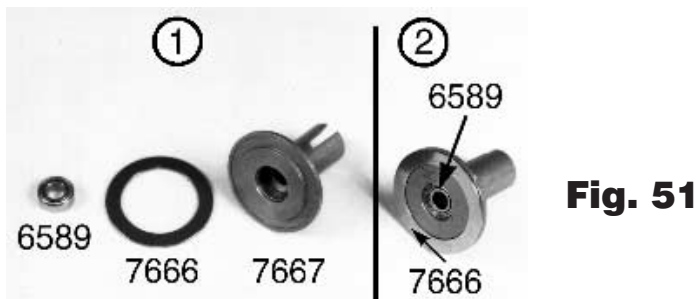



Fig. 51

 #6589
5/32 x 5/16
unflanged bearing

□ **Fig. 52** Go back to your #6950 tool bag and remove the 5/64" Allen wrench. Slide the long end of the Allen wrench into the head of the #6575 diff thrust bolt. We will be inserting the bolt, washers, and thrust balls into the center of the #7667 right diff outdrive hub, as shown. **Note:** Associated's #6959 5/64" Allen wrench will work well here.

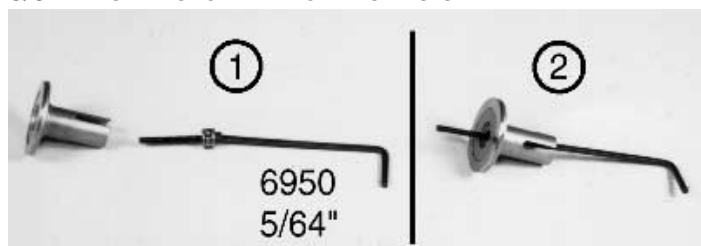

Fig. 52

□ **Fig. 53** With the Allen wrench still in the head of the diff bolt, turn the hub assembly upright so that the wrench is on the bottom. Make sure that the #7666 diff drive ring is still on and centered. Now pick up the #7664 diff drive gear with the balls and bearing installed and slip it over the #6575 diff thrust bolt onto the drive ring and hub. We want to center it on the diff drive ring on the right diff hub.

Now go back to bag A and take out the second #7666 diff drive ring. We are going to install this second drive ring on the top side of the diff gear over the diff balls and center it as best as you can. **Note:** In the photo for fig. 53 we have removed the Allen wrench so that you can see the diff gear before the #7666 drive ring is installed and as it is being installed. Remember, if you are doing the racers setup the rounded side will be up. **WARNING!** If you remove the gear at any time before you completely assemble the diff halves always double check to make sure you do not have both drive rings on the same side. This can be easy to do because one drive ring may stick to the diff gear and the other could be stuck to the diff outdrive hub.

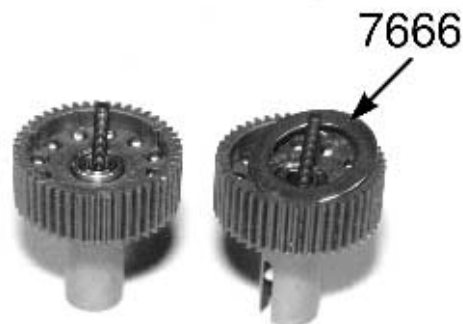

Fig. 53

□ **Figs. 54 & 55** (1) With the Allen wrench still in the diff bolt, turn the right hub so that the end of the bolt is facing up. **WARNING!!:** Make sure you securely hold the Allen wrench in the head of the diff thrust bolt. This will prevent the bolt, washers and possibly the diff thrust balls from falling out during assembly and possibly getting lost. (2) Now we are going to install the #7668 left diff drive hub assembly over the #6575 diff bolt until it seats on the #7666 diff drive ring (as shown in fig. 54). When picking up your left diff hub place your finger over the slotted end of the hub so that the T-nut and spring cannot fall out. Make sure that the outdrive hub centers on the top diff drive ring when it fits into the center of the diff gear. (3) While holding the upper diff hub, tighten the diff bolt using the Allen wrench. Please make sure the hubs and diff drive rings stay centered. (4) Once you have lightly snugged the two halves together you can turn the diff assembly sideways, as shown, to make the final adjustment easier (see fig. 55). Hold the left hub and tighten the screw until it stops. This will fully compress the diff spring under the T-nut. **DO NOT OVERTIGHTEN.** Correct adjustment is tightening the diff bolt and spring until the stop, then backing the bolt off 1/8 of a turn.

When the adjustment is finished the diff should be tight but the operation of the diff should feel smooth when turning the hubs in opposite directions. Remember this is not a free spinning component. We are looking for the ball rolling motion to feel smooth not rough. **Note:** After you have run the car once, you will need to recheck the diff adjustment. The first run makes sure that all the parts seat correctly. After you have rechecked the diff adjustment it should only be necessary to check the diff adjustment occasionally.

ADJUSTING THE DIFF: As you are tightening the diff bolt, you will notice the ears on the T-nut moving closer to the bottom of the slot in the left diff outdrive hub. This causes the diff spring (under the T-nut) to compress. The spring and diff bolt should stop about the same time as the T-nut ears reach the bottom of the slot. If it is only off by a small amount, there is no problem. Bottoming out the spring and bolt is very important. The tension of the spring can only be consistent if you start from the same point each time. A fully compressed spring is your starting point. This way, when you back off the bolt 1/8 of a turn you will always have the same spring tension, so your diff will be consistent. We again

want to remind you that this diff is not designed to slip. We use the torque clutch to control any slippage the truck needs. This is why the wrong diff lube or silicone compound can allow the diff to slip. This would reduce the transmissions performance and increase the parts wear.



Fig. 54



Fig. 55

□ **Figs. 56 & 57** (1) Open bag C and remove the #7375 left and right T2 Stealth transmission case halves. (2) The two case halves are attached, by a mold runner. On the mold runner will be the three #7375 motor plate spacers. Remove the runner and motor plate spacers, for now. We will use them after a few more steps. (3) Remove any flashing from the case halves. (4) Now go back to bag B. If you have a ball bearing kit, remove four #6906 3/16" x 3/8" unflanged ball bearings and two #6903 3/8" x 5/8" unflanged PTFE sealed ball bearings. If you have a bushing kit you will be removing four #6599 3/16" x 3/8" unflanged bushings and two #6598 3/8" x 5/8" unflanged bushings. The photo in fig. 57 shows the bearings installed in each case half but the bushings will install the same way.



Fig. 56



Fig. 57



□ **Figs. 58, 59 & 60** (1) Open bag D and remove the #6571 drive shaft/gear assembly and the two #7669 drive shaft spacers. Carefully check both sides of the roll pin hole in the drive gear/shaft and make sure there are no burrs in the hole or raised edges around the hole. If there are, carefully deburr the hole and remove any raised edges. We are trying to make sure that the hole is not blocked when we go to install the roll pin in the next couple of steps. We are also trying to make sure that the bushing or bearing will be able to slide all the way onto the shaft. Now take the #6571 drive gear and push one of the #7669 spacers onto the threaded shaft end all the way down against the gear.

Insert the shaft through the upper bearing of the #7375 right transmission housing half so that the shaft is facing out to the right and the gear is inside against the bearing as shown in fig. 60. Take the second #7669 drive shaft spacer and install it onto the outer end of the drive gear shaft. Slide it all the way down next to the drive gear.



Fig. 58

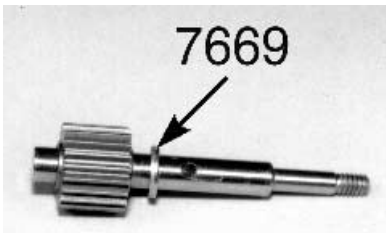

Fig. 59

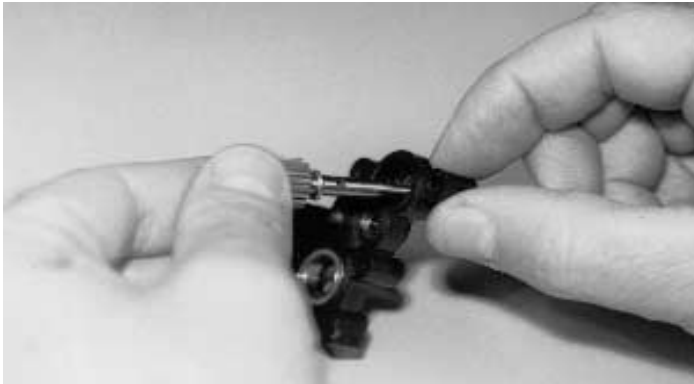

Fig. 60

□ **Figs. 61 & 62** Open bag E and remove the #6572 3/8" long roll pin. Now using a pair of needle nose pliers squeeze the roll pin into the hole in the #6571 drive shaft and center the pin to the best of your ability (see fig. 62). *Racer's Tip: You can use your needlenose pliers to gently close the split on one end of the roll pin. This slightly smaller end will then be easier to get started into the roll pin hole.*



Fig. 61



Fig. 62

≡ #6572
roll pin

□ **Figs. 63, 64 & 65** We are now going to install the other gears into the right transmission housing. (1) First we need to install the second #7669 drive shaft spacer onto the outer end of the #6571 drive shaft/gear assembly. (2) now pick up your differential assembly so we can install it into the lower bearing of your transmission case. **Note: Make sure that you install the diff bolt head so that it will end up on the same right (passenger) side of the transmission where the drive shaft is. If you install the diff backwards so that it is on the left or driver's side you may have a problem with the diff backing off (loosening up).** (3) Now we can install the #6570 idler gear (that was also in bag D) into the transmission case. (4) Fig. 65 shows all three gears installed into the right case half with the left case half ready to install over the gears.

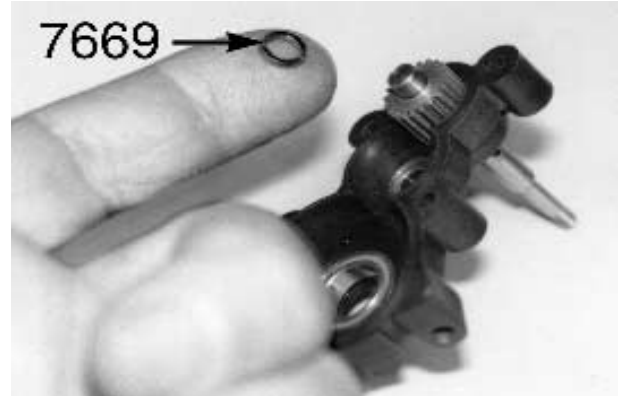

Fig. 63



Fig. 64



Fig. 65

□ **Fig. 66** Open bag F and remove the three #6928 4-40 x 1.0" SHCScrews and one #6925 4-40 x 1/2" SHCScrew. Fit the two transmission housing halves together and thread the three #6928 SHCScrews into the upper three holes in the

housing, from the left hand side, as shown. Now thread the #6925 SHCScrew into the bottom front hole of the housing. This is done from the left hand side as well. **WARNING!** Make sure that the #7669 drive shaft spacer is still on the outer shaft end before closing up the transmission case halves. Failure to do so can cause transmission problems later.

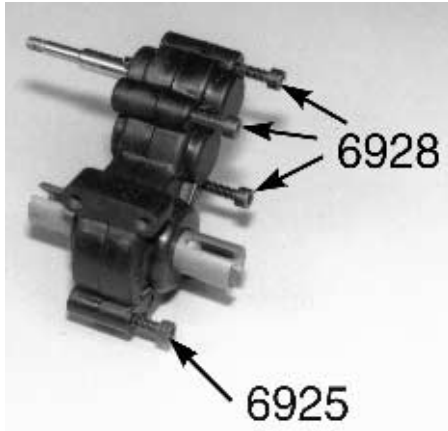
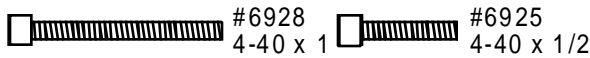

Fig. 66



□ **Fig. 67** Now we can take the three #7375 black motor plate spacers we set aside in Fig. 56. These are going to install into three cavities of the right housing half over the threaded ends of the #6928 SHCScrews as shown. They will install with the small end of the spacer first which will fit into the cavity.



Fig. 67

□ **Figs. 68 & 69** (1) Go back to your transmission bag and locate the bag containing the #7370 black aluminum motor plate. (2) We also want to find the small bag which contains the #7373 foam motor plate gasket. (3) Now peel the backing from the gasket and center it over the round hole in the motor plate. We want to install it onto the back side of the motor plate. (4) Slide the motor plate over the drive shaft (foam gasket side first). Line the threaded holes in the motor plate up with the screws coming out of the motor plate spacers. Thread the screws into the motor plate until the plate is secured to the spacers. Just snug the screws down, do not try to over tighten them. Make sure your motor plate is installed with the motor guard tabs on the transmission case side as shown in fig. 69

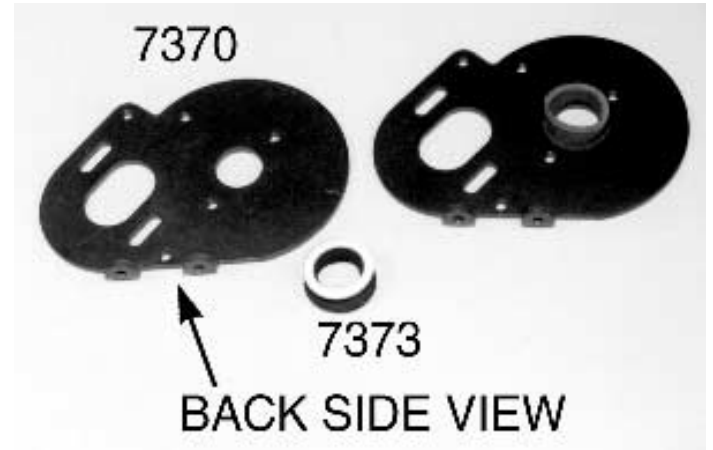

Fig. 68



Fig. 69

□ **Figs. 70 & 71** (1) In the same motor plate bag you will find the #7371 black aluminum motor guard. (2) Now go back to bag F and take out two #6288 4-40 x 1/4" BHSScrews. Now you are going to fasten the motor guard to the motor plate with the #6288 screws. The motor guard fits over the mounting points on the motor plate. See fig. 71.

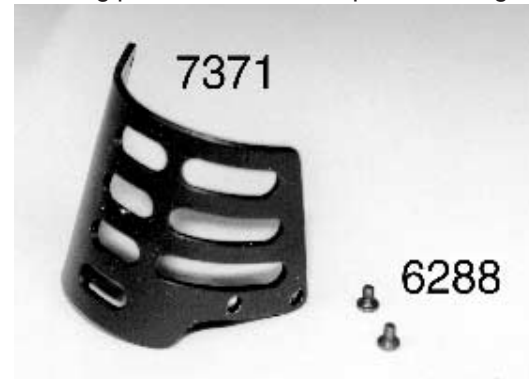

Fig. 70

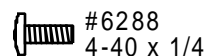



Fig. 71

□ **Figs. 72 & 73** Now we are going to start assembling the Associated Torque Control clutch assembly. From bag E remove the #6583 inner torque clutch hub. On the back of the hub you will find a slot which will fit over the #6572 roll pin of the drive gear/shaft assembly. Install the hub onto the shaft slotted end first making sure that the slot fits down over the roll pin.



Fig. 72



Fig. 73

□ **Figs. 74, 75 & 76** Bag E also contains the #6584 Associated outer torque control clutch hub and the #6585 Rulon clutch disc. Remove these from the bag. Fig. 74 shows both sides of the #6584 outer torque clutch hub along with the

#6585 Rulon clutch disc. It also shows the two parts assembled.

Now it is time to complete the assembly of the torque clutch. In bag B you will find the #6596 3/16" x 5/16" unflanged bushing. Remember all versions of the truck use this bushing in the torque clutch. In bag E you will find the #6594 thrust bushing and two #6594 steel thrust washers, as well as the #6587 torque control spring and the #6629 5-40 gold colored locknut. Fig. 75 has all the parts laid out in the order they will go onto the drive gear/shaft.

(1) Install the #6596 bushing inside the hole on the outside of the #6584 outer clutch hub. (2) Now we need to install the clutch hub, Rulon disc, and bushing onto the drive shaft. Make sure that the bushing goes onto the large portion of the drive shaft and that the clutch disc stays centered on the hub. (3) Next we will install one of the #6594 hardened steel thrust washers (shiny finish). When this is installed correctly it will be inside the hub so that the outer face will be almost flush with the top edge of the #6584 outer clutch hub. (4) The next item installed will be the #6594 thrust bushing that looks like a thick gold washer. **Note:** If the thrust washer does not slide easily onto the shaft just after the threads you will need to remove the thrust washer and deburr the inside edges of the center hole with an X-acto® knife. (5) Now install the second #6594 hardened steel thrust washer (shiny finish). **WARNING!** Do not get the special hardened steel thrust washers, from bag E, mixed up with the #6936 aluminum washers in the kit. Using any other washers from the kit could damage the torque clutch assembly. (6) After the second washer you will install the #6587 torque control spring (7) followed by its #6629 5-40 gold colored locknut. Tighten the nut so that one full thread is showing outside the locknut. This will be a good starting point for breaking in your torque clutch. Fig. 76 shows all the parts installed. We will discuss fine tuning the adjustments on your transmission later.



Fig. 74

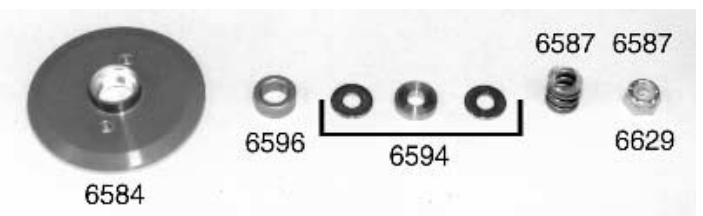

Fig. 75

- ⊙ #6594 washer
- ⊙ #6594 bushing
- ⊙ #6629 5-40 locknut
- ⊙ #6596 3/16 x 5/16 unflanged bushing



Fig. 76

□ **Figs. 77 & 78** Open bag #7-15 and remove the #6695 87 tooth 48 pitch Stealth spur gear. From bag F remove two #6568 4-40 x 3/16" BHCScrews. Mount the spur gear with the back side (which has a raised circle about the diameter of a quarter in the center) towards the torque clutch assembly. (This is the side without the molded spur gear number.) Line up the two hub mounting holes with the gear mounting holes and install the 3/16" BHCScrews. **Note:** Do your best to press on the spur gear evenly and then try and tighten the mounting screws evenly. This will help to prevent any warping of the spur gear causing gear meshing problems.

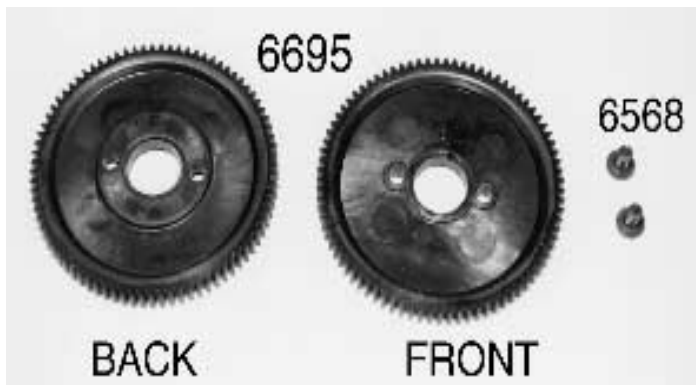

Fig. 77

□ #6568
4-40 x 3/16



Fig. 78

□ **Fig. 79** Back in fig. 46 we set aside the #6575 nylon diff thrust bolt cover (looks like a thin version of the #6575 T-nut without the steel insert). We are now going to install this into the right (passenger side) diff outdrive. This is used to cover the head of the diff bolt and to help keep dirt out of the thrust bearing assembly. It still allows you to check your diff adjustment without taking the cover out each time.

Final transmission adjustments and maintenance are discussed in the tuning section at the end of the manual

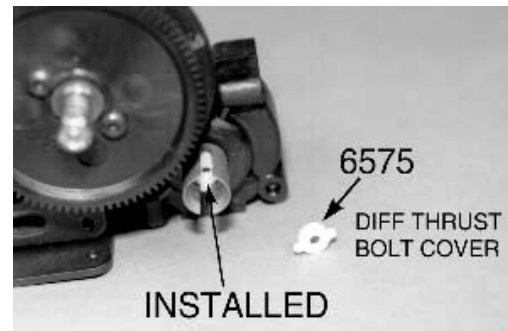

Fig. 79

REAR END ASSEMBLY

□ **Figs. 80 & 81** In bag #7-4 you will find the new #7322 black nylon rear bulkhead (fig. 80). From bag #6-14 you will need to remove two #6273 long ball ends and two #6272 ball end dust covers. To install the ball ends properly, look at the labels identifying the front and back side of the rear bulkhead in figs. 80 and 81. As you look at the bulkhead you will see that two of the holes near the center are countersunk on one side. Between them you will find a small rectangular hole. This is the front of the rear bulkhead, now turn the bulkhead over so we can install the ball ends on the back side. To the outside of each of the center holes you will find two more holes on each side. We will install the ball ends into the outermost holes. After you have threaded in the ball ends you can install one of the #6272 dust covers over each ball end.



Fig. 80

□ #6273
4-40

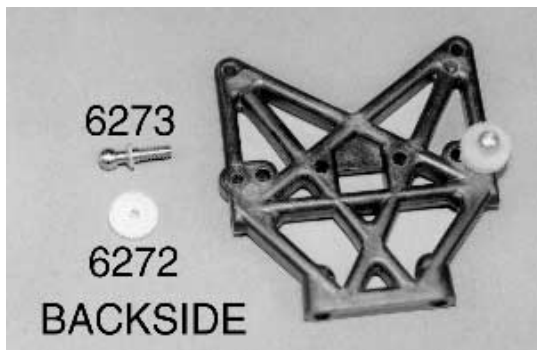



Fig. 81

□ **Figs. 82, 83 & 84** (1) In bag #7-4 you will find the #7352 black fiberglass rear shock strut. (2) Now go back to bag #7-5 and remove the two #7323 rear body mounts and two #7323 rear body mount posts, two #6285 4-40 x 1/4" SHScrews, and two #6924 4-40 x 3/8" SHCScrews. (3) Trim the four #7323 body mount parts from the mold runner if they are still attached. (4) Use the #6285 screws to mount the small round rear body mount posts to the rear body mounts as shown in fig. 83. (You can use one of the #6332 body hood pins from bag #7-5 to hold the round post while you tighten the mounting screw.) There are not a lot of threads, so be careful not to overtighten. (5) Do the same for the second mount. The body pin holes should point to the left and right when mounted on the truck. (6) On each side of the #7352 rear shock strut (near the middle) you will see three vertical holes (see fig. 82). Place the body mounts on the strut so that the small locator pin on the mount fits into the bottom hole of the shock strut and the body mount is facing up. This side will now be the back of the shock strut. Thread the #6924 screws through the center holes from the front side as shown in fig. 84. Go ahead and attach the second mount on the other side of the shock strut.



Fig. 82

 #6285
 4-40 x 1/4
 steel

 #6924
 4-40 x 3/8

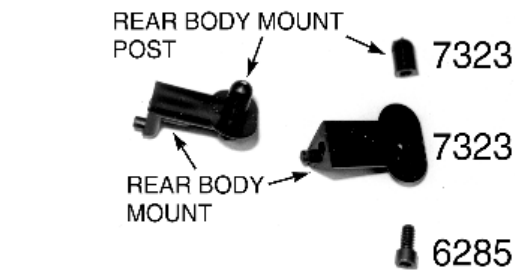

Fig. 83

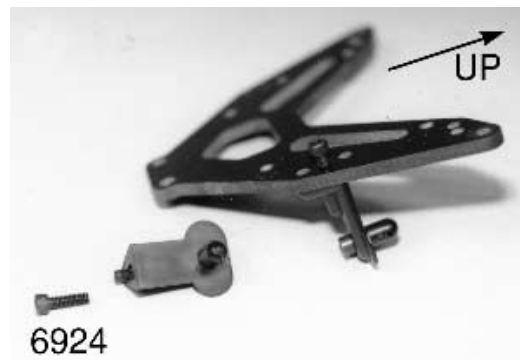

Fig. 84

□ **Figs. 85 & 86** From bag #7-4 remove two #6917 4-40 x 3/8" BHSScrews. We want to mount the #7352 rear shock strut to the back of the #7322 rear bulkhead. If you look at fig. 85 you will see two holes at the bottom of the shock strut and near the middle of the rear bulkhead. You will also see two more mounting holes at the top of the "V" shaped end of the rear bulkhead but two just inside and under the rear body mounts on the rear shock strut. Place the shock strut over the rear bulkhead so the four holes indicated on the strut line up with the four mounting holes on the rear bulkhead. Fasten the black fiberglass shock strut to the rear bulkhead as shown in fig. 86, using the two #6917 BHSScrews through the upper mounting holes. These are the ones just below the rear body mounts.

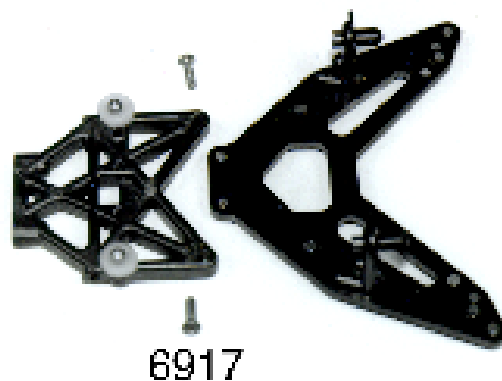

Fig. 85



Fig. 86

 #6917
4-40 x 3/8

□ **Fig. 87** From bag #7-4 remove the two #6923 4-40 x 3/4" FHSScrews. We now need to line up the bulkhead and shock strut assembly with the front of the new transmission. Make sure that the two center countersunk holes of the rear bulkhead are facing away from the transmission and that the body mounts and ball ends are on the same side as the transmission. Now fasten the bulkhead and shock strut to the transmission using the two #6923 FHSScrews. You have completed your modular rear assembly.

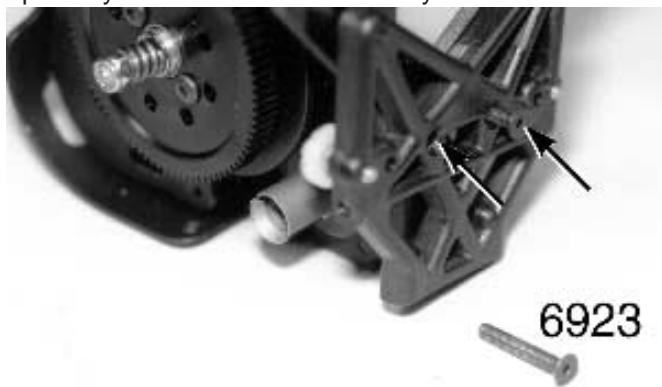

 #6923
4-40 x 3/4

Fig. 87

□ **Figs. 88 & 89** Now open bag #7-7. Inside you will find the two #7329 battery foam pads (same part number for both pads). Remove the smaller bulkhead foam pad (see fig. 88). We will use the larger foam battery pad later in the manual. Peel off the backing from the adhesive side then secure the adhesive pad side over the front of the rear bulkhead as shown in fig. 89.

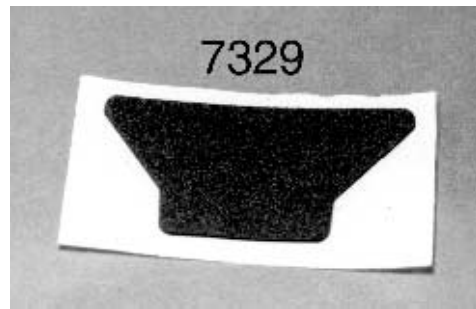

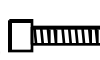

Fig. 88



Fig. 89

□ **Figs. 90, 91, & 92** Now we can secure the rear end assembly to the chassis. From bag #7-4 remove two #6292 4-40 x 3/8" FHSScrews and two #6924 4-40 x 3/8" SHCScrews. Look at the bottom of the transmission case. You will see that there is a raised square molded into the bottom of the case. Now look at the chassis and you will see that there is a matching square hole at the back that matches the one on the transmission. Place the transmission and bulkhead assembly on top of the rear of the chassis. Line up the square on the bottom of the transmission case with the square hole in the chassis. The bulkhead will be to the front and the motor guard will be the back of the chassis. This will place the rear bulkhead between the two tabs on the raised sides of the chassis. Take the two #6924 SHScrews and secure the rear bulkhead to the sides of the chassis as shown in fig. 91. Do not tighten the screws all the way just yet. Now turn the chassis upside down and secure the bottom of the chassis to the rear bulkhead using the #6292 FHSScrews as shown in fig. 92. Again leave these loose for now. We have now secured the rear bulkhead to the chassis.

 #6292 4-40 x 3/8  #6924 4-40 x 3/8

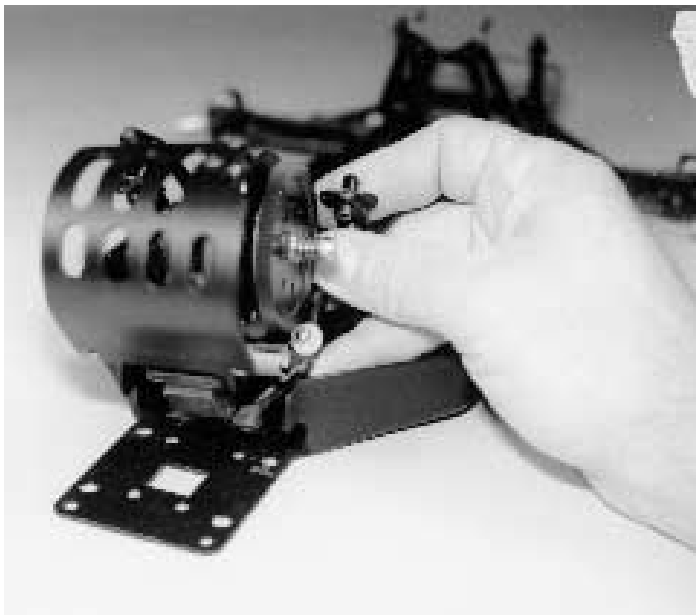

Fig. 90

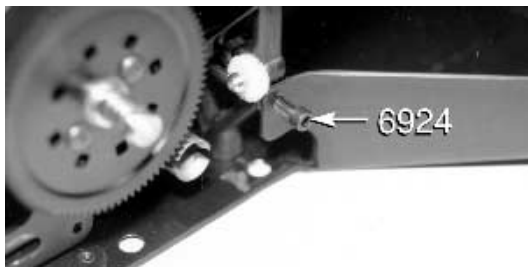

Fig. 91

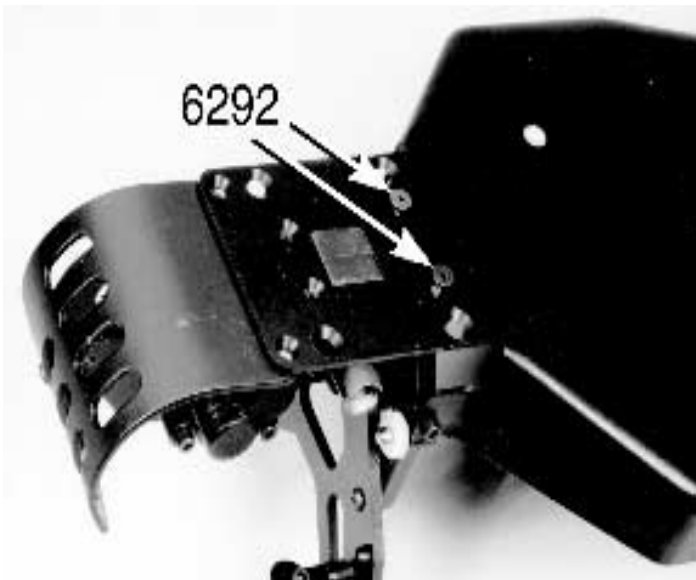

Fig. 92

□ **Fig. 93** Now go to bag F of the Stealth transmission. Inside you will find two #6292 4-40 x 3/8" FHSScrews and two #6291 4-40 x 1/4" FHSScrews. Use the two #6292 FHSScrews to bolt the transmission to the chassis using the holes shown. Make sure not to tighten these screws just yet. Now use the #6291 FHSScrews to fasten the rear motor guard to the chassis as shown. Go ahead and tighten all four screws. Now

that we have the transmission and motor guard secured we can now go back and tighten all of the screws in figs. 91 & 92.



Fig. 93

#6292 4-40 x 3/8" #6291 4-40 x 1/4"

□ **Figs. 94, 95, 96 & 97** Go back to the suspension arm bag and remove the #7354 rear suspension arms. Fig. 94 shows you which arm is left and right and where to remove the arms from the part mold runners. Fig. 95 shows you which side is top and bottom. **WARNING!! It is very important that you make sure you can tell the difference between the top and bottom sides of the rear suspension arms. If the arms are installed upside down the axles will rub on the arms, causing wear and possible damage. The bottom side of the suspension arm will be the same height all the way across. the cross "X" portion on the top side will be slightly recessed.**

Now open bag #7-8 and remove the two #7657 rear arm shock mounts and four #6925 4-40 x 1/2" SHCScrews. Referring to fig. 97, secure the rear arm shock mounts to the arms using the #6925 screws as shown. Make sure the angled side of the mount is towards the inside of the arm and angling out.

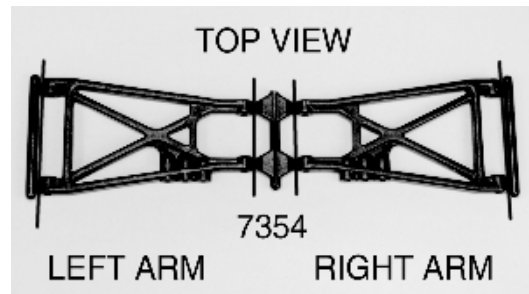

Fig. 94

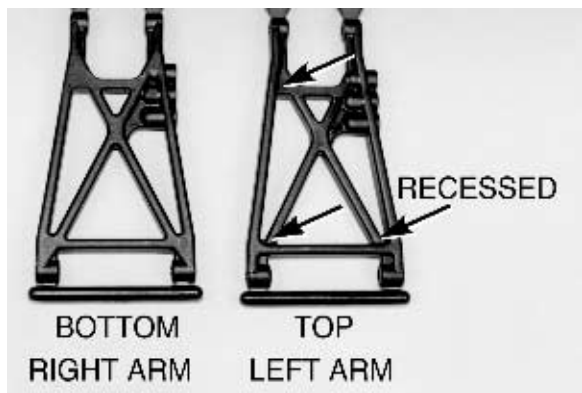

Fig. 95

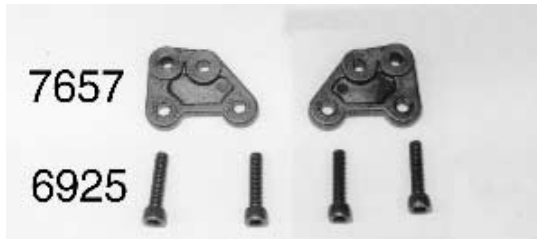

Fig. 96



Fig. 97

□ **Figs. 98 & 99** (1) In bag #7-8 you will find the #7363 3° rear suspension mounts. The mounts are normally connected together. If you look at the bottom of the mounts you will see that one is marked with an "R" for the right side and the other is marked with an "L". On top of both of them will be molded a "3", which tells you the number of degrees of rear toe-in on each mount has. (2) In the same bag you will find two #7356 rear inner hinge pins and four #6299 1/8" E-clips. (3) We will first need to check the pin fit in the rear suspension arms. Take one of the #7356 hinge pins and slide it through the arm holes. Check to make sure that the arm can swing freely on the pin on both ends of both rear suspension arms.

(4) Starting with the left rear mount and suspension arm (fig. 94 will remind you which is the left suspension arm), align the pin hole in the left rear mount with the inner pin holes of the left rear suspension arm. This will place the shock mount on the same side as the square end of the rear suspension mount. (5) Now slide the rear inner hinge pin

through the arm and the mount (6) and then install an E-clip on each end of the pin. Remember, we want the pin to be tight in the mount but free on the arm. Refer to fig. 99 for assembly detail. Now go ahead and assemble the right suspension arm and mount.



Fig. 98

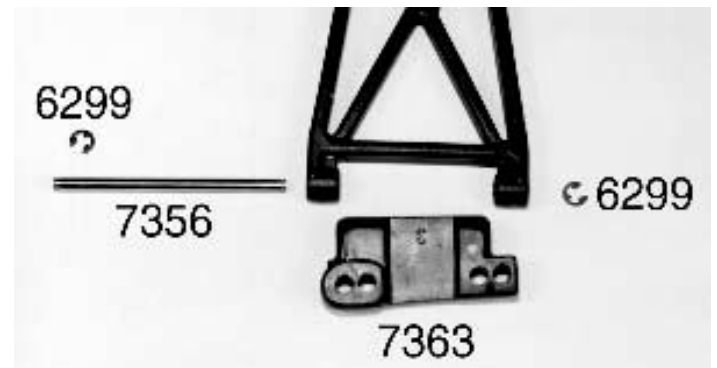

Fig. 99

□ **Figs. 100-102** The following assembly will vary depending upon which version of the T2 that you have purchased. Go back to bag #7-8 and remove the #7365 0° rear hub carriers.

If you have a ball bearing T2 you will also remove two #7377 aluminum rear axle bearing spacers, two #7367 new universal dogbone rear axles, twelve #7368 3/16" rear axle shims (14 in the bag), two #7369 1/16" rear axle spring pins, and the small bag containing the four #6906 3/16" x 3/8" unflanged ball bearings. See bottom of fig. 100.

If you have a bushing T2 you will need to remove two #6374 rear stub axles, two #6375 3/32" roll pins, two #6388 axle cone washers, and the small bag containing the four #7360 1/4" x 3/8" unflanged bushings. See top of fig. 101.

BALL BEARING KIT: (1) Slide one of the #7368 rear axle shims onto the axle, (2) followed by one of the #6906 ball bearings, (3) and this will be followed by one of the #7377 bearing spacers. (4) From the back side install the assembled #7367 universal axle into the #7365 rear hub carrier. Use the axle to seat the bearing into the back side of the rear hub carrier. (5) Now install a second #6906 bearing over the axle into the front side of the hub carrier (bottom of fig. 101). Be careful to seat it correctly without damaging the bearing race dust shield. (6) Take five of the #7368 shims and slide them onto the axle up against the outer bearing. (7) Use your needlenose pliers to install the #7369 1/16" rear axle spring pin (see fig. 102). Make sure that you center the spring pin to the best of your ability. This will prevent any problems when installing the rear wheel later in the manual. (8) Go ahead and repeat the above steps for the second axle. They both go together the same way.

BUSHING KIT: (1) Slide one of the #7360 bushings onto the #6374 rear stub axle. (2) Now slide the rear stub axle and bushing into the back side of the #7365 rear hub carrier. (3) Next install the second #7360 bushing over the axle and push it into the front of the hub carrier. (4) This will be followed by the #6388 cone washer. We want to install the cone washer so that the raised outer edge of the washer is facing away from the bushing. (5) Now you will need to take your needlenose pliers and install the #6375 roll pin into the hole drilled in the rear stub axle (see fig. 102). *Racer's Tip: You can use your needlenose pliers to gently close the split on one end of the roll pin. This slightly smaller end will then be easier to get started into the roll pin hole.* Make sure you do your best to center the roll pin in the hole. This will prevent any problems when installing the rear wheels later in the manual. Go ahead and assemble the second axle the same way.

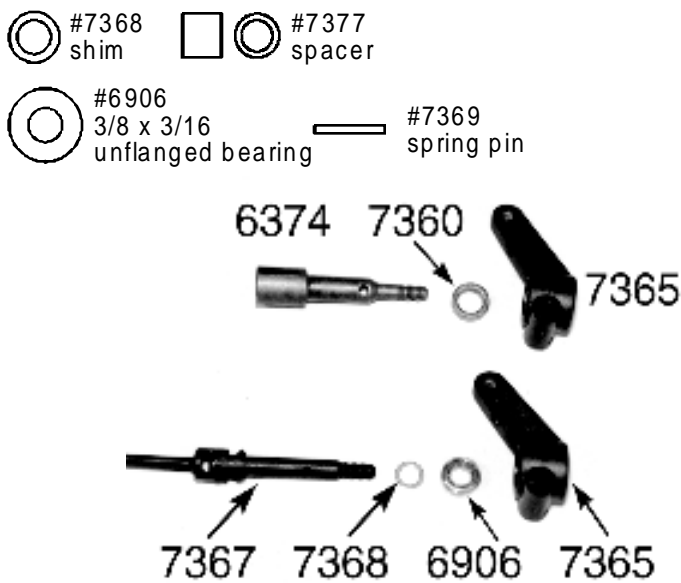

Fig. 100

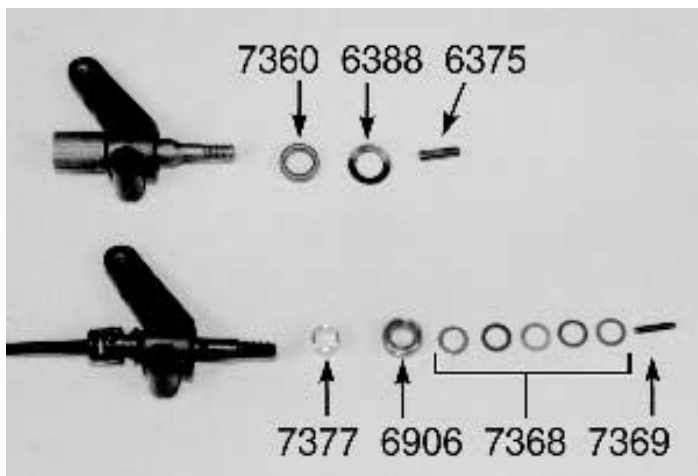

Fig. 101

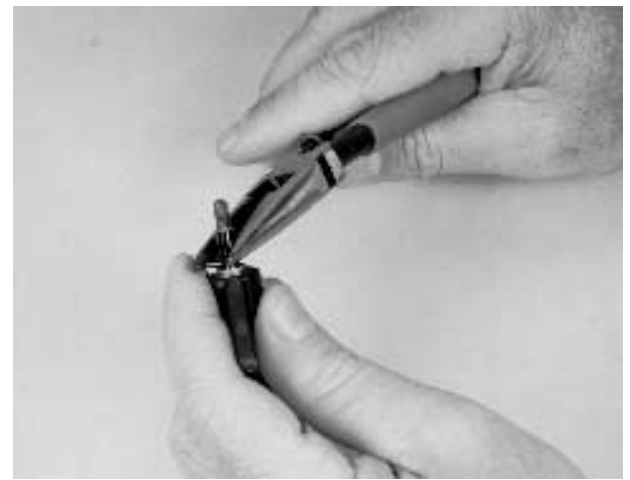

Fig. 102

□ **Fig. 103** From bag #6-14 remove two #6273 long ball ends, two #7260 4-40 small plain nuts and two #6272 ball end dust covers. Install one of the ball ends on each of the two hub carriers. Make sure that each ball end is on the opposite side of the hub carrier as shown in fig. 103. Now go ahead and install the plain nuts onto the threaded end of each ball end. Go ahead and install the #6272 ball end dust covers as shown. The photos show the universal axles. The only part that will look different will be the stub axle for the bushing kit. Once the ball ends have been installed the hub carriers now have a right and left side as marked.

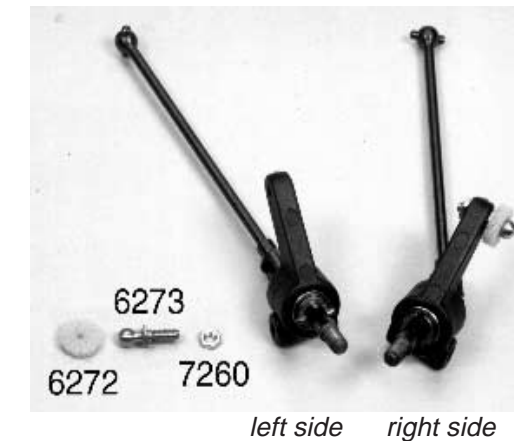
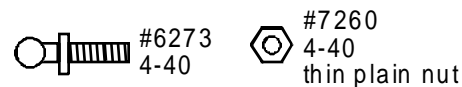

Fig. 103



□ **Figs. 104 & 105** This assembly will be the same for all versions even though the axle will look different. (1) Remove two #6381 truck rear outer hinge pins, two #6466 1/8" (.125") nylon spacers, and four #6299 1/8" E-clips from bag #7-8. **Note:** Replacement part #6466 contains .031", .062" and .125" nylon spacers. (2) Starting with your left rear suspension arm place the left rear hub carrier and axle assembly between the outer arm mounting ears. **Note:** To make sure you have the correct hub carrier the ball end will be on the same side of the arm as the #7657 rear shock mount. (3) There will be a gap between the hub carrier and the suspension arm, which will be taken up by the #6466 nylon

spacer. Line up the pin holes in the arm and hub carrier. (4) Install the outer hinge pin through the forward pin hole of the A-arm then through the hub carrier. (5) Now place the nylon spacer between the hub carrier and the rear arm pin hole and push the pin through the spacer and rear arm pin hole. (6) Install one E-clip on each end of the hinge pin. Your completed rear arm assembly will look like fig. 105. (7) Now go back and repeat the steps to assemble the right suspension arm and hub carrier, making sure that the spacer is on the rear side of the hub carrier just like the left arm assembly. **Racer's Tip: The 1/8" spacer will allow you to change the length of the truck's wheelbase for different handling characteristics or track conditions, by moving it in front or behind the rear hub carrier. The rear arm mount is no longer position adjustable on the T2.**

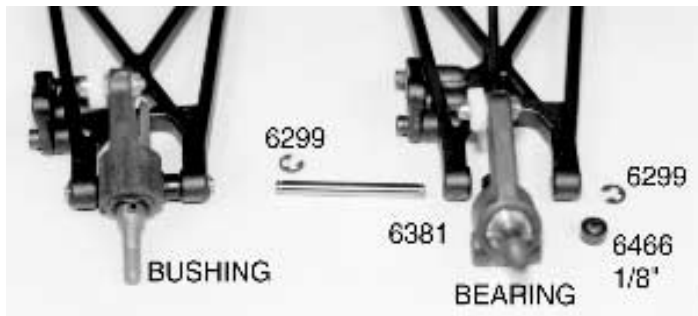
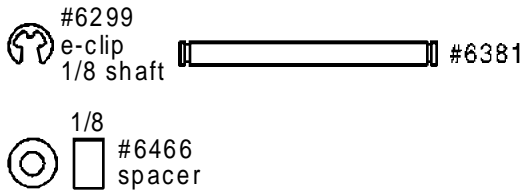

Fig. 104

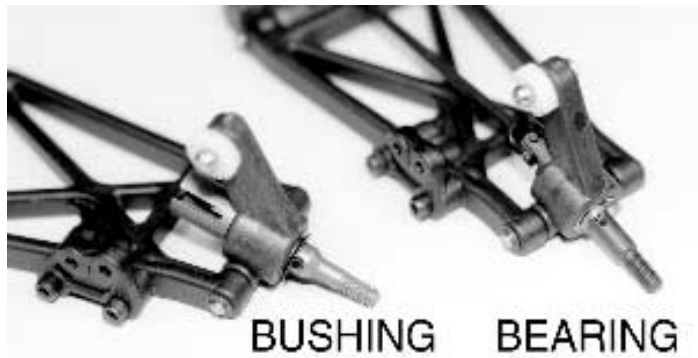

Fig. 105

□ **Figs. 106** This step will also be the same for all models. (1) Take four #6280 8-32 x 1/2" FHMScrews from bag #7-8. We will start with the left suspension arm assembly and line up the rear suspension mount over the two mounting holes on the left side of the chassis. The only holes on the mount that will line up with be the forward and the rear hole. On this truck the inside holes cannot be used. Thread the two screws into the mount from the bottom of the chassis. Now go ahead and do the same for the right side arm assembly. Remember the shock mounts will be on the front side.

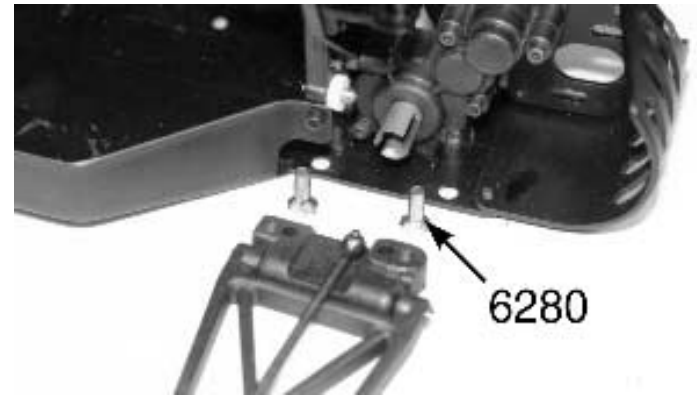

Fig. 106

□ **Fig. 107** Remove four #6274 ball cups from bag #6-14 and two #7253 truck turnbuckles from bag #7-8. Thread the ball cups onto the turnbuckles evenly and adjust the length to 3 3/64" (3.05" or 77.45mm) center to center of the ball cup sockets. Then compare them to the scale drawing shown at the bottom of the photo. On these two turnbuckles the ball cups will face opposite directions. Just as on the other turnbuckles, one end of the turnbuckle has right hand threads and the other end has left hand threads. Remember the photos are not to scale.

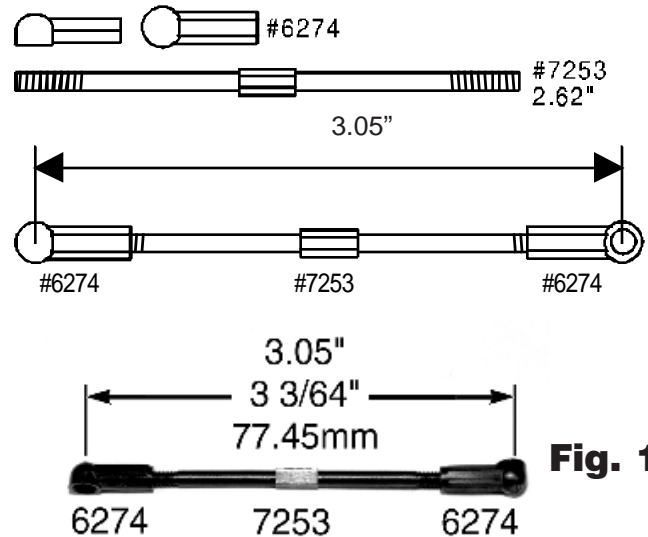

Fig. 107

□ **Figs. 108, 109 & 110** FOR BUSHING KITS we need to remove two #6372 1/16" thick plastic dog bone spacers and two #6372 dog bone springs along with two #7361 truck dog bones. These will all be in bag #7-8.

(1) Look at fig. 108, we are going to install one #6372 plastic dog bone spacer into each of the two slotted outdrives of the transmission. (2) Next we are also going to install a #6372 dog bone spring into the slotted end of each of the two #6374 rear stub axles. There is a hole drilled into the axle that the spring fits down into. (3) Take one of the #7361 truck dog bones and line it up with the slotted outdrive of the transmission. Go ahead and slide the dog bone pin into the slots. (4) Now rotate the rear stub axle until you can line up the outside

end dog bone pin with the slots in the stub axle. When installed everything should look like the top part of fig. 110.

(5) Go ahead and install the parts on the opposite side.

FOR BALL BEARING KITS we do not need any extra parts. Rotate the universal axle until the dog bone pin on the inside end lines up with the slots in the outdrive. Rotate the hub carrier until the pin slides into the slot. Look at fig. 109 for detail. Go ahead and do the same for the axle on the other side.

(6) Now that all the parts are ready we can now snap on the two #7253 rear tie-rod turnbuckles. Starting on the left side, snap one end of the turnbuckle onto the ball end mounted on the left side of the rear bulkhead. (7) Making sure the axle parts are still in the slots, snap the outer end of the turnbuckle onto the ball end on the left hub carrier. (8) Fig. 110 shows the left side correctly installed. You will most likely need to use pliers to snap on the ball cups. Now install the other turnbuckle on the right hand side still making sure the axle parts are in place.

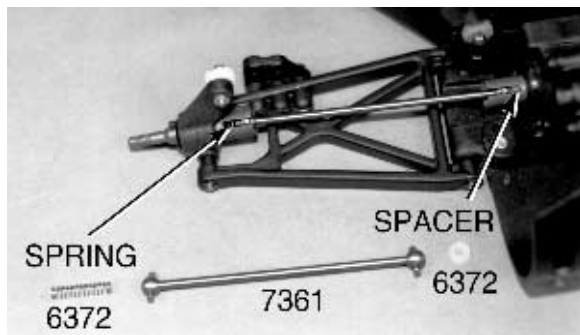

Fig. 108



Fig. 109

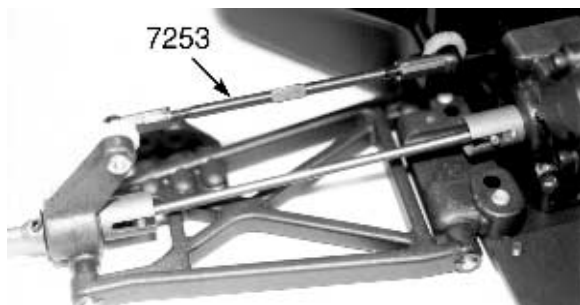

Fig. 110

NEW SHOCK ASSEMBLY

Your T2 kit has our internal seal shocks which we have been racing with since their release in 1990. Over the years we have made several major improvements to these shocks. This includes the addition of new molded PTFE shock pistons and new molded internal shock seal assembly parts. **PLEASE FOLLOW THE NEW ASSEMBLY INSTRUCTIONS CAREFULLY!**

□ **Fig. 111** In the kit bag you will find the new master shock bag which contains bags #7-9, #7-10, the shock piston bag, and the shock assembly parts bag. We have found it easier to assemble all four shocks at the same time. (1) Open bag #7-9 and remove the two #6458 rear shock shafts. (2) Now open bag #7-10 and remove the two #6459 front shock shafts. (3) Next open the shock assembly parts bag. Inside you will find the small roll of #6299 1/8" E-clips (remember you will still be looking for the white tape not the E-clips). Install one E-clip on each shock shaft in the lower groove (closest to the threaded end as shown in fig. 111). If you have run out of E-clips you should have extras in bags #7-1 or #7-8.

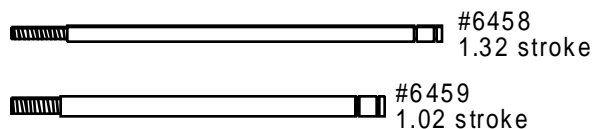

Fig. 111



□ **Figs. 112 & 113** In a separate bag inside the large shock bag you will find the #6465 new PTFE shock piston set. You will find four each of #1, #2, and #3 shock pistons on this piston parts tree. The #1 piston is the lightest damping and the #3 piston is the heaviest damping. On one side of each piston you will find the numbers molded in.

The new pistons are molded to help eliminate the possibility of burrs on the piston edge which will interfere with smooth shock action within the shock body. To properly remove the shock pistons from the tree twist the piston up as shown in fig. 113. Twisting down will leave an edge on the piston which could reduce performance of the shock. For the truck you will need to remove two #2 pistons and two #3 pistons from the parts tree. If there are any remaining burrs **carefully** remove them with a sharp hobby or X-acto® knife.

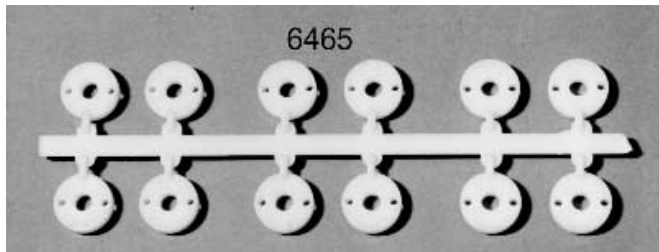

Fig. 112

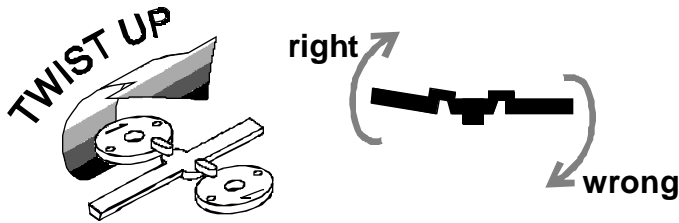

Fig. 113

□ **Figs. 114 & 115** We are going to install the two #6465 (#2) shock pistons on the two #6458 rear shock shafts (the longer shafts). Secure each piston to the shaft with a #6299 E-clip. Now we need to install the two #6465 (#3) shock pistons onto the shorter front shock shafts and secure them with an E-clip. Fig. 115 shows one shock shaft with piston installed. **Racers Tip:** It does not matter which way you install the pistons, but we recommend having the number up so you can see what piston you are using when you are servicing your shocks.

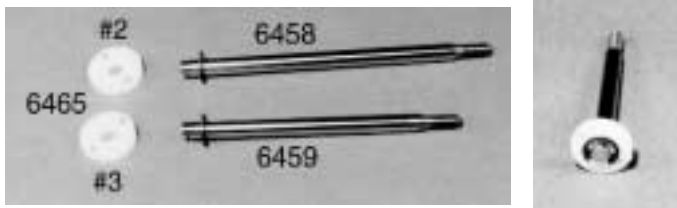

Fig. 114 Fig 115

□ **Figs. 116, 117 & 118** From the shock assembly parts bag remove the #5407 red rings and the new #6440 molded PTFE shock assembly parts. This molded parts tree contains only enough plastic parts to assembly four shocks, so take your time and don't damage or lose any. **Note:** Part number #6440 is also a complete replacement set of O-rings and plastic assembly parts to rebuild four shocks. Fig. 116 gives the part names, as used in the instructions, for each plastic part on the parts tree.

WARNING! Because of the precision tolerances of these new parts, correct removal of the parts from the parts tree is CRITICAL! Using an X-acto® knife with a very sharp blade, carefully trim each part from the parts tree. IT IS EXTREMELY IMPORTANT THAT NO PART OF THE TWO MOLDING RUNNERS REMAIN. IF YOU ARE UNCERTAIN, IT IS SAFER TO REMOVE A TINY AMOUNT OF THE PART WHERE THE MOLD RUNNER WAS ATTACHED. This applies to both the small nylon washers

and the large nylon spacers. Any part of the mold runner remaining will prevent the parts from snapping in correctly. This will cause leaking around the shock shaft, can cause binding of the shock shaft, and reduce the shocks performance. Use your finger on the edge of the parts to feel for burrs that you cannot see and carefully remove them.

Fig. 117 shows a close up view of two small nylon washers used with the red O-rings. The washer on the left still has two small burrs on it while the one on the right side of the photo has had all the burrs removed. The arrow in the photo points to one burr and the second burr is directly opposite on the other side of the same washer.

From the master shock bag remove the #6429 shock assembly tool. Stand the assembly tool on end with the small tip up.

To correctly assemble each shock, install the parts on the shock assembly tool in this order: (1) first the split locking washer, (2) then one small nylon washer, (3) red O-ring, (4) large nylon spacer, (5) second red O-ring, (6) and second small nylon washer. You can compare this sequence with layout in fig. 118. Fig. 122 shows a cutaway drawing of the shock body with the internal seal parts installed. **Note:** if you need to replace just a red O-ring, you can purchase them separately under part numbers #5407 (8 red O-rings).

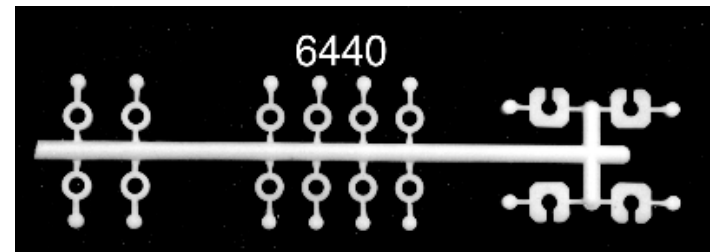

Fig. 116

Left: 4 large nylon spacers
Center: 8 small nylon washers
Far right: 4 split washers

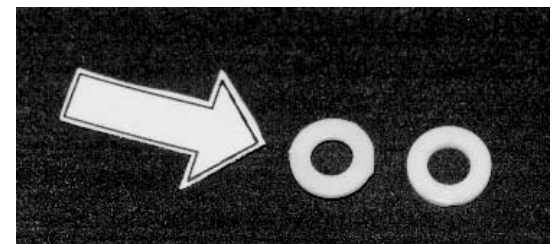
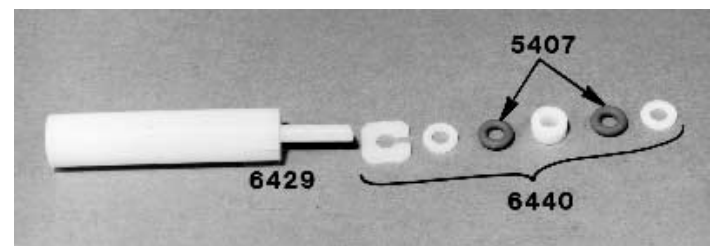

Fig. 117



⊙ #5407
red O-ring

Fig. 118

□ **Figs. 119, 120 & 121** (1) Open bag #7-11 and remove the bottle of 25 weight silicone shock oil (fig. 119). This is the recommended starting shock oil weight for this truck with the recommended pistons. When you run out of the shock oil that we supplied with the kit, the part number for a 2 ounce replacement bottle is #5428.

(2) Go back to bag #7-9. If you have a bushing kit you will remove two #6424 1.32" stroke gold anodized shock bodies. For the ball bearing kits remove the two #6435 1.32" stroke hard anodized/PTFE sealed rear shock bodies. (3) Now go to bag #7-10. The bushing kits will have two #6425 1.02" stroke gold anodized shock bodies inside. The ball bearing kits will have two #6436 1.02" stroke hard anodized/PTFE sealed shock bodies.

(4) Put a couple of drops of the silicone shock oil into each shock body just before you install the seal parts. The oil helps coat the inside of the seal cavity inside the shock body. This helps prevent damage to the O-rings as they are being inserted.

(5) Fig. 120 shows the shock body along with the shock seal parts on the installation tool. We are now ready to install the seal part inside the shock body. (6) Place one or two drops of oil on the seal parts. We can now insert the seal parts into the shock body. (7) Pick up the shock body and line it up with the shock tool (fig. 120). Slowly insert the tool into the shock body, rotating the shock body as you are installing the seal parts into the seal cavity. This makes it harder for the O-rings to cut or tear on the edge of the cavity during the assembly. (8) As you reach the bottom of the shock body you will need to line up the seal parts with the cavity that they go into. If everything goes in properly, the bottom edge of the beveled tip on the assembly tool will be almost flush with the bottom of the shock body as shown on the right side of fig. 121.

(9) Now stand the shock tool on your work bench with the shock body on top. Push down firmly on the shock body. We want to hear and feel the split washer snap into its groove. The split washer is made of a hard material, so it might take quite a bit of pressure before it will snap into place. The end of the tool will be sticking out at least 1/8" when properly installed. This is shown on the left side of the photo for fig. 121. (10) The tool should slide out easily. If it does not, then you may not have the parts snapped in correctly, or there are still burrs on either the small nylon washers or the large nylon spacer. (11) Now carefully look inside the shock body for any obvious signs that indicate the parts did not go together correctly. (12) Next you can go back and repeat the process to assemble the other three shocks.



Fig. 119



Fig. 121

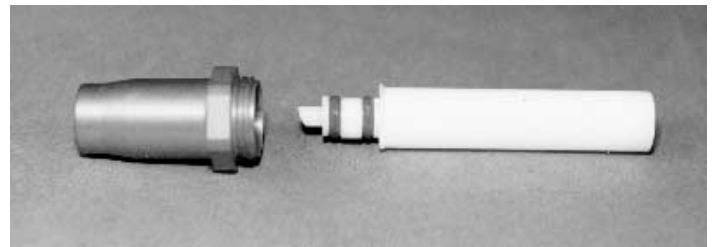

Fig. 120

□ **Figs. 122 & 123** **HOW TO DISMANTLE THE SHOCK SEAL PARTS** Fig. 122 shows a cutaway of the bottom portion of the shock showing how all of the parts fit into the shock seal cavity. Fig. 123 is the same cutaway drawing depicting the shock assembly tool removing the shock seal parts.

In order to dismantle the shock seal parts you must (1) remove the shock cap, (2) drain the shock oil, (3) and remove the shock shaft with piston. (4) Insert the small angled tip of the shock tool into the bottom of the shock, sliding the tool all the way in until the tool bottoms out against the shock body. (5) Now angle the tool slightly and slowly slide the tool down until the tip slides over underneath the split washer and first small nylon washer. Now place the pointed tip of the tool under one side of the split locking washer and push firmly up until the split washer snaps out of its groove. Then pull the tip of the tool down and use it to push the rest of the internal parts up and out of the cavity.

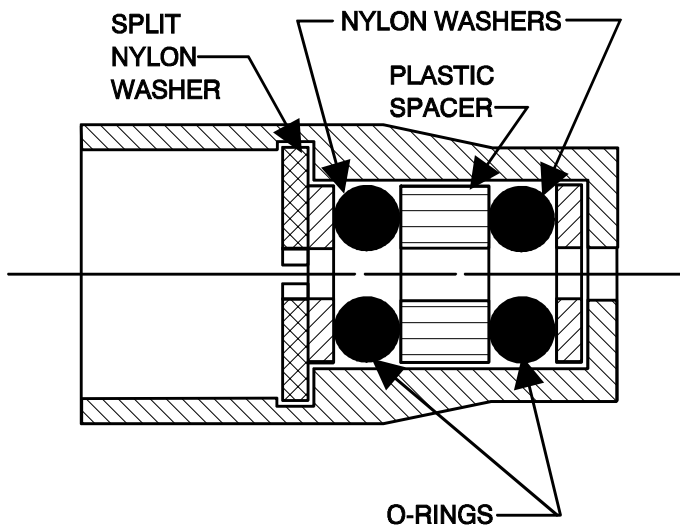

Fig. 122

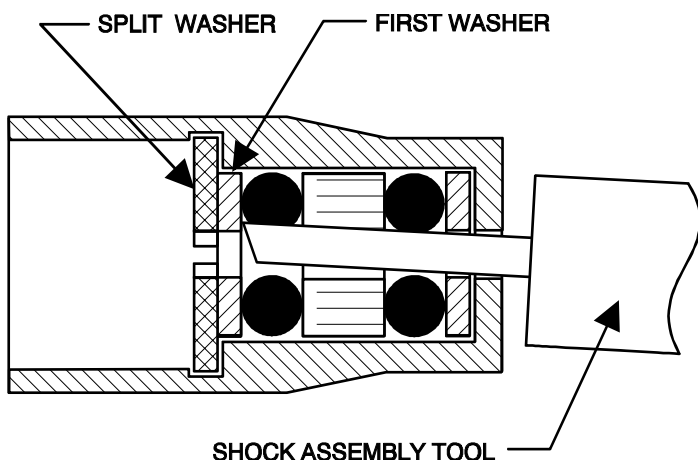

Fig. 123

Fig. 124 Now we can install the shock shafts with pistons. Make sure that we install the long shock shafts with #2 pistons into the #6435 long shock bodies, and the short shock shafts with #3 pistons in the #6436 short shock bodies. Place a couple of drops of oil on each shock shaft and slowly insert the shaft and piston into the shock body. Pull the shaft down until the piston seats against the bottom of the shock body. We want to be careful inserting the shaft, for we do not want to damage the red O-rings and cause the shock to leak.



Fig. 124

Fig. 125 Locate the four #6469 black O-rings in the shock assembly parts bag earlier. Install one on each shock body over the threads and seat it flush in the pocket at the bottom of the threads next to the hex portion of the shock body..



#6469
black O-ring

Fig. 125

Figs. 126, 127 & 128 Now we need to remove the shock caps. If you have a bushing kit you will find two #6428 black plastic shock caps in bag #7-9 and two more in bag #7-10. If you have a ball bearing kit there will be two #6439 black aluminum shock caps in bag #7-9 and two more in bag #7-10.

Now we can fill each shock with shock oil. **(1)** Take your container of silicone 25 weight shock oil and fill one shock body until it fills to within 1/16" of the top of the shock body. **(2)** Now move the shock shaft up and down several times slowly to make sure that there are no air bubbles trapped under the piston. If there were air bubbles, refill the shock until it is within 1/16" of the top. **(3)** Now push the shock shaft up into the shock body (leave the piston about 3/8" from the top on the front shocks and about 5/16" from the top on the rear shocks). **(4)** Now take your #6428 or #6439 shock cap and place a couple of drops of oil on the internal threads. Now it is safe to thread the cap onto the shock body, all the way down to the hex portion shock body. There should be no

gap between the cap and the hex portion of the shock body (see arrow in fig. 128). The O-ring will actually be doing the sealing, so we must be careful not to overtighten the cap. As soon as the cap comes in contact with the body just turn a little bit further to seat it. **WARNING!!: not oiling the threads on the plastic shock caps can cause them to seize onto the shock body. You will not be able to remove the caps when you go to service your shocks.**

(5) Now work the shock shaft up and down about five or six times, then push the shaft all the way in and let go of the shaft. We want the shaft to come back out of the shock body 1/4" on its own. If it did not, pull the shaft all the way down then unscrew the shock cap. Adjust the piston height inside the shock body before you screw the cap on again according to the following: If there was too much rebound (the shaft came out too far on its own) then bring the piston closer to the top of the shock body before you screw the cap on this time. If there was not enough rebound then you will need to leave the shock piston lower in the shock body before screwing the cap on. If you have to make adjustments always recheck the oil level before you make those adjustments. You are trying to make sure all four shocks have the same rebound.



Fig. 126



Fig. 127

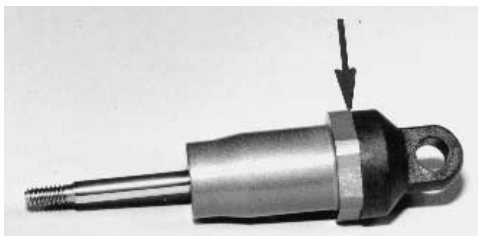

Fig. 128

□ **Figs. 129 & 130** (1) From bag #7-11 remove the two new #6474 spring clamps and cups parts trees and four #6932 4-40 x 5/16" SHCScrews. Fig. 129 shows one of the #6474 parts trees and identifies the three parts. (2) Now go

back to bags #7-9 and #7-10. Inside each bag there is a smaller hardware bag. Remove two #7217 shock rod ends and #7217 black plastic pivot ball ends (from each bag). (3) Remove the shock spring clamp, spring collar, and spring cup parts from the parts trees. (4) Slide the nylon spring clamp onto each shock. To make it easier to adjust the springs later, install the spring clamps so that the #6932 screws will be on the outside and facing forward on each shock. (5) Each spring clamp has one open hole and one closed hole for the tension screw. Install the #6932 screw through each open hole and then thread it into the closed hole. (6) Now slide the collar to the top of the shock body and tighten it just enough to keep the collar from moving.

(7) Now take one of the #7217 shock rod ends and push it into the plastic pivot ball. The easiest way to do this is to place the ball end on a table or bench, set the nylon eyelet over the ball and push down on the ball with your 1/4" nut driver. You can also use needlenose pliers to squeeze the parts together; just take your time and use the smooth part of the jaws so you do not damage the plastic ball. Go ahead and do the other three ball ends.

(8) Now thread the nylon shock rod end onto the shock shaft. To keep the shock shaft from turning, you will have to hold the shaft with your needle nose pliers. **WARNING! Make sure you only grab the shaft with the smooth part of the jaws of your needlenose pliers and as close to the threaded end as possible.** This is very important, for we do not want to scratch the shaft where it will ride in the O-rings, damaging the O-rings and causing the shock to leak. Do the same for the other three shocks.

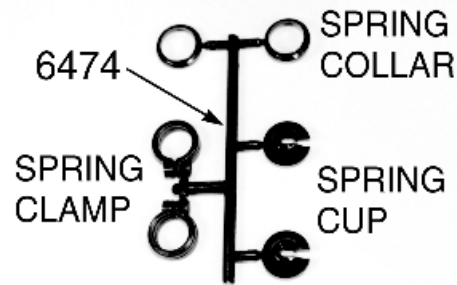
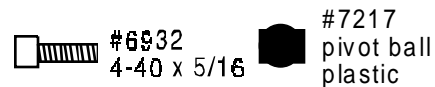

Fig. 129



Fig. 130



□ **Fig. 131** Remove the two long #6480 (2.75" length) rear green springs and two short #7427 (2.25" length) front green springs from bag #7-11. Install one #6474 spring collar onto each of the long rear green springs. Do the same for the short front green springs. Slide the long springs onto the long rear shocks. Next slide the short front springs onto the short front shocks. Make sure the shock shaft is fully extended

then compress the shock spring and slide one of the #6474 spring cups onto the shaft so that it will slip down over the #7217 black nylon shock rod end. You can then let the spring seat on the spring cup. For the rear shocks adjust your spring clamp so that there is a 3/10" (.300" or 7.6mm) gap between the hex portion of the shock body and the top of the spring clamp. For the front shocks adjust your spring clamps so that there is a spacing of 1/32" (.031" or .79mm). Tighten the collars enough so they cannot be moved but not so tight as to strip out the threads. You will need to measure these with your ruler or calipers because the photo is not to scale.

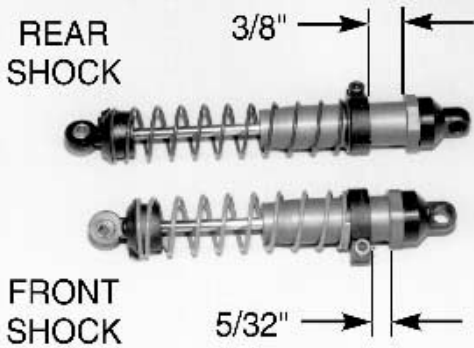

Fig. 131

□ **Figs. 132, 133 & 134** Now we are ready to start installing the shocks onto the truck. We will start with the rear shocks. (1) From bag #7-9 remove two #6927 4-40 x 3/4" SHCScrews, two #6936 #4 aluminum flat washers, and two #6295 4-40 plain nuts. (2) Screw the 3/4" SHCScrews into the top outside hole of the rear fiberglass shock strut, from the back (transmission) side as shown in fig. 132. (3) Now install one of the #4 flat washers on the front and then thread on the 4-40 plain nut. (4) Tighten the screws and nuts. (5) Now go back to bag #7-9 and remove the two #6473 nylon shock bushings. (6) Install one onto the threads of the two screws we just installed (see fig. 133). Make sure that the flange of the bushing is against the 4-40 plain nut.

(7) You will find another two #6473 nylon shock bushings in bag #7-10. Go ahead and install them onto the front shock mounting screws as shown in fig. 134. Again make sure the flange part of bushing is towards the nut.

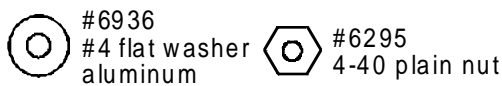

Fig. 132

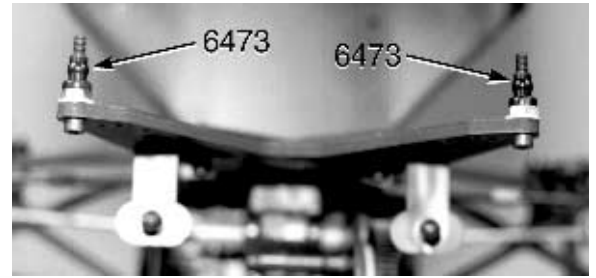

Fig. 133

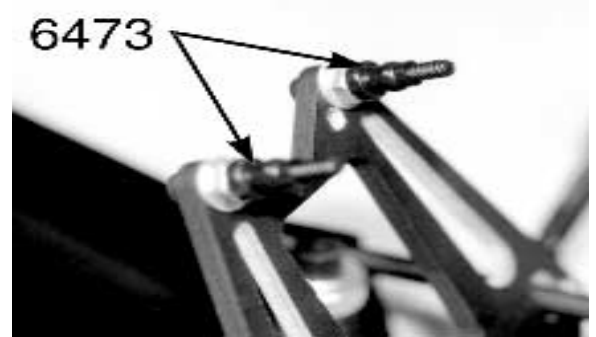
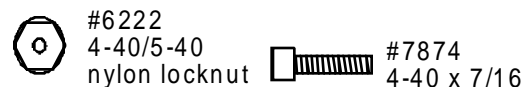

Fig. 134

□ **Fig. 135** (1) Take one of the long rear shock assemblies and slide the shock cap over the nylon shock bushing at the top of the rear shock strut. **Note:** Make sure you install the shock so you will be able to easily adjust the shock spring clamp. Loosen the screw and rotate the collar if necessary. (2) Remove the two #6222 4-40/5-40 black nylon self threading nut from bag #7-9. (3) Thread one nut onto the upper shock mounting screw to hold the rear shock in place. Only tighten the nuts just enough to make contact with the shock bushings, but not enough to cause binding.

(4) Go back to bag #7-9 and remove the two #7874 4-40 x 7/16" SHCScrews. (5) Now line up the #7217 pivot ball on the bottom of the rear shock with the outside hole on the #7657 rear shock mount as shown. (6) Fasten the pivot ball to the front of the shock mount using the #7874 SHCScrew. (7) Go ahead and install the other rear shock using the above steps.



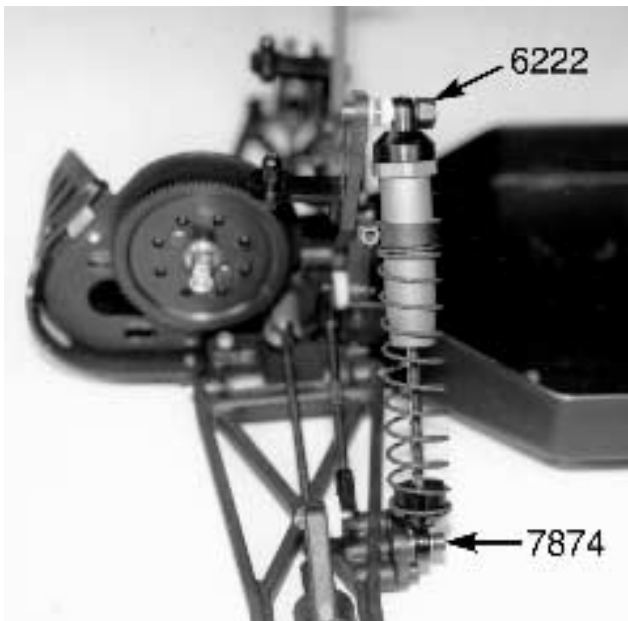
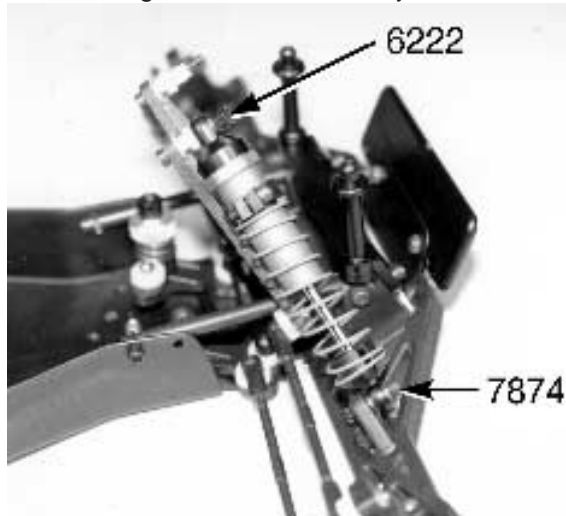

Fig. 135

□ **Fig. 136** (1) Take one of the front shocks and slide the shock cap over the upper shock bushing on the front shock strut. (2) From bag #7-10 remove two #6222 4-40/5-40 black self thread nylon locknuts. (3) Thread the #6222 nut onto the shock mounting screw to hold the shock cap in place. Only tighten the nuts just enough to make contact with the shock bushings, but not enough to cause binding.

(4) Go back to bag #7-10 and take out the two #7874 4-40 x 7/16" SHCScrews. (5) Now line up the pivot ball on the bottom of the shock with the outside shock mounting hole on the front suspension arm. Make sure the pivot ball is on the front side of the front arm mount. (6) Fasten the shock pivot to the arm with the #7874 SHCScrew. (7) Now do the same for the other front shock. Be careful not to overtighten the screws which can cause shock binding. Most drivers prefer to install their shocks with the spring clamp adjusting screws on the outside, facing forward, to make adjustment easier.



 #7874 4-40 x 7/16
  #6222 4-40/5-40 nylon locknut
 Fig. 136

□ **Fig. 137** This photo shows all four shocks installed onto the truck. We have now completed the chassis assembly.

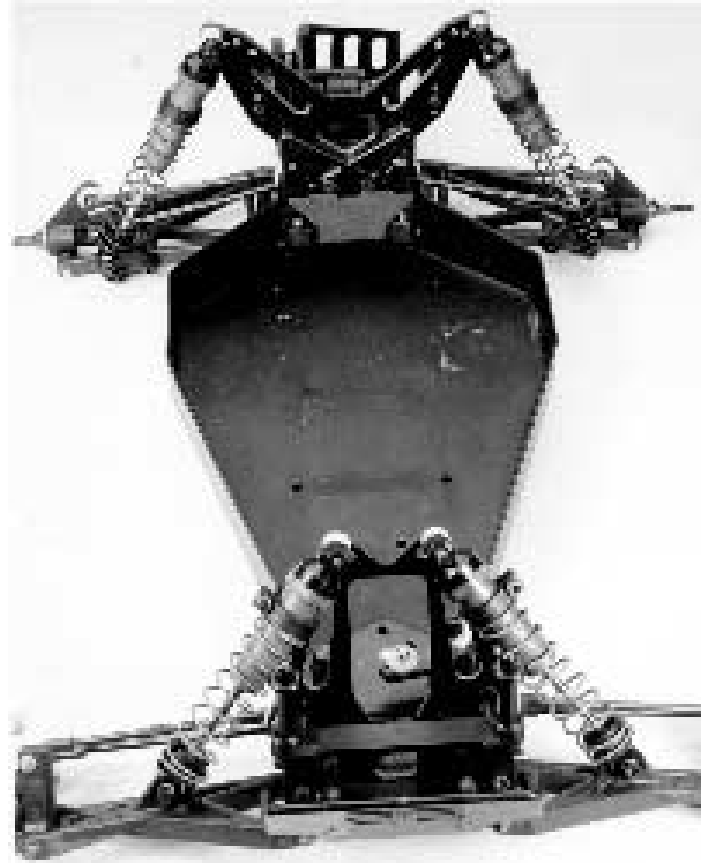

Fig. 137

STEERING SERVO SECTION

We are now ready to install the steering servo. If you have not purchased a radio yet, we recommend that you stay with a name brand company like Airtronics, Futaba, or JRpropo. However, it may be possible to use many other radios, including some stick models. This is something we recommend you determine before you purchase the radio system or you will need a written guarantee from the dealer that they will take it back if it will not work or fit correctly.

Because of the additional loads on the steering system (wider and heavier tires) we recommend using only medium sized servos with a minimum of 42 oz. in. of torque for the steering servo. Most quality radio systems come with medium sized servos that have torque ratings in the low 40's, but check the specifications just to be sure. **Racers Tip:** *If you want your truck to be able to perform a little better and more consistently, most racers look for a ball bearing servo. When used for their steering servo, they prefer a servo that has at least 55 oz. in. of torque.*

The speed of the servo will depend upon your preference. Standard servos have speeds normally between .22 to .24 sec. for 60° of travel. High speed servos have

speeds ranging from .06 to .19 sec. for 60° travel. Your choice will be determined by your driving skills as well as your budget because some of the high speed or high torque servos can be very expensive. Below you will find a chart which lists the servos that will bolt in or fit with only minor modifications. **WARNING!** We have determined that two of the high torque Futaba servos will not work unless you modify the servo mounting location in the truck. These are the S-9302 and the S-9303 servos. If you choose to use these servos, then making the servo fit will be your responsibility.

Guide to Recommended Servos

Airtronics	Futaba	JRpropo
94102	S148	5072
94322	S9403	5172
94737	S9304	47212
94738	S9402	47352
94151(Discontinued)		
94152(Discontinued)		
94155		
94156		
94157		

Note: Futaba servos require that you file the servo mounting tab holes so they are closer to the servo case to allow the #7527 servo mounts to fit closer to the servo case. See fig. 138. JRpropo servos may require that you trim the servo mounting tabs' outer edge to clear the steering servo saver and battery hold down strap. See fig. 139.

TRIM SHADED AREA

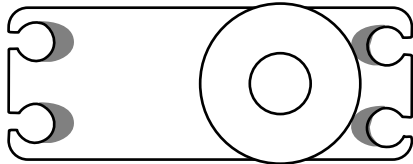

Futaba servos

Fig. 138

TRIM SHADED AREA

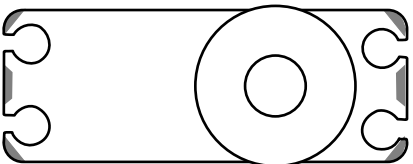

JRpropo servos

Fig. 139

The photos that follow show the installation of a Airtronics 94737 high torque, high speed ball bearing medium sized servo for the steering servo.

Figs. 140, 141 & 142 In bag #7-6 you will find the #9180 servo horn tree (see fig. 140). On the parts tree are servo horns that fit Airtronics, Futaba, & JRpropo servos. Each servo horn is marked with the first letter of the brand of radio the horn will fit.

Remove the correct servo horn from the parts tree. Now go to bag #6-14 and remove one #6270 short ball end. Thread the #6270 ball end into the #9180 servo horn from the back side as shown in fig. 141. This will place the ball end over

the servo when mounted. **Note:** KOpropo servos should be able to use the Airtronics servo horn. If you are using a different brand of servo and none of our servo horns will fit you must then use one of the stock servo horns that came with your servo.

Before you can install our servo horn you must remove the stock servo horn that comes installed on most servos. Now place the servo in front of you. With the output shaft facing you make sure the shaft is on the right side of the servo. Now install the servo horn so that it points straight up as shown in fig. 142. Before you secure the servo horn, rotate the servo horn to the right and left. We want to make sure the servo horn has almost the same travel in both directions. If not then you will need to remove the servo horn, rotate its mounting position by one or more splines and recheck until everything is correct. Your finished servo should look like fig. 142.

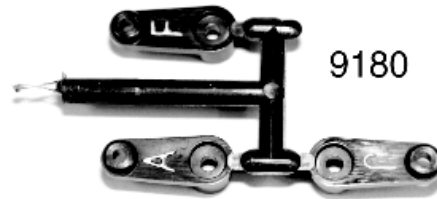

Fig. 140

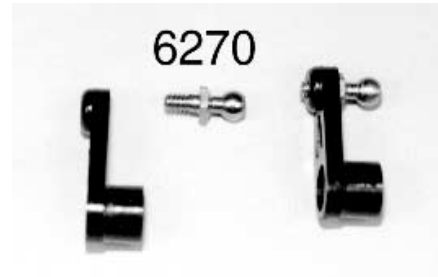
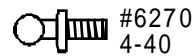

Fig. 141



Fig. 142



Figs. 143, 144, 145 & 146 In order to properly install the steering servo, we will need to make any servo modifications now. Refer back to figs. 138 & 139 for any modifications to be made to Futaba or JRpropo servos.

In bag #7-6 you will find the #7336 plastic servo mount parts (two mounts and two mount spacers) as shown in fig. 143. From the same bag remove four #6917 4-40 x 3/8" BHSScrews, and four #7337 servo shim washers (gold colored).

The drawing in fig. 144 shows the maximum standard servo length. If your servo is longer you will need to add the #7336 servo mount spacers. If your servo is smaller or

equal to the maximum servo length you will only need the two #7336 plastic servo mounts. The parts layout for a servo length of 1.40" or less is at the bottom of the fig. 145. The parts layout for a servo length over 1.40" is at the top of fig. 145. Both use the same four #7337 shim washers, and four #6917 BHSSscrews to secure the mounts to the servo. Your completed steering servo will look like fig. 146. Make sure that the servo output shaft is to the back of the truck when the servo is installed.



Fig. 143

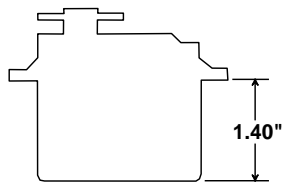

Fig. 144

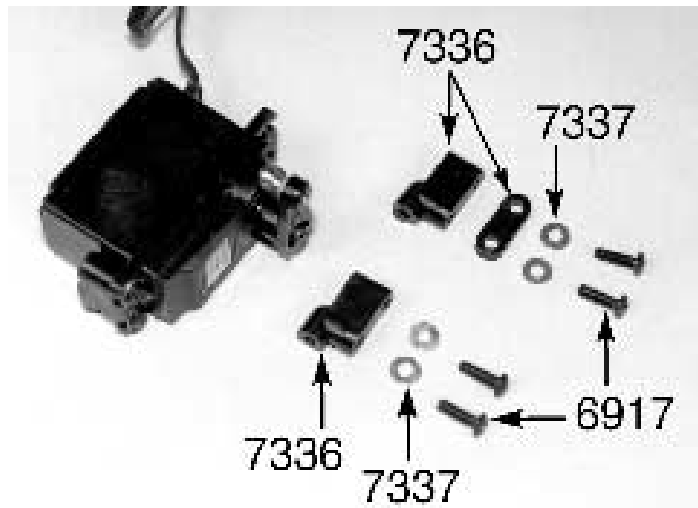

Fig. 145



Fig. 146

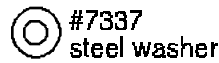
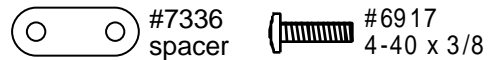

Fig. 147 & 148 Now we will use the two #6292 4-40 x 3/8" FHMScrews and the #6466 1/16" plastic spacer to mount the servo to the chassis. These are also in bag #7-6. The spacer will go on the rear screw as shown in fig. 147. Line up the screws with the holes on the bottom of the #7336 plastic servo mounts and thread them into the mounts. Your installed servo will look like fig. 148.



Fig. 147



Fig. 148

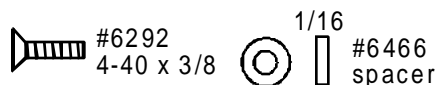

Fig. 149 & 150 In bag #7-2 you will find one #6262 1.65" turnbuckle. In bag #6-14 you will find the two remaining #6274 plastic ball cups. Evenly thread the ball cups onto the turnbuckle. The servo and servo mounting position will affect the length of this turnbuckle so we cannot give you a specific dimension. On this turnbuckle the left ball cup will face down and the right ball cup will face towards you. **WARNING! For some servos the turnbuckle supplied may be too long and will need to be shortened for proper installation. Threading on the ball cups too far will damage the ball cups and cause them to bind. Shorten the turnbuckle if needed before you install it.** Fig. 150 shows the servo turnbuckle installed on the truck.

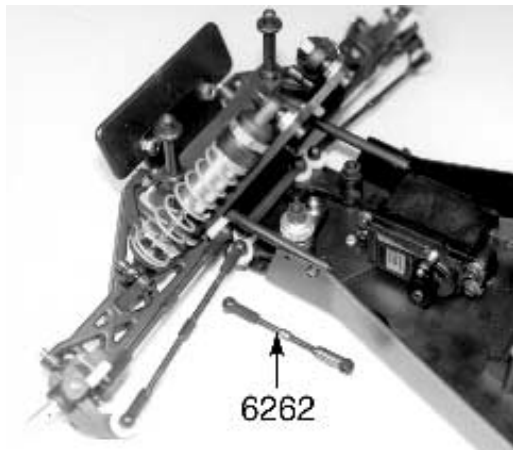

Fig. 149

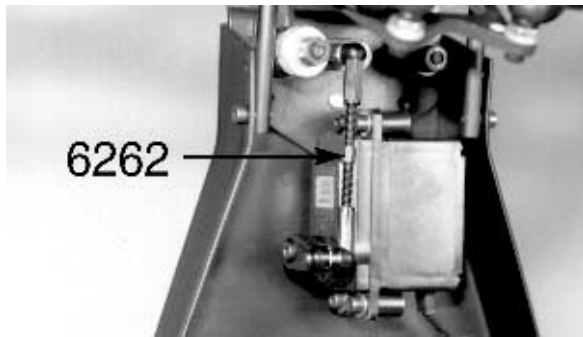
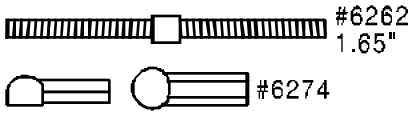

Fig. 150

□ **Fig. 151 & 152** In bag #7-7 you will find the #7327 front battery mount for the T2, two #6916 4-40 x 1/2" SHCScrews (with hole) and two #6292 4-40 x 3/8" FHSScrews. Thread the #6916 screws into the front battery mount as shown. We will adjust the height of the #6916 screws a little later in the instructions. Referring to fig. 152, use the two #6292 FHSScrews to fasten the front battery mount to the chassis.



Fig. 151

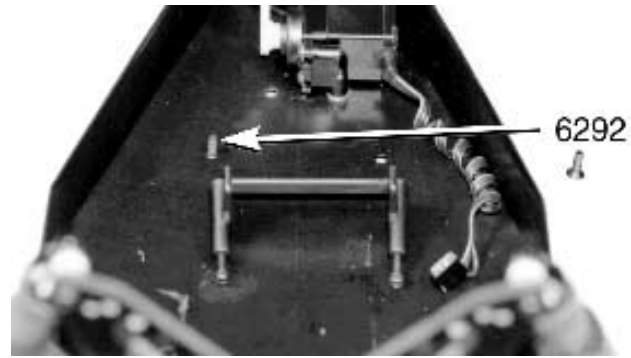

Fig. 152

MOTOR INSTALLATION

□ **Figs. 153 & 154 BALL BEARING KITS** do not come with a motor bag. This means you will need to supply your own motor, matching pinion gear, and capacitors. These can be purchased from most local hobby dealers. There is a chart in the tuning section of the manual that will give you a recommended pinion gear for most motors. If you have any questions, take your manual to your local dealer and he can assist you. If you have any motor assembly or installation questions, the following instructions for the bushing versions will also work for the bearing kits as well.

BUSHING KITS contains a motor bag. This would be inside the kit bag. Inside the motor bag you will find the kit stock motor, the motor connector plug (with wire leads), three .1uf (micro farad) capacitors and the bag containing the two #6515 motor screws and two #6936 #4 aluminum flat washers.

CAPACITORS We recommend the use of three .1uf (micro farad) capacitors on all motors used in our bushing kits. We supply three with the stock motor that comes in these kits. For the ball bearing kits since you will be using an electronic speed control, follow the speed control manufacturers directions for quantities, type and mounting locations for the capacitors.

If the motor you purchased already has one or more capacitors installed just add the ones you will need to bring the total to three. Open the motor bag and remove the three capacitors we supply. These will normally be a light brown or blue color. Solder the capacitors on as shown in the drawings in fig. 153. If your motor already has some installed just solder on the ones that are missing according to the drawings. **Note:** Make sure that each lead of a capacitor only touches a lead of another capacitor connected to the same terminal or can grounding point.

MOTOR CONNECTOR PLUG In the motor bag you will find the motor connector plug. This has two three inch wire leads coming out of the connector pins. Solder the end of the red wire lead to the positive side of the motor. Then solder the black or yellow wire lead to the negative side of the motor. Make sure you are using ROSIN core solder to make all electrical connections. **If you have a ball bearing kit you will not have a motor plug connector. Your speed control may supply one, you can purchase what ever style you like or you can hard wire. The choice is yours.**

STOCK MOTOR

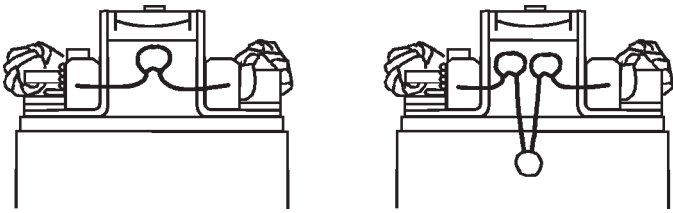

MODIFIED MOTOR

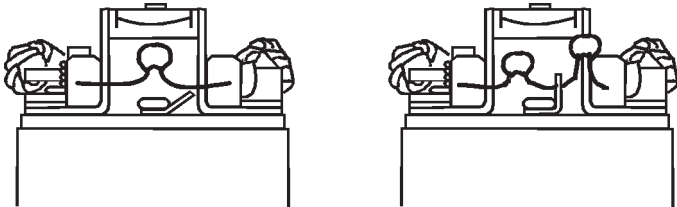

Fig. 153

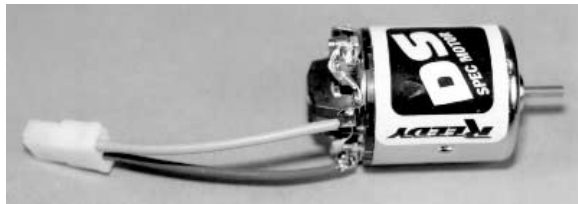

Fig. 154

□ **Fig. 155 & 156** We now need to install the pinion gear and mount the motor. If you have not picked out the motor you want to put in your ball bearing version now is the time to do so. Although any standard R/C car motor will fit, we highly recommend the Reedy Modified line of electric motors. These are the same motors that we race with and they have helped us win most of our World Championship titles. Check with your local dealer or call our factory for recommendations.

Go to bag #7-15 and remove the #6672 14 tooth pinion gear and the #6951 4-40 x 1/8" socket set screw. Remember you will only find this in the bushing kits. Fig. 155 shows a Reedy motor with the pinion gear next to it. Install the pinion gear on the motor shaft with the gear teeth closer to the motor can and secure it with the #6951 set screw (see fig. 156). For now you want the end of the pinion even with the end of the motor shaft. **Note:** Most American-made pinions use a 4-40 set screw and require a .050 Allen wrench, but some brands are metric. If yours is metric you will need to find a metric Allen wrench to fit it.

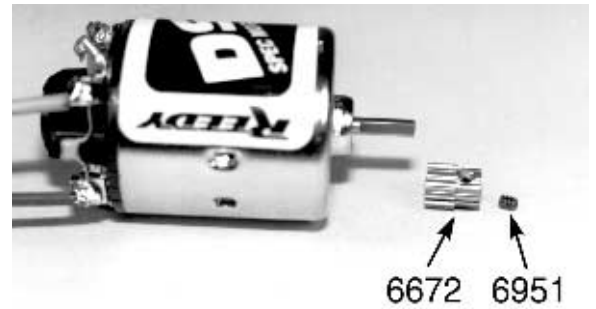

Fig. 155



Fig. 156

□ **Figs. 157 & 158 FOR THE BALL BEARING KITS** you will find the #6515 3mm x 6mm gold colored motor mounting screws along with two #6936 #4 aluminum flat washers in a separate small bag inside the kit bag. **FOR THE BUSHING KITS** the same parts will be in the motor bag.

Install the motor into the motor opening from the left side so that the shaft and pinion gear will stick through the gearing opening in the motor plate. Fasten the motor to the bottom motor mounting hole of the motor plate using the #6515 screw and #6936 washer as in fig. 157. Now install the upper mounting screw the same way (see fig. 158). **WARNING! Do not use any of the black 4-40 screws to mount the motor. The motor mounting holes are 3mm and the black 4-40 screws can strip out the holes in the motor can, making the motor unusable.**

Now we need to set the gear mesh. By moving the motor forward or back we will be moving the motor pinion gear closer to or away from the nylon spur gear. What we want to do is get the metal pinion gear as close to the nylon spur gear as we can without binding the gears. The easiest way to check this is to put your finger on the plastic gear and see if you can rock it in the teeth of the metal gear, but without the metal pinion gear moving. The gears should be as close as possible, but still have the ability to rock the plastic gear with just very light pressure. When you have the spacing correct you can tighten down on the motor mounting screws. Now recheck the gear spacing. It is important to keep in mind that a tight gear mesh can result in a huge power loss and shortened battery time, so do it correctly.

□ #6515 3 mm x 6 mm metric (gold) ○ #6936 #4 flat washer aluminum

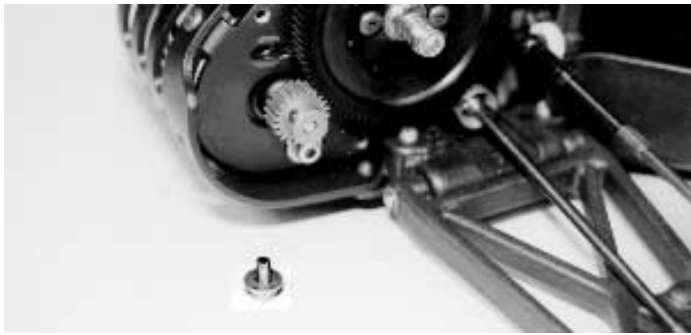

Fig. 157



Fig. 158

□ **Figs. 159, 160 & 161** In the Stealth transmission bag you will find the bag containing the new #7372 T2 gear dust cover and black insert button. In the same bag you will find two #6288 4-40 x 1/4" BHSScrews. Trim the edge of the plastic gear cover so that it will fit over the motor plate. You will also need to trim the center hole for the black insert button. Now drill out the two mounting holes in the gear cover for the #6288 screws. Secure the cover to the motor plate with the #6288 screws and install the black insert button. Fig. 161 shows the button removed and adjusting the Associated Torque Clutch using a 1/4" nut driver.

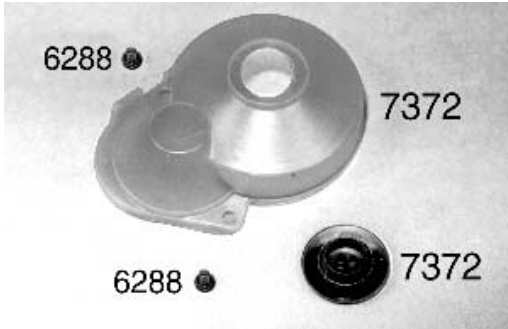

Fig. 159

□ #6288
4-40 x 1/4



Fig. 160



Fig. 161

THROTTLE CONTROL ASSEMBLY AND INSTALLATION

The following assembly only applies to the BUSHING KITS. If you have a BALL BEARING KIT you will NOT have a bag #6-13. You can skip forward in the manual to fig. 175

□ **Fig. 162** From your bushing kit you will need to locate and remove bag #6-13. This contains the parts to assemble our mechanical throttle control. This is a race legal resistor style throttle control which has a nine step forward and a five step brake circuit. **THIS RESISTOR DOES NOT HAVE REVERSE.** The following steps show you how to assemble, install, and adjust the mechanical speed control using our new mount and bracket system. **Note:** The new throttle servo mounts will only fit a medium size servo (this is what is standard with most of the major radio systems).

Open bag #6-13 and remove the two #7527 throttle servo mounts, four #6932 4-40 x 5/16" socket head cap screws, and four #6936 #4 aluminum flat washers. Arrange your servo and servo mounts as in fig. 162. Now secure the servo mounts to the servo using the #6932 screws and #6936 washers.

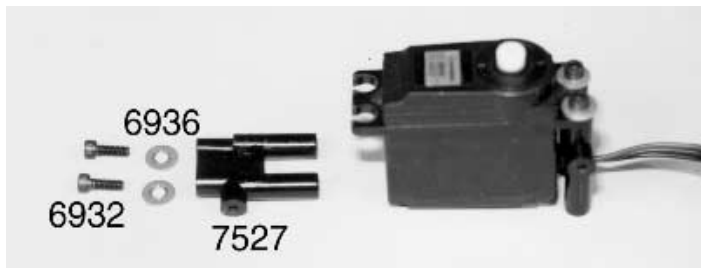

Fig. 162

□ **Figs. 163, 164 & 165** (1) From the same bag remove the two #8850 black aluminum throttle resistor brackets, the #6711 throttle resistor, two #6932 4-40 x 5/16" socket head cap screws, and two #6936 #4 aluminum flat washers. There is a left and a right side to the two resistor mount brackets. (2) We will start with the left bracket as shown in fig. 163. Use one of the #6932 screws and #6936 washers to secure the left bracket to the left side mount. Make sure the bracket bends away from the servo. We want the top of the bracket to also be parallel with the ground. (3) Look closely at the throttle resistor. You will see that there is a slot running through the center of the resistor. This is how it will be mounted. Now we can take the #6711 throttle resistor and slide it onto the left bracket (see fig. 165). Make sure the solder tabs on the resistor are facing away from the servo and that the silver bands are facing up. (5) Next we can pick up the right side bracket and slide it into the slot from the right side. (6) The small slot on the lower portion of the bracket needs to be lined up with the mounting hole on the right servo mount. (7) Use the remaining #6932 screw and #6936 washer to secure the bracket to the right mount. **Note:** The brackets have vertical slots for the mounting screws. This will allow us to adjust the height of the resistor to make sure we have good electrical contact between the resistor and the wiper arm when used with different servos.



Fig. 163

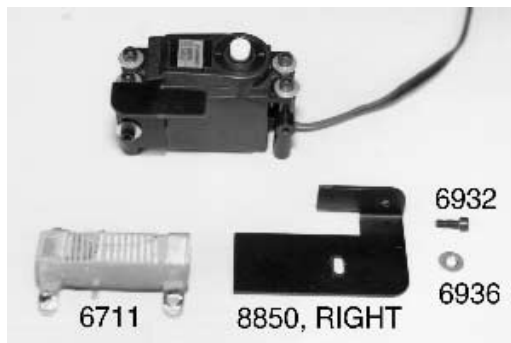

Fig. 164

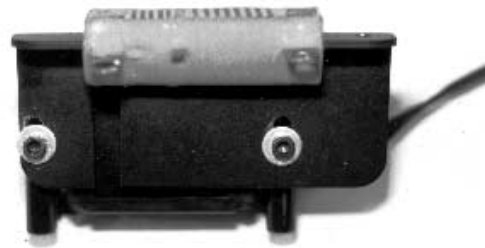

Fig. 165

□ **Figs. 166, 167 & 168** (1) Still working with bag #6-13 we will need to remove the #6712 throttle wiper arm, one #3721 #2 x 1/4" sheet metal screw, and one #3721 #2 flat washer (there is normally an extra #3721 screw and washer). (2) Look at the servo horns that came on or with your servo. Fig. 166 shows five of the more common servo horns used by the major manufacturers. The ideal design (for this application) is the small round servo horn shown in the center of the photo. The other servo horns will work but they do require trimming so they will not interfere with the wiper arm movement. (3) Push the chosen servo horn back onto the spines of the output shaft of the servo but do not secure it. (4) Place the #6712 wiper arm over the servo horn. Make sure the button on the wiper arm is facing down (towards the resistor bands). (5) The screw that was holding the servo horn that came on your servo will go through the center slot in the #6712 wiper arm, then the servo horn and secure both parts to the servo. Install this screw for now but do not secure it. (6) Now look at the bottom of the round portion of the wiper arm. You will see a small hole. Rotate the wiper arm on the servo horn until the small hole will line up with one of the holes in the servo horn. You have a little up and down movement with the wiper arm to help make sure everything will line up correctly with a hole. (7) When you find a hole that lines up, go ahead and secure the wiper arm to the servo horn with the #3721 screw and #2 washer. (8) Now remove the servo horn mounting screw then the servo horn/wiper arm assembly. We want to line up the wiper arm over the wide neutral band on the green throttle resistor. The output shaft of the servo is splined so you can rotate the servo horn assembly one spline at a time to adjust the starting position. Once you have it lined up correctly go ahead and resecure the servo horn assembly with the servo horn screw. **Note: This is just a basic setup. We will make final adjustments when we do our final radio setup at the end of the instruction manual.**

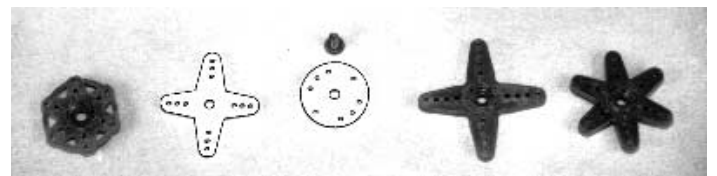

Fig. 166

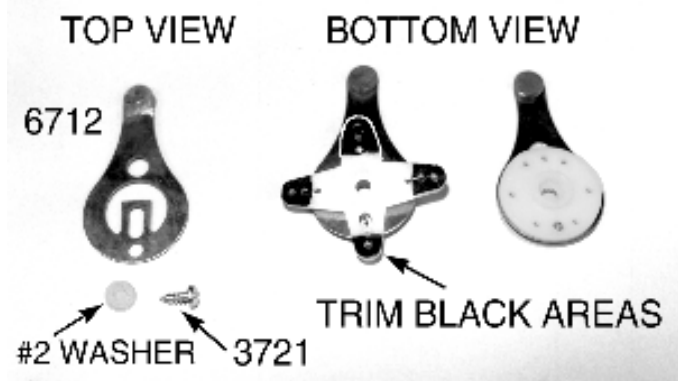

Fig. 167

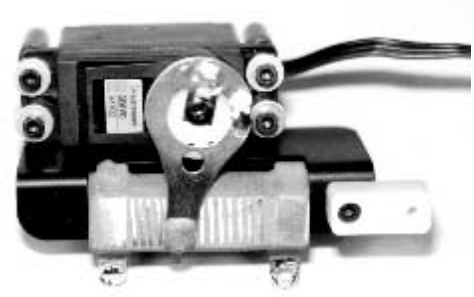

Fig. 168

□ **Figs. 169, 170 & 171** (1) Take out the #6714 yellow nylon throttle bypass mount, one #6925 4-40 x 1/2" socket head cap screw, and one #6295 4-40 steel locknut. (2) If you look at the #6714 mount you will see there are two holes. On one side of the mount one hole is recessed. Install the #6925 screw into the recessed hole (the head of the screw will be below the surface) and then through the hole on top of the right resistor bracket. (3) Thread the #6295 locknut onto the #6925 screw to secure the bypass mount to the bracket. (4) In the same parts bag you will find the #6714 brass throttle bypass tab and one #6924 4-40 x 3/8" socket head cap screw. (5) Place the bypass tab on top of the mount with the bent end down so that it is closer to the #6711 throttle resistor. (6) Use the #6924 screw to fasten the tab to the mount. To make sure everything is correct rotate the wiper arm so that it goes under the bypass tab. The wiper arm is suppose to fit snugly between the resistor and bypass tab. If not you can either adjust the position of the resistor by raising the mounting brackets or you can bend the end of the bypass tab down so that it makes more contact with the wiper arm. Fig. 171 shows your throttle servo assembled.

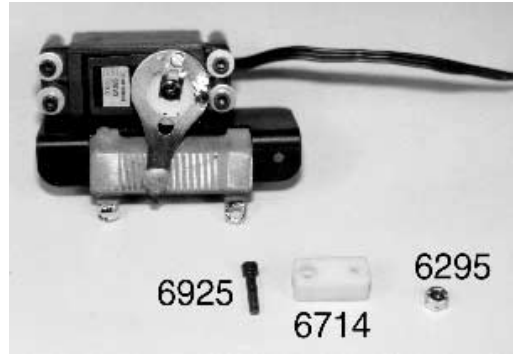

Fig. 169

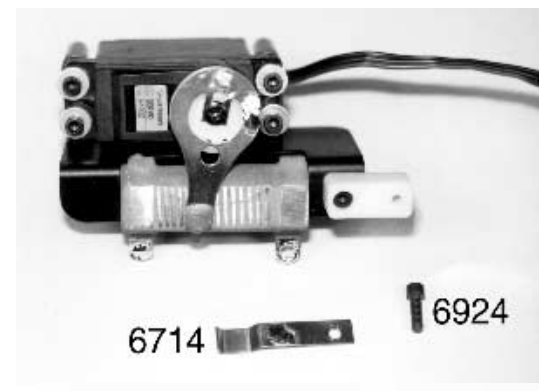

Fig. 170

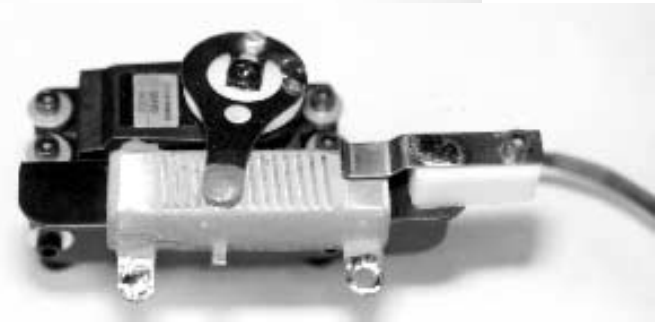

Fig. 171

□ **Figs. 172, 173 & 174** We are now ready to fasten the throttle servo to the chassis. Remove two #6292 4-40 x 3/8" flat head socket screws from bag #6-13. We will use these to secure the throttle servo mounts to the chassis. There are two holes on the left or drivers side of the chassis just outside the battery area. Now look at the bottom of the servo assembly. There are four mounting holes on the bottom of the servo mounts. We will only be using the two under the resistor brackets. Now place the servo in the chassis and line up the mounts with the mounting holes. Use the #6292 screws to secure the servo mounts to the chassis.

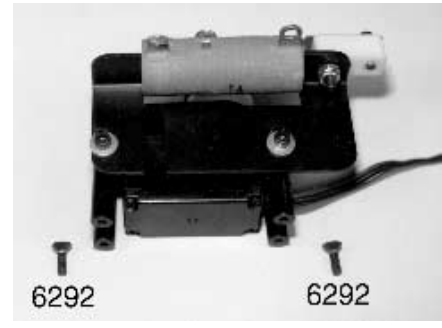

Fig. 172



Fig. 173

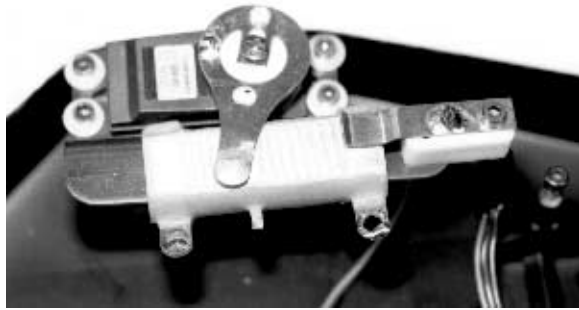

Fig. 174

□ **Fig. 175, 176 & 177** Now we can begin to connect the wire harness for the throttle resistor and battery pack. (1) In bag #6-13 you will find a small 2 inch piece of red 16 guage wire. (2) Solder one end of this wire to the #6714 brass bypass tab. Then solder the other end to the closest tab on the #6711 throttle resistor. This will be the positive terminal on the resistor. You can shorten the wire to improve the efficiency and appearance of the connection. See fig. 175.

(3) Next remove the #6747 battery input power harness (with B.E.C. plug). Solder the large red wire to the positive tab on the throttle resistor. Now solder the large black wire to the negative tab on the same throttle resistor Fig. 176 shows this harness installed on the throttle resistor. (4) The last harness we need is the #6745 motor output plug. For this plug we will solder the red wire to the #6712 brass wiper arm on the servo. We will then solder the black wire to the negative tab on the left side of the throttle resistor. Fig. 177 shows this harness plug installed. Now connect the #6745 motor output plug to the motor plug that is soldered onto the motor. Your mechanical throttle control is now assembled and installed. We will check the setup and make any adjustments in the final adjustments section later in the manual.

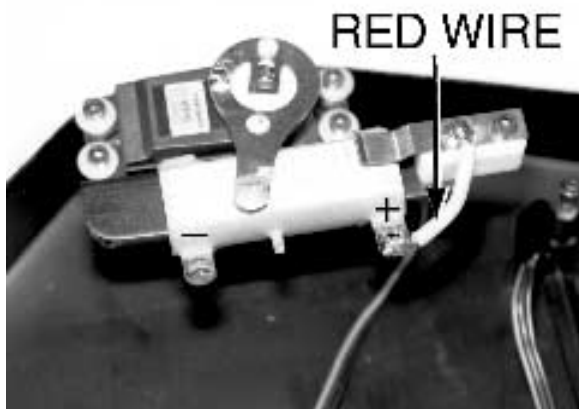

Fig. 175

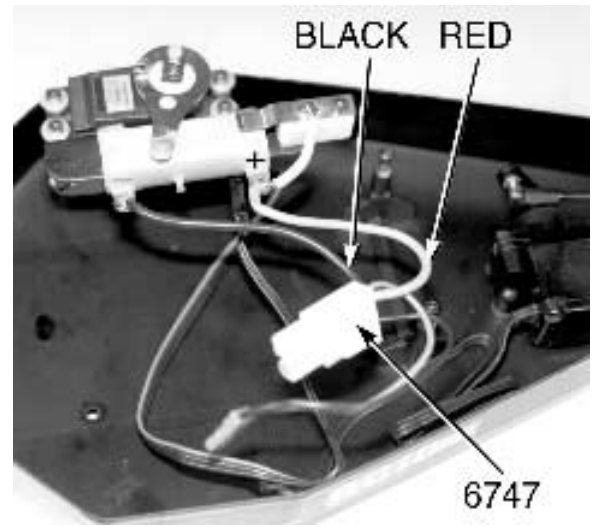

Fig. 176

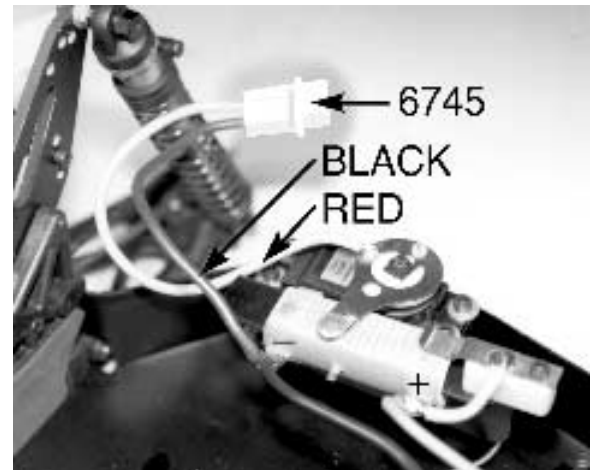

Fig. 177

□ **Fig. 178 FOR BALL BEARING KITS** we are now going to install the electronic speed control. If you have not decided on a speed control yet, we recommend using a name brand like LRP, Novak, or Tekin. We consider this to be the top brands from Europe and the U.S. As long as you stay with a quality brand you should have no problems. **NOTE: Bushing kit owners will need to follow this step if you ever decide to upgrade to an electronic speed control.**

In your kit bag you will find a two strips of double stick servo tape. trim a piece to fit the bottom of the ESC (electronic speed control) case. Peel the backing from one side and secure the tape to the case. You want to mount the ESC in the back left corner of the chassis as shown in the photo. Try to mount the ESC so that air can flow through the FET's or heat sinks, if possible. Now cut a small piece of double stick tape to fit the on/off switch on the ESC and use it to secure the switch in the position you want.

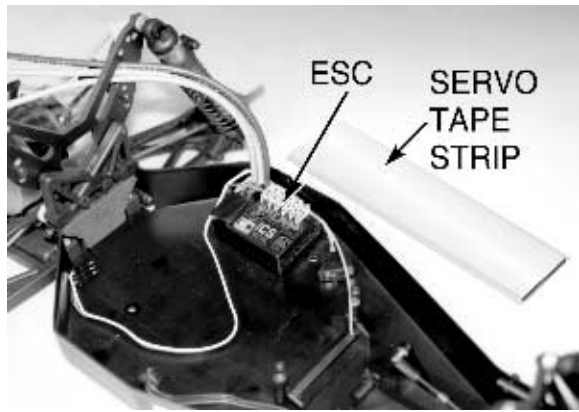

Fig. 178

□ **Figs. 179, 180 & 181** We can now install the radio receiver. In the master bag you will find the plastic antenna tube. Attached to the tube you will find a small bag containing the #6338 antenna mount, one #6922 4-40 x 1/2" FHSScrew and the black antenna tube cap (see fig. 179). Before we mount the receiver we need to assemble and install the antenna mount. Take one end of the antenna tube and push it into the antenna mount. Cut the antenna tube so that it is about 15 inches long.

We are going to install the radio receiver on the right side of the chassis. Near the back of the chassis on the right side you will find one hole which is counter sunk on the bottom of the chassis. This is our recommended antenna mounting location. Mount your receiver forward of this location. You need to make sure that the servo plug from the steering servo, throttle servo (or ESC) can easily reach the receiver. We also want the antenna wire to have a clear run to the mounting location for the antenna mount. Take out one of the double stick tape strips (also know as servo tape) from the kit bag. Ball bearing kit owners will have already done this in fig. 178. Cut a piece to fit on the bottom of the receiver case.

Racers Tip: Team drivers will sometimes use two layers of servo tape to help provide better shielding from electrical interference.

Fig. 180 shows the receiver installed, with the antenna wire run through the antenna tube and the antenna mount ready to be secured to the chassis with the #6922 screw. You want a couple of inches of the antenna wire coming out the top of the antenna tube. Now push the black antenna tube cap over the end of the tube and the antenna wire. This will prevent the antenna tube from pulling out during a race. **Racers Tip:** Keep the antenna tube as long as possible for radio range (about 15 inches or so), but not to the point where it could get caught in the wheels or some other else. **WARNING! Do not cut the radio receiver antenna wire. Cutting this wire could detune the receiver, causing severe radio interference or glitching problems. Each receiver is tuned to the length of antenna wire that comes attached to it.** If you have excess antenna wire, the appropriate way to store it is to wrap the excess around a piece of cardboard or plastic as shown in fig. 181. Make sure the antenna wire does not cross over itself. This can make the antenna act as a shorter antenna and reduce the radio receiving range. You should mount the excess coiled an-

tenna on top of the receiver with a piece of servo tape.

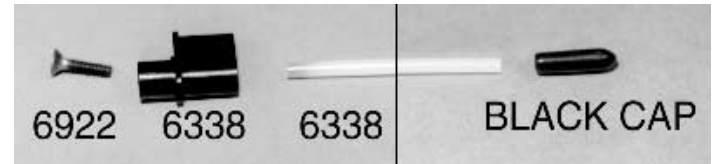

Fig. 179

#6922
4-40 x 1/2



Fig. 180

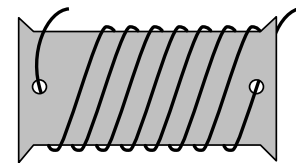

Fig. 181

Do not cut your antenna wire. Wrap any excess wire around a piece of cardboard or plastic cut as shown. Do not let the antenna wire cross over itself.

□ **Fig. 182** Now we can connect the steering servo and speed control plugs to the receiver. We will start by inserting the steering servo plug into the channel 1 (or rudder) slot on the receiver. You can coil the servo wire or bundle the excess and secure it with a wire tie supplied in the kit. If you decide to coil the wire you can wrap it snugly around a pencil. If you bundle the wire keep the bundle close to the servo to help prevent any interference problems. Next we need to install the throttle servo or ESC plug into channel 2 (or throttle) on the receiver. Route the servo wire (from the speed control) across the chassis so that it will end up under the battery and battery pad. Run it straight across not at an angle. We will protect this wire in a moment.



Fig. 182

❑ **Figs. 183 & 184** From the #7-7 parts bag remove the #7329 battery foam pad. We need to install the pad so that it will go from the rear bulkhead then forward over the speed control wire and front battery mount as shown. Fig. 184 shows the installation with the ESC, but it will be the same for the throttle servo.

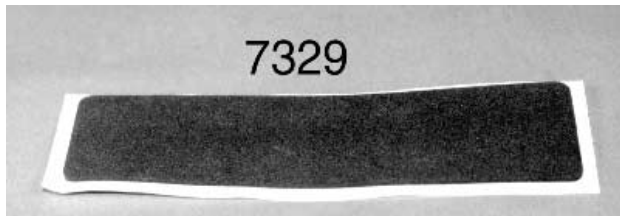

Fig. 183



Fig. 184

BATTERY PACK ASSEMBLY

Your truck kit does not come with a battery pack. It will work with most 6 or 7 cell flat packs either pre assembled or matched hand assembled. The following basic instructions are included to help a first time user assemble and install a six or seven cell matched battery pack. For those of you who are using pre assembled pack you will just have to plug the battery into the matching plug from the throttle servo or ESC.

To solder a battery pack there are two important things to keep in mind. First, use a good soldering iron with no less than 40 watts of power. It is possible to use a soldering gun, but they are bulky, awkward, and do not apply the heat to the tip as well as a soldering iron. Make sure you tin (lightly solder) each part before you try to assemble them. This improves the heat transfer during soldering and the parts will bond better and faster. Second, use a high quality 60-40 rosin core solder. Small diameter solder is easier to work with. **WARNING! Do not use "acid" core solder. Acid core solder will damage electrical components. Use only ROSIN core solder for electrical connections.**

❑ **Figs. 185, 186 & 187** The first two drawings show the recommended wiring layout for both six and seven cell hand assembled battery packs using an electronic speed control. The third drawing shows the recommended wiring layout using a six cell pre-assembled battery pack along with the mechanical throttle resistor that comes in the bushing kits.

With electronic speed controls the first thing to keep in mind is to keep the positive lead as short as possible. This helps to reduce power loss and improves efficiency. Therefore, because the speed control (ESC) is mounted on the driver's side rear corner, the positive terminal of our battery pack should be in the same corner. Also, for our battery pack to have the correct voltage for our application, the cells will need to be soldered in series. This means the positive end of the first cell will need to be soldered to the negative end of the second cell, and its positive end will be connected to the negative end of the third cell, and so on. More details on soldering the battery are in figs. 188-191.

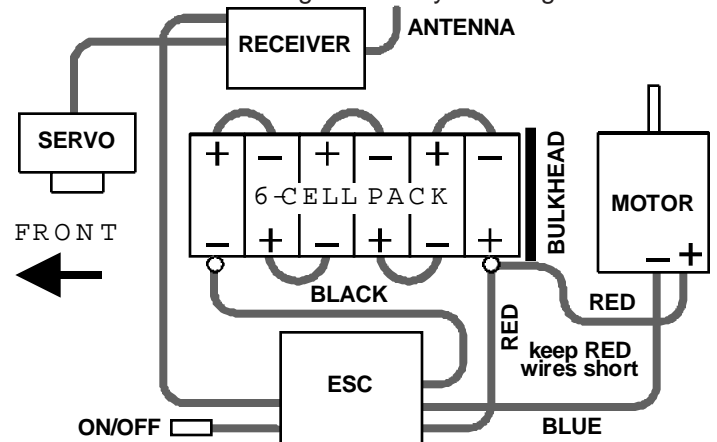

Fig. 185

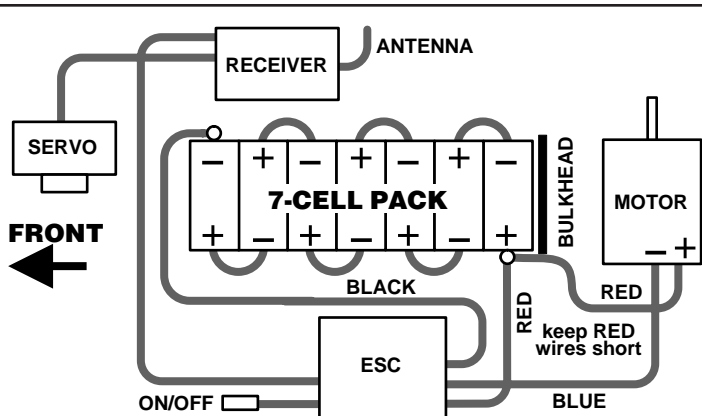

Fig. 186

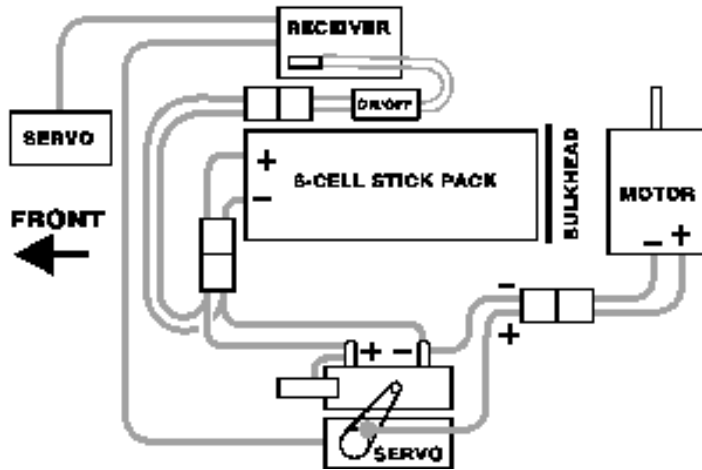

Fig. 187

❑ **Figs. 188, 189, 190 & 191** In order to connect matched cells together you will need to use battery braid or battery bars. Battery braid is cheaper and easier to solder, but battery bars help to make the battery pack more rigid and provide better conductivity. Associated sells Reedy #650 precut battery braid or #651 silver plated battery bars for soldering battery packs. You will also need to choose what type of connector or pin system you want to use between the speed control and battery pack. We show using the Reedy #652 power connector pins in the photos. Figs. 188 & 189 show braid and pin locations for both sides of a six cell battery pack. Figs. 190 & 190 show both sides of a seven cell battery pack.

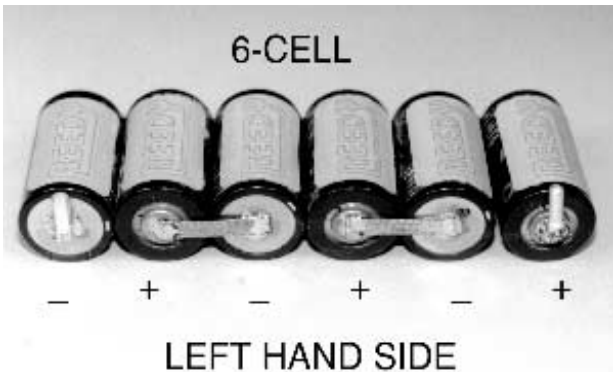

Fig. 188

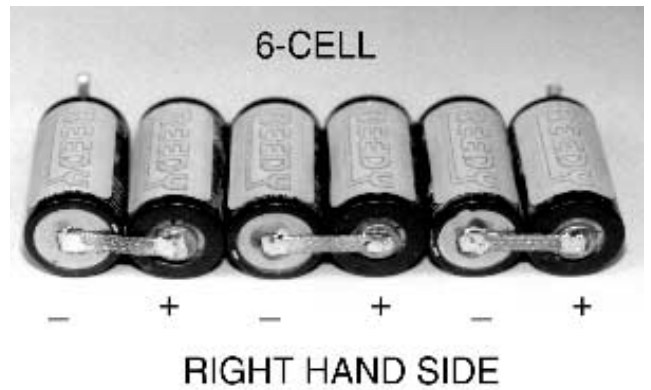

Fig. 189

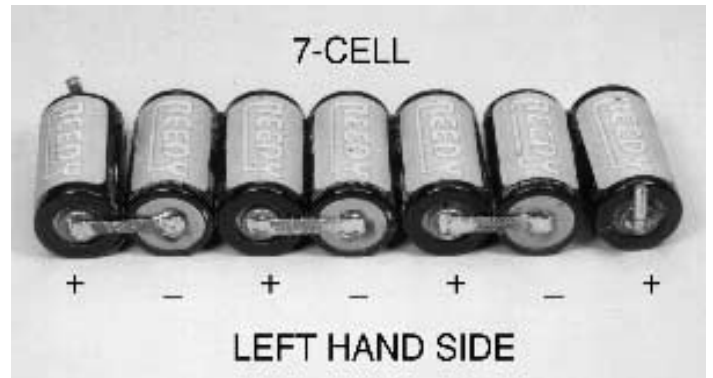

Fig. 190

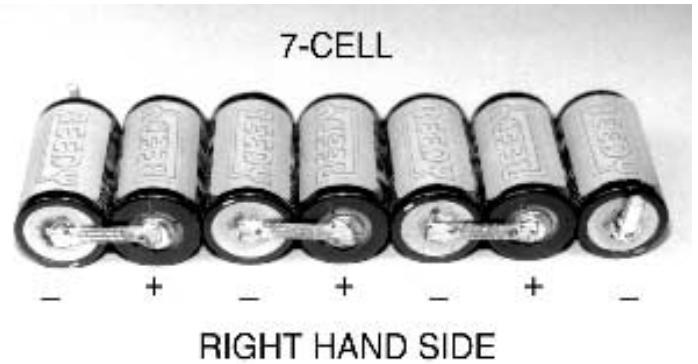

Fig. 191

❑ **Fig. 192** Go ahead and place your battery pack inside the chassis. If you have a pre-made battery pack make sure the wires are at the front. If you have a hand assembled pack make sure that the positive battery pin is located in the back left corner of the chassis. The photo shows a six cell battery pack installed.

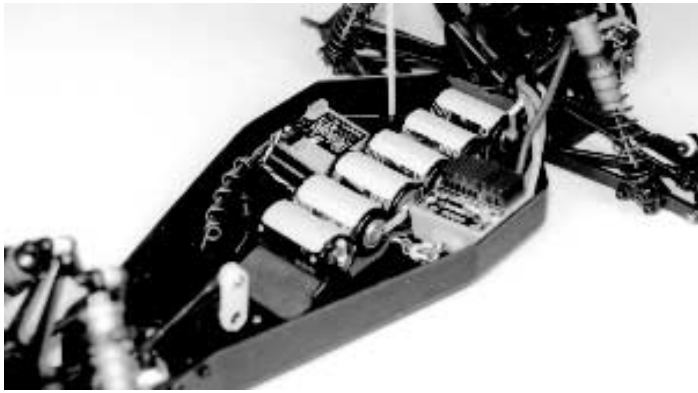

Fig. 192

□ **Figs. 193 & 194** In bag #7-7 you will find the #7326 molded battery brace. If you are running seven cell 8.4 volt battery packs this is all you will need to remove. If you are running six cell battery 7.2 volt battery packs you will also need to remove one #7328 battery brace 6-cell stop and two #6917 4-40 x 3/8" BHSScrews. For six cell packs install the #7328 stop so that the flat side of the stop is facing the narrow end of the #7326 battery brace.

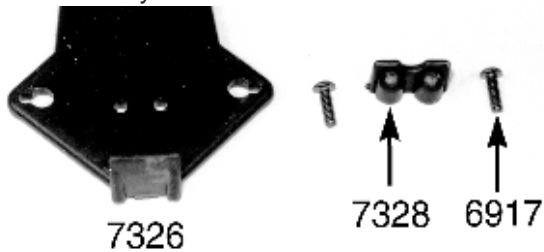

Fig. 193

#6917
4-40 x 3/8

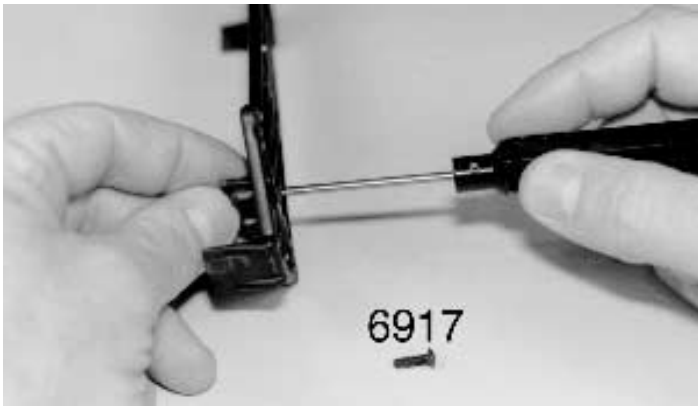

Fig. 194

□ **Fig. 195** Now we need to install your battery brace. This new brace locking tip interlocks to a rectangular hole in the rear bulkhead. After the tip has been inserted, rotate the brace down and over the battery pack. As the brace is rotated down it will get tight and then free up as the lock properly engages.



Fig. 195

□ **Figs. 196 & 197** To secure the battery brace you need to slide one side of the battery brace over one of the front battery mount screws, then squeeze the front battery mount so that you can slide the other side over the second screw. Now we can adjust the height of the #6916 front battery mount screws. The screws should just be low enough so that you can get the brace on without problems. They should also be high enough so that the brace will not slide up and down on the screws. The #6916 screws are drilled and we have also supplied some #6332 body pins so that you can secure the brace to the #6916 screws if you choose, but they are not necessary.



Fig. 196

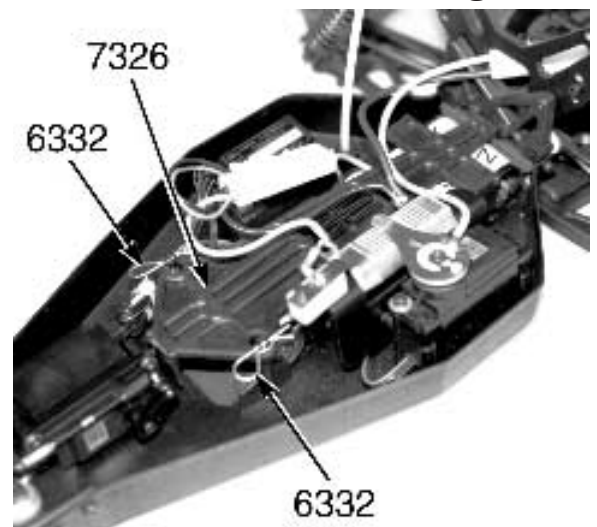

Fig. 197

❑ **Figs. 198 & 199** For electronic speed controls we need to finish the wiring between the ESC and the battery. If you look closely at the battery you will see that the positive terminal has the pin side of the connector soldered to it and the negative terminal has the socket side of the connector soldered to it. This is done so that you cannot connect the leads to the wrong end of the battery. Gently push the matching positive connector socket onto the connector pin. Taking the red positive lead from the speed control, measure the wire so that it will be as short as possible but not so short that you cannot easily remove or install the socket from the pin. Cut your wire and solder it to the socket. **Note:** If you have a four wire speed control, it does not matter which red (or orange) wire goes to the battery. The second red wire then goes to the motor. Now take the piece of red wire you cut off and solder it to the opposite side of the connector socket. This wire will then connect to the motor at its other end. Next gently install the connector pin onto the negative terminal connector socket.

Now take the black wire from the speed control and route it so that it will be as short as possible, but not be hard to remove or connect. Cut the wire and solder it to the connector pin. **Racers tip:** If you are going to run both six and seven cell battery packs make sure you leave the black battery wire long enough so that it can reach the negative connection points for either battery setup.

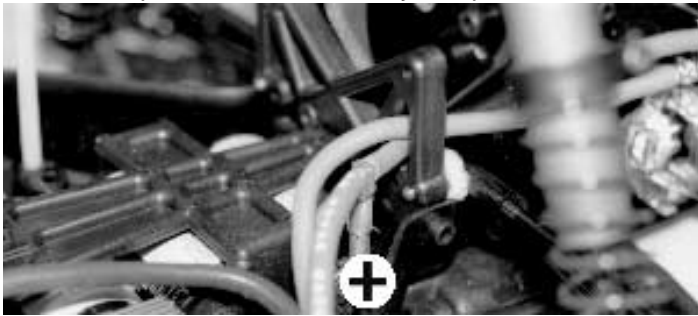

Fig. 198



Fig. 199

❑ **Figs. 200 & 201** If you have plug connectors for the motor run them over the top of the rear bulkhead. If you are going to hard wire the motor (solder the wire directly to the motor) slide the blue and red wires that go to the motor through the opening in the side of the rear bulkhead. Now measure the motor lead wires and cut them to the correct length. Make sure you leave some slack in the wires for motor

adjustment. Now go ahead and solder the wires to the motor. Make sure the red wire is soldered to the positive side and the blue wire is soldered to the negative side. **WARNING!!:** Some speed controls use different color wires. Always double check your speed control owners manual to verify that their wiring instructions match ours. If they are different follow the instructions from the ESC manufacturer.



Fig. 200



Fig. 201

WHEELS AND TIRES

Note: BECAUSE WE ARE CONSTANTLY IMPROVING THE PERFORMANCE OF OUR TRUCKS, THE TIRES IN YOUR KIT MAY VARY FROM THOSE SHOWN IN THE PHOTOS. IF WE FIND TIRES THAT WILL IMPROVE THE HANDLING OF THE TRUCK, WE RESERVE THE RIGHT TO CHANGE THEM AT ANY TIME.

The bushing kit comes with different wheels and tires than the ball bearing kit. We will cover both assemblies at the same time.

❑ **Figs. 202 & 203** For Ball Bearing kits remove the #7822 Proline XTR-M2 "Mini Pin" rear tires and the #7803Y fluorescent yellow one piece rear wheels from the rear tire and wheel bag. **Note:** These wheels will only fit the new #7367 rear universal dogbone axles; they will not fit the original #7362 truck universal dogbone axles or the #6374 rear stub axles in the bushing kits. The foam inserts come already installed in the tires but make sure they are centered evenly in the tire. Now we can install the rear tires onto the one piece wheels. Make sure you seat them evenly on the wheel. **Racer's Tip:** Before we install the rear tires onto the

wheels we need to drill two holes about 1/8" in size into the middle of the wheels or tire tread so the tire can ventilate. This will make the tire's performance more consistent.

Now you need to carefully glue the tires to the wheels using Super Glue (Cyanoacrylic glue) as follows. Very carefully push the tire away from the edge of the wheel, just enough to create a small gap between the tire and the outer edge of the wheel. Now place some Super Glue in the gap so that the glue will bond below the outer edge. Do this in about five or six places around the wheel. Make sure this glue is completely dry before you turn it over and glue the other side. **WARNING! Always wear eye protection and gloves when working with adhesives. Follow the manufacturer's directions for proper use and safety.** Now go ahead and do the same for the other wheel and tire. **Racer's Tip:** To make sure they have a round tire Team drivers will place a heavy rubber band around the outer edge of the tire they are gluing to the rim. The rubber band will help to keep the tire concentric all the way around the rim.

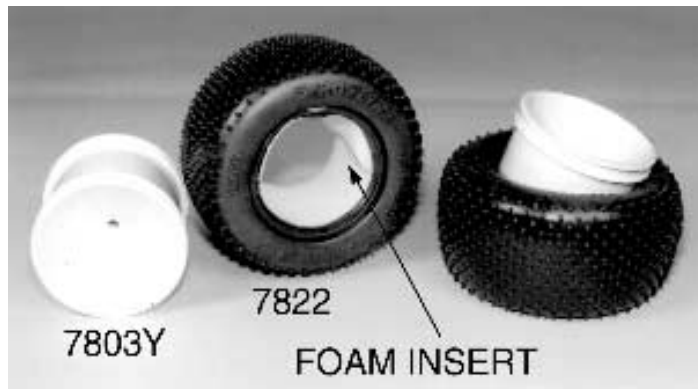

Fig. 202



Fig. 203

□ **Fig. 204 & 205** For Bushing Kits. Remove the two #7800Y fluorescent yellow three piece rear wheels, two #7823 rear Proline XTM "Stubbie T" tires and eight #6926 4-40 x 5/8" socket head cap screws.

Racers Tip: Before we install the rear tires onto the

wheels we need to drill two holes about 1/8" in size into the middle of the wheels or tire tread so the tire can ventilate. This will make the tire's performance more consistent. We will start by inserting the nylon inner sleeve into each of the rear tires. Carefully center the inner sleeve. Now we will start with the outer half of the rear wheel. Press it into the center of the rear tire and make sure the tire is evenly seated on the wheel. Now turn the tire over and install the back half of the rear wheel. Line it up with the mounting holes and center hole before you press the back half into the tire. Make sure that the tire is evenly centered on the wheel. Take four of the #6926 4-40 x 5/8" screws and thread them into the front of the wheels. They will go through the outer half and actually thread into the back half. Do not over tighten and do your best to keep equal pressure on all four screws so the wheel will not warp.

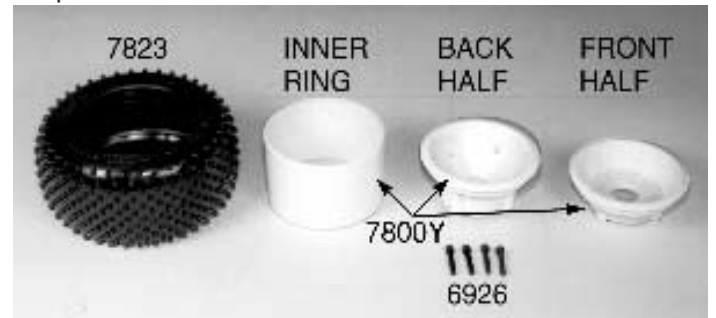

Fig. 204

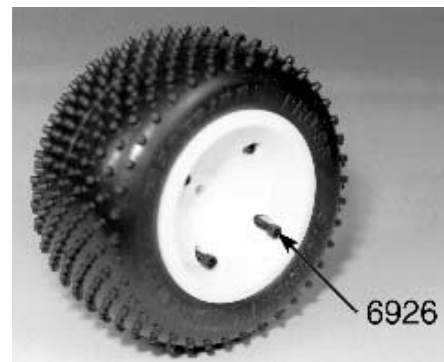
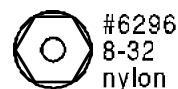

Fig. 205

□ **Fig. 206** Now we can install your rear wheels and tires onto the rear axles. All kits will install the same way. Line up the slots in the back of the wheels with the rollpin in the rear axle. Now press the wheel and tire on until the wheel seats over the roll pin. In bag #7-8 you will find two #6296 8-32 aluminum nylock rear axle locknuts. Thread one locknut onto each rear axle to secure the wheels and tires after they have been installed. An 11/32" nut driver #SP-82 will make it easier to tighten the nuts.



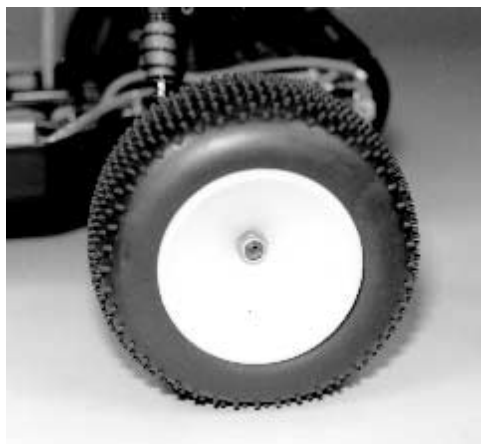

Fig. 206

Ball bearing kit wheel shown

□ **Figs. 207, 208 & 209** For Ball Bearing kits remove the front tire and wheel bag from the kit box. Take out the two #7842Y fluorescent yellow one piece front wheels, two ##7875 Proline XTR "Edge" front tires, and the small bag that contains the four #6906 3-16" x 3/8" unflanged ball bearings. **WARNING! The bearing bag is very small and is loose inside the tire/wheel bag. Be extremely careful when removing the tires and wheels so that the bearing bag does not get lost. It is also possible for the bearing bag to get wedged inside the front tires. If you do not see the bearing bag check the inside of each tire before removing it from the bag.**

Again, the foam inserts have already been installed for you. Go back to fig. 202 & 203 and follow the same procedures used to assemble and glue the rear wheels and tires. **Racer's Tip:** The "Edge" front tires have different tread patterns on each side of the tire. We recommend installing the tire so that the three "V" shaped grooves are to the outside of the wheel when installed. This will give you the most aggressive steering. When mounted facing the other way you will have less steering.

For Bushing kits Take out the two #7840Y fluorescent yellow three piece front wheels, two #7870 "Block Ribbed" front tires, and the small bag that contains the four #6599 3/16" x 3/8" unflanged bushings. **WARNING! The bushing bag is very small and is loose inside the tire/wheel bag. Be extremely careful when removing the tires and wheels so that it does not get lost. It is also possible for the bushing bag to get wedged inside the front tires. If you do not see it, check the inside of each tire before removing it from the bag.**

Now take the bearing or bushing bag and remove the four bearings or bushings. Install one bearing or bushing into the center cavity on each side of the two front wheels. Now slide the wheels and tires (with bearings installed) onto the aluminum front axles.

In bag #7-1 you will find two #6222 4-40/5-40 black nylon self threading locknuts. Using a 1/4" nut driver or socket thread each nut onto a front axle until the excess end play on the front wheel is taken up by the nut. Make sure that the nylon nuts are not so tight that it will cause drag or binding of the front wheel bearings or bushings.



Fig. 207



○ #6222
4-40/5-40
nylon locknut

Fig. 208



○ #6906
3/8 x 3/16
unflanged bearing

Fig. 209

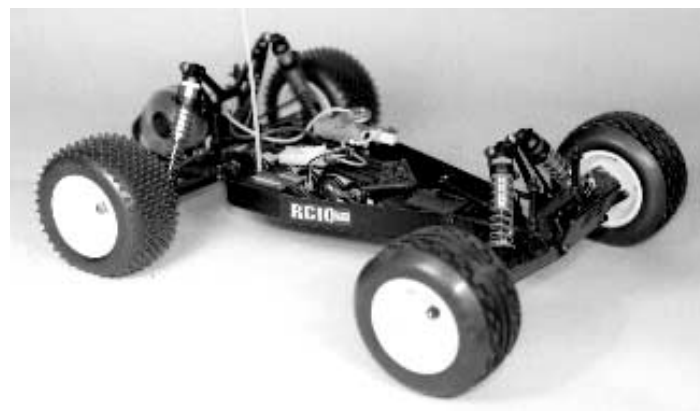

Your truck up to this point!

Fig. 209A

BODY PAINTING

□ **Fig. 210** in the kit box you will find the #6132 T2 clear Lexan Truck body and the #7198 T2 truck decal sheet. Fig. 210 shows a side view of the truck body after it has been trimmed, painted and decals added. The optional #7185 rear deck spoiler is also installed. This gives you an idea of how a finished body can look. You only have to follow this section if you need help in trimming and painting your body.



Fig. 210

TRIMMING THE BODY. The body can be painted before you cut out its holes; however, it's easier to install the body while it is still clear, because it will be easier to locate and cut the holes for the body mounts and antenna tube. Fig. 210 shows the side trim lines for the body. If this is your first attempt, only trim a little off at a time until it clears or fits. Cut out the body mounting holes. **Racers Tip:** Mark the areas with a marking pen that you want to trim, then use an X-acto® knife with a new blade to score the lines you just marked. You can then flex the body at the score line and peel off the part you want to remove. Be very careful around any sharp corners to prevent the body from tearing where it is not supposed to.

MASKING THE BODY. Make certain that the body is thoroughly clean. Because you will paint the inside of the body, you will mask the inside. Now mask the body off according to your paint scheme. Use automotive masking tape for the best results. Take the time to press all edges of the tape down with a Popsicle stick or your fingernail. To prevent overspray from getting on the outside of the body, put masking tape on the outside of the body at the body mount and antenna tube holes. When painting, you should apply the darkest colors first and the lightest last. This prevents the darker color from "ghosting" through the lighter color. So first mask the section to be painted white. The next color you mask is the next darker color nearest white, and so on.

PAINTING THE BODY. Now that you have the body fitted, it is time to paint it. The truck body is made of Lexan polycarbonate and is painted on the inside. There are two different ways to paint the body, by either brushing it on or spraying it on. You can find special Lexan or polycarbonate paints made to be brushed onto the body. Brushing the paint will always leave streaks in the paint job but will look satisfactory from a distance. If you want to spray the body, one of the best brands

of spray paints, for Lexan bodies, is *Pactra R/C Car Racing Finish*, available in most hobby shops.

Apply the paint in very thin coats, letting the paint dry between coats. **WARNING!** If the paint is sprayed on in heavy coats, the thinner in the paint stays liquid and attacks the Lexan, then the body becomes brittle and will crack easily.

Spray your darkest color first. Then peel off the next layer of masking tape and paint the next lighter color, and so on. If you make a mistake, the only product that we have found that can remove the paint without damaging the Lexan (if used properly) is Synthetic Reducer, which can be purchased through a automotive paint supply store.

□ **Fig. 211** In bag #7-5 you will find four #6332 body clips and four #7320 nylon body washers. The body clips are used to hold the body to the body mounts. You can use the body washers to protect the finish of the body by trimming them to fit the location you choose.

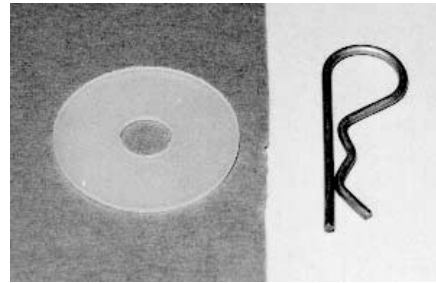
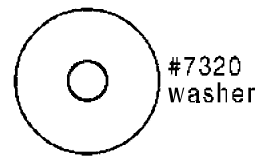

Fig. 211



#7320
washer



#6332
body clip

□ **Fig. 212** Here the front of the truck body is shown with the two body mounting holes drilled. It also shows some more of the decal details.



Fig. 212

□ **Fig. 213** Here we see the rear of the truck body installed on the chassis with the two body clips installed. You will also see the optional #7185 rear deck spoiler installed.

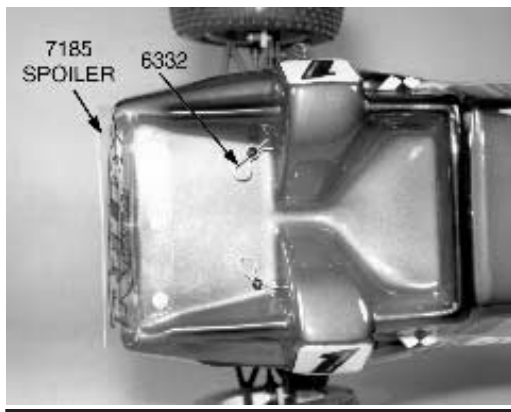

Fig. 213

Fig. 214 This is a photo of what your completed truck should look like. Now congratulate yourself, YOU DID FANTASTIC!!



Fig. 214

FINAL ADJUSTMENTS

BATTERY CHARGING. Charge your transmitter batteries if they are Ni-Cads. This will require an overnight charge. Next charge your battery pack according to your charger manufacturer's recommendations. Make sure all the speed control connections are according to the speed control manufacturers specifications. Then go on to the steps following in the order listed.

- Step 1** Turn the transmitter switch ON.
- Step 2** Make sure the motor is UNPLUGGED or UNSOLDERED.
- Step 3** Plug in your car batteries.
- Step 4** Turn the car switch ON (If you have an ESC this will be its on/off switch. If you have the mechanical throttle resistor this will be the on/off switch that came with your radio system).

Step 5 Move the right hand stick or turn the steering wheel to the right. See if the front wheels also turn to the right. If they turn to the left, you will have to move the steering servo reversing switch to the other position. Follow your radio system instructions on how to make this change. Recheck to make sure both the radio and front wheels turn to the right.

Step 6 When your wheels turn the correct way, take your hands off the steering wheel. Is the #9180 servo horn, on the steering servo, centered or in the straight up position? If it off just a little bit you can adjust it using your steering trim knob on the transmitter. If it is off quite a bit you will need to remove the servo horn from the servo. With the servo horn removed, center the trim control on the transmitter. Now reinstall the servo horn and see if you can adjust it straight up with the trim. If it still not able to trim to the straight up position, you will need to remove the servo horn and rotate its mounting position one spline on the output shaft. Now recheck and fine tune with your radio trim knob if necessary. Secure the servo horn with its mounting screw.

Step 7 Are your wheels now pointed straight forward? If not, start by checking the alignment of the left upper servo saver arm. It should be pointing straight across the chassis. If not then adjust the length of the tie-rod between the servo horn on the servo and the upper left servo saver arm. Now check the tire alignment again. If it still off you will have to look closely at the steering tie-rod turnbuckles. Adjust the length of both the right and left steering turnbuckles to correct the problem. After you have corrected this problem your tires and wheels will now be pointing straight ahead.

Step 8 Leave the transmitter switch ON. Now check the manual on the radio transmitter. Do you have a switch or adjustment to give the throttle control a 70/30 setting (this means you would use 70 percent of the throttle travel for forward and 30 percent for brakes).

If you have the mechanical speed control. Look at the throttle resistor and wiper arm on your throttle servo. (Do this from the drivers side so that the solder tabs on the resistor are facing away from you.) Now squeeze the throttle trigger or pull the left stick control back (this is normally the forward direction on the throttle stick). Does the wiper arm move to the left towards or under the bypass tab on the resistor? If it goes to the right then use the radio manual to move the servo reversing switch to the opposite position.

Now look at the face of the throttle resistor again. Just to the right of center you will see one wiper band that is wider than all the other bands. This is the neutral positioning bar. The wiper should be resting on this bar when the trigger is in its neutral position. If the wiper is only off a tiny amount you can use the throttle trim now to make the adjustment. If it is too far away to be adjusted by the throttle trim you will need to remove the wiper arm and rotate the wiper arm/servo horn assembly one or more

splines on the servo. Remount and then recheck the position of the wiper arm. Remember you can use the trim knob to fine tune the adjustment to get it correct. Next test the throttle by squeezing the trigger. Does the wiper arm go all the way over and under the throttle bypass tab? Everything is correct if you contact the bypass and the wiper arm does not come off the resistor on the brake side. **Note: If you have a radio system that does not have the 70/30 setting or switch but only the older 50/50 setting, it can still be made to work. This system just requires a little more time and effort to setup correctly. For this system you will have to have the wiper arm slightly to the left of the neutral band. You will use the throttle trim to adjust the wiper arm back over the neutral band. You will have to use almost all of the trim to accomplish this so that the wiper arm should not slip off the resistor when full brake is applied.**

If you have an electronic speed control (ESC) follow the speed control manufacturers' manual to make all settings and adjustments.

□ Step 9 Now turn the car switch OFF. A word of caution here. Have the truck sitting up on a block or work stand so the rear wheels cannot touch anything before you turn the car switch back on to check the speed control and motor operation. If you have not connected your motor plug during the testing of your speed control settings your motor into the speed control motor plug. Recheck the speed control settings with the motor now connected.

□ Step 10 When you are done setting the speed control (and probably playing with the throttle) turn the on/off switch OFF.

□ Step 11 *The transmitter switch must always be the FIRST SWITCH TURNED ON and THE LAST SWITCH TURNED OFF.*

YOUR TRUCK IS NOW READY TO RUN!

RC10T2 TRUCK MAINTENANCE

You will find your RC10T2 truck will give you many more hours of trouble-free operation. Even so you should periodically check all the moving parts: front and rear A-arms, steering blocks, steering linkage, shocks, and so on for wear, missing or loose parts. Also if any of the moving parts should get dirt in them (lets say in the arm hinge pins) then the truck's handling can suffer greatly. Replacing, tightening or cleaning of the parts in questions will greatly improve the performance of your truck.

MOTOR TROUBLESHOOTING. Because the truck is designed to run in the dirt it is possible the dirt can cause motor problems. This means that if you are having problems with your motor you will need to check this things first:

1) If the motor does not run at all you should check the

wiring connections first. Are all the wires and capacitors connected properly? Are all the solder connections in good shape? A bad solder connection will have dull finish or it will be rounded under the edges. (This means the solder has not properly bonded the parts together.) Pull on the wires to make sure that the connections are really solid.

2) A sticking brush could be caused by dirt or the brush braided wire getting caught or hung up on the brush holder. Either of these can prevent the brush from being axle to slide in and out inside the brush holder so that it is making contact with the commutator at all times. You can normally correct either problem by pulling the brush out of the brush holder a very small distance and then letting it snap back into the brush holder from the spring pressure of the brush spring. To prevent these problems in the future you should clean the brushes, holder and commutator. You should also re-route the brush wire over the top of the brush holder and then down into the spring slot on the right side of the brush holder (behind the spring). This way the brush wire cannot get caught or bent over the outer edge of the holder. Always keep in mind that the brushes need to be able to move freely in the brush holder.

3) To check for a shorted motor, you will want to remove the motor pinion from the motor. This will prevent the the vehicle from getting away from you or causing any damage. With a fully charged battery pack, turn on the radio transmitter followed by the car. Now give the car full throttle. Does the motor seem to reach full speed? If you are using a high revolution motor, it should sound like it is turning at a very high speed. Next, with the motor still running, place one finger on each side of the motor end bell so that one finger is contacting the positive side and the other is contacting the negative side. We are not trying to make electrical contact, we are just going to be looking for excessive heat. If the motor is shorted it will get extremely hot on one of both sides of the end bell in less than a minute. This means it will become hot enough to burn your finger at the end of the minute. If this is the case then you would need to send us the motor along with a copy of the purchase receipt (that shows the date of purchase) so that we can inspect the motor for defects. We will then test the motor to confirm your problem Upon confirmation of the defect we will send you a replacement motor. Following the above procedures will help to prevent your losing unnecessary time in being able to enjoy your new car kit.

MOTOR MAINTENANCE. After every 2 to 3 runs, remove the brushes from the holders and inspect the tips for wear and/or burning. If you notice any wear, replace the brush with a new pair. To inspect for a burnt tip, look at the side of the brush on the contact end. If it is a burnt blue color, then the lubricant in the brush has been burnt away; new brushes should be installed. These are important steps, for worn or burnt brushes can cause irreparable damage to the motor commutator. Changing brushes frequently will help maintain the life of your motor. For stock motors we recommend our #738 motor brush; for standard brush modified motors we recommend our #737 motor brush. And for laydown brush modified motors use our #760 motor brush. These are off road compounds, giving you excellent motor life and good power, but we do have other compounds for different applications. At the same interval you should carefully clean the motor. One

recommended method is to connect the motor to an old battery pack and, while the motor is running, spray a motor cleaner directly on the brush commutator area. Run the motor for approximately 15 seconds and apply the spray several times for 2 or 3 seconds. Disconnect the motor and spray again, making sure the run-off is clear and clean. If the run-off is still dirty, repeat the spraying action until clean. After completing the cleaning, apply a small amount of lightweight oil to the bushings or bearings for lubrication.

Never overgear your truck (large pinion and/or small spur gear). Overgearing can cause excessive heat and can damage or destroy your motor.

SCHOTTKY DIODE. A new development for motors and high frequency electronic speed controls is an add-on device called a Schottky diode. This diode is used by many speed control and motor manufacturers to improve the life and performance of both components. The diode is suppose to keep the braking MOSFETs cooler, improving their performance and making them more consistent. It also helps to reduce the amount of high voltage spikes from the motor that could reach your speed control; these spikes can contribute to premature failure. The reduced spikes also would increase the motor commutator life. Reedy sells a package of two replacement diodes, #745. **WARNING! Do not use Schottky diodes with reverse speed controls! The speed control will be damaged! Also, the diodes are polarized, so make sure that you hook positive to positive and negative to negative. If connected backwards, the truck will act like it has a shorted motor when the throttle is applied until the diode shorts out.** We also recommend the use of two diodes per motor when running a high power, low wind motor in a truck. Because of the high current the trucks can pull coming out of the corners due to high traction and large tires, it can be enough to overload a single diode.

A full line of Reedy stock and modified motors are listed in the truck catalog which should come with your kit. If you did not receive one in your kit you can call or write us, asking for the truck catalog, and we will happily send you one at no charge.

RADIO MAINTENANCE. Radio problems are normally the more common problems. But keep in mind that radio problems are caused by many sources to the radio system. Often it is the result of a combination of several factors which can include: motor noise, poor electrical connections, bad wiring layout, reversed or defective crystals, weak transmitter batteries, and so on. You can also have a very sensitive receiver. If your radio problems persist, one of the following tips may help:

Make sure your motor noise capacitors are properly installed. Most speed control manufacturers now recommend three .1 uFd capacitors per motor.

Make sure the brushes are free in their brush holders and that they are not chipped at the contact edges, which could cause arcing. Replace if necessary.

Try a different motor.

Try a different steering servo.

Try a different radio frequency, (the transmitter and receiver crystals can be damaged or broken).

Try mounting the receiver on its side with the crystal

up to get it away from the chassis. Also move it away from the side of the chassis.

Try moving the receiver up to the shock tower and mount the antenna on the rear bulkhead or shock tower.

Dress the radio wires well away from the power leads from the motor or battery.

Move the antenna wire away from the servo wires, which can generate a signal into the antenna wire.

The new, high frequency speed controls now also generate a low frequency signal which can cause interference with the receiver. Try to keep them at least two inches apart if possible.

If you have one of the new Schottky diodes, make sure that it is soldered on correctly. If soldered on backwards it will make the motor feel like it is shorted out.

Keep in mind that you can also run into outside interference at times, and the 75 mhz radio band will tend to be more susceptible to this problem than the 27 mhz band. Large metal objects such as chain link fences, light poles cars, vans, trailers or even florescent lights can occasionally cause local interference by momentarily blocking or reflecting a signal.

DIFFERENTIAL MAINTENANCE. You should rebuild the differential when the action gets somewhat "gritty" feeling. Usually cleaning and applying new lube per instructions will bring it back to new condition. The tungsten carbide diff balls (which are standard parts) should rarely need changing. Normally, as the parts seat, the diff will get smoother. If after carefully cleaning and relubing the diff parts the diff still feels gritty, the drive rings and thrust washers should be checked and possibly replaced. The parts wear in the following order: #6574 5/64" diff thrust balls, #6573 diff thrust washers, and then the #7666 diff drive ring. Refer to the diff section correctly reassemble the diff.

CLEANING YOUR TRUCK. You can clean your truck with many products Some may also be safe for cleaning electronics parts. Others may be safe for cleaning Lexan bodies. Electronics part cleaners will clean your car, motor and electronics. They are convenient and work very well, but can be expensive. There are also motor cleaning sprays which will clean your car and motor but are harmful to plastics like servo, receiver and speed control cases. Like the electronic cleaners, this works very well, but can cost a lot. To keep your maintenance costs down, you can clean the truck (not the motor) with normal household cleaners like 409, Fantastic, Simple Green or similar cleaners. These cleaners have water in them so they are not recommended for use on motors or electronics. Because of the water, you need to help prevent rust on the steel parts (axles, dog bones, diff outdrives, etc.). This can be accomplished by carefully drying the parts or spraying them with a product like WD40 to seal the surface of the part from moisture (after they have been cleaned) so they will not rust. The rust will not affect the performance of the vehicle only it's appearance. **WARNING! Most of these cleaners have chemicals in them that will affect the Lexan body.** The best way to clean your truck body is with warm water and a mild dish soap. Any other products will dry out the Lexan and make it easier for the body to crack.

Associated has recently released our new #711 Reedy Car Wash, which cleans both your car and Lexan body. It is biodegradable and Lexan safe but cannot be used to clean motors or electronics.

TUNING TIPS

You have several different adjustments on your RC10T, some of which can be used to tune the truck for different tracks or conditions.

DIFFERENTIAL ADJUSTMENT. Once the differential has been correctly adjusted, there should be no need to change it until rebuilding time. **(1)** Bottom out the diff spring and diff screw, **being careful to be extremely accurate when backing the screw out 1/8 to 1/4 turn.** **(2)** On a new or just-rebuilt differential, apply a small amount of throttle while holding one of the rear wheels stationary. Do this for about 15 seconds. This will correctly seat all of the differential parts. **(3)** Now recheck the diff adjustment by again following step 1 above.

TORQUE CLUTCH ADJUSTMENT. It is possible to over-tighten the torque clutch. If you do, you may damage the diff gears when landing off a jump. To prevent this, take your time when making clutch adjustments. On a new or just-rebuilt torque clutch, run the setting a little on the loose side for about one minute before readjusting to race settings. It is important to keep in mind that spinning the tires is not putting the power to the ground. With a fully charged battery you should only have about three to six inches of wheel spin (the tire actually spinning across the top of the surface) to get maximum advantage of the torque clutch. On a high traction surface you can adjust the torque clutch a little tighter than you would on a low traction surface. **Remember: the purpose of the clutch is to gain traction, not to break the tires loose.**

CASTER (fig. 215) describes the angle of the kingpin, in relation to the vertical plane, when looked at from the side of the car. As an example, 0° of caster puts the kingpin in a vertical line. Positive caster means the kingpin leans rearward at the top.

Caster has several effects; however, the easiest way to see its effects is to compare it to the casters on the bottom of a shopping cart. When the cart is pushed forward, any misalignment of the casters will cause a side load on the wheels and thus cause the wheels to realign in the direction of travel. Increasing the positive caster on your car will increase the steering turning into a corner and slightly decrease steering coming out of the corner. Reducing the positive caster will decrease the amount of steering you have going into a corner and increase the amount of steering you have in the middle of the corner and exiting the same corner. Associated makes positive caster blocks in increments of 5° starting at 5° and going through 30°. Your RC10T2 truck comes with 30° caster, front carrier blocks, which is what we

recommend for off road racing. The 30° of caster will give you good steering going into the corner but take away just enough steering coming out of the corner so that the truck will have less tendency to oversteer when accelerating out of the corner. The increased caster also gives you more stability on fast, bumpy track conditions.

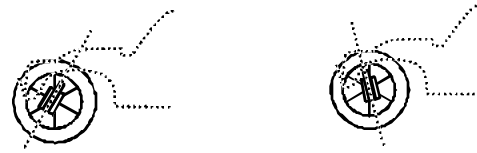

30° positive caster negative caster (not used)

Fig. 215

ADJUSTMENT:

Change front block carriers.

EFFECT:

Reducing caster: decreases steering into corners, increases steering at middle and end of corners.

Increasing caster: Increased steering at beginning of corners, more understeer out of corners.

RECOMMENDED: 30° caster.

POSITIVE CASTER OPTIONS: #6211, Front block carrier, 5° caster. #6212, Front block carrier, 10° caster. #6213, Front block carrier, 15° caster. #6214, Front block carrier, 20° caster. #6215, Front block carrier, 25° caster. #6210, Front block carrier, 30° caster, included in kit.

CAMBER is a word describing the angle at which the tire and wheel rides relative to the ground when looked at from the front or back (fig. 216). This is one of the most important adjustments on the truck. Negative camber means that the tire leans inward at the top, putting it closer to the centerline of the truck than the bottom of the tire. Positive camber means just the opposite, the top of the tire is further away from the centerline of the truck than the bottom of the tire.

Excessive negative camber will take away traction but increase stability. Positive camber will also take away traction but decrease stability. A tire's maximum traction is achieved when it is perpendicular to the ground (straight up and down). For the rear tires this will cause understeering in most conditions and possibly traction rolling in high traction conditions. We suggest a starting setting of 2° of negative camber for both front and rear. If you want to add a little more steering, reduce front camber to 1° negative or even 0°. Keep in mind that using little or 0° of camber will cause the truck to slide unpredictably. Try to use at least 1 to 2° negative camber at all times. This can be adjusted by turning the upper control rod turnbuckles (front or rear) in the appropriate direction.

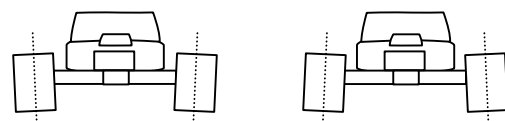

positive camber

negative camber

Fig. 216

ADJUSTMENT:

Turn upper control rod turnbuckles.

EFFECT:

Negative (more than 2°): less traction, more stability.

Positive: less traction, less stability.

0° to 2°: maximum traction.

RECOMMENDED: 2° negative camber front and rear.

FRONT TOE-IN AND TOE OUT. (Fig. 217). Adding toe-in to the front tires helps stabilize your truck under acceleration, but at the same time it removes a small amount of turn-in steering. Toe-out will add turn-in steering, but will reduce stability under acceleration or through the bumps. Both toe-in and toe-out will scrub speed, so try to use as little as possible of either.

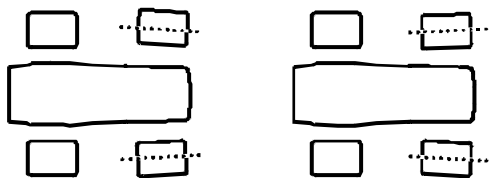

front toe-in

front toe-out

Fig. 217

ADJUSTMENT:

Front toe-in and toe-out can be changed by adjusting the steering tie-rod turnbuckles.

EFFECT:

Front toe-in: improves stability during acceleration; less turn-in steering.

Front toe-out: causes instability during acceleration and through bumps; more turn-in steering.

RECOMMENDED:

Starting setting of 0° of front toe-in. Our Team almost never uses front toe-out.

REAR TOE-IN. Rear toe-in affects steering and rear traction. Decreasing rear toe-in increases steering, but decreases rear traction. Your new RC10T2 comes with 3° toe-in (per side) rear suspension mounts and 0° toe-in rear hub carriers. To change the rear toe-in you must replace the rear suspension mounts and hub carriers. The standard mounts and hub carriers on your truck will work for most tracks, but, if you are running on an **extremely** rough track, you can relocate the rear toe-in from the mount to the rear hub carrier to help the truck handle under these conditions. Maximum recommended rear toe-in for the truck is 4.5° per side.

ADJUSTMENT:

Changing rear suspension mount and hub carriers.

EFFECT:

Rear toe-in, increased: reduces speed; less steering, more rear traction.

Rear toe-in, decreased: increases speed; more steering, less traction.

OPTIONAL ADJUSTMENT:

For extremely rough track setup. Change the 3° rear mount to a 0° rear mount and change the 0° rear hub carrier to a 3° rear hub carrier. Makes the truck a little easier to drive over the rougher track sections.

OPTIONS:

Rear suspension mounts:

#7364 0° toe-in per side

#6360 1 1/2° toe-in per side

#7363 3° toe-in per side (included in kit.)

Rear hub carriers

#7365 0° toe-in per side (included in kit)

#7358 3° toe-in per side

WHEELBASE ADJUSTMENT. The RC10T2 wheelbase can be changed easily to allow further fine tuning of your truck for different track conditions. This can be accomplished by moving the #6466 1/8" plastic spacer on the rear outer hinge pin (next to the rear hub carrier) to the other side of the rear hub carrier (fig. 218). The standard position places the spacer behind the rear hub carrier. This is the shortest wheelbase position and gives the most rear traction and a slight amount of understeer (push). Moving the spacer in front of the rear hub carrier will lengthen the wheelbase and at the same time increase steering entering and exiting corners. This position will also improve handling on bumpy track conditions.

These adjustments may seem backwards, but you are shifting a large amount of weight front to rear by moving the rear axle position. The actual difference in wheelbase length is a change you can really feel. As an optional fine tuning setup you can replace the 1/8" spacer with two #6466 1/16" spacers, placing one on each side for a less significant change. (The Associated #6466 kit contains 1/32", 1/16" and 1/8" spacers.)

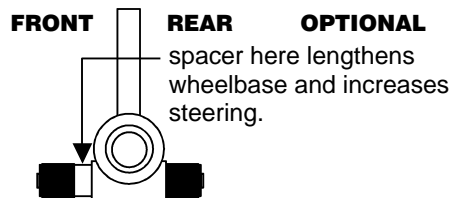
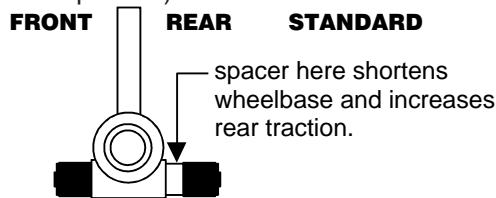

Fig. 218

MOTOR GEARING

You can get the most from your motor with the correct gearing.

STOCK. A recommended starting 'final drive gear ratio' for trucks with stock motors and six cells will be between 9.83:1 and 11.91:1. Your choice of gear ratios will be further influenced, however, by the type of stock motor

and factors such as your track's length, traction and composition; tight or open track; and your truck's rear tire diameter. A basic 24° stock motor would start around at the low end (9.83:1; spur 87/pinion 23) of the scale while a 36° to 40° short stack stock motor would start at the high end (11.91:1; spur 87/pinion 19) of the gearing scale.

MODIFIED. For modified motors we have included a starting gear ratio chart for the truck. This chart is based on using seven cells and four inch diameter tires. If you are running a six cell pack, then you will normally add one or two teeth to the recommended pinion size for your setup. The formulas that follow can help you gear correctly for your motor and help you match a recommended gear ratio given to you. We recommend starting with a 14 turn modified motor.

Recommended starting modified gear ratios:

	<i>spur/pinion</i>	
17 turn	87/21	10.77:1
16 turn	87/20	11.31:1
15 turn	87/19	11.91:1
14 turn	87/18	12.56:1
13 turn	87/17	13.30:1
12 turn	87/16	14.13:1
11 turn	87/15	15.08:1

Examples:

Converting a buggy gear ratio to truck ratio. If you have a recommended gear ratio for a particular motor, but the setup given was for a buggy, you can convert the final drive numbers to correct for the differences in tire diameter so that the motor will see the same load in the truck as it would see in the buggy. The average difference between buggy and truck tires is an increase in 33%. Your formula is as follows:

$$9.5 \times 133\% = 12.635 = 12.64:1$$

How to determine the final drive ratio based on actual spur gear and pinion size. Spur gear = 87, pinion = 20

$$(87 / 20) = 4.35 \times 2.60 = 11.31 = 11.31:1$$

How to determine starting pinion size based on recommended final drive ratio and chosen spur gear size. Spur gear = 87, final drive ratio = 13.50:1

$$(87 / 13.5) = 6.444 \times 2.6 = 16.754 = 16.75 = 17 \text{ (always round to nearest whole number)}$$

BATTERY CHARGING

It is important to understand the characteristics of the battery pack in your truck. How you charge and use it will greatly affect both its performance and its life. With proper care your pack will perform well for many hundreds of cycles.

The ROAR legal battery for use with your truck is composed of six or seven "sub-C" size cells with a rated

capacity of between 1.2-1.8 amperes for one hour, or 2.4 amperes for 1/2 hour, etc. This charge capacity is the same regardless of the number of cells in the pack because the cells are connected in series and the same current passes through each one.

CHARGER. A good quality automatic charger will last longer than an economy unit, so please do not cut yourself short here by trying to save a couple of dollars. Any good name brand charger will do the job correctly. **Associated recommends a peak detection charger as opposed to the timer charger.** Timer chargers increase the chance of making a mistake when charging the battery. This also increases the chance of damaging the battery pack. Peak detection chargers have an internal circuit that monitors the voltage and charge rate of the battery pack. When the pack is fully charged, the voltage will begin to decrease and a peak charger will detect this and either turn the charger off, or down to a trickle charge. Some chargers have even more sophisticated features that make charging less time-consuming. The better chargers like this can easily handle the abuse of heavy back-to-back type charging that is common when racing or playing for a long time. The choice of a DC only or an AC/DC charger should be based on personal needs (where you will be using your truck, etc.) and usage.

OVERCHARGE. There is no way to make a Ni-Cd cell accept more charge than it is designed to hold. This means that as the cell approaches a fully charged condition, the portion of charging current not being stored becomes heat and pressure. If charging continues after the cell is fully charged, all of the current is converted to heat and pressure—about 40 watts worth, or the equivalent of the heat produced by an average soldering iron. High temperature and pressure is damaging to the cells, so overcharging must be avoided.

Ni-Cd cells have a built-in process for recombining the accumulated gas (actually oxygen) produced by overcharge, but the process produces heat and takes a lot of time. If you overcharge your battery and it seems to take a long time to cool down, it's because this pressure reducing reaction is taking place. Once the gas is recombined the temperature drops.

HOW TO TELL WHEN YOUR CELLS ARE CHARGED

One of the problems with Ni-Cds is their inherent voltage stability; the voltage of a fully charged cell is not much different from one that's just about dead. For that reason several indicators, along with some common sense, are needed in order to get the most out of your battery. The following is a list of indicators you can use to detect full charge.

SLOW CHARGE METHOD. Slow or "overnight" charging is a method you are not likely to use often, but it is a good way to bring the pack to absolutely full charge. However, the output voltage of a slow charged pack is slightly lower.

The charging current must be between 0.05 and 0.12 amperes. If less current, the pack will never reach full charge; any more and the pack will overheat. The time required to reach full charge ranges from 15 to 40 hours, depending on the current used. The charger can be left on for a much longer time without harming the cells; however, the output voltage of the pack will be temporarily lowered by an extremely long overcharge. The voltage returns to normal after a discharge-charge cycle.

These next two tips are for the benefit of serious racers. If you're just out having fun, don't worry about them.

FULL DISCHARGE. Ni-Cd packs perform best if they are COMPLETELY discharged before they are charged. If you are involved in racing, you will have to do this if you expect to win any races! Discharge for at least an hour (preferably overnight with a clip-on resistor) before charging.

TOPPING-UP can give you a little extra voltage at the beginning of a race, as long as you don't overdo it. Put the last minute or two of charge into your pack just before the race starts.

GOOD LUCK IN YOUR RACING!

CAUTION

Ni-cad batteries are susceptible to damage when overcharged at a high rate, and can release caustic chemicals if the overcharge is severe.

Do not stall the motor under power. If the truck stops suddenly on the track, or fails to move forward when you attempt to accelerate, push the throttle control on your transmitter to the brake position immediately and attend to the truck. A small rock can stall the gears, and if the throttle is left in the on position the result can be a burned out motor (or electronic speed control unit).

If you run your truck to the point where more than one cell in the pack is completely discharged, it is possible to lose radio control of the truck before the drive motor stops completely. For this reason you should not operate your truck in an area where it could be harmed or cause harm, such as near a busy roadway or a pool of water. Usually radio control will be regained as soon as you pick up the truck and the motor is allowed to free-run. If you still don't have control, then you should unplug the motor.

When you stop running your truck, turn off the radio **at the truck first before** turning off the transmitter.

A burned-out or shorted motor can make the truck appear to have radio problems. If the truck slows down suddenly and the radio acts erratically even with a full battery charge, then the cause is probably the motor. Check the range of the radio with the motor unplugged. A shorted motor will draw extremely high current even under no-load conditions.

SAVE THIS BOOKLET!

MORE THAN AN INSTRUCTION MANUAL, IT'S ALSO A HANDY, PICTORIAL SUPPLEMENT TO TEAM ASSOCIATED'S RC10T2 CATALOG.

REFER TO THIS MANUAL FOR PART NUMBER AND NAME WHEN ORDERING.