

E
MAXX



E-Maxx Owner's Manual

**Model
3906**

TRAXXAS

Traxxas
Corporate Headquarters
1100 Klein Road
Plano, Texas 75074
Phone: 972-265-8000
Toll-free 1-888-TRAXXAS

Traxxas U.K.
P.O. Box 1128
Winterbourne, Bristol BS17-2SH
England
Phone: 44.117.956.1002

Internet
www.Traxxas.com
www.MaxxTrucks.com
E-mail: support@Traxxas.com

Entire contents ©2002 Traxxas. Traxxas, E-Maxx, TQ-3, and ProGraphix are trademarks or registered trademarks of Traxxas Corporation. Other brand names and marks are the property of their respective holders and are used only for purposes of identification. No part of this manual may be reproduced or distributed in print or electronic media without the express written permission of Traxxas.

020823

Introduction

Thank you for purchasing the Traxxas E-Maxx, and congratulations on owning what we believe is the most advanced, most powerful electric monster truck available. This sophisticated truck incorporates many special features including 4 wheel drive, shift on the fly two-speed transmission, twin Titan 550 motors, and the powerful EVX electronic speed control. This manual contains the instructions you will need to operate, and maintain your E-Maxx so that you can enjoy it for years to come.

Please read all of the Operating Instructions and Precautions before attempting to drive the E-Maxx. Even if you are an experienced R/C enthusiast, continue reading to learn about the best ways to use E-Maxx's unique features. Also, please pay special attention to the mechanical and safety precautions outlined in the manual to avoid any chance of injury to you or damage to the truck.



- 4 Before You Proceed
- 5 Safety Precautions
- 6 Tools, Supplies and Required Equipment
- 7 Anatomy of the E-Maxx
- 8 Quick Start: Getting Up to Speed
- 9 Gluing the Tires
- 10 Decorating Your E-Maxx
- 11 The Traxxas TQ-3 Radio System
- 21 Driving the E-Maxx
- 22 Adjusting Your E-Maxx
- 28 Maintaining and Storing Your E-Maxx
- 29 Trouble Shooting Your E-Maxx
- 30 Index

Before You Proceed

Carefully read and follow all instructions in this and any accompanying materials to prevent serious damage to your E-Maxx. Failure to follow these instructions will be considered abuse and/or neglect.

Before running your E-Maxx, look over this entire manual, and examine the truck carefully. If for some reason you decide the E-Maxx is not what you wanted, then do not continue any further. **Your hobby dealer absolutely cannot accept an E-Maxx for return or exchange after it has been run.**

Warnings, helpful hints, and cross-references

Throughout this manual, you'll notice warnings and helpful hints, identified by the icons below. Be sure to read them!



An important warning about personal safety or avoiding damage to your E-Maxx and related components.



Special advice from Traxxas to make things easier and more fun.



Refers you to a page with a related topic.

Support

If you have any questions about your E-Maxx or its operation, call the Traxxas Technical Support line toll-free at: 1-888-TRAXXAS (1-888-872-9927)

Technical support is available Monday through Friday from 8:30 am to 9:00pm central time. Technical assistance is also available at www.Traxxas.com. You may also e-mail customer support with your question at support@Traxxas.com. Join thousands of Traxxas R/C enthusiasts in our online community at www.ReadyToRun.org

Traxxas offers a full-service, on-site repair facility to handle any of your Traxxas service needs. Maintenance and replacement parts may be purchased directly from Traxxas, or you can save shipping and handling costs by purchasing them from your local hobby dealer.

Safety Precautions

All of us at Traxxas want you to safely enjoy your new E-Maxx. Operate your E-Maxx sensibly and with care, and it will be exciting, safe, and fun for you and those around you. Failure to operate your E-Maxx in a safe and responsible manner may result in property damage and serious injury. The precautions outlined in this manual should be strictly followed to help ensure safe operation. You alone must see that the instructions are followed and the precautions are adhered to.

Important Points to Remember

- ▶ The truck is not intended for use on public roads or congested areas where its operation can conflict with or disrupt pedestrian or vehicular traffic.
- ▶ Never, under any circumstances, operate the truck in crowds of people. The truck is very fast and could cause injury if allowed to collide with anyone.
- ▶ Because the truck is controlled by radio, it is subject to radio interference from many sources that are beyond your control. Since radio interference can cause momentary losses of radio control, always allow a safety margin in all directions around the model in order to prevent collisions.
- ▶ The motors, batteries, and speed control can become hot during use. Be careful to avoid getting burned.
- ▶ Don't operate your E-Maxx at night, or anytime your line of sight to the model may be obstructed or impaired in any way.
- ▶ **Most importantly, use good common sense at all times.**





All instructions and precautions outlined in this manual should be strictly followed to ensure safe operation of your E-Maxx.



The E-Maxx is not intended for use by those under 16 years of age without the supervision of a responsible and knowledgeable adult.

Tools, Supplies, and Required Equipment

 For more info on batteries, see *Use the Right Batteries* on page 13.







 A peak-detecting charger is recommended for best performance and longest battery life. For more information, see *Use the Right Charger* on page 14.

 **7-Cell Operation:** Your E-Maxx can use (2) 8.4-Volt 7-cell battery packs. Using 7-cell batteries will allow the E-Maxx to achieve 30+ MPH speeds. The packs must be specially made to fit the E-Maxx chassis. Go to www.Traxxas.com/7cell to learn how to make 7-cell battery packs for the E-Maxx.



Your E-Maxx comes with a set of specialty metric tools. You'll need to purchase other items, available from your hobby dealer, to operate and maintain your model.

Supplied Tools







Your E-Maxx comes with these specialty metric tools:

-  1.5mm hex wrench
-  2.0mm hex wrench
-  Universal (glow plug) wrench
-  Turnbuckle wrenches
-  U-Joint wrench
-  4-way wrench

Batteries

-  8 AA alkaline batteries for the radio system
-  Two 7.2-volt NiCad battery packs
-  NiCad battery charger

Other Required Tools and Supplies

-  Thin, hobby-quality cyanoacrylate instant tire glue (often called CA glue)
-  Safety glasses
-  #2 Phillips screwdriver
-  #1 Phillips screwdriver
-  Small flat-blade screwdriver (1/8 inch blade)
-  Hobby knife

Anatomy of the E-Maxx

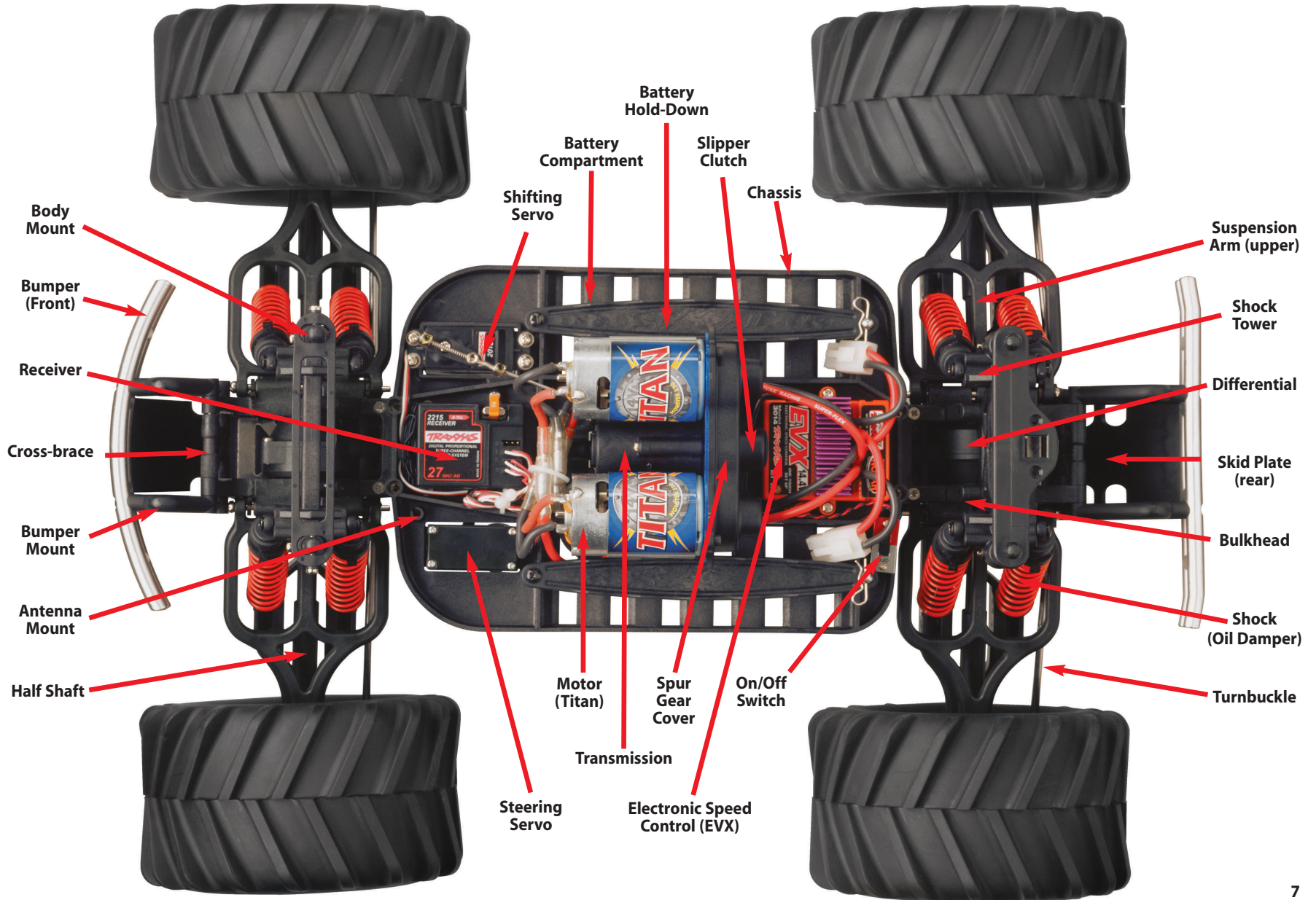

Quick Start: Getting up to Speed



The Quick Start Guide is not intended to replace the full operating instructions available in this manual. Please read this entire manual for complete instructions on the proper use and maintenance of your E-Maxx.



The following guide is an overview of the procedures for getting your E-Maxx running. Refer to the pages indicated for details on each step. Look for the Quick Start logo on the bottom corners of Quick Start pages.

- 1. Charge the battery packs • See sidebar, page 14**
The E-Maxx requires two fully charged 7.2-volt battery packs (not included).
- 2. Glue the tires • See page 9**
Glue the tires to the rims to prevent the rims from spinning inside the tires.
- 3. Install the antenna • See page 15**
Install the antenna mast in the E-Maxx.
- 4. Install batteries in the transmitter • See page 13**
The TQ-3 transmitter requires 8 AA alkaline batteries.
- 5. Install battery packs in the model • See page 14**
- 6. Turn on the radio system • See page 18**
Make a habit of turning the transmitter on first, and off last.
- 7. Check servo operation • See page 19**
Make sure the throttle, steering, and shifting servos are working correctly.
- 8. Range test the radio system • See page 20**
Follow this procedure to make sure your radio system works properly at a distance and that there is no interference from outside sources.
- 9. Decal and Install the body • See page 10**
- 10. Drive your E-Maxx • See page 21**
Driving tips and adjustments for your E-Maxx
- 11. Maintaining your E-Maxx • See page 28**
Follow these critical steps to maintain the performance of your E-Maxx and keep it in excellent running condition.

Gluing The Tires

The tires on your E-Maxx must be glued to the rims using CA tire glue to prevent the rims from spinning inside the tires. You can glue the tires without removing the wheels from the truck. For clarity, these instructions show the process with the wheels removed.

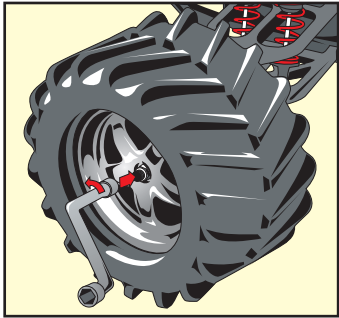

1. Remove a wheel from the E-Maxx using the larger (8mm) end of the glow plug (universal) wrench.

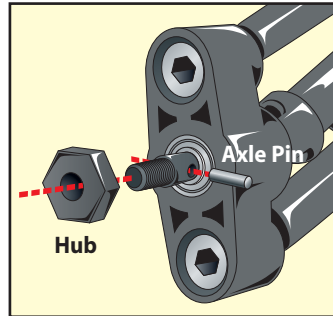

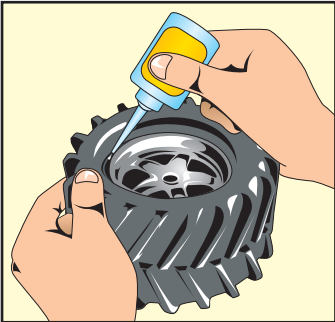

4. Reinstall the wheels, making sure none of the axle pins have fallen out from behind the hex hubs.



2. Use your thumb to push the side of the tire away from the rim. Place one or two drops of CA glue into the opening and release the tire. Capillary action will draw the glue around the bead of the tire.

3. Repeat step two at four or five points around the rim, until the tire is completely secured to the rim. Turn the rim over and repeat the process for the inside of the rim/tire. Repeat for the other 3 wheels.

 Always wear safety glasses to prevent glue from splattering into your eyes.

 The acetone in fingernail polish remover will remove excess glue from your fingers.

Decorating Your E-Maxx

Applying The Decals

The ProGraphix painted body is covered with a protective film for shipping. You must remove this film before applying any decals.

To remove the film, lift a corner of the film and carefully pull it off the body in one continuous piece.

Your E-Maxx decals are die-cut for easy removal. Use a hobby knife to lift the corner of a decal and lift it from the backing.

Carefully position the decal over the desired location and press one side on the body. Pull the decal tight and use a finger to gradually smooth out any air bubbles as you apply the decal.

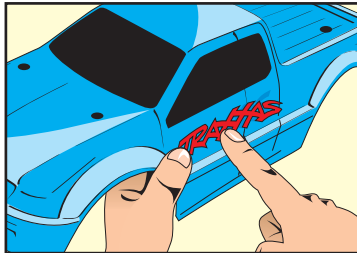
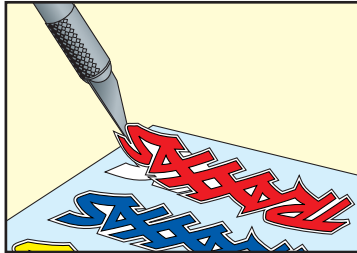
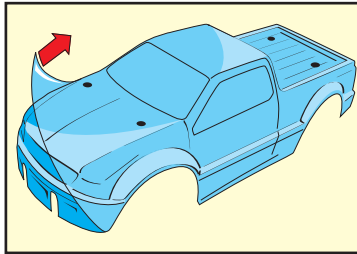

Look at the photos on the box for typical decal placement.

The Traxxas TQ-3 Radio System

Your E-Maxx (model 3906) is equipped with the TQ-3 Radio System. The TQ-3 is a 3-channel system that provides high-power output up to a quarter mile and control for up to three servos. The E-Maxx uses two servos and an electronic speed control.

TQ-3 Transmitter



E-Maxx Wiring Diagram

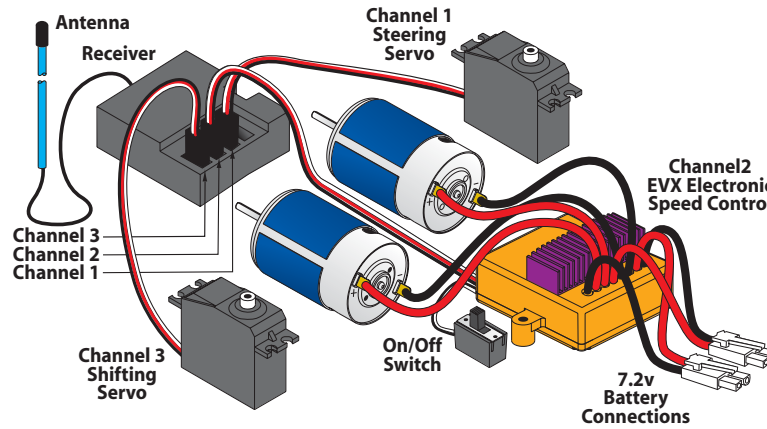

Radio System Terminology

Please take a moment to familiarize yourself with these radio-system terms. They will be used throughout this manual.

Channel - The 27 MHz frequency band is divided into 6 channels so that up to six models can be operated simultaneously. Each channel is referred to by its flag color and channel number, as shown below.

Channel	Frequency Band	Flag Color	Traxxas Part No.
1	26.995	Brown	2031
2	27.045	Red	2032
3	27.095	Orange	2033
4	27.145	Yellow	2034
5	27.195	Green	2035
6	27.255	Blue	2036

Clearing your frequency - A routine, verbal check to make sure nobody else in your area is operating on the same channel. Always clear your frequency by calling out your channel number before operating your model. Wait or move to another area if your channel is already being used.

Crystal (X-tal) - The plug-in device that determines which channel the radio system will operate on. For each channel, there are two crystals, one for the receiver and one for the transmitter. Of those two crystals, the one marked with the lower number (.455 MHz lower) must be inserted into the receiver.

ESC (Electronic Speed Control) - An electronic speed control is the electronic motor control inside the model. An ESC uses MOSFET power transistors to provide precise, digital proportional throttle and braking control. Electronic speed controls use power more efficiently than mechanical speed

controls so that the batteries run longer. An electronic speed control also has circuitry that prevents loss of steering and throttle control as the batteries lose their charge.

Frequency band - The radio frequency used by the transmitter to send signals to your E-Maxx. All Traxxas RTR models operate on a 27 MHz frequency band.

Neutral position - The standing position that the servos seek when the transmitter controls are at the neutral setting.

NiCad - Refers to rechargeable, nickel-cadmium batteries. The most economical choice, since they may be recharged up to 500 times.

Receiver - The radio unit inside your E-Maxx that receives signals from the transmitter and relays them to the servos.

Servos - Small motor units in your E-Maxx that operate the shifting and steering mechanisms.

Three-channel radio system - The TQ-3 radio system, consisting of the receiver, the transmitter, and the servos. The system uses three channels: one to operate the steering, one to operate the ESC (throttle/brakes) and a third channel to control shifting.

Transmitter - The hand-held radio unit that sends throttle and steering instructions to your E-Maxx.

Trim - The fine-tuning adjustment of the neutral position of the servos, made by turning the throttle and steering trim knobs on the face of the transmitter.

BEC (Battery Eliminator Circuit) - The BEC can either be in the receiver or in the ESC. This circuit allows the receiver and servos to be powered by the main battery pack in an electric model. This eliminates the need to carry a separate pack of 4 AA batteries to power the radio equipment.

Smart Braking™ - Trademark name for technology developed by Novak Electronics that allows the same throttle trigger motion to control both braking and reverse functions. The EVX speed control senses how fast the model is running and applies the brakes to slow the model. Once stopped, reverse is applied.

Thermal Shutdown Protection – Temperature sensing electronics are used in the ESC to detect overloading and overheating of the transistor circuitry. If excessive temperature is detected, the unit automatically shuts down to prevent damage to the electronics.

One-Touch Setup™ - Novak Electronics trademark name for circuitry inside the EVX electronic speed control that allows it to adjust to the transmitter settings by pressing a button on the speed control and operating the transmitter controls (see page 26 for instructions).

Polar Drive Circuitry™ - Trademark name for technology developed by Novak Electronics that allows the EVX speed control to operate more efficiently at part throttle, and recharge the batteries during braking (regenerative braking). This results in cooler running, increased power handling, and longer run times.

Installing Transmitter Batteries

Your TQ-3 transmitter uses 8 AA batteries. The battery compartment is located at the base of the transmitter.

1. Remove the battery compartment door by pressing the tab and lifting the door up.

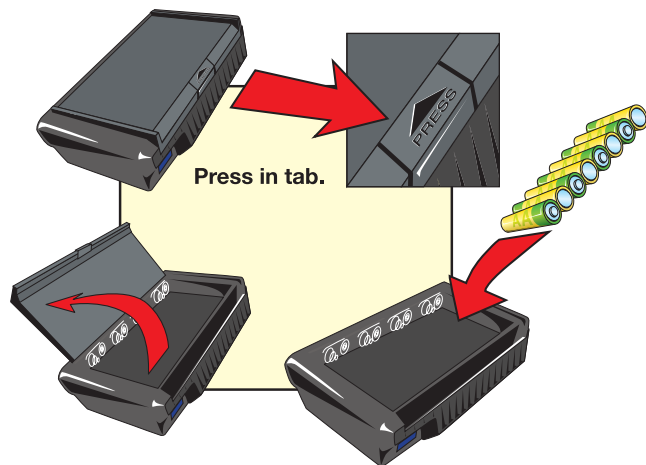

2. Install the batteries in the correct orientation as indicated in the battery compartment.
3. Reinstall the battery door and snap it closed.
4. Turn on the transmitter and check the power indicator for a solid red light.

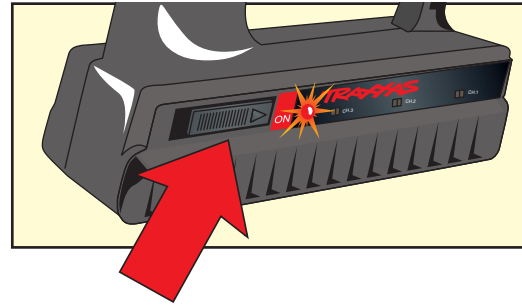

If the power indicator light flashes, then the transmitter batteries are weak, discharged or possibly installed incorrectly. Replace with new or freshly charged batteries. The power indicator light does not indicate the charge level of the receiver batteries in the model.

Use the Right Batteries

Your transmitter uses AA batteries. Use new alkaline batteries, or rechargeable batteries such as NiCad or Ni-MH (nickel-metal hydride) batteries in your transmitter. Make sure rechargeable batteries are fully charged according to the manufacturer's instructions.

If you use rechargeable batteries in your transmitter, be aware that when they begin to lose their charge, they lose power much more quickly than regular alkaline batteries.

Caution: Discontinue running your E-Maxx at the first sign of weak batteries (flashing red light) to avoid losing control.



If the power indicator doesn't light red, check the polarity of the batteries. Check rechargeable batteries for a full charge.



Use the Right Charger

The most convenient type of charger is an AC peak-detecting charger that plugs directly into an AC wall outlet. It contains special peak-detection circuitry that automatically shuts the charger off when the battery is fully charged.

If you're using a 15-minute timed charger, always fully discharge the battery pack before each charge. Some high mAh battery packs (1500 mAh or higher) require more than the standard 15 minutes of charge time. If the battery pack is cold after 15 minutes of charging, add another 5 minutes of charge time. Closely monitor the battery pack and stop charging it when it begins to feel warm to the touch. Never leave a battery charging unattended. Always follow charger manufacturer's instructions.



If the radio system doesn't appear to work when the transmitter and model switches are turned on, check for correct battery installation.

Installing Battery Packs

The E-Maxx requires two fully charged 7.2 volt NiCd or NiMH battery packs. **Do not run the E-Maxx with just one battery.** These batteries are not included with the model. You can use either side-by-side racing style packs or the more common stick packs. The battery compartments on the E-Maxx are designed to handle both. The E-Maxx's run time is greatly affected by the milliamp hour (mAh) rating of the batteries. A 3000 mAh battery pack will theoretically run twice as long as a 1500 mAh sport pack. Follow the charger manufacturer's directions for charging and caring for your battery packs.

The battery compartments are configured for stick packs from the factory. If you are using side-by-side racing packs, then you will need to reconfigure the battery hold downs as shown:

Stick packs

1. Remove the body clip securing the battery hold down. Lift the end of the hold down and swing it out.
2. Slide the battery pack in place. Swing the hold down back in and over the post.
3. Secure it with the body clip. Use the upper hole in the post. Repeat for the other pack.

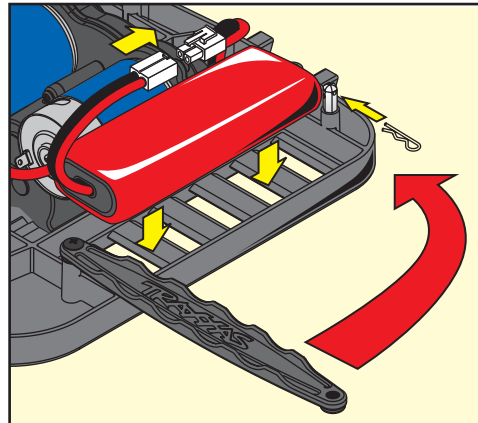

Using stick packs

Side-by-side packs

When using side-by-side packs, the battery retainer must be completely removed and flipped over.

1. Remove the shoulder screw which acts as the hinge for the battery retainer. Replace the shoulder screw with the supplied metal post (found in your instruction manual packet).
2. Install the batteries in the compartment and then place the battery hold down over the posts with the flat side facing up.
3. Secure the battery hold down with body clips in the lower holes in the posts.

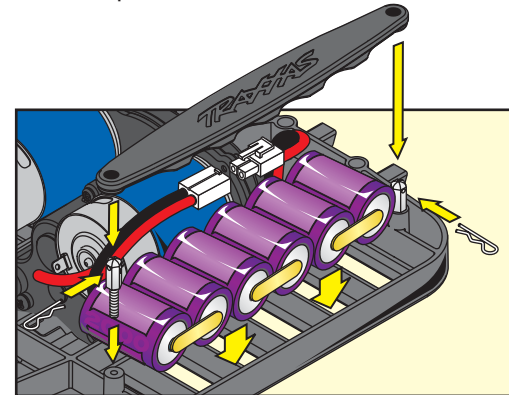

Using side-by-side packs

See page 25 for information about installing 7-cell (8.4 volt) battery packs in the E-Maxx.

Setting Up the Antenna

You must install the antenna mast (tube) before you operate your E-Maxx. You'll find the plastic antenna tube and tip in the bag with your manuals and documentation.

1. Locate the black antenna wire that exits the receiver. The E-Maxx receiver is mounted in the front of the chassis.
2. Pull the wire straight with your fingers and then insert the end of the wire into one end of the antenna tube. Push the wire all the way through the antenna tube.
3. Pull the remaining wire through the antenna tube, and then insert the base of the antenna tube into the molded post on the chassis.
4. Fold the remaining antenna wire over the top of the tube and secure it with the antenna tip.
5. On the transmitter, always fully extend the telescoping antenna when running your E-Maxx. Make a habit of holding the transmitter so that the antenna points straight up.

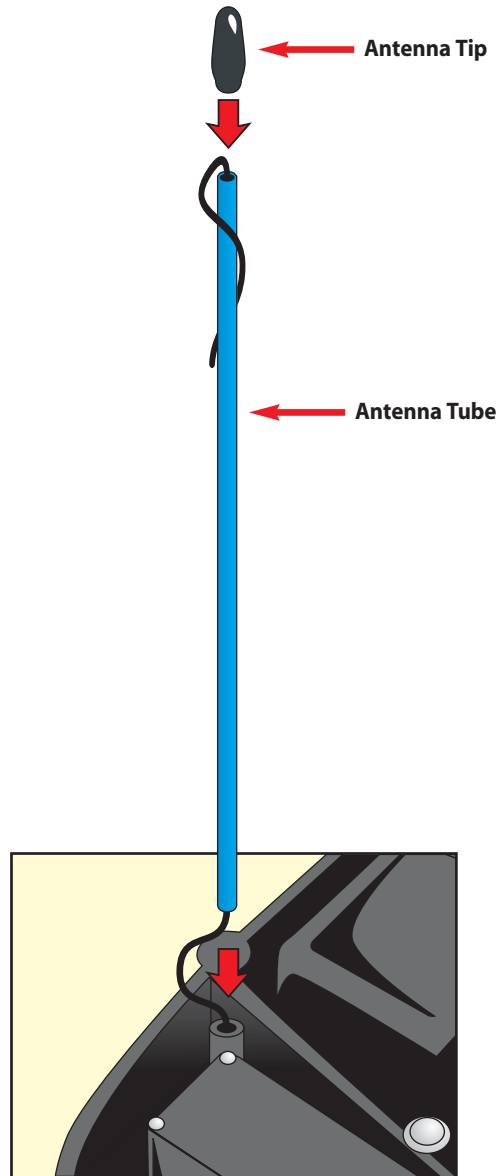

 Spray a little window cleaner on the antenna wire to make it easier to push through the antenna tube.

 Don't shorten the length of the antenna wire. Its length is tuned to the frequency band; cutting it could severely shorten the radio system's range.

 Don't push the transmitter antenna down from the top. Pull it down from the bottom, one segment at a time, to prevent binding and kinking the antenna mast.

TQ-3 Radio System Adjustments

In addition to the electronic throttle and steering trim controls, your radio system features throttle neutral adjustment and servo reversing switches.

Throttle Neutral Adjustment

The throttle neutral adjustment is located on the transmitter face and controls the forward/brake travel of the throttle trigger. Change the adjustment by pressing the button and sliding it to the desired position. There are two settings available:

- ▶ 50/50: Allows equal travel for both acceleration and braking.
- ▶ 70/30: Allows more throttle travel (70%) and less brake travel (30%).

50/50 is the recommended setting for the E-Maxx.

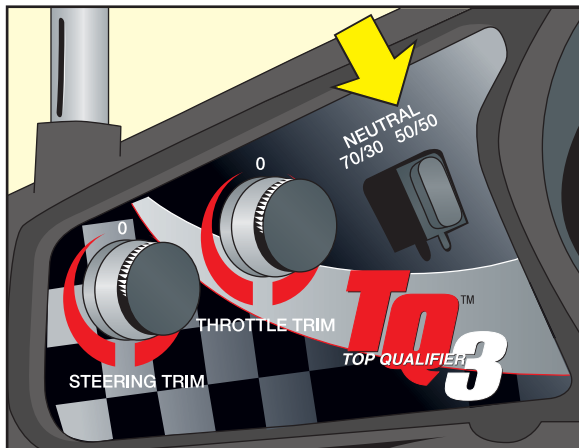

Electronic Throttle Trim

The electronic throttle trim located on the face of the transmitter adjusts the neutral (center) point of the throttle trigger signal to the electronic speed control. This control has been preset for you at the factory. If the motors run when the truck (EVX) is switched on, then turn the throttle trim control on the transmitter until the wheels stop. If anything more than a slight adjustment of the throttle trim control is required, then you should readjust your speed control. Refer to the Adjustments section on pages 25 and 26.

Electronic Steering Trim

The electronic steering trim located on the face of the transmitter adjusts the neutral (center) point of the steering servo when the servo is at rest. Adjust this control to make the model drive straight with no steering input at the wheel.

Servo Reversing Switches

On the front of the transmitter there are three switches, one for throttle, one for steering, and one for shifting. Moving the switches reverses the direction of the servo. For example, if you turn your steering wheel right and the model moves left, then switch the steering servo reversing switch to correct the servo direction. The electronic trim may need readjustment after moving the switches.

Channel	Servo
1	Steering
2	Throttle
3	Shifting

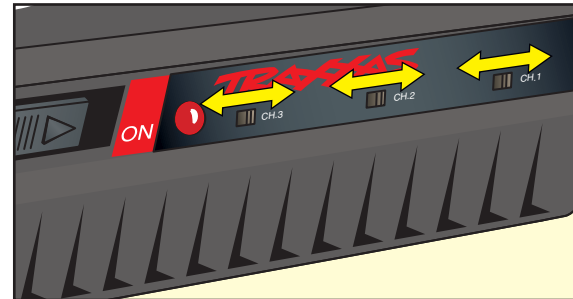



Remember, always turn the TQ-3 transmitter *on first* and *off last* to avoid damage to your E-Maxx.



Your EVX electronic speed control was set up with the radio from the factory. It is possible for the throttle trim control on the transmitter to have moved during transit or while handling the transmitter. If the motors run when the truck (EVX) is switched on, then turn the throttle trim control on the transmitter until the wheels stop. If anything more than a slight adjustment of the throttle trim control is required, then you should readjust your speed control. Refer to the Adjustments section on pages 25 and 26.

TQ-3 Radio System Rules

- ▶ Each time you prepare to run your E-Maxx, you must clear your frequency to be sure no one else in the area is using the same channel as you.

There are six possible channels, numbered 1 through 6. Each is represented by a color. Look at the crystal plugged into the back of your transmitter to determine which channel your truck is assigned to.

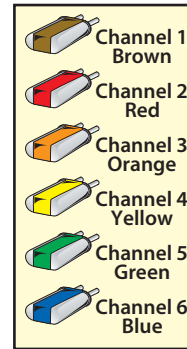

- ▶ Always turn your TQ-3 transmitter **on first** and **off last**. This procedure will help to prevent your E-Maxx from receiving stray signals from another transmitter, or other source, and running out of control.
- ▶ Always have the transmitter turned on before you plug in the battery packs in the model.

- ▶ Always use new or freshly charged batteries for the radio system. Weak batteries will limit the range of the radio signal between the receiver and the transmitter. Loss of the radio signal can cause you to lose control of your E-Maxx.

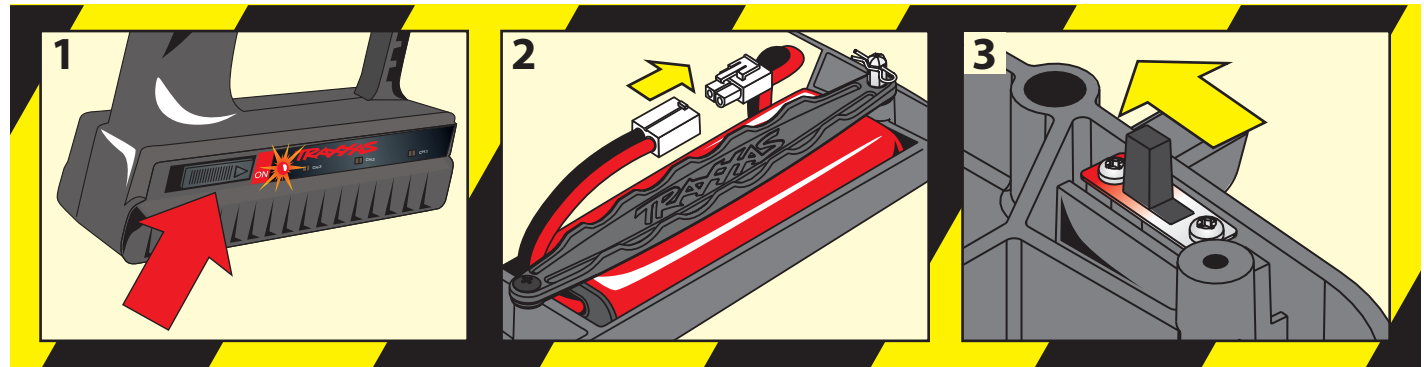

Using the TQ-3 Radio System

The TQ-3 Radio System was pre-adjusted at the factory. The adjustment should be checked, before running the model, in case of movement during shipping. Here's how:

1. Fully extend the chrome antenna mast on the transmitter and turn the switch on. The red indicator light on the transmitter should be solid red (not flashing).
2. Plug the NiCd batteries in the model into the electronic speed control.
3. Elevate the E-Maxx so that all four tires are off the ground. If you are holding the E-Maxx, grip it firmly. Make sure your hands are clear of the moving parts of the E-Maxx.

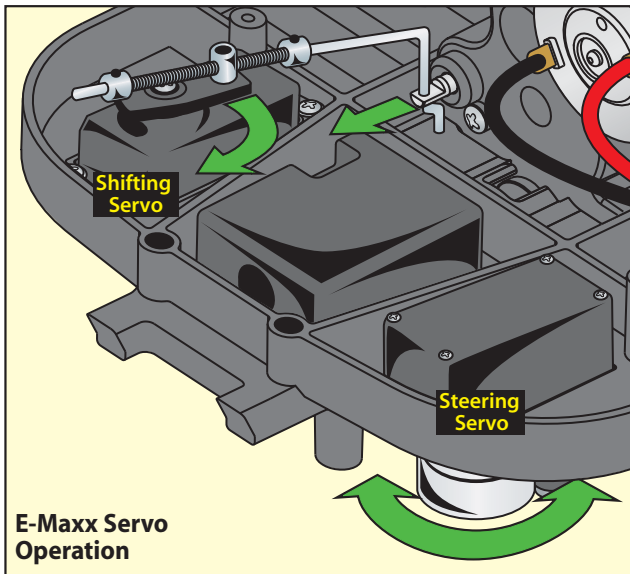

4. Move the switch in the E-Maxx to the "ON" position. The servo and speed control should jump and move to their idle (neutral) position. The motors may run momentarily, causing the E-Maxx to lurch.
5. Turn the steering wheel on the transmitter back and forth and check for rapid operation of the steering servo. Also, check that the steering mechanism is not loose or binding. If the steering operates slowly, check for weak batteries.
6. When looking down at model, the front wheels should be pointing straight ahead. If the wheels are turned slightly to the left or right, slowly adjust the steering trim control on the transmitter until they are pointing straight ahead.

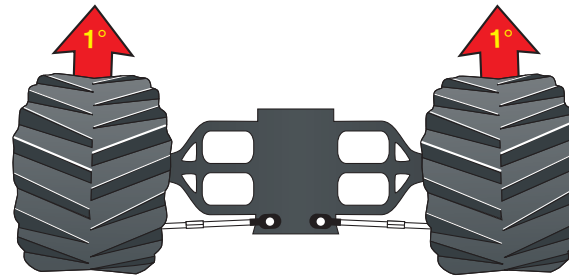

7. Operate the throttle trigger to ensure that you have full forward and reverse operation, and that the motor stops when the throttle trigger is at neutral.
8. Operate the shift button on the transmitter and check for rapid operation of the shifting servo. Push the shift button up for first gear; the servo will pull the shift rod out of the transmission. Push the shift button down for second gear; the servo will push the shift rod into the transmission.
9. Once adjustments are made, turn off the switch on your E-Maxx, followed by the handheld transmitter.

! When NiCd batteries begin to lose their charge, they will fade much faster than alkaline dry cells. Stop immediately at the first sign of weak batteries. Never turn the transmitter off when the battery pack is plugged in. The model could run out of control.

💡 Because your E-Maxx features zero-scrub-radius suspension and wide tires, the steering servo will not fully turn the front wheels when the vehicle is not moving.



Don't attempt to operate your E-Maxx if there are any problems with your radio system or radio interference at your location.

Range-Testing the TQ-3 Radio System

Before each running session with your E-Maxx, you should range-test your radio system to ensure that it operates properly.

1. Turn on the radio system and check its operation as described in the previous section (Using Your Radio System, pages 18-19).
2. Have a friend hold the model. Make sure hands and clothing are clear of the wheels and other moving parts on the E-Maxx.
3. Make sure your transmitter antenna is fully extended, and then walk away from the model with the transmitter until you reach the farthest distance you plan to operate the model.
4. Operate the controls on the transmitter once again to be sure that the model responds correctly.
5. Do not attempt to operate the model if there is any problem with the radio system or any external interference with your radio signal at your location.

Now it's time to have some fun! This section contains instructions on driving and making adjustments to your E-Maxx. Before you go on, here are some important precautions to keep in mind.



- ▶ Allow the E-Maxx to cool for a few minutes between runs.
- ▶ **The radio system is not waterproof.** Avoid driving through puddles or mud. If water gets into the electronics it could damage them.
- ▶ Do not continue to operate the truck with low batteries or you could lose control of it. Indications of low battery power include slow operation and sluggish servos (slow to return to center). Stop immediately at the first sign of weak batteries. When the batteries in the transmitter become weak, the red power light will begin to flash. Stop immediately and install new batteries.
- ▶ Do not drive the truck at night, on public streets, or in large crowds of people.
- ▶ If the truck becomes stuck against an object, do not continue to run the motors. Remove the obstruction before continuing. Do not push or pull objects with the E-Maxx.
- ▶ Because the E-Maxx is controlled by radio, it is subject to radio interference from many sources beyond your control. Since radio interference can cause momentary losses of control, allow a safety margin of space in all directions around the truck in order to prevent collisions.
- ▶ Use good, common sense whenever you are driving your truck. Intentionally driving in an abusive and rough manner will only result in poor performance and broken parts. Take care of your E-Maxx so that you can enjoy it for a long time to come.

Driving Tips

- ▶ Monster trucks by design have a high center of gravity that requires a different driving technique. To prevent rollovers, slow down as you approach turns and then apply strong

throttle through the turns. This technique will help the E-Maxx grab the surface and turn sharper.

- ▶ When jumping the E-Maxx, make sure to release the throttle just before the wheels contact the ground. Holding the throttle wide open as the truck lands could damage transmission and driveline components. Do not shift the transmission while the truck is in the air.
- ▶ Drive over large obstacles (such as curbs and rocks) at an angle, instead of head on. This will allow the suspension to articulate and absorb the impact much easier.

About Run Time

The E-Maxx is able to achieve long run times due to the greater efficiency of the high voltage electrical system. A large factor affecting run time is the type and condition of your batteries. The milliamp hour (mAh) rating of the batteries determines how large their "fuel tank" is. A 3000 mAh battery pack will theoretically run twice as long as a 1500 mAh sport pack. Because of the wide variation in the types of batteries that are available and the methods with which they can be charged, it's impossible for us to give you exact run times for the E-Maxx. Another major factor which affects run time is how the E-Maxx is driven. Our experience has shown that the run times are shorter when the truck is driven continuously, in high gear, at top speeds. In off-road situations with lower speeds and mostly low gear usage, expect much longer run times.

Tips for Increasing Run Time

- ▶ Use batteries with the highest mAh rating you can purchase.
- ▶ Use a high-quality peak-detecting charger.
- ▶ Discharge the batteries completely after each run.
- ▶ Vary your speed. Continuous high-speed, high-gear running shortens the run time on the E-Maxx.
- ▶ Maintain your E-Maxx. Do not allow dirt or damaged parts to cause binding in the drivetrain. Keep the motors clean and the motor bushings lightly lubricated.

Adjusting Your E-Maxx



Factory toe-in settings can be achieved by

installing the rod ends on the turnbuckles until they bottom out against the shoulder. If you desire more toe-out, the tips of the rod ends must be trimmed to allow them to screw down further onto the turnbuckle threads.

Once you become familiar with driving your E-Maxx, you might need to make adjustments for better driving performance.

Adjusting the Slipper Clutch

The E-Maxx is equipped with an adjustable slipper clutch to protect the drivetrain from sudden shock loads (such as landing off of jumps with the motors at full throttle). Under normal conditions, the slipper clutch should not slip. **Before adjusting the slipper clutch, turn the radio system off and unplug the batteries in the E-Maxx.** If the motors turned while the adjustment wrench is inserted, you could be injured. **Do not touch the 3 metal heatsinks on the electronic speed control together with any metal object or tool when the speed control is turned on! This could damage the speed control.** Use the supplied universal wrench to tighten the slipper nut (clockwise) until it stops and then back the adjustment out 1/4 of a turn. You can make this adjustment without removing the gear cover, instead removing only the rubber plug in the center of the gear cover. If you notice any decrease in the E-Maxx's performance while making changes to the slipper clutch adjustment, then it may be too loose. The slipper must not be allowed to slip during normal acceleration or the slipper could be damaged.

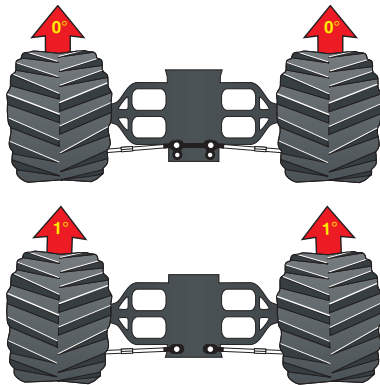

Adjusting the Toe-in

Your E-Maxx comes from the factory with zero degrees of toe-in in the front, and one degree of toe-in in the rear. You can adjust the toe-in on the front and rear of the truck. Set the steering trim on your transmitter to neutral. Now, adjust your steering turnbuckles so that both front wheels are pointing straight ahead and are

parallel to each other (0 degrees toe-in). This will ensure the same amount of steering in both directions. Adjust the rear toe control links so that the rear wheels have 1° of toe-in.

Adjusting the Camber

Two pivot balls are accessible through the spokes of each of the wheels on your E-Maxx. From the factory, the pivot balls are completely tightened into the suspension arms, which give each of the wheels -1° of camber. Unscrewing the bottom camber pivot ball with a 2.5mm hex wrench will increase the wheel's negative camber. You should not adjust the top pivot ball; unscrewing it will increase positive camber and will also change the wheel's toe-in.

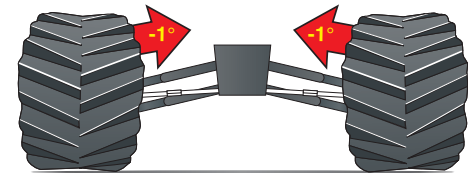
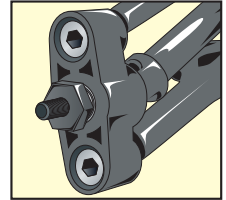

Adjusting the suspension

The E-Maxx has adjustable suspension so that it may be optimized for different kinds of terrain and driving styles.

Fine Tuning the Shocks

The eight shocks (oil dampers) on your E-Maxx have tremendous influence on its handling. Whenever you rebuild your shocks, or make any changes to the pistons, springs or oil, always do it carefully and in sets (front or rear). Piston head selection depends on the range of oil viscosities that you have available. For example, using a two-hole piston with lightweight oil will give you the same damping as a three-hole piston with heavier oil. We recommend using two-hole pistons with a range of oil viscosities from 10W to 40W (available from your hobby shop). The thinner viscosity oils (30W or less) flow with less resistance and provide less damping, while thicker oils provide more damping. Use only 100% pure silicone shock oil to prolong seal life. From the factory, the E-Maxx uses 30W oil.

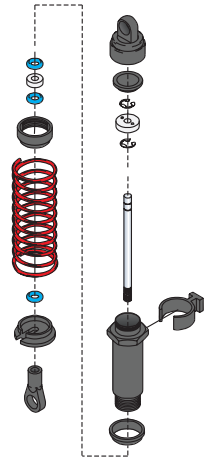

The ride height for the E-Maxx can be adjusted by adding or removing the clip-on spring pre-load spacers. Note that changes in ride height will occur when changes in shock angle or spring rates are made. You can compensate for ride height changes by changing the pre-load spacers on the shocks

Motors and Gearing

The Titan™ 550 Motors on your E-Maxx have been carefully designed to match the needs of the E-Maxx. The Titans are made to run efficiently at high voltage to provide **more torque and longer run times**. We do not recommend converting the E-Maxx to a typical low voltage setup using traditional 540 size motors. While these components will physically fit into the E-Maxx, the system will not run as efficiently, losing power in the form of motor and battery heating. The result will be shorter run times, high current draw, and extreme battery and motor temperatures. If you are considering replacement motors, look for 550 motors capable of 12 or more volts.

The E-Maxx is equipped from the factory with a 66-tooth spur gear and 18-tooth pinion gears. E-Maxx has a large range of gearing making it suitable for many different types of applications and environments. If you want more acceleration and less top speed, use a smaller pinion gear (fewer teeth, higher numerical ratio). For more top speed, use a larger pinion gear (lower numerical ratio). The overall reduction is the number of turns the motor makes for one revolution of the tire. Higher numerical ratios provide more torque, lower numerical ratios provide more top speed. **With the Titan motors, do not use a pinion gear larger than 20-tooth with the stock 66-tooth spur gear or, do not go lower numerically than 16.1 to 1 gear ratio in high gear.**

Caster Adjustment

The E-Maxx offers the ability to adjust the caster angle of the front suspension. Caster adjustment may be used to influence the understeer/ oversteer handling characteristics of the E-Maxx. Increasing the caster angle will increase the tendency of the truck to oversteer (less traction on the rear tires, more traction on the front tires), while decreasing the caster angle will cause the truck to have a tendency to understeer (push in the turns). This effect becomes more pronounced at higher steering angles and

higher spring rates. Caster is adjusted by repositioning the shims on the pivot point of the upper suspension arms.

The stock caster setting is 7-degrees with one shim at each end of the arm. Reduce the caster angle to 4-degrees by removing the rear shim and inserting it next to the front shim. The caster angle can be increased to 10-degrees by removing the front shim and inserting it next to the rear shim.

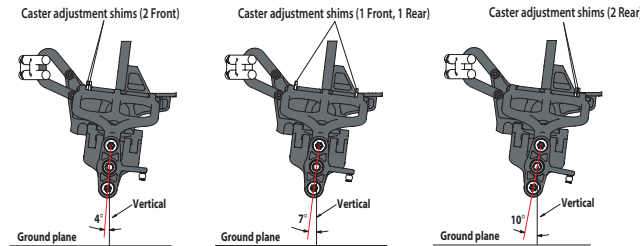

Shock Mounting Positions

Big bumps and rough terrain require a softer suspension with the maximum possible suspension travel and ride height. Racing on a prepared track or on-road use requires a lower ride height and firmer, more progressive suspension settings. The more progressive suspension settings help reduce body roll (increased roll stiffness), dive during braking, and squat during acceleration. Upper shock mounting position (A) should generally be used with lower shock mounting positions 1 and 2. Upper shock mounting position (B) should be generally be used with lower shock mounting positions 3 and 4. The innermost upper shock mounting position (0) can be used for tuning with the inner pair of lower shock mounting positions on the arm (1,2). It is not compatible with lower shock mounting positions 3 and 4. Other combinations may be used to achieve individualized suspension settings.

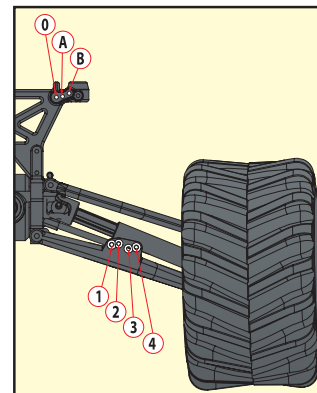

		Spur Gear			
		64	66	70	72
12	1st	43.36	45.99	47.30	
	2nd	26.92	28.56	29.37	
13	1st	40.03	42.45	43.66	
	2nd	24.85	26.36	27.11	
14	1st	36.04	37.17	39.42	40.55
	2nd	22.38	23.08	24.48	25.18
15	1st	33.64	34.69	36.79	37.84
	2nd	20.89	21.54	22.85	23.50
16	1st	31.54	32.52	34.49	35.48
	2nd	19.58	20.19	21.42	22.03
17	1st	29.68	30.61	32.46	33.39
	2nd	18.43	19.01	20.16	20.73
18	1st	28.03	28.91	30.66	
	2nd	17.41	17.95	19.04	
19	1st	26.56	27.39	29.05	
	2nd	16.49	17.01	18.04	
20	1st	25.23	26.02		
	2nd	15.67	16.15		
21	1st	24.03	24.78		Do not use with Titan motors.
	2nd	14.92	15.39		
22	1st	22.93	23.65		
	2nd	14.24	14.69		

Overall Reduction



For easier access to the rear-most shock mounting screw, remove the one end of the rear turnbuckle. In the front, remove the suspension pin from the lower front suspension arm to gain easier access to the lower shock mounting screws.

Lower Shock Mounting Positions

In the out-of-the-box configuration, the shocks are installed in position (A) on the shock tower and position (2) on the lower suspension arm. This setting allows for moderate suspension travel and ride height. The more vertical position of the shocks allows for lower shock progression and the soft, plush feel that's characteristic of a Traxxas Maxx Truck.

The outer pair of holes on the lower suspension arm should be used to lower the ride height of the E-Maxx, and increase the spring force (at the wheel). This setting will improve high-speed cornering on smoother terrain by lowering the center of gravity and providing a firmer suspension feel. Body roll, brake dive, and squat will be reduced.

Spring rate (at the wheel) increases as the lower shock mounting position is moved from position (1) to position (4). This is equivalent to using stiffer springs. Use higher spring rate settings for flatter terrain with smaller and fewer bumps, and lower spring rate settings for bigger bumps.

Ride height decreases as the lower shock mounting position is moved from position (1) to position (4). Each pair of lower shock mounting holes (1,2 and 3,4) has equal ride height. Use lower ride height for high-speed cornering and flat terrain, and when racing on relatively smooth tracks. Increase the ride height for rougher terrain and tracks.

Upper Shock Mounting Positions

The upper shock mounting positions will have suspension effects opposite from the lower shock mounting positions.

Spring rate (at the wheel), increases as the upper shock mounting position is moved from position (A) to position (B).

Ride height is not affected by changes in the upper shock mounting position.

Use the chart below to see the effect of the various shock mounting positions. The horizontal length of the lines indicates the amount of suspension travel. The angle or slope of the lines indicates the spring rate (at the wheel).

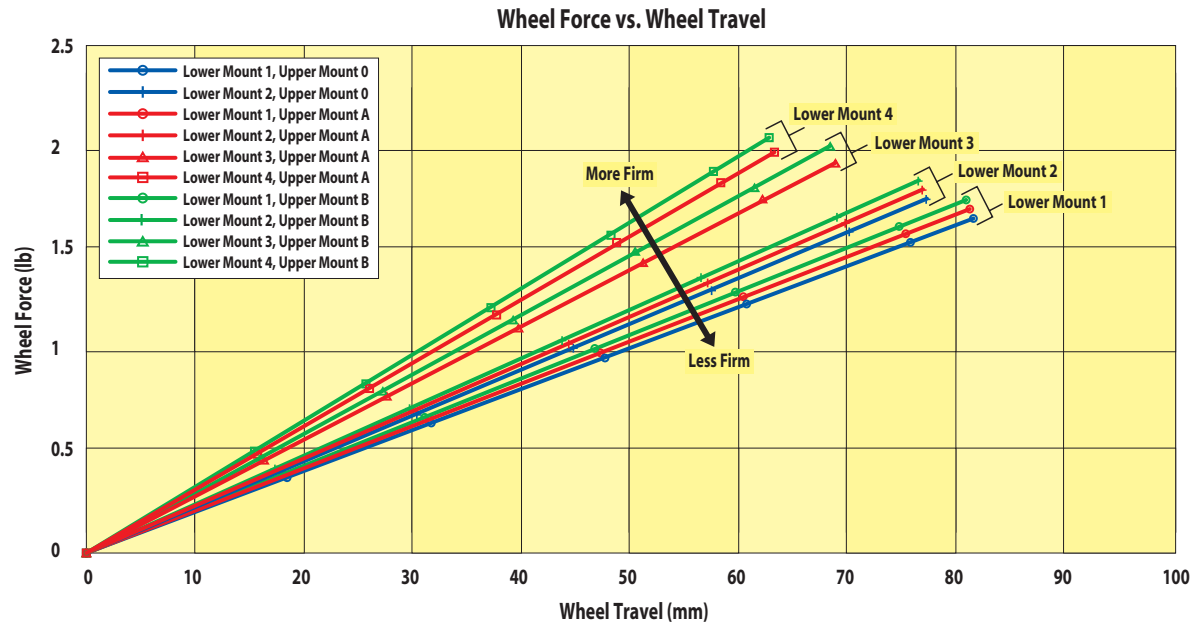

Adjusting the Speed Control

The EVX electronic speed control installed in your E-Maxx has been factory set and should not require any adjustments. The EVX is a reliable and rugged reversible speed control for use with two 6 or 7-cell battery packs and the stock Traxxas E-Maxx motors.

The EVX has three user-selectable throttle profiles:

Profile #1: Forward with brakes and reverse: Novak's Smart Braking™ Circuitry brings the model to a slow speed before engaging reverse to save your vehicle's gearbox and reduce speed control heating. Forward and reverse are proportional.

Profile #2: Forward-only with brakes: Novak's Reverse Disable Circuitry locks-out reverse for forward-only or racing use. Brakes are enabled.

Profile #3: Forward with 25% reverse: For applications where reduced speed in the reverse direction is desirable.

EVX Wiring Diagram - Follow this diagram exactly! The pos(+) and neg(-) battery and motor inputs are not reversible.

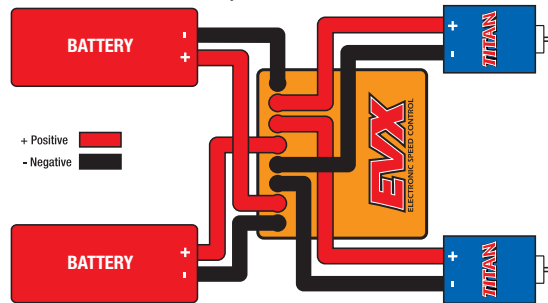

Precautions

Follow these extra safety precautions for your protection and to ensure long life for the EVX speed control.

- ▶ **Water and electronics don't mix!** Do not operate model in or around water. Never allow water, moisture, or other foreign materials to get inside the speed control.
- ▶ **Disconnect the batteries.** Always disconnect the battery pack from the speed control when not in use.
- ▶ **Transmitter on first.** Turn on your transmitter before the speed control so you will have control of the radio equipment.
- ▶ **Don't get burned!** The transistor tabs and the heat sinks can

get extremely hot, so be careful not to touch them until they cool. Supply adequate airflow for cooling.

- ▶ **Always use heat sinks.** Three heat sinks are factory-installed on the speed control and must be used for maximum cooling and performance.

These additional precautions apply if the stock E-Maxx is modified in the future. Please be aware that damage to the speed control caused by modification of the E-Maxx or EVX will not be covered by the warranty. This includes changing the connectors.

- ▶ **Use stock connectors.** If you decide to change the battery or motor connectors, only change one battery or motor connector at a time. This will prevent accidentally mis-wiring the speed control. If the EVX is not wired exactly as shown in the diagram, it can be damaged!
- ▶ **Use neutrally timed motors.** The motors installed in the E-Maxx are neutrally timed. If you replace the motors, the motors must have 0° timing. Modified motors (with adjustable end bells) timed to 0° or Johnson/ Mabuchi (closed end bell) motors are recommended. Using motors with other than 0° timing will draw excess current in reverse, causing the speed control to overheat and premature motor wear.
- ▶ **Motor capacitors required!** If the factory installed stock motors are replaced, three 0.1µF (50V) ceramic capacitors should be properly installed on every motor to prevent radio interference. These capacitors are available from your hobby dealer (Novak Kit #5620).
- ▶ **No reverse voltage!** The speed control is not protected against reverse polarity voltage. If changing the battery and/or motor, be sure to install the same type of connectors to avoid damage to the speed control. Removing the battery connectors on the speed control or using the same-gender connectors on the speed control will void the product's warranty.
- ▶ **Don't let the transistor tabs touch!** Never allow the three separate transistor banks to touch each other or any exposed metal. This will create a short circuit and damage the speed control.
- ▶ **Insulate the wires.** Always insulate exposed wiring with heat shrink tubing to prevent short circuits.



Operating Your E-Maxx on 14 Cells

The EVX electronic speed control is capable of handling 14 cells to power the twin Titan motors. Only use the 14 cell configuration with the EVX and stock Titan motors. For more information on operating the E-Maxx with 14 cells, and complete 7 cell pack assembly instructions, go to www.Traxxas.com/7cell

Using an Aftermarket Transmitter with the EVX.

The following instructions are provided as reference only for those who are using an aftermarket transmitter in place of their factory TQ-3.

1. Set the High ATV or EPA to the maximum setting. This is the amount of servo throw at full throttle.
2. Set the Low ATV, EPA, or ATL to the maximum setting. This is the amount of servo throw at full brakes.
3. Set the Exponential to the zero setting. This adjusts the throttle channel linearity.
4. Set the Throttle Channel Trim to the middle setting. This adjusts the neutral position and increases or decreases the amount of coast braking.
5. Set the Throttle Channel Reversing Switch to either position. Do not change the switch position after programming.
6. Set the Electronic Trigger Throw Adjustment to 50% throttle and 50% brake throw (or 5:5). This adjusts the transmitter's throttle trigger throw on electronic/digital transmitters.
7. Set the Mechanical Trigger Throw Adjustment to a position with 1/2 throttle and 1/2 brake throw. This adjusts the transmitter's throttle trigger throw on mechanical/analog transmitters.

Transmitter Adjustments for the EVX (TQ-3)

Before attempting to program your EVX, it is important to make sure that your transmitter is properly adjusted (set back to the factory defaults). Otherwise, you may not get the best performance from your speed control.

The Traxxas TQ-3 transmitter should be adjusted as follows:

1. Set the Throttle Neutral switch to the 50/50 setting. This adjusts the transmitter's throttle trigger throw to 1/2 throttle and 1/2 brake/reverse.
2. Set the Throttle Trim to the middle "0" setting. This adjusts the neutral position of the throttle servo.
3. Set the Channel 1 Servo Reversing Switch to the left position.
4. Set the Channel 2 Servo Reversing Switch to the right position.
5. Set the Channel 3 Servo Reversing Switch to the right position.
6. Do not change the position of any of the servo reversing switches after programming the EVX.

Speed Control Programming

To program the speed control, it should be connected to the receiver, and the transmitter should be adjusted as described in the previous section.

1. Disconnect the motors from the speed control.
2. Connect two fully charged battery packs to the speed control. Connect one JST plug (RED & BLACK wires) to one battery pack. Connect the other JST plug to the other battery pack.
3. Turn on the transmitter.
4. Turn on the speed control.
5. With the transmitter throttle at neutral, press and hold the ESC SET button until the status LED turns solid red, and then release the button. You are now in programming mode.

6. Pull the transmitter throttle trigger to the full throttle position. Hold it there until the status LED turns solid green. **Note:** The motors will not run during programming even if they are connected to the speed control.

7. Push the transmitter throttle trigger to full reverse. Hold it there until the status LED blinks green.
8. Release the transmitter throttle trigger allowing it to return to neutral. The status LED will turn solid red, indicating that the throttle is at neutral and the programming has been completed.
9. Connect the motors to the speed control. Connect the red speed control wires to motor's red positive (+) leads. Connect the black speed control wires to motor's negative (-) leads. Make sure the bullet connectors snap together securely. Refer to the wiring diagram on page 25 for assistance.

The EVX speed control is now programmed & ready to go!

- ▶ If the transmitter settings are changed, it will be necessary to complete the programming sequence again.
- ▶ If the SET button is released before the LED turns solid red in step 5, the LED will blink 7 times and then return to the normal operation mode.
- ▶ If you experience any problems during programming, turn off the speed control and repeat the programming steps.

Speed Control Throttle Profile Selection

The speed control is factory set to Profile #1 (forward/reverse/brake operation). To disable the reverse (Profile #2), or reduce the reverse speed to 25% (Profile #3), follow these steps. The speed control should be connected to the receiver and the transmitter adjusted as described above.

1. Connect two fully charged battery packs to the speed control. Connect one JST plug (RED & BLACK wires) to one battery pack. Connect the other JST plug to the other battery pack.

2. Turn on the transmitter.
3. Turn on the speed control.
4. Press and hold the ESC SET button until the status LED turns from solid red to solid green. Immediately release the ESC SET button when it changes to green.
5. The LED will now flash red. The number of red flashes indicates the active throttle profile.

Profile #	Description	Flashes
1 (Default)	Forward/Reverse/Brakes	1
2	Forward only/Brakes	2
3	Forward/25% Reverse/Brakes	3

6. Press the ESC SET button to select the throttle profile. Each press will advance the setting to the next profile. Note: To change the profile you must press the ESC SET button immediately after the LED flashes the current setting. Once the LED flashes the desired setting number, wait and the LED will turn green and the EVX will exit the programming mode.

Maintaining and Storing Your E-Maxx



Denatured alcohol (available from home centers and paint supply stores) in a spray bottle is an extremely effective cleaner. Be sure to wear safety glasses and gloves when working with denatured alcohol. Remove the radio system and ESC before cleaning with denatured alcohol or other cleaners.



Always wear eye protection when using compressed air or spray cleaners and lubricants.

Your E-Maxx requires timely maintenance in order to stay in top running condition. The following procedures should be taken very seriously.

Inspect the vehicle for obvious damage or wear. Look for:

1. Cracked, bent, or damaged parts
2. Check the wheels and steering for binding.
3. Check the operation of the shock absorbers.
4. Check the wiring for any frayed wires or loose connections.
5. Check the tightness of the front pivot balls.
6. Check the mounting of the receiver and servo and electronic speed control.
7. Check the tightness of the wheel nuts with a wrench.
8. Check the operation of the radio system, especially the condition of the batteries.
9. Check for any loose screws in the chassis structure or suspension.
10. The steering servo saver will wear out over time. If the steering becomes loose, the servo saver should be replaced.
11. Inspect the gears for wear, broken teeth, or debris lodged between the teeth.
12. Check the tightness of the slipper clutch.

Other periodic maintenance:

- ▶ **Slipper clutch pegs** (friction material): The slipper clutch pegs will wear over time and require replacement. The life of the pegs depends on how the slipper clutch was adjusted and how the E-Maxx was used. If the slipper will not tighten or you are seeing signs of wear on the face of the gear, then the pegs should be replaced.
- ▶ **Chassis:** Keep the chassis clean of accumulated dirt and grime. Periodically inspect the chassis for damage
- ▶ **Steering:** Over time, you may notice increased looseness in the steering system. There are several components which will wear out from use: the servo saver (Traxxas part #3744), the bellcrank bushings (Traxxas part #4943), and the tie rod ends (Traxxas part #2742). Replace these components as needed

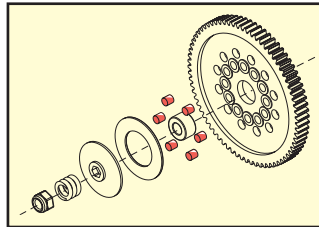

to restore factory tolerances. The bellcrank bushings may be replaced with 5x8mm ball bearings (Traxxas part #2728).

- ▶ **Motors:** Every 10-15 runs, remove, clean, and lubricate the motors. Use a product such as electric motor cleaning spray to flush dirt out of the motors. After cleaning, lubricate the bushings at each end of the motor with a drop of light-weight electric motor oil.
- ▶ **Shocks:** Keep the oil level in the shocks full. Use only 100% pure silicon shock oil to prolong the life of the seals. If you are experiencing leakage around the top of the shock, inspect the bladder in the top cap for signs of damage or distortion from overtightening. If the bottom of the shock is leaking, then it is time for a rebuild. The Traxxas rebuild kit for two shocks is part #2362.
- ▶ **Suspension:** Periodically inspect the truck for signs of damage such as bent or dirty suspension pins, bent turnbuckles, loose screws, and any signs of stress or bending. Replace components as needed.
- ▶ **Driveline:** Inspect the driveline for signs of wear such as worn drive yokes, dirty axle half shafts, and any unusual noise or binding. If a U-joint pops apart then it is time to replace the part. Remove the gear cover and inspect the spur gear for wear and check the tightness of grub screws in the pinion gears. Tighten, clean, or replace components as needed.

Storage

When you are through running the E-Maxx for the day, blow it off with compressed air or use a product such as denatured alcohol to remove dirt and grime from the truck. When using denatured alcohol, unplug and remove the batteries. Be careful not to spray it directly on the electronic components or into the motors. Allow the E-Maxx to dry completely before reconnecting the batteries. **Denatured alcohol is flammable and should not be used where a spark may occur (such as in the motors or battery connectors).**

Always disconnect and remove the batteries from the E-Maxx whenever the E-Maxx is stored. If the E-Maxx will be stored for long time, then also remove the batteries from the transmitter. The following section addresses some very basic ESC and radio

Troubleshooting Your E-Maxx

questions you may have about your E-Maxx. Most questions arise from simple user errors or minor adjustments that are easy to correct. If you can't find a solution for your E-Maxx here, then visit our Web site at www.Traxxas.com and click on the Customer Support menu. There you will find a much more extensive and detailed online troubleshooting area. In addition, you may call Traxxas Customer Service at 1-888-TRAXXAS (outside the US call 972-265-8000).

Radio system does not work properly:

- ▶ If the power light on the transmitter does not come on, check for proper battery installation and that the batteries are new and/or fully charged. If the power light is blinking, then the transmitter batteries are weak and should be replaced. See page 13 for more details.
- ▶ If the transmitter light is on but the radio is still not responding, check for proper installation of batteries in the model and that the batteries are new and/or fully charged. Check to make sure the on/off switch on the model is in the on position. Check for damaged wires, a loose crystal, or loose connections. See page 14 for more details.

Short radio range:

- ▶ If the radio range appears short, then first check to make sure the transmitter antenna is fully extended and that the antenna in the E- is in place and has not been cut or damaged. Next, make sure the batteries are all fully charged. Finally, if you are still experiencing short range, try a different location. Sometimes there can be interference from various sources that can cause your radio to malfunction.

Steering channel works but the motors will not run

- ▶ The speed control has thermally shut down. Allow the speed control to cool down. Use a milder motor or a smaller pinion gear. Check the drive train for restrictions. Check the motor connections. Check the motors.
- ▶ One motor is wired backwards. Check the wiring and correct.
- ▶ Make sure the speed control is plugged into the throttle channel of the receiver. Check operation of the throttle channel with a servo.
- ▶ Possible internal damage. Return the EVX to Traxxas for service.

EVX will not go into programming mode

- ▶ Make sure the EVX is plugged into channel 2 (the throttle channel) on the receiver. If it is plugged into channel 3 or the battery terminal, it will not go into programming mode.

Receiver glitches/throttle stutters during acceleration

- ▶ Motor capacitors broken or missing - Check & replace capacitors.
- ▶ The receiver or antenna is too close to power wires or the batteries.
- ▶ Bad connections - Check the wiring and connectors.
- ▶ Motor(s) worn - Replace the motors.
- ▶ Excessive current to motor - Use a milder motor or a smaller pinion gear.

Motor and steering servo do not work

- ▶ Check the wires, radio system, crystals, battery and motor connectors, and the battery packs.
- ▶ Possible internal damage. Return the EVX to Traxxas for service.

Model runs slowly / slow acceleration

- ▶ Check the motor and battery connectors.
- ▶ Bad battery or motor(s). Check the operation with known good batteries and motors.
- ▶ Incorrect transmitter or speed control adjustment. Refer to the "Transmitter Adjustment" and "Speed Control Programming" sections.

Motor runs backwards

- ▶ Both motors wired backwards - Check the wiring and correct.

ESC is melted or burned/ESC runs with the switch off

- ▶ Internal damage. Return the EVX to Traxxas for service.

- Antenna (receiver) 15
 - tip* 15
 - tube* 15
- Antenna (transmitter) 11, 15
- Antenna Mount 7
- Axle pins 9
- Batteries 6, 12, 13, 14, 23
 - alkaline* 13, 19
 - low* 21
 - mAh* 14, 21
 - Ni-MH (nickel-metal hydride)* 13
 - NiCad (nickel-cadmium)* 6, 12, 13, 19
 - receiver* 13
 - rechargeable* 13
 - side-by-side packs* 14
 - stick packs* 14
 - transmitter* 13
- Battery compartment (Chassis) 7
- Battery compartment (Transmitter) 11, 13
- Battery Connectors 11
- Battery Hold-Down 7, 14
- Body mount 7
- Bulkhead 7
- Bumper 7
- Bumper mount 7
- CA glue 9
- Camber 22
- Caster 23
- Channel 11, 12, 18
- Channel number 12
- Charger 6, 14
 - peak-detecting* 14
 - timed* 14
- Chassis 7, 28
- Clearing your frequency 12
- Compressed air 28
- Cross-brace 7
- Crystal 12, 18
- Curbs 21
- Customer service 4
- Decals 10
- Denatured alcohol 28
- Differential 7
- Driveline 28
- Driving Tips 21
- E-mail 4
- Electronic Speed Control (EVX) 7, 11, 18, 29
 - adjusting* 25
 - heat sinks* 25
 - modification* 25
 - precautions* 25
 - profile #1* 25
 - profile #2* 25
 - profile #3* 25
 - programming* 26, 29
 - throttle profile selection* 26
 - transmitter adjustments* 26
- Flag color 12
- Frequency band 12, 15
- Gearing 23
- Half shaft 7
- Hex hubs 9
- Jumping 21
- Maintenance 28
- Motors (Titan) 7, 23, 28, 29
- Neutral position 12
- On/Off switch 7, 11
- Pinion gear 23
- Pivot balls 22
- Power Switch 11
- ProGraphix 10
- Quick Start 8, 9, 10, 13, 14, 15, 18, 19, 20
- Radio interference 20
- Radio System 12, 19, 21, 29
 - adjustments* 17
 - controls* 16
 - interference* 21
 - range-testing* 20
 - rules* 18
 - terminology* 12
 - terms* 12
- Range 15, 18, 20, 29
- Receiver 7, 11, 12, 15, 29
- Required equipment 6
- Ride height 23, 24
- Rollovers 21
- Run Time 21, 23
- Safety 5
- Servo reversing switches 11, 17
- Servos 7, 12, 29
 - shifting* 11
 - sluggish* 21
 - steering* 7, 11, 19
- Shifting 16-17, 21
 - high gear* 16-17
 - low gear* 16-17
 - shifting switch* 11, 19
- Shipping 4
- Shock Mounting Positions 23, 24
 - Lower* 24
 - Upper* 24
- Shock progression 24
- Shock Tower 7
- Shocks 7, 22, 28
 - Fine Tuning* 22
- Skid Plate 7
- Slipper Clutch 7, 22, 28
 - pegs* 28
- Spring rate 24
- Spur Gear 7, 23
- Steering 28, 29
- Steering mechanism 19
- Steering Trim, Electronic 11, 12, 17, 19
- Steering Wheel 11, 19
- Storage 28
- Supplies 6
- Support 4
- Suspension 28
 - adjusting* 23, 24, 25, 26, 27
- Suspension Arms 7
- Throttle Neutral Adjustment 11, 17
- Throttle Trigger 11, 17, 19
- Throttle Trim, Electronic 17, 18
- Toe-in 22
- Tools 6
- Torque 23
- Transmission 7
- Transmitter 12, 18
 - aftermarket* 26
 - indicator light* 19
 - power indicator* 11, 13
- Trim, see also Throttle Trim and Steering Trim 12
- Troubleshooting 29
- Turnbuckle 7
- Turns 21, 23
- Understeer 23
- Wheels 9
- Wiring diagram 11
- X-tal see also Crystal 12
- Zero-scrub-radius 19



Traxxas, 1100 Klein Road, Plano, Texas 75074, Phone: 972-265-8000, Toll-free 1-888-TRAXXAS
Traxxas U.K., P.O. Box 1128, Winterbourne, Bristol BS17-2SH, England, Phone: 44.117.956.1002
Internet: www.Traxxas.com, www.T-Maxx.com