

**NITRO
RUSTLER**



Nitro Rustler Owner's Manual

**Model
4410**

TRAXXAS®

Traxxas Corporation
Corporate Headquarters
1100 Klein Road
Plano, Texas 75074
Phone: 972-265-8000
Toll-free 1-888-TRAXXAS

Traxxas U.K.
P.O. Box 1128
Winterbourne, Bristol BS17-2SH
England
Phone: 44.117.956.1002

Internet
www.Traxxas.com
E-mail: support@Traxxas.com

Entire contents ©2003 Traxxas Corporation. Traxxas, Nitro Rustler, TRX 2.5, TQ, Top Fuel, EZ-Start, Ready-To-Race, and ProGraphix are trademarks or registered trademarks of Traxxas Corporation. Other brand names and marks are the property of their respective holders and are used only for purposes of identification. No part of this manual may be reproduced or distributed in print or electronic media without the express written permission of Traxxas.

020801

Introduction

Thank you for purchasing the Traxxas Nitro Rustler stadium truck. The Nitro Rustler is equipped with the all-new TRX 2.5 Racing Engine™ that elevates its performance from Ready-To-Run to Ready-To-Race®. Extremely high speed is possible once the engine has been properly broken in. The Nitro Rustler is a serious, performance-minded machine that incorporates race-bred suspension geometry for precise, responsive handling. The oil-filled Ultra Shocks can be fine tuned for most any track surface. The Magnum 281 transmission features smooth running ball bearings, an adjustable slipper clutch, heavy duty gears, and a rugged planetary gear differential. A powerful disc brake provides outstanding stopping performance.

The Nitro Rustler's new TRX 2.5 racing engine is the most powerful engine of its size ever available in a Ready-To-Run truck. Two years of engineering development and advanced design, along with thousands of hours of testing, puts the TRX 2.5 in a class by itself. Each part of the TRX 2.5 - from the air filter on the slide carburetor, to the tip on the dyno-tuned exhaust system - has been carefully engineered to provide maximum power over the broadest RPM range.

Traxxas was the first with standard on-board electric starting. The new second generation EZ-Start has evolved into an incredibly advanced and reliable starting solution, featuring thermal protection for the motor and built-in diagnostics to monitor the condition of the glow plug.

In this manual, we'll take you step-by-step through all necessary set-up, break-in, tuning, and operating procedures. **Even if you are an experienced R/C enthusiast, it is important for you to read and follow the procedures in this manual. Pay particular attention to the fuel requirements and break-in procedures. The advanced design of the TRX 2.5 racing engine does not follow traditional old-fashioned thinking regarding fuel and break-in procedures.**



- 4 Before You Proceed
- 5 Safety Precautions
- 6 Tools, Supplies and Required Equipment
- 7 Anatomy of the Nitro Rustler
- 8 Quick Start: Getting Up to Speed
- 9 Gluing the Tires
- 10 Decorating Your Nitro Rustler
- 11 The Traxxas TQ Radio System
- 21 The TRX 2.5 racing engine
- 37 Driving the Nitro Rustler
- 38 Adjusting Your Nitro Rustler
- 41 Trouble Shooting Your Nitro Rustler
- 43 Maintaining and Storing Your Nitro Rustler
- 45 Index

Before You Proceed

Carefully read and follow all instructions in this and any accompanying materials to prevent serious damage to your Nitro Rustler. Failure to follow these instructions will be considered abuse and/or neglect.

Before running your Nitro Rustler, look over this entire manual, and examine the truck carefully. If for some reason you decide the Nitro Rustler is not what you wanted, then do not continue any further. **Your hobby dealer absolutely cannot accept a Nitro Rustler for return or exchange after it has been run.**

Warnings, helpful hints, and cross-references

Throughout this manual, you'll notice warnings and helpful hints, identified by the icons below. Be sure to read them!



An important warning about personal safety or avoiding damage to your Nitro Rustler and related components.



Special advice from Traxxas to make things easier and more fun.



Refers you to a page with a related topic.

Support

If you have any questions about your Nitro Rustler or its operation, call the Traxxas Technical Support line toll-free at: 1-888-TRAXXAS (1-888-872-9927)

Technical support is available Monday through Friday from 8:30 am to 9:00pm central time. Technical assistance is also available at www.Traxxas.com. You may also e-mail customer support with your question at support@Traxxas.com. Join thousands of Traxxas R/C enthusiasts in our online community at www.ReadyToRun.org

Traxxas offers a full-service, on-site repair facility to handle any of your Traxxas service needs. Maintenance and replacement parts may be purchased directly from Traxxas, or you can save shipping and handling costs by purchasing them from your local hobby dealer.

Safety Precautions

All of us at Traxxas want you to safely enjoy your new Nitro Rustler. Operate your Nitro Rustler sensibly and with care, and it will be exciting, safe, and fun for you and those around you. Failure to operate your Nitro Rustler in a safe and responsible manner may result in property damage and serious injury. The precautions outlined in this manual should be strictly followed to help ensure safe operation. You alone must see that the instructions are followed and the precautions are adhered to.

Important Points to Remember

- ▶ R/C fuel is dangerous and highly poisonous. Always follow all directions and precautions printed on the fuel container.
- ▶ R/C fuel, especially when in a fuel dispensing bottle, may look like a cool drink to a child. Keep all fuel out of the reach of children at all times. Do not place fuel containers on the ground where children can get to them while you are driving.
- ▶ R/C fuel is flammable. Never allow smoking, sparks, heat or flame in the presence of fuel or fuel vapors.
- ▶ The engine and exhaust system may become extremely hot during use. Be careful not to touch the parts, especially when refueling or stopping the engine.
- ▶ Prolonged exposure to the engine exhaust can be harmful. Avoid breathing the engine exhaust. Always run your Nitro Rustler outdoors, in a well-ventilated area. Never run the engine indoors.
- ▶ Don't operate your Nitro Rustler at night, or anytime your line of sight to the model may be obstructed or impaired in any way.

- ▶ Never operate your Nitro Rustler in crowds of people or busy pedestrian areas. The Nitro Rustler is fast, and may cause injury to those unaware of its presence.
- ▶ Because the Nitro Rustler is controlled by radio, it is subject to radio interference from many sources beyond your control. Since radio interference can cause momentary loss of control, always allow a safety margin in all directions around your model to prevent collisions.
- ▶ The engine can be loud. If the noise makes you uncomfortable, wear ear protection. Be considerate of your neighbors by not running your model early in the morning or late in the evening.
- ▶ **Most importantly, use good common sense at all times.**





All instructions and precautions outlined in this manual should be strictly followed to ensure safe operation of your Nitro Rustler.



The Nitro Rustler is not intended for use by those under 16 years of age without the supervision of a responsible and knowledgeable adult.

Tools, Supplies, and Required Equipment

 For more info on batteries, see *Use the Right Batteries* on page 13.

 A peak-detecting charger is recommended for best performance and longest battery life. For more information, see *Use the Right Charger* on page 30.



Your Nitro Rustler comes with a set of specialty metric tools. You'll need to purchase other items, available from your hobby dealer, to operate and maintain your model.

Supplied Tools

Your Nitro Rustler comes with these specialty metric tools:

-  1.5mm hex wrench
-  2.0mm hex wrench
-  Glow plug (universal) wrench
-  4-way wrench
-  Turnbuckle wrenches
-  U-Joint wrench
-  Filter oil (for the foam air filter)
see page 27 for details

Batteries

-  12 AA alkaline batteries for the radio system
-  7.2-volt NiCad battery pack for the EZ-Start starting system
-  NiCad battery charger

Fuel



Traxxas Top Fuel™
10% quart - #5010 • 20% quart - #5020
10% gallon - #5060 • 20% gallon - #5070



Fuel dispensing bottle (Traxxas part #5001)

Other Required Tools and Supplies



Thin, hobby-quality cyanoacrylate instant tire glue (often called CA glue)



Safety glasses



#2 Phillips screwdriver



#1 Phillips screwdriver



Small flat-blade screwdriver (1/8 inch blade)



Hobby knife



After-run oil (WD-40™) to protect the engine from corrosion

Anatomy of the Nitro Rustler

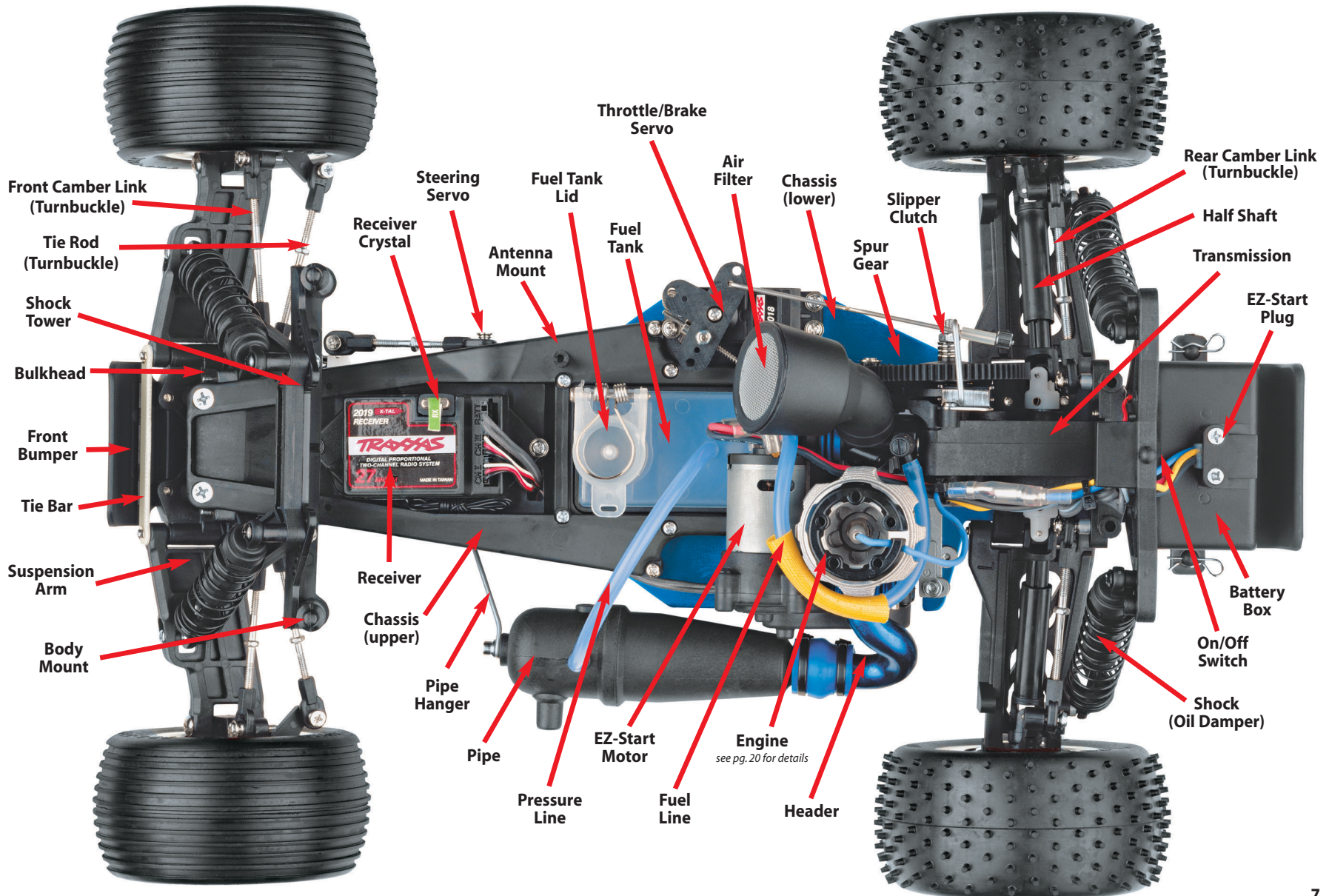

Quick Start: Getting up to Speed



The Quick Start Guide is not intended to replace the full operating instructions available in this manual. Please read this entire manual for complete instructions on the proper use and maintenance of your Nitro Rustler.



The following guide is an overview of the procedures for getting your Nitro Rustler running, from opening the box to breaking in and tuning your engine. Refer to the pages indicated for details on each step. Look for the Quick Start logo on the bottom corners of Quick Start pages.

- 1. Charge the battery pack • See sidebar, page 30**
The EZ-Start requires a fully charged 7.2-volt battery pack (not included).
- 2. Get the right fuel • See page 26**
Use Traxxas Top Fuel™ or consult with Traxxas before using other fuels.
- 3. Glue the tires • See page 9**
Glue the tires to the rims to prevent the rims from spinning inside the tires.
- 4. Install the antenna • See page 15**
Install the antenna mast in the Nitro Rustler.
- 5. Decal and Install the body • See page 10**
You will need to use the body during the break-in process so it's best to decal it before you use it on the truck.
- 6. Install batteries in the transmitter • See page 13**
The Nitro Rustler requires 8 AA alkaline or rechargeable batteries for the transmitter.
- 7. Install batteries in the model • See page 14**
The Nitro Rustler requires 4 AA alkaline or rechargeable batteries for the receiver.
- 8. Install the EZ-Start battery • See page 30**
Install and connect the 7.2-volt battery pack in the EZ-Start controller.
- 9. Turn on the radio system • See page 18**
Make a habit of turning the transmitter on first, and off last.
- 10. Check servo operation • See page 19**
Make sure the throttle and steering servos are working correctly.
- 11. Range test the radio system • See page 20**
Follow this procedure to make sure your radio system works properly at a distance and that there is no interference from outside sources.
- 12. Fill the fuel tank • See page 26**
Use your fuel-dispensing bottle to fill the tank.
- 13. Connect the EZ-Start to the model • See page 31**
Learn the proper way to use the EZ-Start electric starting system.
- 14. Start the engine • See page 32**
Learn to use the correct starting procedure for your TRX 2.5.
- 15. Break-in your engine • See page 32**
Follow the break-in instructions exactly to ensure the best-performing, longest-lasting engine.
- 16. Tune your engine • See page 34**
Learn how to set the fuel mixture needles for optimum engine performance.
- 17. Drive your Nitro Rustler • See page 37**
Driving tips and adjustments for your Nitro Rustler.
- 18. Maintaining your Nitro Rustler • See page 43**
Follow these critical steps to maintain the performance of your Nitro Rustler and keep it in excellent running condition.

Gluing The Tires

The tires on your Nitro Rustler must be glued to the rims using CA tire glue to prevent the rims from spinning inside the tires. You can glue the tires without removing the wheels from the truck. For clarity, these instructions show the process with the wheels removed.

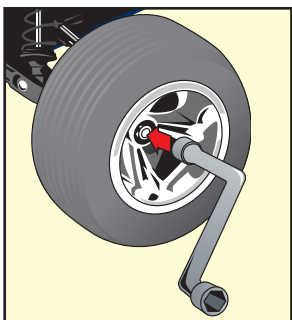

1. Remove a wheel from the Nitro Rustler using the larger (8mm) end of the glow plug (universal) wrench on the front wheels. Use the 4-way wrench (7mm) on the rear wheels.

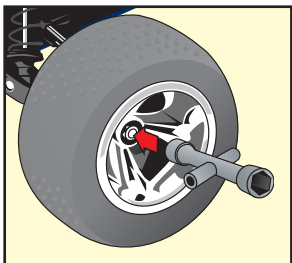

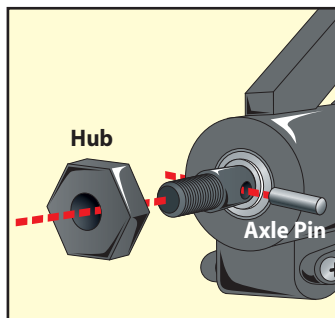

2. Use your thumb to push the side of the tire away from the rim. Place one or two drops of CA glue into the opening and release the tire. Capillary action will draw the glue around the bead of the tire.

3. Repeat step two at four or five points around the rim, until the tire is completely secured to the rim. Turn the rim over and repeat the process for the inside of the rim/tire. Repeat for the other 3 wheels.



4. Reinstall the wheels, make sure none of the axle pins have fallen out from behind the hex hubs (rear wheels only).

 Always wear safety glasses to prevent glue from splattering into your eyes.

 The acetone in fingernail polish remover will remove excess glue from your fingers.

 For best results while gluing, clean the bead of the tires and the grooves of the wheels with denatured alcohol before applying glue. This removes any mold release agent residue from the tires and wheels, providing a better bond.

Decorating Your Nitro Rustler

Applying The Decals

The ProGraphix painted body is covered with a protective film for shipping. You must remove this film before applying any decals.

To remove the film, lift a corner of the film and carefully pull it off the body in one continuous piece.

Your Nitro Rustler decals are die-cut for easy removal. Use a hobby knife to lift the corner of a decal and lift it from the backing.

Carefully position the decal over the desired location and press one side on the body. Pull the decal tight and use a finger to gradually smooth out any air bubbles as you apply the decal.

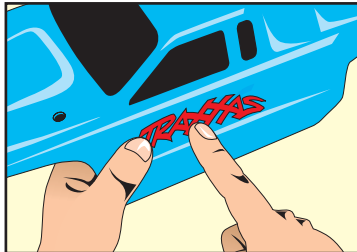
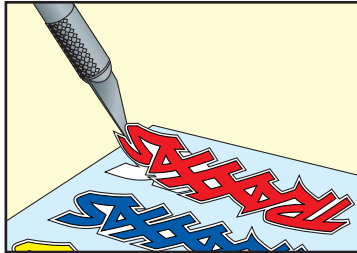
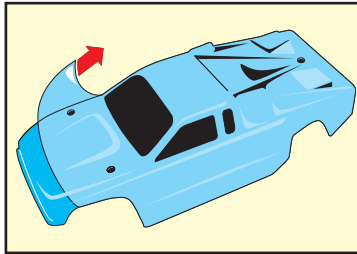

Look at the photos on the box for typical decal placement.

The Traxxas TQ Radio System

Your Nitro Rustler (model 4410) is equipped with the TQ Radio System. The TQ is a 2-channel system that provides high-power output up to a quarter mile and control for two servos. The Nitro Rustler makes use of two channels for throttle/brake and steering.

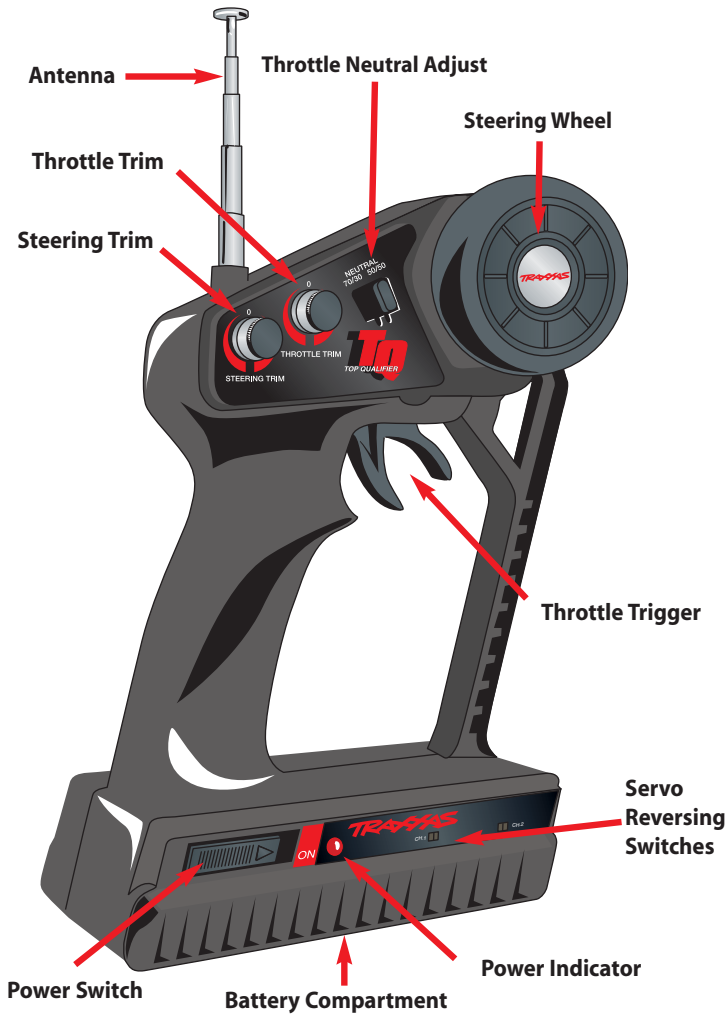

Nitro Rustler Wiring Diagram

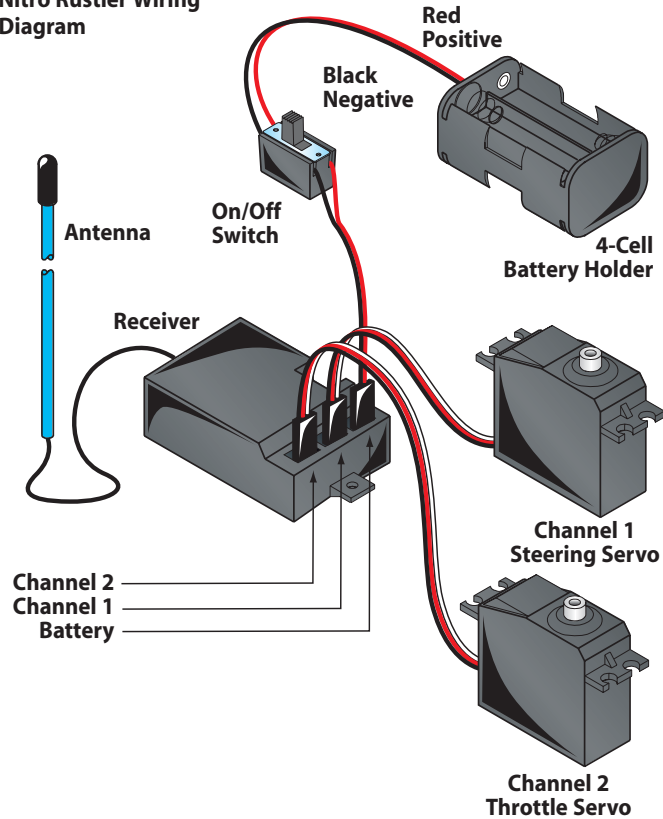









Learn terms related to the TRX 2.5 racing engine beginning on page 23.

Radio System Terminology

Please take a moment to familiarize yourself with these radio-system terms. They will be used throughout this manual.

Channel - The 27 MHz frequency band is divided into 6 channels so that up to six models can be operated simultaneously. Each channel is referred to by its flag color and channel number, as shown below.

Channel	Frequency Band	Flag Color	Traxxas Part No.
 1	26.995	Brown	2031
 2	27.045	Red	2032
 3	27.095	Orange	2033
 4	27.145	Yellow	2034
 5	27.195	Green	2035
 6	27.255	Blue	2036

Clearing your frequency - A routine, verbal check to make sure nobody else in your area is operating on the same channel. Always clear your frequency by calling out your channel number before operating your model. Wait or move to another area if your channel is already being used.

Crystal (X-tal) - The plug-in device that determines which channel the radio system will operate on. For each channel, there are two crystals, one for the receiver and one for the transmitter. Of those two crystals, the one marked with the lower number (.455 MHz lower) must be inserted into the receiver.

Frequency band - The radio frequency used by the transmitter to send signals to your Nitro Rustler. All Traxxas RTR models operate on a 27 MHz frequency band.

Neutral position - The standing position that the servos seek when the transmitter controls are at the neutral setting.

NiCad - Refers to rechargeable, nickel-cadmium batteries. The most economical choice, since they may be recharged up to 500 times.

Receiver - The radio unit inside your Nitro Rustler that receives signals from the transmitter and relays them to the servos.

Servos - Small motor units in your Nitro Rustler that operate the throttle and steering mechanisms.

Two-channel radio system - The TQ radio system, consisting of the receiver, the transmitter, and the servos. The system uses two channels: one to operate the throttle, one to operate the steering.

Transmitter - The hand-held radio unit that sends throttle and steering instructions to your Nitro Rustler.

Trim - The fine-tuning adjustment of the neutral position of the servos, made by turning the throttle and steering trim knobs on the face of the transmitter.

Installing Transmitter Batteries

Your TQ transmitter uses 8 AA batteries. The battery compartment is located at the base of the transmitter.

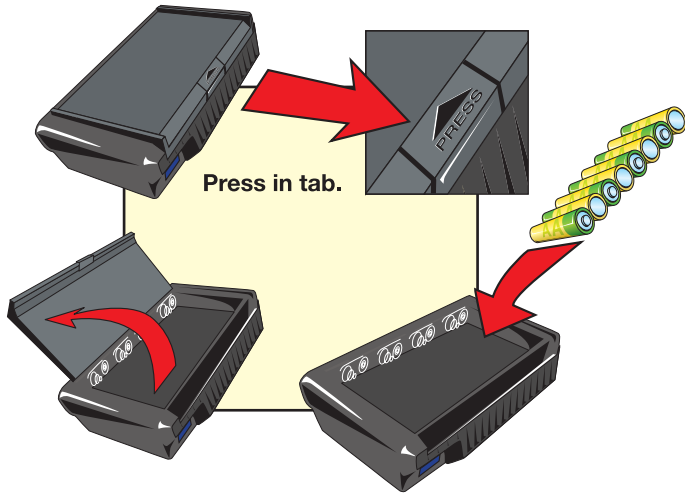

1. Remove the battery compartment door by pressing the tab and lifting the door up.
2. Install the batteries in the correct orientation as indicated in the battery compartment.
3. Reinstall the battery door and snap it closed.

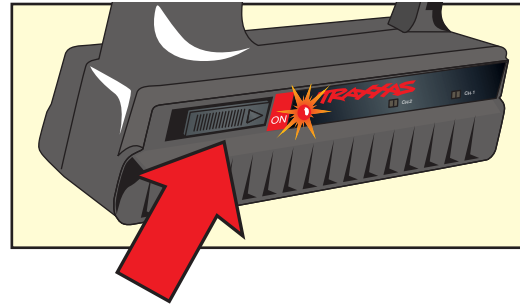

4. Turn on the transmitter and check the power indicator for a solid red light.

If the power indicator light flashes, then the transmitter batteries are weak, discharged or possibly installed incorrectly. Replace with new or freshly charged batteries. The power indicator light does not indicate the charge level of the receiver batteries in the model.

Use the Right Batteries

Your transmitter and receiver use AA batteries. Use new alkaline batteries, or rechargeable batteries such as NiCad or Ni-MH (nickel-metal hydride) batteries in your transmitter and receiver. Make sure rechargeable batteries are fully charged according to the manufacturer's instructions.

If you use rechargeable batteries in your transmitter, be aware that when they begin to lose their charge, they lose power much more quickly than regular alkaline batteries.

Caution: Discontinue running your Nitro Rustler at the first sign of weak batteries (flashing red light) to avoid losing control.



If the power indicator doesn't light red, check the polarity of the batteries. Check rechargeable batteries for a full charge.



Direct the battery wires through the slot in the battery cover. If the wires are not properly routed, they may become broken or shorted, causing radio system failure and loss of control.

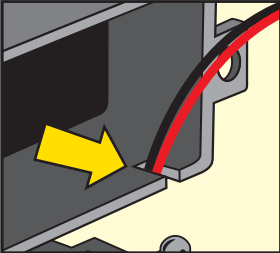

If you use rechargeable batteries in your receiver, be aware that when they begin to lose their charge, they lose power much more quickly than regular alkaline batteries. Signs of weak receiver batteries include sluggish steering response and shortened radio range. **Caution:** Discontinue running your Nitro Rustler at the first sign of weak batteries to avoid losing control.



If the radio system doesn't appear to work when the transmitter and receiver switches are turned on, check for correct battery installation.

Installing Receiver Batteries

The radio receiver in your Nitro Rustler uses 4 AA batteries. The battery holder for the receiver batteries is located underneath the battery cover on the rear bumper.

1. Remove the battery cover by removing the two body clips from the posts.
2. Remove the battery holder and install 4 AA alkaline batteries. Make careful note of the battery polarity by comparing against the diagrams in the battery holder.
3. Insert the battery holder into the battery cover.

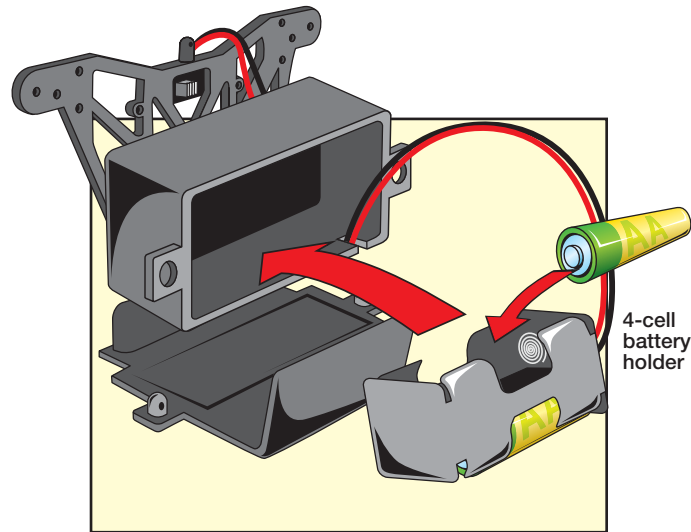



4. Reinstall the battery cover and secure with the body clips (see sidebar!).

Setting Up the Antenna

You must install the antenna mast (tube) before you operate your Nitro Rustler. You'll find the plastic antenna tube and tip in the bag with your manuals and documentation.

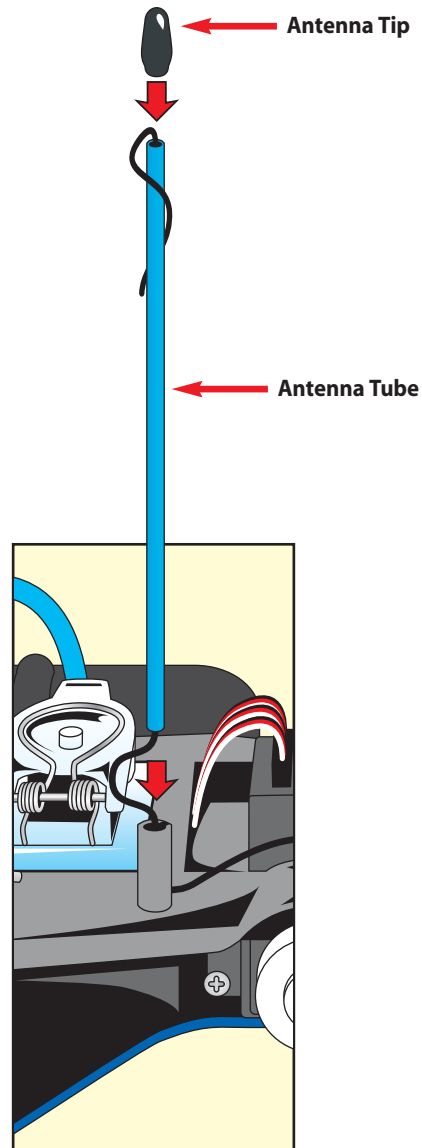
1. Locate the black antenna wire that exits the receiver. The Nitro Rustler receiver is mounted on the front of the upper chassis. The receiver is wrapped in a balloon for protection. The color of the balloon indicates the channel number (see page 12).
2. Pull the wire straight with your fingers and then insert the end of the wire into one end of the antenna tube. Push the wire all the way through the antenna tube.
3. Pull the remaining wire through the antenna tube, and then insert the base of the antenna tube into the molded post on top of the chassis.
4. Fold the remaining antenna wire over the top of the tube and secure it with the antenna tip.
5. On the transmitter, always fully extend the telescoping antenna when running your Nitro Rustler. Make a habit of holding the transmitter so that the antenna points straight up.



 Spray a little window cleaner on the antenna wire to make it easier to push through the antenna tube.

 Don't shorten the length of the antenna wire. Its length is tuned to the frequency band; cutting it could severely shorten the radio system's range.

 Don't push the transmitter antenna down from the top. Pull it down from the bottom, one segment at a time, to prevent binding and kinking the antenna mast.

TQ Radio System Controls

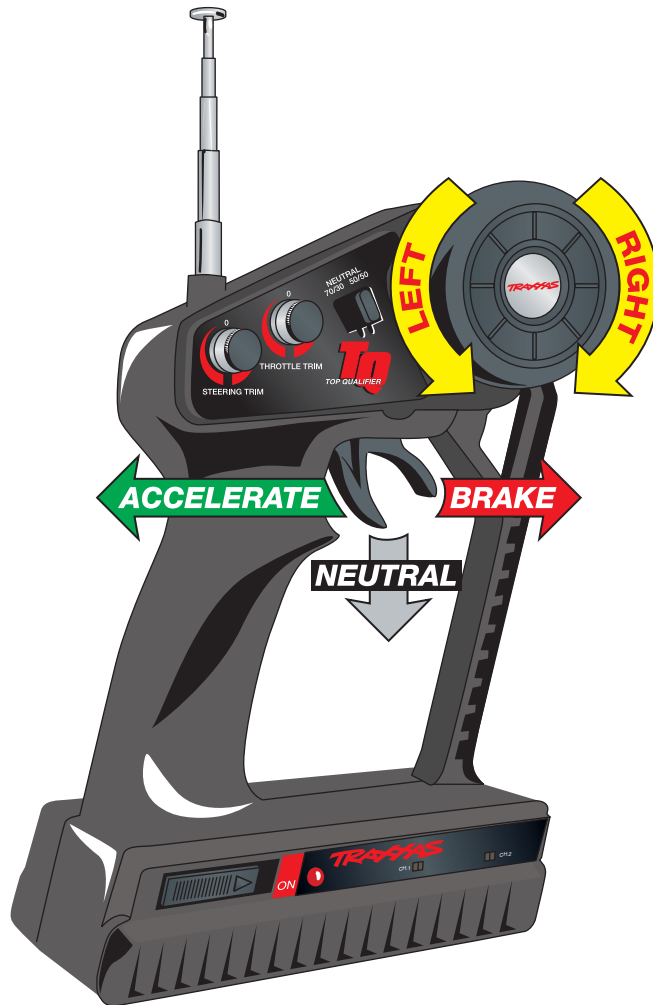

Other TQ Radio System Adjustments

In addition to the electronic throttle and steering trim controls, your radio system features throttle neutral adjustment and servo reversing switches.

Throttle Neutral Adjustment

The throttle neutral adjustment is located on the transmitter face and controls the forward/brake travel of the throttle trigger. Change the adjustment by pressing the button and sliding it to the desired position. There are two settings available:

- ▶ 50/50: Allows equal travel for both acceleration and braking.
- ▶ 70/30: Allows more throttle travel (70%) and less brake travel (30%).

50/50 is the required setting for the Nitro Rustler with the TRX 2.5 racing engine.

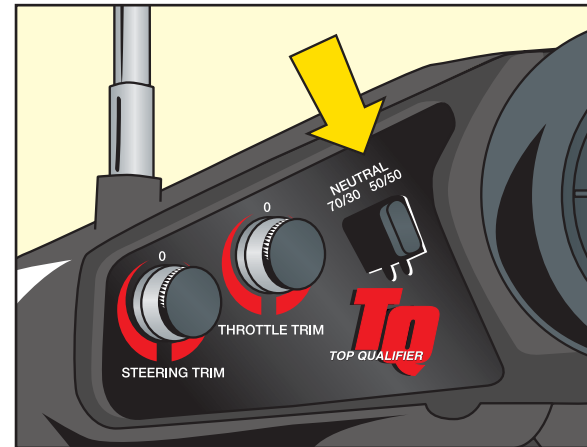

Electronic Throttle Trim

The electronic throttle trim located on the face of the transmitter adjusts the neutral (center) point of the throttle servo when the servo is at rest. This control has been preset for you at the factory. If necessary, adjust the control so that the carburetor is at idle, and the brakes are not applied (the model

will roll freely). Do not use the throttle trim to raise or lower the engine idle speed. Make the idle speed adjustment on the carburetor.

Electronic Steering Trim

The electronic steering trim located on the face of the transmitter adjusts the neutral (center) point of the steering servo when the servo is at rest. Adjust this control to make the model drive straight with no steering input at the wheel.

Servo Reversing Switches

The servo reversing switches are located on the front of the transmitter, next to the on/off switch. Moving a switch reverses the direction of the corresponding servo.

Each switch corresponds to a channel, as shown below. For example, if you turn the steering wheel to the right and your front wheels turn left, you would move the channel 1 switch to correct the servo direction. It may be necessary to adjust the corresponding trim control after moving a switch.

Channel	Servo
1	Steering
2	Throttle and braking

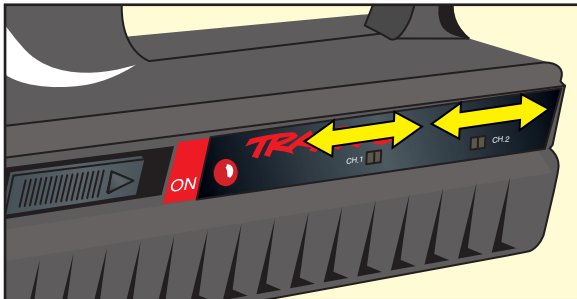



Remember, always turn the TQ transmitter *on first* and *off last* to avoid damage to your Nitro Rustler.



The Nitro Rustler's on/off switch does not have an indicator plate to show which direction is on. However, you can tell by looking at the wires that come out of the switchbox. Moving the switch towards the grey/grey-white wires turns the receiver on.

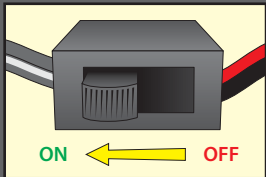

TQ Radio System Rules

- ▶ Each time you prepare to run your Nitro Rustler, you must clear your frequency to be sure no one else in the area is using the same channel as you.

There are six possible channels, numbered 1 through 6. Each is represented by a color. Look at the crystal plugged into the back of your transmitter to determine which channel your truck is assigned to.

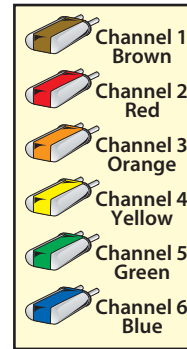

- ▶ Always turn your TQ transmitter **on first** and **off last**. This procedure will help to prevent your Nitro Rustler from receiving stray signals from another transmitter, or other source, and running out of control.
- ▶ Always have the transmitter and receiver turned on before you start the engine. Never turn the radio system off while the engine is running. The on/off switch in the model only turns the receiver on and off. It does not turn off the engine.

- ▶ Always use new or freshly charged batteries for the radio system. Weak batteries will limit the range of the radio signal between the receiver and the transmitter. Loss of the radio signal can cause you to lose control of your Nitro Rustler.

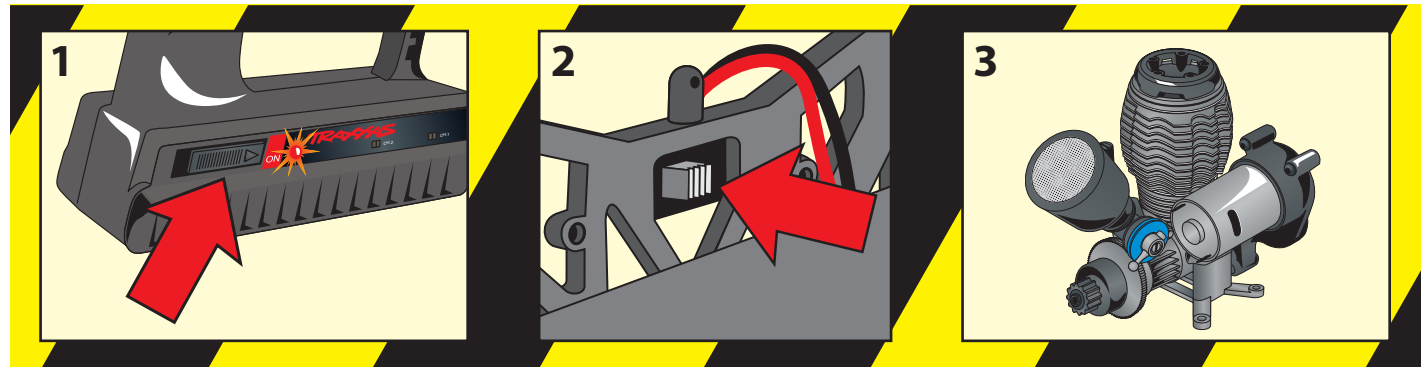

Using the TQ Radio System

The TQ Radio System was pre-adjusted at the factory. The adjustment should be checked, before running the model, in case of movement during shipping. Here's how:

1. Fully extend the chrome antenna mast on the transmitter and turn the switch on. The red indicator light on the transmitter should be solid red (not flashing).
2. Turn on the receiver switch in the model. The switch is located on the rear shock tower.
3. Position the Nitro Rustler so that its front wheels are off the ground.
4. Turn the steering wheel on the transmitter back and forth and check for rapid operation of the steering servo. Also, check that the steering mechanism is not loose or binding. If the steering operates slowly, check for weak receiver batteries.
5. When looking down at model, the front wheels should be pointing straight ahead. If the wheels are turned slightly to

the left or right, slowly adjust the steering trim control on the transmitter until they are pointing straight ahead.

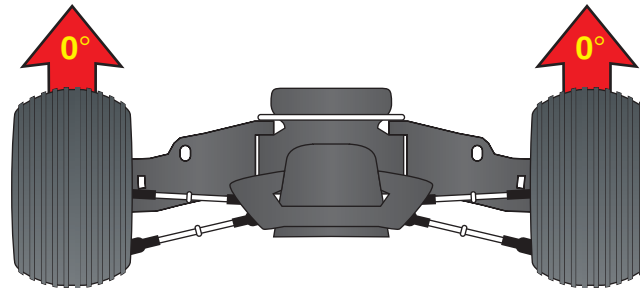

6. Operate the throttle trigger on the transmitter and check for rapid operation of the throttle servo. When the throttle trigger is pulled back, the carburetor should open. When the throttle trigger is pushed all the way forward, the brake should lock.
7. Once adjustments are made, turn off the receiver on your Nitro Rustler, followed by the handheld transmitter.

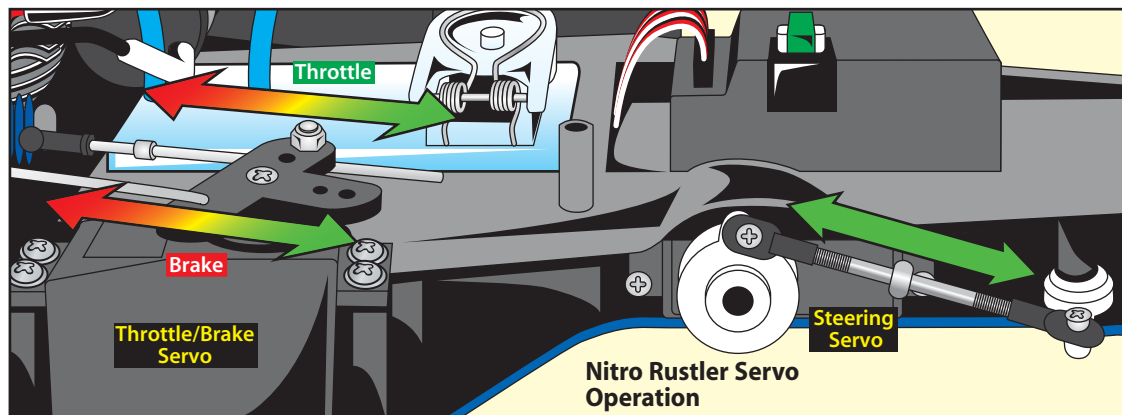

! When the engine is running, don't use the throttle trim on the transmitter to adjust the engine idle speed. Instead, use the idle speed adjustment on the carburetor.



Don't attempt to operate your Nitro Rustler if there are any problems with your radio system or radio interference at your location.

Range-Testing the TQ Radio System

Before each running session with your Nitro Rustler, you should range-test your radio system to ensure that it operates properly.

1. Turn on the radio system and check its operation as described in the previous section (Using Your Radio System, pages 18- 19).
2. Have friend hold the model with the engine off.
3. Make sure your transmitter antenna is fully extended, and then walk away from the model with the transmitter until you reach the farthest distance you plan to operate the model.
4. Operate the controls on the transmitter once again to be sure that the model responds correctly.
5. Do not attempt to operate the model if there is any problem with the radio system or any external interference with your radio signal at your location.

Centering the Servos

Whenever your radio system has been removed for service or cleaning, the servos must be re-centered prior to installing the radio system in the model. If the radio system is installed in the car, disconnect the servo horns from the servos.

Connect the steering servo to channel 1 on your receiver and the throttle servo to channel 2. The white wire on each servo cable is positioned towards the crystal. Connect the red and black cable from the battery holder to the "batt" terminal on the receiver. The red wire is positive and the black wire is negative.

Place fresh "AA" batteries in the transmitter and turn the power switch on. Slide the throttle and steering trim adjustments to to the center position. Now install fresh "AA" batteries into the

battery holder and turn the power switch to the on position. The servos will automatically jump to their center positions.

Turn off the battery holder switch followed by the transmitter. The servos are now ready to be installed. Be careful not to move the servo shaft when reinstalling the servo horns.

The TRX 2.5 Racing Engine™

Introduction

There's nothing like the TRX 2.5 Racing Engine in your new Nitro Rustler. The TRX 2.5 racing engine is vastly superior to typical R/C engines and belongs in the category of specialty high-performance racing engines. It's the result of years of focused engineering development, and thousands of hours of controlled testing and rigorous real-world running. It offers unprecedented power and performance that turns ready-to-run into Ready-To-Race®.

The TRX 2.5 racing engine takes a total-system approach. Each part of the engine, from the air filter to the exhaust tip, is carefully engineered to work in harmony with other engine components. Each part complements the next, to extract maximum power. The TRX 2.5 is designed to be tolerant of variations in tuning, and to run successfully through a wide range of variable atmospheric conditions, such as changes in temperature, humidity, and altitude.

The TRX 2.5 is manufactured to exacting tolerances and requires a specially-designed break-in procedure to accomplish the final precision fitting of the internal engine components. It is very important that you follow the new break-in procedure as closely as possible to achieve the best performance and longest life from your TRX 2.5 racing engine. Old style break-in procedures, such as simply running the engine with a very rich fuel mixture for the first 4 tanks of fuel, will not achieve the best results. Follow the steps in this manual.

A routine maintenance schedule is also required to keep the TRX 2.5 in top running condition. Cleaning the air filter after each hour of running is particularly important. Also it is extremely important to perform after-run maintenance on the engine to prevent corrosion from building up on the internal engine components (see page 42).

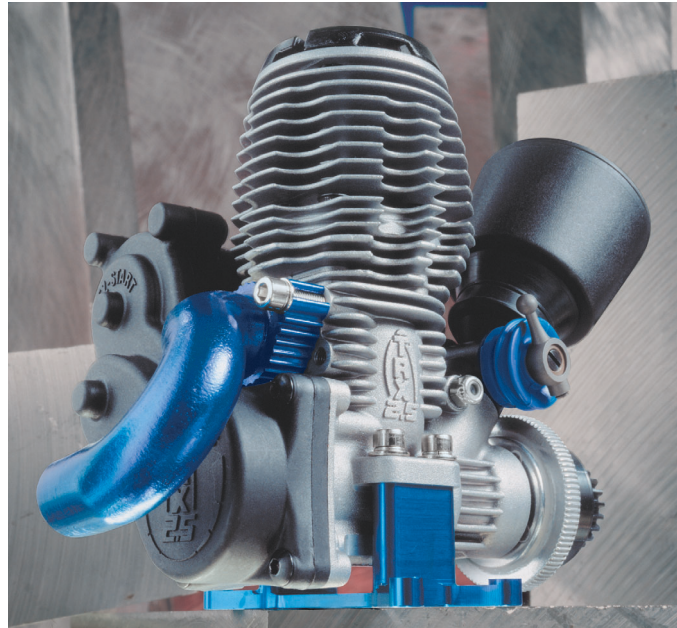

 Traxxas strongly discourages changing or modifying any part of the TRX 2.5 racing engine. Old tech tips and tricks that may have boosted the power of other engines could seriously diminish the performance of the TRX 2.5.

There's more advanced thinking, development and testing in the stock parts of your TRX 2.5 than in many aftermarket manufacturer's so-called performance parts. The TRX 2.5 is already one of the most powerful engines in its class and simply will not benefit from average, low-tech, aftermarket bolt on performance items.

TRX 2.5 Illustrated

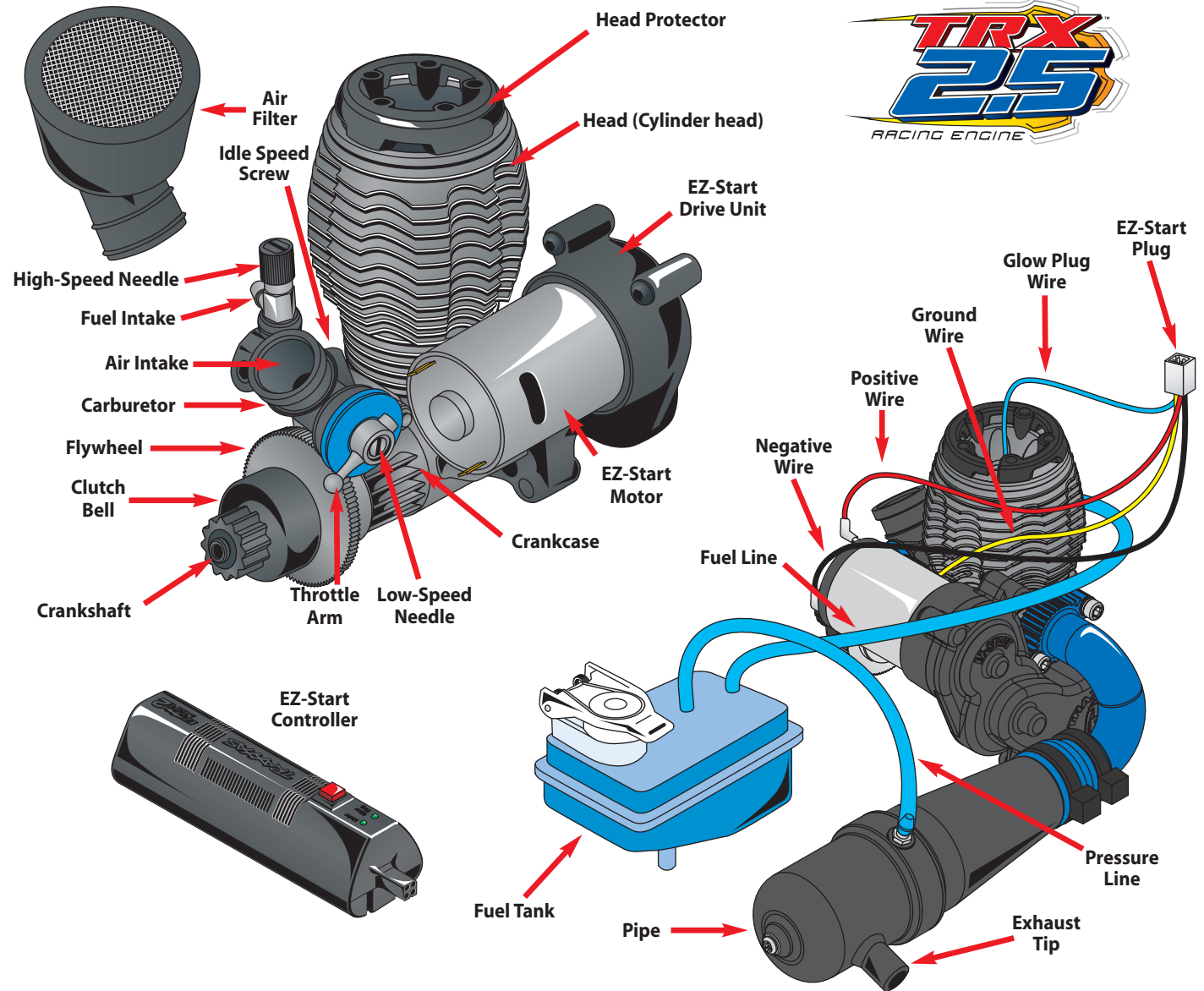

Terms to Know

You'll find these Nitro R/C engine terms throughout this section of the manual.

.15 - .15 or "15" refers to the size of the engine. The TRX 2.5 is .15 cubic inches or 2.5 cubic centimeters (cc). The name "TRX 2.5" is derived from the cc measurement.

ABC - Abbreviation for aluminum, brass, and chrome. Refers to engine construction that consists of an aluminum piston that slides in a chrome-plated brass sleeve. The TRX 2.5 uses ABC construction.

Air filter - The air filter sits atop the carburetor and prevents harmful dust and dirt from entering the engine. Dirt ingestion is the number one cause of premature engine failure so the engine should never be run without the air filter in place.

Big Block .15 - A .15 (2.5) engine that uses a larger crankcase size and longer stroke than typical .15 engines. Generally only used for specific racing classes.

Break-in - Break-in is the procedure for running a brand new engine according to specific instructions. This correctly prepares the engine for normal running. The break-in procedure can be different for different makes of engines. Follow the Traxxas directions for break-in exactly.

Carb - Abbreviation for carburetor.

Carburetor - The carburetor atomizes (mixes) the fuel with the air so that the engine can burn it. There are two types of carburetors, slide carbs and barrel carbs. The TRX 2.5 uses the superior slide carburetor design.

Clean-out - Cleaning-out is a condition that occurs when the engine is accelerating and the fuel mixture becomes sufficiently lean to allow the engine to continue into its upper RPM power band. Usually characterized by a noticeable decrease in blue exhaust smoke and a dramatic increase in engine speed.

Combustion chamber - The combustion chamber is machined into the bottom of the cylinder head. This is where the glow

plug ignites the fuel. The shape of the combustion chamber is designed to promote more efficient burning of the fuel.

Connecting rod - The connecting rod transfers the piston motion to the crankshaft. The TRX 2.5 racing engine uses a "knife-edged" connecting rod. The aerodynamic, sharpened edges allow it to "slice" through the pressurized air/fuel mixture inside the crankcase.

Cooling fins - The cooling fins are molded into the cylinder head and crankcase and cause heat to be drawn away from the engine. Heat is removed when it dissipates into the air passing across the cooling fins. It is important to keep the fins clean of dirt and debris for maximum cooling efficiency.

Crankcase - The engine "body" that contains all of the running mechanical components.

Crankshaft - The main shaft of the engine that contains the rotating assembly.

Cylinder head (head) - The finned aluminum part on top of the engine that is responsible for dissipating most of the engine's heat. The combustion chamber is machined into the bottom of the head.

Dyno - Abbreviation for dynamometer. A precise piece of testing equipment that accurately measures engine power and torque output over the engine's entire RPM range.

EZ-Start - Second generation Traxxas on-board electric starting system. The system consists of a hand held starter control unit and an on-board gearbox with an electric motor to spin the engine. The new EZ-Start contains many performance and reliability improvements over the first generation EZ-Start.

Filter foam - The oiled foam element inside the air filter housing. The filter foam in the TRX 2.5 must be thoroughly cleaned and re-oiled after every hour of run time.

Fit - Usually refers to the fit of the piston and sleeve. If the fit is tight, then the piston will feel very tight at top of the sleeve and the engine will have good sealing and compression. If the fit is loose, then compression will be low and the piston and sleeve should be replaced.



Learn terms related to the TQ Radio System on page 12.

Flame-out - Occurs when the engine stops running at high RPM. Usually the fault of an excessively lean fuel mixture or glow plug failure.

Fuel - (10% 20%) The TRX 2.5 must have model engine fuel to run. Traxxas Top Fuel is recommended. Fuel is sold in quarts and gallons from hobby dealers. The 10 and 20% labeling refers to the percentage amount of nitromethane contained in the fuel (*see "nitro percentage" definition*).

Fuel mixture - The ratio of fuel to air as determined by the needle settings of the carburetor.

Fuel tubing (fuel line) - The thick silicone tubing that carries fuel from the fuel tank to the carburetor.

Glow plug - The glow plug is located in the cylinder head at the top of the combustion chamber. It contains a platinum element that glows red hot when voltage is applied. When the engine is being started, the heat from the glow plug ignites the fuel mixture and starts the combustion process.

Glow plug driver - This tool clips onto the glow plug and supplies the required voltage to light the glow plug element. It is also called an igniter. EZ-Start equipped engines do not require this separate tool.

Header - The aluminum tube that connects the exhaust system to the engine exhaust port. The length and diameter of the header must be carefully selected to extract the most power from the engine.

High-speed needle - Adjusts the carburetor's fuel/air mixture at high RPM.

Idle speed - The speed (RPMs) the engine runs at when the transmitter's throttle trigger is at neutral.

Idle speed screw - Located on the carburetor body. This screw adjusts the idle RPM of the engine.

Lean - A running condition where the engine is not getting enough fuel (for the available air). Symptoms include engine overheating, or the engine runs for a short time and then

stalls, particularly at high speed. This is a dangerous condition that should be corrected immediately or it can ruin your engine.

Leaning the mixture - Turning either the high speed and/or low-speed needle(s) clockwise to decrease the amount of fuel the engine receives.

Low-speed needle - Needle valve that controls the low-speed fuel mixture.

Needle valve - Valve consisting of a tapered needle that closes against a corresponding seat to regulate fuel flow.

Nitro - Abbreviation for nitro methane, a component of model engine fuel that improves fuel combustion and power output. Nitro also refers to a class of RC powered by model engines instead of electric.

Nitro content - The amount of nitro methane used in the fuel. Usually measured as a percentage of the total fuel volume. Traxxas engines are optimized to use 10-20% nitro. 30% nitro may be used for racing.

Nitromethane - Nitro methane is a component in the fuel that increases power from the combustion process up to a point. Engines are generally optimized to use a range of nitro content for the best power.

O-ring - Rubber "O"-shaped ring used as a sealing gasket.

Pipe - Abbreviation for the tuned exhaust pipe on a nitro engine. *See "Tuned Pipe" definition*.

Piston - The piston is the internal engine part that is attached to the upper end of the connecting rod and moves up and down in the cylinder sleeve. The precise fit between the piston and the sleeve creates a seal that allows engine to have the required compression for combustion.

Port - Ports are openings in the sleeve that allow atomized fuel to enter the combustion chamber and burned exhaust gasses to exit. The shape and location of the ports are a large factor in controlling the engine timing and power output.



Priming - Manually causing fuel to move from the fuel tank up to the carburetor. This is sometimes necessary after the engine has been sitting for a long period of time and all the fuel has drained back to the tank. On a Traxxas model this is done by holding your finger over the exhaust tip for one or two seconds while the engine is starting.

Punch - A term that refers to how quickly the model responds to throttle input or how quickly it accelerates.

Rich - A running condition where the engine is getting too much fuel for the available air. It is better to run an engine slightly rich to increase engine life. Excessively rich mixtures cause the engine to have sluggish performance with exaggerated blue smoke and unburned fuel coming from the exhaust.

RPM - Abbreviation for revolutions per minute (how many times the engine crankshaft spins in a minute).

Sleeve - Internal engine part that contains the piston. The precise fit between the sleeve and the piston creates a seal that allows engine to have the required compression for combustion. The sleeve in a TRX engine is made of brass and is then hard-chrome plated.

Slide carburetor - The throttle on a slide carburetor closes and opens by sliding a barrel in and out of the carburetor body. This type of carburetor is preferred for performance use because it provides a less restrictive "straight-through" air path than the barrel carburetor design.

Stall - When the engine stops running, usually due to an incorrect fuel mixture setting or running out of fuel.

Tuned pipe - The tuned exhaust pipe usually consists of a specially-shaped metal or composite chamber with baffles that is designed to enhance the power output of the engine.

Wear-in - Fitment process that occurs during engine break-in where internal engine parts develop an even more precise matched fit through actual use under controlled circumstances.

WOT - Abbreviation for wide-open throttle.



You may use higher nitro percentages than 20% in certain circumstances. Call 1-888-TRAXXAS for more information.

The Fuel

Use the Right Fuel

It's imperative that you use the correct fuel in your TRX 2.5 for maximum performance and engine life. Traxxas Top Fuel should be used to ensure correct engine lubrication, performance, and ease of tuning. Traxxas Top Fuel™ has been proven in thousands of engines, so you can count on it every day for great performance.



- ▶ Top Fuel is the only fuel which is 100% certified for use in Traxxas engines.
- ▶ Traxxas Top Fuel is made with just the right balance of the highest grade natural and synthetic lubricants to allow excellent throttle response and the best top-end performance, without sacrificing long-term durability.
- ▶ All of the components in the fuel are carefully selected from the best materials available and then custom blended to match the metallurgy and temperature characteristics of Traxxas engines.

You may use 10% or 20% nitro-content fuel. Use the same percentage all the time; don't switch back and forth between 10% and 20% fuel. If you break-in your engine on 20% fuel, then always use 20% fuel.

What about Other Fuels?

Can other brands of fuel be used besides Top Fuel? There are other fuels that can provide satisfactory performance; however there could be long-term costs in the form of decreased engine performance, loss of tuning ease, and shorter engine life.

Everyone has an opinion or a claim to make about fuel. The engineering team at Traxxas spent over 2-years developing the TRX 2.5 racing engine. No one knows more about the specific fuel requirements of Traxxas engines than Traxxas engineers. We strongly urge you not to take chances with your engine investment and use the Traxxas fuel made for the TRX 2.5.

Handling the Fuel

- ▶ Follow all directions and warnings on the fuel can.
- ▶ Keep the fuel tightly capped at all times. Some components in the fuel can evaporate very quickly and upset the balance of the fuel.
- ▶ Do not store unused fuel in the fuel dispenser. Immediately return fresh unused fuel back into the fuel can.
- ▶ Do not mix old and new fuel. Never mix different brands of fuel together.
- ▶ Store the fuel in a cool dry location, away from any source of heat, ignition, or combustion.
- ▶ Read and follow the safety precautions on page 5 in this manual.

Filling the Fuel Tank

Use a fuel dispensing bottle (Traxxas Top Fueler, part# 5001) to put fuel into the Nitro Rustler's fuel tank. To fill the fuel bottle, squeeze the air out, insert the dispenser tip into the fuel can, and release your grip on the bottle. As the bottle expands, fuel will be drawn into it.



To fill your model flip up the spring-loaded cap on the fuel tank, insert the tip of the fuel bottle, and squeeze to dispense the fuel. Fill the tank until the fuel level reaches the base of the filler neck. Close the fuel tank lid, making sure it closes tightly.

The Air Filter

The TRX 2.5 air filter is carefully designed to deliver maximum performance while protecting your engine from dust and dirt. Use only the supplied filter. **You will not improve engine performance by switching to an aftermarket filter**, and you may risk engine damage due to poor filtration.

The TRX 2.5 air filter assembly consists of 3 pieces:

1. A rubber filter base
2. A plastic housing consisting of a permanently assembled mesh cap and body
3. An oiled foam element

You must clean the filter after every hour of runtime, **even if the filter looks clean**. Dust (which is often too fine to see) and dirt constantly move through the filter anytime the engine is running. Even if you can't see dirt on the filter, it is present inside the foam after any amount of runtime. If you exceed the recommended cleaning intervals, your engine will be damaged. Engine damage or wear due to dirt ingestion is easy to detect, and one of the top causes of premature engine failure.

Air Filter Cleaning Instructions

1. Remove the air filter from the carburetor bore by pulling the entire filter firmly to the side to release it. Do not pull straight up.
2. Disassemble the filter. Pull the rubber base out of the filter body. With the base removed, the foam element is visible in the bottom of the filter body. Pull out the foam element.

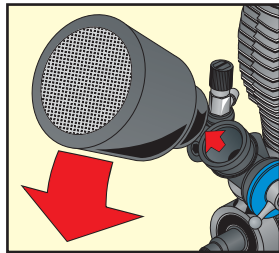

3. Clean the filter parts by thoroughly washing all three pieces of the filter assembly in hot soapy water (dishwashing detergent works well). Repeat twice.
4. Thoroughly dry the parts with a clean towel or compressed air. Remember to wear your safety glasses when working with compressed air.
5. Oil the foam element by saturating it with foam filter oil. Use the supplied Traxxas filter oil (part# 5263) or a high-quality, special-purpose foam filter oil like what is used for high-performance motorcycle and ATV engines. This type of filter oil is available at motorcycle pro-shops. If foam filter oil is not available, clean 30-40 weight motor oil can be substituted, but is not preferred. **Never run the engine without a properly oiled filter!** Apply 30 drops of the Traxxas filter oil evenly to the top, bottom and sides of the filter element (30 total drops divided among the 3 surfaces). Squeeze the filter element repeatedly to help spread the oil throughout. Squeeze the excess oil from the foam. The filter element should be evenly colored by the oil. Even color indicates that the oil is evenly distributed. **Note: Do not use the air filter oil for anything other than the air filter. It is not meant to be a lubricant.**
6. Reassemble the filter and install it on the engine, making sure the rubber base fits securely on the carburetor with no gaps or air leaks.

 Clean your air filter after every hour of runtime to avoid engine damage, even if the filter looks clean.

 If you use compressed air to dry your air filter assembly, wear safety glasses and avoid directing compressed air toward your skin.



See page 35 for more information on how air density affects engine tuning.

The Carburetor

Understanding the Carburetor adjustments

The carburetor performs several functions. It controls the engine's speed by restricting the intake of air and fuel into the engine. It atomizes the fuel (suspends the fuel droplets in the air) and also controls the air/fuel ratio of the mixture entering the engine (how much air for a given amount of fuel).

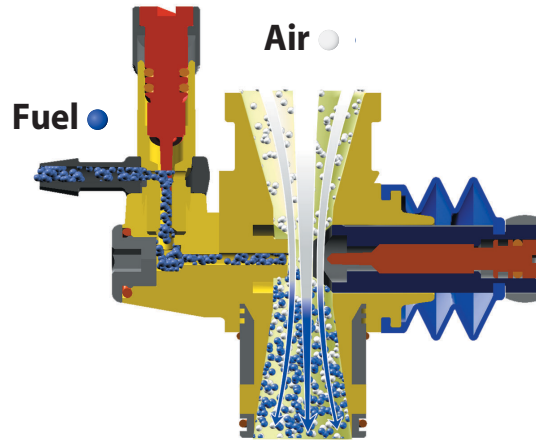

To help provide a better understanding of engine tuning and why it's necessary, the following is a brief explanation of the air/fuel combustion process that takes place inside the engine.

In order to create the cylinder pressure that results in power, the engine burns the air/fuel mixture. Both air and fuel, in correct amounts, are needed for proper combustion. It is the carburetor's job to mix the air and fuel together (atomize the fuel), in the correct proportion for the best possible combustion. This is the ideal air/fuel ratio. The ideal air/fuel ratio required for the engine remains roughly constant. Due to variations in atmospheric conditions (temperature, humidity, altitude etc.) fuel flow adjustment valves (called fuel mixture needles) are required to meter the fuel and maintain the ideal air/fuel ratio in these ever-changing conditions. For example, colder air is more dense (more air molecules) for a given volume of air and therefore requires more fuel (more fuel molecules) to maintain

the correct air/fuel ratio. Warmer air is less dense (fewer air molecules) and therefore needs less fuel to maintain the correct air/fuel ratio. The tuning needles are there to adjust how much fuel is made available for the carburetor to mix with the available air (atomization).

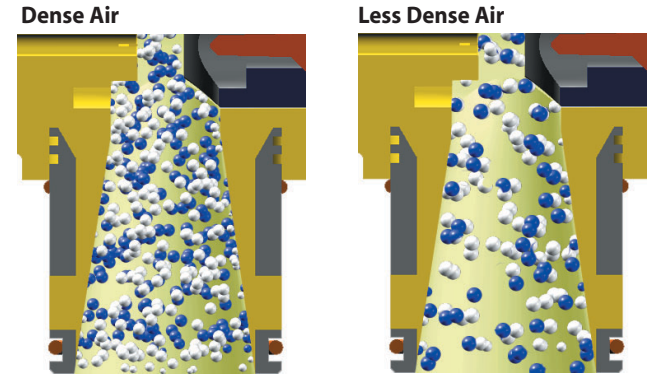

The Fuel Mixture Needles

The amount of fuel metered and atomized by the carburetor is controlled by the two mixture needles, the high-speed needle and the low-speed needle. The low-speed needle is used to meter the fuel used by the engine at idle and low RPM (part-throttle) engine speed. The high-speed needle is used to meter the fuel when the throttle is open from part throttle to wide-open throttle (WOT). Two needles on the TRX 2.5 provide precise control of the air/fuel ratio across the engine's entire RPM range.

The maximum possible fuel flow is always controlled by the high-speed needle. It works like the main water valve on a garden hose. Turn it clockwise to close the valve, counter-clockwise to open it. When the throttle is at idle or partially open, the low-speed needle again meters the fuel flow at the outlet (needle seat) where the fuel enters the carburetor venturi. This second valve acts like the spray nozzle at the end of the garden hose in our example. When you accelerate from idle, the throttle opens and the low-speed needle is pulled away from the needle seat. This allows more fuel to flow with the increased air flow. As the throttle is increased, the low-speed needle is

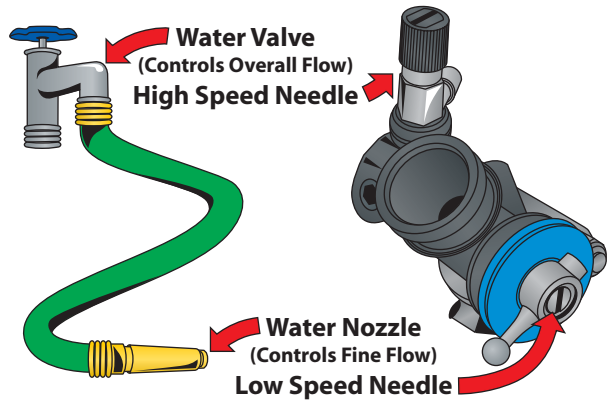

- ▶ Slightly lean fuel mixtures deliver stronger, more efficient combustion and more power, but with less lubrication.
- ▶ Slightly rich fuel mixtures deliver cooler running and more lubrication but with slightly less power.

Tuning the engine means finding the perfect balance between the two; excellent power to meet your needs while maintaining good lubrication for long engine life. **The optimal fuel mixture setting is rich** to provide a safety margin against having a lean condition if some variable changes (such as the temperature from one day to the next).

General fuel mixture settings are measured by the number of turns the needles are turned out from fully closed. The fuel mixture settings have been pre-set from the factory to typical break-in settings. Do not readjust your carburetor from the factory settings until after the engine is started and running, and you have been able to observe the engine running to assess what minor adjustments may be required to compensate for fuel, temperature, and altitude. Adjustments are usually made in 1/8 or 1/16-turn increments.

The Idle Speed Adjustment

The idle speed screw controls the closed position of the throttle slide. When the throttle servo is in its neutral position, the throttle slide should be stopped against the idle adjustment screw. Always use the idle speed adjusting screw to control engine idle. Do not use the throttle trim on the transmitter to adjust idle speed. The idle speed should be set as low as possible and still maintain reliable running.

pulled completely away from the needle seat leaving it fully open. At that point, fuel metering is entirely controlled by the high-speed needle. Again, using our water hose example, when the spray nozzle at the end of our garden hose is fully open, then the main water valve can be used to adjust how fast the water flows.

The engine's performance is directly linked to the fuel mixture. Richening the fuel mixture increases the amount of fuel in the air/fuel mixture ratio and leaning the fuel mixture decreases the amount of fuel in the air/fuel mixture ratio.

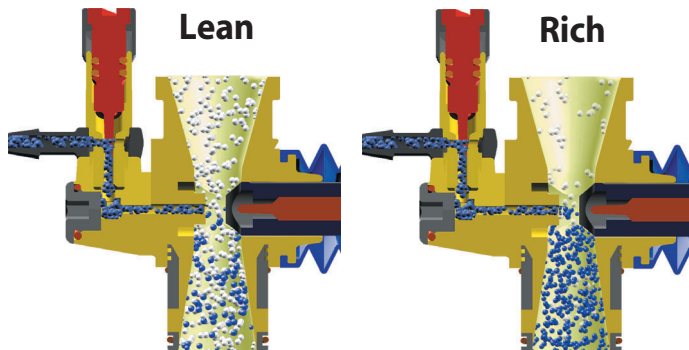

➔ See *Tuning the TRX 2.5 for Best Performance* on page 34 for complete information on adjusting the air/fuel mixture and idle speed.

💡 If your factory preset carburetor adjustments have been tampered with, use the following settings: set the low-speed needle so that the screw head is flush with the end of the slide. Set the high-speed needle to 4 turns out from closed. Always use the factory settings for initial starting. Only use these settings when the factory settings have been lost.



Use the Right Charger

The most convenient type of charger is an AC peak-detecting charger that plugs directly into an AC wall outlet. It contains special peak-detection circuitry that automatically shuts the charger off when the battery is fully charged.

If you're using a 15-minute timed charger, always fully discharge the battery pack before each charge. Some high mAh battery packs (1500 mAh or higher) require more than the standard 15 minutes of charge time. If the battery pack is cold after 15 minutes of charging, add another 5 minutes of charge time. Closely monitor the battery pack and stop charging it when it begins to feel warm to the touch. Never leave a battery charging unattended. Always follow charger manufacturer's instructions.

The Traxxas EZ-Start Electric Starting System

The Traxxas EZ-Start brings the convenience of push-button electric engine starting to your Nitro Rustler. The EZ-Start consists of a handheld control unit and an on-board motorized starter.

- ▶ Power for the EZ-Start system comes from a 7.2-volt rechargeable NiCad battery pack installed in the handheld control unit (battery not included).
- ▶ The engine glow plug is heated automatically by the EZ-Start system, eliminating the need to keep up with a separate glow plug igniter.
- ▶ The voltage to the glow plug is kept constant, regardless of the load placed on the starter by the starter motor.
- ▶ The "Glow Plug" LED (light emitting diode) on the control unit indicates the condition of the glow plug.
- ▶ The "Motor" LED indicates the status of the EZ-Start electric starter motor.
- ▶ The cush drive mechanism in the drive unit prevents damage to the gears caused by engine kickback.
- ▶ Smart Start™ protection circuitry prevents damage to the motor by cutting power if the load on the motor or other electronics exceeds safe limits.

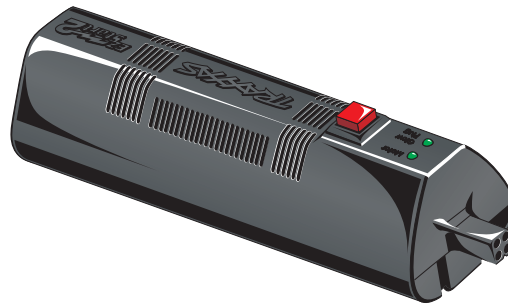

Installing the EZ-Start Battery

The EZ-Start system requires a fully charged 7.2-volt NiCad battery pack (not included). Use a charger (not included) designed for 7.2-volt battery packs. Charge the battery according to the charger manufacturer's directions.

1. Press the tab in the end of the battery compartment door to open
2. Plug a fully charged 7.2-volt NiCad battery pack into the connector inside.
3. Twist the battery 2 or 3 times to twirl the battery plug wires. This helps hold the wire and battery in place when the battery is installed in the compartment
4. Place the battery into the compartment and press the wires securely into place.
5. Slide the battery compartment door back on and lock the end tab.

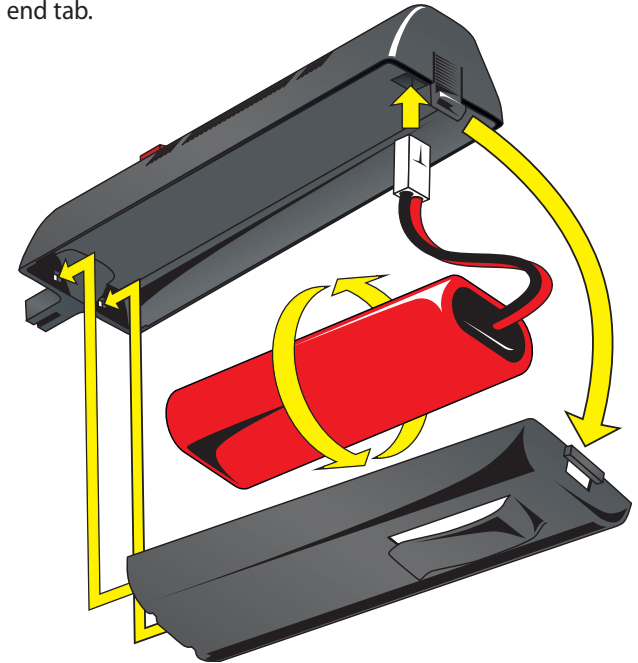

Using the EZ-Start

Your EZ-Start controller plugs into a 4-prong receptacle mounted on the battery box of your Nitro Rustler. When the red button on the controller is depressed, the EZ-Start motor begins to spin the engine, and power from the control unit heats the glow plug. Assuming all settings and preparations are correct, the engine should start almost immediately.

Each of the two status indicator LEDs on the handheld control unit, the **Motor** LED and the **Glow Plug** LED, should light green while starting. If either LED fails to light while starting, there is a fault indicated with that function:

- ▶ If the **Glow Plug** LED fails to light, the glow plug may be bad, or the glow plug wire may be damaged or disconnected.
- ▶ If the **Motor** LED fails to light and the starter fails to operate, then the EZ-Start is in protection mode.

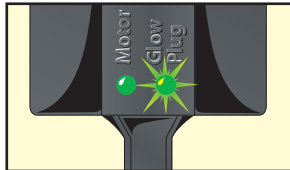
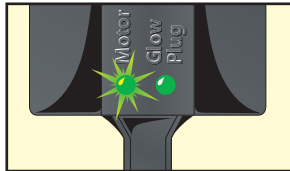
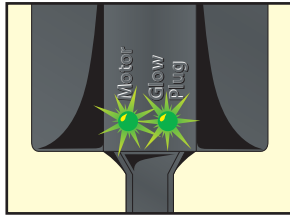

Protection Mode

The EZ-Start uses Smart Start™ technology to monitor the condition of the system and detect failures. The controller monitors the load being placed on the EZ-Start motor. If the load becomes excessive, the system shuts off power to the motor to prevent costly damage to the motor and the controller. This may occur, for example, if the engine floods with fuel during starting. The starter spins at first but when excessive fuel in the combustion chamber begins to lock up the engine, the starter motor slows under the heavier load. This causes the protection circuit to shut off the power to the motor. Allow at least 3 minutes for the starter motor to cool and the circuit to automatically reset before continuing. Use the time to find and eliminate the condition that caused the excessive load on the starter motor.

 When the EZ-Start controller is in protection mode, wait at least three minutes before attempting to start the engine, to give the starter motor time to cool.

 It's normal for your EZ-Start controller to become warm after repeated use.

 See page 43 for information on clearing a flooded engine.



See *Important Points to Remember* on page 5 for other precautions.



Never run your Nitro Rustler indoors. Since the

TRX 2.5 racing engine exhaust fumes are harmful, always run your Nitro Rustler outdoors, in a well-ventilated area.



Your TRX 2.5 racing engine doesn't usually require

priming. If you do need to prime your engine, watch the fuel line carefully to avoid flooding your engine. See page 43 for information on clearing a flooded engine.



Your carburetor is pre-set at the factory to give the

correct air-to-fuel ratio and idle speed for engine break-in. Do not adjust the carburetor unless you observe a poor running condition that requires correction.

Breaking-in Your TRX 2.5 Racing Engine

The TRX 2.5 uses a ringless, aluminum-brass-chrome (ABC) piston/sleeve construction. This type of engine design relies on a very precise running fit between the piston and sleeve for cylinder sealing. **Engine break-in is necessary to allow the piston and sleeve to develop an extremely precise fit and optimum cylinder sealing. Therefore, proper engine break-in is critical to achieving the fastest, most reliable engine performance.**

Allow yourself about 1 to 1½ hours to complete the break-in procedure. The engine break-in period will take 5 tanks of fuel in a Nitro Rustler. The break-in time is not the time to impress your friends with your new Nitro Rustler. **You must wait until the engine is fully broken in before attempting sustained high speed running.** Patience and careful attention during break-in will reward you with the best-performing TRX 2.5 possible.

During break-in, your engine may appear to malfunction with symptoms like stalling, inconsistent performance, and fouled glow plugs. These are simply the normal "break-in pains" engines sometimes go through. They will disappear once your engine is fully broken in. Many owners report not experiencing any of these symptoms with the TRX 2.5. **We recommend replacing the glow plug with a new one after the engine break in procedure.**

Engine Break-in Procedure

The focus during break-in is to vary and limit the engine speed. This will be accomplished by accelerating and stopping at different rates for the first 5 tanks of fuel. As the engine begins to break-in, the duration and intensity of the acceleration will gradually increase. **Sustained high-speed running is not permitted until the 6th tank of fuel.** Perform the initial break-in on a large, flat, paved surface. **Apply all throttle and braking actions gently. Abrupt acceleration or braking could cause the engine to stall unnecessarily.**

- ▶ Special break-in fuels are not recommended. Use the same fuel you plan to use everyday.
- ▶ If possible, avoid breaking-in the engine on extremely hot or cold days.
- ▶ Pay careful attention to the fuel level. Do not allow the fuel tank

to run completely empty. An extremely low fuel level causes the mixture to run too lean. This could result in a burned glow plug or extremely high engine temperatures.

- ▶ Keep extra glow plugs handy (Traxxas part #3231). The break-in process can cause deposits to form on the plug leading to plug failure.

Follow the instructions exactly for each of the first 6 tanks of fuel.

Starting Your TRX 2.5 Racing Engine for the First Time

Before you start your TRX 2.5 racing engine for the first time, make sure you have read all instructions and precautions in this manual. **Pay close attention to the tank-by-tank break-in instructions in the next section, and make sure you have read and understood them before you run your engine.**

Your engine must be at room temperature (70°F or 21° C) or above the first time you start it. If it's cooler than room temperature outside, keep your Nitro Rustler indoors until you're ready to start it, then take it outside.

1. Turn on the radio system according to the instructions on pages 18 and 19.
2. Make sure the throttle is in the idle position.
3. Connect the EZ-Start controller according to the instructions on page 31.
4. Press the starter button and watch for fuel moving through the fuel line up to the carburetor. Watch closely! The fuel moves very fast. If the fuel doesn't move through the line within 5 seconds, prime the engine by briefly (one or two seconds) covering the exhaust outlet until the fuel is just visible in the carburetor fuel line. **Watch carefully! If the engine is primed too long, it will flood with fuel and stop turning.**
5. Once fuel reaches the carburetor, the engine should quickly start and idle.
6. Disconnect the EZ-Start controller from the model.
7. Proceed with the engine break-in.

If your engine doesn't start, see *Troubleshooting Your Nitro Rustler* on page 39.

Tank 1

1. Drive the model with the **body off**.
 2. Driving procedure: **Gently pull the throttle trigger to 1/4 throttle over a 2-second count. Then gently apply the brake to stop.** Count the two seconds out while accelerating: one thousand one, one thousand two, and then stop. Operate the throttle trigger as smoothly as you can. **Repeat this starting and stopping procedure until the first tank of fuel is nearly empty.**
 3. Look for thick blue smoke exiting the exhaust outlet. If there is no smoke, richen the high-speed needle 1/4 turn, by turning the needle counterclockwise.
 4. When the fuel tank is nearly empty, shut off the engine by pinching the fuel line connected to the carburetor.
 5. Let the engine cool for 15 minutes.
- Note: If at any point the engine cuts out or stalls during gentle acceleration, richen the high-speed needle 1/4 turn by turning the needle counterclockwise.

Tank 2

1. From tank 2 forward, the Nitro Rustler should be driven **with the body on**.
2. Driving procedure: **Gently pull the throttle trigger to 1/2 throttle over a 2-second count. Then gently apply the brake to stop.** Count the two seconds out while accelerating: one thousand one, one thousand two, and then stop. **Repeat this starting and stopping procedure until the second tank of fuel is nearly empty.**
3. When the fuel tank is nearly empty, shut off the engine and let it cool for 15 minutes.

Tank 3

1. Driving procedure: **Gently pull the throttle trigger to 1/2 throttle over a 3-second count. Then gently apply the brake to stop.** Count the three seconds out while accelerating: one thousand one, one thousand two, one thousand three, and then stop. **Repeat this starting and stopping procedure until the third tank of fuel is nearly empty.**
2. As the engine loosens, the idle speed may increase and cause the model to try to creep forward when stopped. Reduce the idle

speed by turning the idle adjustment (see page 22) on the carburetor counterclockwise.

3. When the fuel tank is nearly empty, shut off the engine and refuel. From here on, you do not need to let the engine cool between tanks.

Tank 4

1. Driving procedure: **Gently pull the throttle trigger to full throttle over a 3-second count. Then gently apply the brake to stop.** Count the three seconds out while accelerating: one thousand one, one thousand two, one thousand three, and then stop. **Repeat this starting and stopping procedure until the fourth tank of fuel is nearly empty.**
2. Apply the throttle gradually! Your finger should not reach full throttle until the end of the three-second count.
3. Keep your driving smooth and consistent.
4. When the fuel tank is nearly empty, shut off the engine and refuel.

Tank 5

1. Driving procedure: **Gently pull the throttle trigger to full throttle over a 3-second count, hold for 2 more seconds, and then gently apply the brake to stop.** Count the five seconds out while accelerating. **Repeat this starting and stopping procedure until the fifth tank of fuel is nearly empty.**
2. When the fuel tank is nearly empty, shut off the engine and refuel.

Tank 6

During the sixth tank of fuel, the engine can be tuned for general performance use. Proceed to the next section in this manual.

Tank	Throttle	Time	Cool	Body	Notes
1	1/4	2 Seconds	15 Minutes	Off	Apply throttle gradually.
2	1/2	2 Seconds	15 Minutes	On	Apply throttle gradually.
3	1/2	3 Seconds	-	On	Reduce idle speed if necessary.
4	Full	3 Seconds	-	On	Keep your driving consistent.
5	Full	5 Seconds	-	On	Accelerate over 3 second count, hold for 2 seconds.



As you gain experience in the hobby, you may discover that many people have differing opinions on what is the proper procedure to break-in a model engine. *Only use the Traxxas break-in procedure.* Other break-in procedures could result in a weak, damaged, or otherwise poor performing engine. The procedure outlined here was extensively tested and proven to yield better performing engines than other "common" break-in methods. Even if you have years of experience using model engines, please do not ignore this caution!



When adjusting the low-speed fuel mixture, it is very important to make several high-speed runs with the Nitro Rustler between adjustments to clear out any excess fuel. Perform the pinch test immediately after. If the engine is allowed to idle for a long period of time, it could “load up” with fuel and give you an inaccurate measurement from your pinch test.



For your convenience, the low-speed needle has a positive stop that prevents it from being over tightened and damaging the needle and seat. This also provides an easy way to gauge how many turns out from closed the low-speed needle adjustment is set to.



When tuning for performance, watch closely to notice when there is no longer any increase in speed or power when the high-speed mixture is lean. If you lean the high-speed mixture to the point that the engine cuts-out, hesitates, or stalls, you are well into the danger zone and engine damage is likely. Richen the high-speed needle 1/4 turn and retune.

Tuning the TRX 2.5 for Best Performance

The engine’s performance depends on the fuel mixture. Turn the mixture needles clockwise to lean the fuel mixture and counterclockwise to richen it. Leaning the fuel mixture will increase engine power up to the engine’s mechanical limits. **Never run the engine too lean (not enough fuel flow). Never lean the engine until it begins to cut-out or stall. Leaning the engine beyond the safe allowable limits will result in poor performance and almost certain engine damage.** Indications of an overly lean mixture include:

- ▶ Cutting out or sudden loss of power during acceleration.
- ▶ Overheating (temperature beyond 270° F at the glow plug)
- ▶ Little or no blue smoke coming from the exhaust.

If any of these conditions are present, stop immediately and richen the high speed mixture 1/4 turn. The engine will probably be slightly rich at that setting and you can then retune for performance. Always tune for performance by starting rich and moving leaner toward the ideal setting. Never try to tune from the lean side. There should always be a light stream of blue smoke coming from the exhaust.

Before you begin tuning, the engine should be warmed up to its normal operating temperature and running slightly rich. All final tuning adjustments must be made to the engine at its normal operating temperature. You can tell the engine is running rich by noting any of the following:

- ▶ Sluggish acceleration with blue smoke coming from the exhaust.
- ▶ There is unburned fuel spraying from the exhaust tip
- ▶ Leaning the high-speed fuel mixture increases performance

High-Speed Fuel Mixture Adjustment

With the engine warm and running at a rich setting, gradually lean the high-speed fuel mixture in 1/16 turn increments. Make several high-speed passes with the Nitro Rustler after each adjustment to clear out the engine and note any change in performance. The TRX-2.5 is extremely powerful. Remember to apply the throttle gradually to prevent wheelies or loss of

control. Continue this procedure until one of the following conditions exist:

1. There is no longer any performance improvement
2. The engine begins to cut out at high speed (**Danger!**)
3. There is a sudden loss of power during acceleration (**Danger!**)
4. The engine begins to overheat. Symptoms of overheating include:
 - ▶ Steam or smoke coming from the engine (not exhaust)
 - ▶ Hesitation or stalling during acceleration
 - ▶ Popping or clattering sound when decelerating (detonation)
 - ▶ Fluctuating idle speed
 - ▶ Temperature measurement above 270° F at the glow plug

If any one of the above conditions occurs, the fuel mixture is already past the maximum safe lean setting. Richen the fuel mixture to the optimum setting by richening the high-speed needle at least 1/8 turn counterclockwise and retest. This setting will extend engine component life.

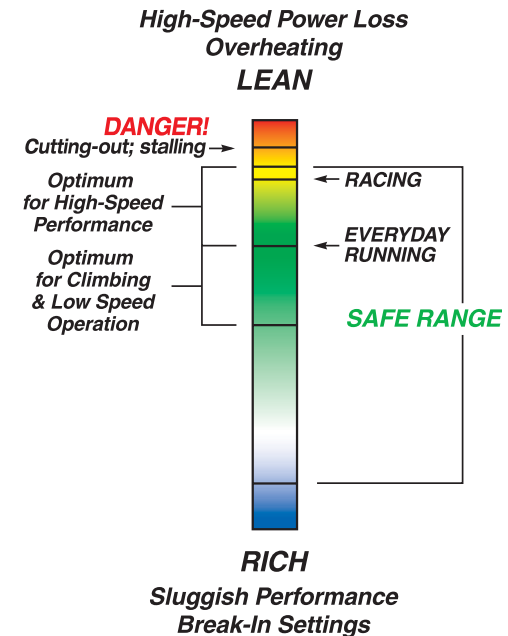

Low-Speed Fuel Mixture Adjustment

The low-speed mixture is always set after the high-speed needle is correctly adjusted. The low-speed mixture will be set using the pinch test.

1. Once the engine is warm, do several high-speed runs to confirm that the high-speed needle is set correctly.
2. Bring the vehicle in and pinch closed the fuel line going into the carburetor. The engine should run for 2-3 seconds, speed up, and then die.
3. If the engine runs longer than 3 seconds, then lean the low-speed needle 1/16 turn, make several more high-speed runs, and retest.
4. If the engine dies immediately without speeding up, then richen the low-speed needle 1/8 turn, make several more high-speed runs, and retest.

When the low-speed needle is set correctly, the engine's throttle response should be very quick, possibly even to the point of making it difficult to keep the Nitro Rustler from doing a wheelie when you accelerate!

Idle Speed Adjustment

Once the high and low-speed mixtures have been set, reduce the idle speed to the minimum reliable idle speed. Remember, this adjustment should be made while the engine is running at normal operating temperature.

1. Turn the throttle trim on the transmitter so that the brakes are applied. This ensures that the throttle slide is resting against the idle adjustment screw.

2. If necessary, remove the air filter to gain access to the idle adjustment screw.
3. Turn the screw counterclockwise to reduce the idle speed, or clockwise to increase it. The idle speed should be set as low as possible while still maintaining reliable running characteristics.
4. Reset the throttle trim on the transmitter

Fine-Tuning the Carburetor

After fine-tuning your TRX 2.5 racing engine at the end of the break-in procedure, no major adjustments to the fuel mixture are usually necessary. Make note of the temperature, humidity, and barometric pressure at the time you finished fine tuning your carburetor. Current weather conditions can be found online from national websites, local TV news websites, and Television. This information will be considered your baseline setting. You may need to adjust your carburetor needles to compensate for changes in temperature and barometric pressure (air density) from day to day. Generally, you'll need to richen the fuel mixture when the weather is colder than your baseline temperature and the air density is higher. Lean the fuel mixture when weather is warmer than your baseline temperature and the air density is lower. The chart below provides general guidelines on how weather conditions affect air density when they move higher or lower than your baseline setting (see page 28 for detailed info on how air density affects mixture settings).



Check the Traxxas website for additional information on base line settings for your area.

If the...	is..	then the air density is...	adjust (correct) the fuel mixture to be...
Humidity	Lower	Slightly more dense	Slightly richer
	Higher	Slightly less dense	Slightly leaner
Pressure (barometer)	Lower	Less dense	Leaner
	Higher	More dense	Richer
Temperature	Lower	More dense	Richer
	Higher	Less dense	Leaner
Altitude	Lower	More dense	Richer
	Higher	Less dense	Leaner
Nitro %	Lower		Leaner
	Higher		Richer

Tuning The Engine By Temperature

The following procedures require an optional infrared temperature probe or on-board temperature gauge (Traxxas on-board digital temperature gauge, part#4090).

Engine temperature can be used as an effective tuning aid when you understand the relationship between engine temperature and ambient temperature.

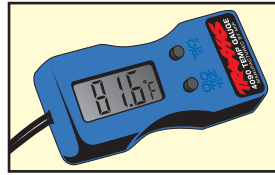

The engine operating temperature, when tuned for maximum performance, will vary according to atmospheric conditions. The atmospheric condition that has the most influence on engine temperature is air temperature. Expect the engine temperature to vary almost in direct proportion to atmospheric temperature. Assuming you tuned the engine for the same maximum performance each day, the engine will run about twenty degrees hotter when it's ninety degrees outside than it would in seventy-degree weather. For this reason, we cannot give you a definitive temperature range that indicates the best possible engine tuning.

The temperature gauge can aid you in tuning by giving you a relative indication of how your adjustments are affecting the engine and by preventing you from exceeding maximum engine temperature. For example, as you lean the fuel mixture, the engine performance will increase along with the temperature. If you continue to lean the fuel mixture and the temperature increases but the engine performance does not change, then you have exceeded the maximum safe lean setting.

Even if it's 100°F outside, you should be able to tune for maximum performance. Try to keep your engine from exceeding 270°F when measured at the glow plug. If tuning for maximum performance results in engine temperature exceeding 270°F, try to increase airflow to the engine by cutting out the rear of the body, windshield, and front valance. If the engine temperature still cannot be kept below 270°F, richen the high-speed needle slightly.

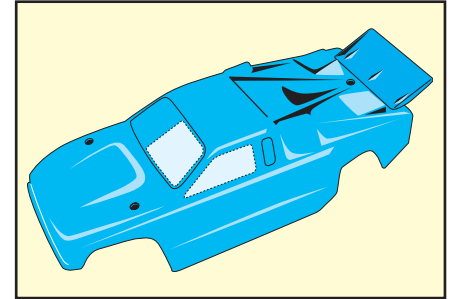

Introduction

Your TRX 2.5 racing engine is broken in, the fuel mixture is balanced, and the idle is set...now it's time to have some fun! This section contains instructions on driving and making adjustments to your Nitro Rustler. Before you go on, here are some important precautions to keep in mind.



- ▶ **Don't run your Nitro Rustler in water, mud, snow, or wet grass.** It's tempting, but water and mud are easily drawn through the air filter and will severely damage the engine. Small amounts of moisture can cause electronics to fail and loss of control over your Nitro Rustler.
 - ▶ The TRX 2.5 is extremely powerful. Remember to apply the throttle gradually to prevent wheelies or loss of control.
 - ▶ Don't hold the Nitro Rustler off the ground and rev the engine excessively with no load on the engine. This practice could result in internal engine damage. Avoid over-revving the engine when the Nitro Rustler is airborne after a jump.
 - ▶ Avoid excessive high-speed running for extended periods of time or over long distances. This could cause the engine to build up enough speed to exceed maximum safe RPM limits.
 - ▶ Don't drive your Nitro Rustler with drive train damage of any kind. The engine could be damaged due to overloads on the engine caused by drivetrain friction, or over-revving caused by loose or missing parts.
 - ▶ Don't tow anything with your Nitro Rustler. The engine is cooled by airflow created by speed. Towing creates a high load on the engine, and at the same time limits cooling of the engine due to low vehicle speed.
- ▶ If your Nitro Rustler gets stuck, stop driving immediately. Move the vehicle and then continue driving.
 - ▶ When jumping, apply some throttle while the Nitro Rustler is in the air to keep the truck's nose up and land level on all 4 wheels. Be careful not to over-rev the engine or land at full throttle. Either could seriously damage your Nitro Rustler. If the nose of the truck is too high, then quickly tap the brake to level the truck in the air.

Adjusting Your Nitro Rustler

Once you become familiar with driving your Nitro Rustler, you may wish to make adjustments for better driving performance.

Adjusting the Slipper Clutch

The Nitro Rustler features an adjustable slipper clutch on the spur gear to help protect the drive train from sudden shock loads (such as landing off of jumps with the engine at full throttle). Under normal conditions the slipper clutch should not slip. Before adjusting the slipper clutch, turn the model off. Do not adjust the slipper clutch while the engine is running.

Use the supplied glow plug (universal) wrench to tighten the slipper nut (clockwise) until it stops, and then back the nut out 1/4 of a turn. If you notice any decrease in performance after making changes to the slipper clutch adjustment, then it may be too loose. The slipper must not be allowed to slip during normal acceleration or the slipper could be damaged.

Adjusting the Toe-in

Geometry and alignment specs play an important roll in your truck's handling, so take the time to set them correctly. Set the steering trim on your transmitter to neutral. Now, adjust your tie rods so that both wheels are pointing straight ahead and are parallel to each other (0 degrees toe in). This will ensure the same amount of steering in both directions. If you run out of adjustment, then the steering servo will have to be re-centered (see "centering your servos on page 20). **For increased stability add 1-2 degrees of toe in to each front wheel. Use the turnbuckles to adjust the alignment.**

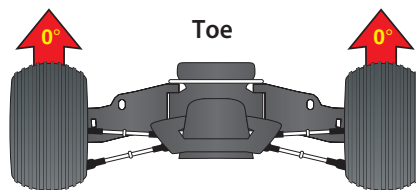

Adjusting the Camber

The camber angle of both the front and rear wheels can be adjusted with the camber rods (upper turnbuckles). Use a square or right-angle triangle to set the camber accurately. Adjust the front wheels to 0 degrees of camber (wheel perpendicular to the ground). In the rear, adjust the wheels

to 1 to 2 degrees of negative camber. These adjustments should be set with the car positioned at its normal ride height.

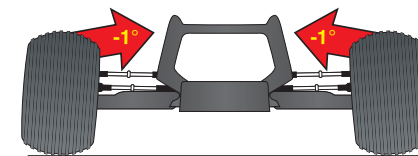

Camber

Fine Tuning the Shocks

The four shocks (oil dampers) on your Nitro Rustler have tremendous influence on its handling. Whenever you rebuild your shocks, or make any changes to the pistons, springs or oil, always do it carefully and in sets (front or rear). Piston head selection depends on the range of oil viscosities that you have available. For example, using a two-hole piston with lightweight oil will give you the same damping as a three-hole piston with heavier oil. We recommend using two-hole pistons with a range of oil viscosities from 10W to 40W (available from your hobby shop). The thinner viscosity oils (30W or less) flow with less resistance and provide less damping, while thicker oils provide more dampening. Use only 100% pure silicone shock oil to prolong seal life. From the factory, the Nitro Rustler uses 30W oil.

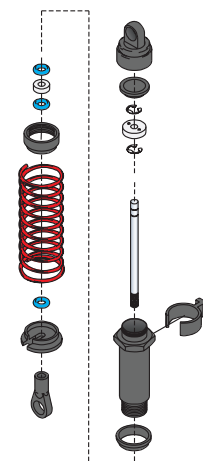

The ride height for the Nitro Rustler can be adjusted by adding or removing the clip-on spring pre-load spacers. Note that changes in ride height will occur when changes in shock angle or spring rates are made. You can compensate for ride height changes by changing the pre-load spacers on the shocks

Troubleshooting Your Nitro Rustler

The following section addresses some very basic engine and radio questions you may have about your Nitro Rustler. Most questions arise from simple user errors or minor adjustments that are easy to correct. If you can't find a solution for your Nitro Rustler here, then visit our Web site at www.Traxxas.com and click on the Customer Support menu. There you will find a much more extensive and detailed online troubleshooting area. In addition, you may call Traxxas Customer Service at 1-888-TRAXXAS (outside the US call 972-265-8000).

Radio system does not work properly:

- ▶ If the power light on the transmitter does not come on, check for proper battery installation and that the batteries are new and/or fully charged. If the power light is blinking, then the transmitter batteries are weak and should be replaced. See page 13 for more details.
- ▶ If the transmitter light is on but the radio is still not responding, check for proper installation of the receiver batteries and that the batteries are new and/or fully charged. Check to make sure the on/off switch on the model is in the on position. Finally, if there is still no response check the red and black wires that connect the battery pack to the "batt" terminal on the receiver (you will have to remove the receiver cover). Make sure the wires are not pinched or damaged and that the plug is secure in the receiver. See page 14 for more details.

Short radio range:

- ▶ If the radio range appears short, then first check to make sure the transmitter antenna is fully extended and that the antenna in the Nitro Rustler is in place and has not been cut or damaged. Next, make sure the batteries are all fully charged. Finally, if you are still experiencing short range, try a different location. Sometimes there can be interference from various sources that can cause your radio to malfunction.

Engine will not spin (EZ-Start will not turn the engine):

- ▶ If neither LED on the controller lights, the EZ-Start battery could be discharged or improperly connected. Inspect and recharge if necessary.

- ▶ If the glow plug LED lights and the motor LED does not, then the EZ-Start controller is in protection mode. Allow the controller to cool for at least three minutes. The circuitry should automatically reset.
- ▶ Check to make sure the wires are connected to the EZ-Start motor in the Nitro Rustler. The red wire should connect to the positive motor terminal, indicated by a red dot next to the terminal.
- ▶ The engine could be flooded. If too much fuel accumulates in the combustion chamber at start up, the engine will hydraulically lock. Follow the procedure on page 40 for clearing a flooded engine.
- ▶ Check for binding at the engine flywheel. If you are not able to turn the engine by hand, the engine could be flooded, there could be binding in the clutch system, or there could be internal engine damage. (Note: It is normal for the engine to be extremely tight and hard to turn when the piston reaches the top of the compression stroke.)

Engine extremely sluggish, hard to start, and will not idle during tank 1 of the break in:

- ▶ It is possible that the factory adjusted break-in settings on your carburetor are too rich for your geographic location, atmospheric conditions, or fuel brand. Extremes in temperature, humidity, barometric pressure, and altitude can't always be accounted for with a single high-speed needle setting. The symptoms described above can occur when the air density is very low such as in high mountainous elevations, and extremely cold temperatures. Under these conditions, lean the fuel mixture slightly, 1/8 turn, to see if there is any improvement in starting and idling. Only lean the fuel mixture just until the engine will run and idle reliably and then proceed with the break in.
- ▶ The contents of different brands of fuel (other than Traxxas Top Fuel) in combination with extreme atmospheric conditions can also make the factory preset break-in settings too rich and cause the symptoms described above. Again, try leaning the fuel mixture slightly, 1/8 turn, to see if there is any improvement in starting and idling.

Engine spins but will not start:

- ▶ If the engine is spinning but will not start, first check to make sure that both the motor and glow plug LEDs on the EZ-Start controller light when the button is depressed. If the glow plug LED does not light, make sure the blue glow plug wire is tightly connected and is not damaged in any way. If the wire is good, then replace the glow plug. It is normal for glow plugs to require periodic replacement. Only use Traxxas heavy-duty long glow plugs (part #3231).
- ▶ Check to make sure the fuel is getting to the carburetor. Remove the fuel line where it connects to the carburetor to see if there is fuel in it. If not, you may need to prime the engine. Reconnect the fuel line and then refer to page 32 for instructions on priming the engine.
- ▶ Check your fuel mixture settings. It may be necessary to adjust the fuel mixture if the outside temperature or barometric pressure has changed significantly since the last time the engine was run (see *Fine Tuning the Carburetor* on page 36). Turn the high-speed needle out (rich/counterclockwise) 1/4 turn, hold the throttle trigger at about 1/2 throttle and try again to start the engine. Once started, retune the engine for performance (see page 35).
- ▶ The engine could be worn. If the fit between the piston and sleeve is loose, compression is reduced and the engine will be difficult to start when it is warm, and may tend to stall when running and when the throttle is closed suddenly to idle. Engine life depends on many factors including fuel type, air filter maintenance, needle settings, and how the engine was used. For example, if the engine was allowed to ingest dirt from lack of air filter maintenance or running through water, then the internal engine components could wear out extremely fast.

Engine performance sluggish:

- ▶ Engine performance depends mostly on the fuel mixture settings and how they compensate for the current atmospheric conditions. Before you suspect other failures with the engine, richen the high-speed needle at least 1/4 turn and then retune the engine for performance (see page 35).

- ▶ If the fuel mixture seems to be set correctly, make sure the fuel is fresh. If the fuel is old, or was left uncapped for a long period, then some of the important fuel components could have evaporated. Try new, fresh, Traxxas Top Fuel
- ▶ Try a new Traxxas 3231 glow plug. Sometimes a glow plug will work well enough to start the engine but not be able to deliver the engine's full performance potential.
- ▶ Check to make sure there is no binding in the driveline that would cause excessive loads on the engine.

Clearing a Flooded Engine:

If the engine is primed for too long during startup, then it can become flooded with fuel. When the engine is flooded it will no longer turn due to excess fuel in the combustion chamber preventing upward movement of the piston. Use the following procedure to clear a flooded engine.

1. Remove the blue glow plug wire.
2. Remove the glow plug and gasket with the glow plug wrench supplied with your model. A 5/16 nut driver will also work.
3. Turn the model upside down and plug in the EZ-Start controller.
4. Push the EZ-Start button for several seconds to clear the engine of excess fuel
5. Turn the model over and reinstall the glow plug and gasket.
6. Reconnect the blue glow plug wire to the glow plug.
7. Reconnect the EZ-Start controller
8. Do not prime the engine. Pull the throttle to 1/2 throttle and push the EZ-Start button. The engine should start immediately.

Maintaining and Storing Your Nitro Rustler

Your Nitro Rustler requires timely maintenance in order to stay in top running condition. **Neglecting the maintenance could allow dirt, deposits, and moisture to build up inside the engine leading to internal engine failure.** The following procedures should be taken very seriously.

After each hour of running:

- ▶ Clean and re-oil the air filter. The instructions for this procedure are on page 27. **We cannot stress enough the value of cleaning your air filter at the scheduled intervals. Do not neglect your air filter maintenance!**
- ▶ Clean the outside of the engine of accumulated dirt, oil, and grime. Accumulated grime will decrease the engine's ability to cool itself.

After each running session:

- ▶ Perform after-run maintenance on the engine. This clears the engine of destructive moisture and other corrosive deposits. **This is extremely important for the life of the engine. See page 42 for after-run maintenance procedures.**
- ▶ Inspect the vehicle for obvious damage or wear. Look for:
 1. Loose or missing screws
 2. Cracked, bent, or damaged parts
 3. Cut or loose wiring
 4. Cut or kinked fuel lines
 5. Signs of fuel leakage
- ▶ Inspect the gears for wear, broken teeth, or debris lodged between the teeth.

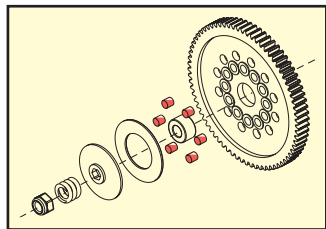



Other periodic maintenance:

- ▶ **Slipper clutch pegs** (friction material): The slipper clutch pegs will wear over time and require replacement. The life of the pegs depends on how the slipper clutch was adjusted and how the Nitro Rustler was used. If the slipper will not tighten or you are seeing signs of wear on the face of the gear,

then the pegs should be replaced.

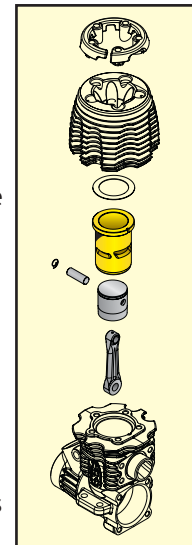
- ▶ **Piston/sleeve:** The life of the piston and sleeve will vary greatly with how the engine was used and maintained. The piston and sleeve should be replaced when they no longer seal effectively (loss of compression). Symptoms include the engine being difficult to start when warm, stalling when warm, and stalling when throttle is suddenly closed to idle. Replace the wrist pin and G-clip whenever the piston and sleeve are replaced.
- ▶ **Connecting rod:** The connecting rod should be replaced when the piston and sleeve are replaced or after three gallons of fuel, whichever comes first. Also replace the piston wrist pin and G-clip whenever the connecting rod is replaced. As with other internal engine components, connecting rod life depends engine's usage and the quality and frequency of the engine maintenance.
- ▶ **EZ-Start:** The cush drive elements in the EZ-Start drive unit should be inspected after 3-gallons of fuel. If the cush drive elements appear deformed or hardened they should be replaced. Inspect the EZ-Start gears for any signs of wear. Damaged gears should be replaced. Coat the gears with a thin layer of white lithium grease.



 If the engine is worn or damaged enough to require replacing the piston, sleeve, or connecting rod, consider exchanging your old engine for a brand new engine under the terms of the Traxxas Lifetime Engine Replacement Plan (ERP). It could save you time and effort. Details are in your model's documentation package or on our website.

 The TRX 2.5 is designed to be easy to rebuild. Critical engine components such as the crankcase, crankshaft, and engine bearings are made to extremely high quality standards and should under normal circumstances outlast multiple sets of pistons, sleeves, connecting rods, and wrist pins (reciprocating assemblies). It could be more economical for you to continue to use your good bearings and crankshafts, and simply replace the reciprocating assembly as needed. Engine assembly is not difficult and replacing the reciprocating assembly does not require any special tools or skills.



Denatured alcohol (available from home centers and paint supply stores) in a spray bottle is an extremely effective cleaner. Be sure to wear safety glasses and gloves when working with denatured alcohol.



Fun fact: WD-40™ stands for “water displacement attempt #40.” The WD-40™ product used today was the successful 40th attempt at creating a water-displacing lubricant. WD-40™ was the lab test label.



Be sure to follow proper maintenance and storage procedures to avoid damage to your engine and other components of your Nitro Rustler.



Don't put the fuel from your tank back into your fuel jug. Dispose of it properly, following city or county regulations.



Always wear eye protection when using compressed air or spray cleaners and lubricants.

After-run Procedure

You must perform after-run maintenance on your Traxxas engine whenever the model will be stored for longer than a few hours. Taking the time to prepare your engine for storage will reward you with longer engine life, easier starting, and better performance.

When a nitro engine is shut off, some excess unburned fuel remains in the engine. The methanol in model engine fuel is hygroscopic, which means it easily attracts and absorbs moisture. This moisture can cause rust and corrosion on the steel engine parts (crankshaft, bearings, wrist pin and starter shaft) if the fuel is not removed from the engine. There are after run oil products available from your hobby dealer or you can use WD-40™, a common household lubricant. To ensure your TRX 2.5 racing engine is protected from internal corrosion, use the following procedure:

1. Whenever possible, shut off the engine by pinching the fuel line closed. This allows most of the excess fuel to be consumed by the engine. Be sure the throttle is in the idle position. You may have to pinch the fuel line closed for several seconds before the engine stops.
2. Completely empty the fuel tank. Use your fuel-dispensing bottle to suck out the old fuel. Do not mix the old fuel with your fresh fuel supply. If you leave fuel in the tank, transporting or handling your Nitro Rustler may cause fuel to run into the engine.
3. With the fuel tank empty and the throttle at the idle position, try to start the engine. The engine will most likely start and run for a few seconds as it uses up any fuel remaining in the engine and fuel lines.
4. Once the engine stops, clean the outside of the engine with compressed air or spray motor cleaner. Once the engine is clean and dry, remove the glow plug power wire, glow plug, and air filter.
5. Open the throttle fully and spray a one-second burst of WD-40 into the carburetor and into the glow plug hole (Caution! Wear safety glasses to prevent spray from getting into your eyes).
6. Place a rag or paper towel over the engine to catch any WD-40 that may come out the carburetor or glow plug hole.
7. Connect the EZ-Start controller to the model and spin the engine for 10 seconds.
8. Remove the rag or paper towel and repeat steps 5–7 two more times.
9. Clean and re-oil the air filter so it will be ready for use next time. See page 27 for air filter maintenance instructions.
10. Replace the glow plug, reconnect the glow plug power wire, and reinstall the air filter.

- ABC 23
- After-run maintenance 21, 41, 42
- After-run procedure 42
- Air density 28, 35
- Air Filter 7, 22, 23, 27, 35, 41, 42
 - Cleaning* 21, 27
 - foam* 23
 - maintenance* 40
 - oil* 6
- Air Intake 22
- Air temperature 36, 39-40
- Air/fuel mixture 28
- Air/fuel ratio 28, 29, 32
- Airflow 36
- Ambient temperature 36
- Antenna (receiver) 11, 15, 39
 - tip* 15
 - tube* 15
 - wire* 15
- Antenna (transmitter) 11, 15, 39
- Antenna Mount 7
- Atmospheric conditions 28, 36, 40
- Axle pins 9
- Barometric pressure 35, 39-40
- Baseline setting 35
- Batteries 6, 12, 13, 14, 39-40
 - charging* 30
 - receiver* 13, 14
 - rechargeable* 13, 14
 - transmitter* 13
- Batteries, Ni-MH (nickel-metal hydride) 13
- Batteries, NiCad (nickel-cadmium) 6, 12, 13, 30
- Battery box 7
- Battery compartment (Transmitter) 11, 13
- Battery holder 11, 14
- Bearings 42
- Big Block .15 23
- Binding 40
- Body mount 7
- Brake 19
- Bulkhead 7
- CA glue 9
- Camber 38
- Carb, see also Carburetor 23
- Carburetor 22, 23, 28, 39-40
 - adjustments* 28
 - barrel* 23
 - fine-tuning* 35
 - slide* 25
 - venturi* 28
- Channel 11, 12, 17, 18
- Channel number 12
- Charger 6, 30
 - peak-detecting* 30
 - timed* 30
- Chassis 7
- Clean-out 23
- Cleaning 41
- Clearing your frequency 12
- Clutch bell 22
- Combustion 28
- Combustion chamber 23
- Compression 24, 40, 41
- Connecting rod 23, 41
- Cooling fins 23
- Crankcase 22, 23
- Crankshaft 22, 23, 42
- Crystal 12, 18
- Customer service 4, 39-40
- Cylinder sealing 32
- Decals 10
- Drivetrain friction 37
- Dyno 23
- E-mail 4
- Engine, TRX 2.5 7, 22, 26
 - "cutting out"* 34
 - break-in* 21, 23, 32
 - driving procedure* 33
 - cooling* 36, 41
 - damage* 27
 - detonation* 34
 - failure* 27, 41
 - flooding* 31, 39-40
 - hesitation* 34
 - life* 40, 41
 - maintenance* 41
 - overheating* 34
 - performance* 29
 - priming* 25, 32, 39-40
 - revving* 37
 - shut off* 42
 - sluggish acceleration* 34
 - stalling* 25, 32, 34, 40, 41
 - temperature* 34, 36
 - terms* 23
 - tuning* 28, 34
 - by temperature* 36
- Exhaust 5, 22
- Exhaust fumes 32
- EZ-Start 6, 23, 24, 30, 39
 - "glow plug" LED* 30, 31, 39
 - "motor" LED* 30, 31, 39
 - battery* 30, 39
 - controller* 22, 31, 39, 40, 42
 - cush drive* 30
 - drive unit* 22
 - motor* 7, 22, 31, 39
 - plug* 7, 22
 - Protection Mode* 31, 39-40
 - Smart Start™* 30, 31

- Fit 23
- Flag color 12
- Flame-out 24
- Flooding, *see Engine; flooding*
- Flywheel 22, 39-40
- Frequency band 12, 15
- Fuel 5, 6, 24, 26, 40, 42
 - break-in fuel* 32
 - fuel dispensing bottle* 6, 26
 - Traxxas Top Fueler* 26
 - Traxxas Top Fuel* 24, 26, 40
 - unburned* 42
- Fuel flow 28
- Fuel intake 22
- Fuel line (fuel tubing) 7, 22, 24, 39
- Fuel mixture adjustment 35
 - high-speed fuel mixture* 34
 - low-speed mixture* 35
- Fuel mixture, *see also air/fuel mixture* 24, 34, 35, 39-40
- Fuel tank 7, 22, 26, 42
 - emptying* 42
 - filling* 26
 - fuel level* 32
 - tank lid* 7, 26
 - tank seal* 26
- Glow plug 24, 30, 31, 32, 34, 39-40
 - driver* 24
 - fouled* 32
 - igniter* 30
 - power wire* 22, 40, 42
- Ground wire 22
- Half shaft 7
- Head (cylinder head) 22, 23
- Head Protector 22
- Header 7, 24
- Hex hubs 9
- Humidity 35
- Idle adjustment screw 35
- Idle speed 17, 24, 29, 32, 33, 34, 35
- Idle Speed Adjustment 29, 33, 35
- Idle Speed Screw 22, 24, 29
- Jumping 37
- Lean 24, 29
 - leaning the mixture* 24
 - maximum safe lean setting* 34-35, 36
- Lubrication 29
- Maintenance 41
- Maintenance schedule 21
- Methanol 42
- Mixture needles 34
 - high-speed needle* 22, 24, 28, 35, 39-40
 - low-speed needle* 22, 24, 28, 35
- Moisture 41, 42
- Needle seat 28
- Needle settings 40
- Needle valve 24
- Negative wire 22
- Neutral (center) point 16-17
- Neutral position 12
- Nitro 24
 - content* 24, 26
 - percentage* 26
 - compensating for* 35
- Nitromethane, *see also Nitro* 24
- O-ring 24
- Oil 6
 - after-run* 6, 42
 - filter* 6
 - WD-40™* 6, 42
- On/Off switch 7, 11, 14, 18, 39-40
- Over revving 37
- Peak detection, *see Charger*
- Pinch test 35
- Pipe (tuned) 7, 22, 24, 25
- Pipe hanger 7
- Piston 24, 32
 - wrist pin* 41, 42
- Piston and Sleeve 40, 41
- Port 24
- Positive Wire 22
- Power Switch 11
- Pressure Line 7, 22
- Priming, *see Engine; priming*
- ProGraphix 10
- Punch 25
- Quick Start 8, 9, 10, 13, 14, 15, 18, 19, 20, 26, 30, 31, 32, 34, 37, 41
- Radio interference 5, 20
- Radio System 11, 12, 19, 39-40
 - adjustments* 16
 - controls* 16
 - range-testing* 20
 - rules* 18
 - terminology* 12
 - terms* 12
- Range 14, 15, 18, 20, 39-40
 - short* 39-40
- Receiver 11, 12, 39
 - cover (box)* 7, 39-40
- Receiver Crystal 7
- Required equipment 6
- Rich 25, 29
- Ride height 38
- RPM 25
 - limits* 37
- Safety 5
- Servo reversing switches 11, 16
- Servos 7, 11, 12
 - reversing* 11, 17
 - steering* 7, 11, 17, 19
 - throttle/brake* 7, 11, 16-17, 19
- Shipping 4
- Shock Tower 7

- Shocks 7, 38
 - Fine Tuning* 38
- Skid Plate 7
- Sleeve 25, 32
- Slipper Clutch 7, 38, 41
 - adjusting* 38
 - pegs* 41
- Smoke 34
- Spur Gear 7
- Stalling, *see Engine; stalling*
- Starter shaft 42
- Starting, *see Engine; starting*
- Steering mechanism 19
- Steering Trim, Electronic 11, 12, 17, 19
- Steering Wheel 11, 19
- Storage 42
- Supplies 6
- Support 4, 39-40
- Suspension Arms 7
- Tank 1 33
- Tank 2 33
- Tank 3 33
- Tank 4 33
- Tank 5 33
- Tank 6 33
- Temperature, *see Engine; temperature*
- Temperature gauge 36
 - digital temperature gauge* 36
 - infrared temperature probe* 36
- Throttle Arm 22
- Throttle Neutral Adjustment 11, 16
- Throttle response 35
- Throttle slide 35
- Throttle Trigger 11, 16, 19
- Throttle Trim, Electronic 11, 12, 16, 19, 35
- Tie Bar 7
- Tie Rod 7
- Toe-in 38
- Tools 6
- Transmission 7
- Transmitter 12, 18, 39
 - indicator light* 19
 - power indicator* 11, 13
- Traxxas Lifetime Engine Replacement Plan 41
- Trim, *see also Throttle Trim and Steering*
- Trim 12
- Troubleshooting 39-40
- Turnbuckle 7
- TQ, *see Radio System*
- Water 40
- Wear-in 25
- Weather conditions 35
- Wheelies 34
- Wheels 9
- Wiring diagram 11
- WOT 25, 28
- X-tal *see also Crystal* 12

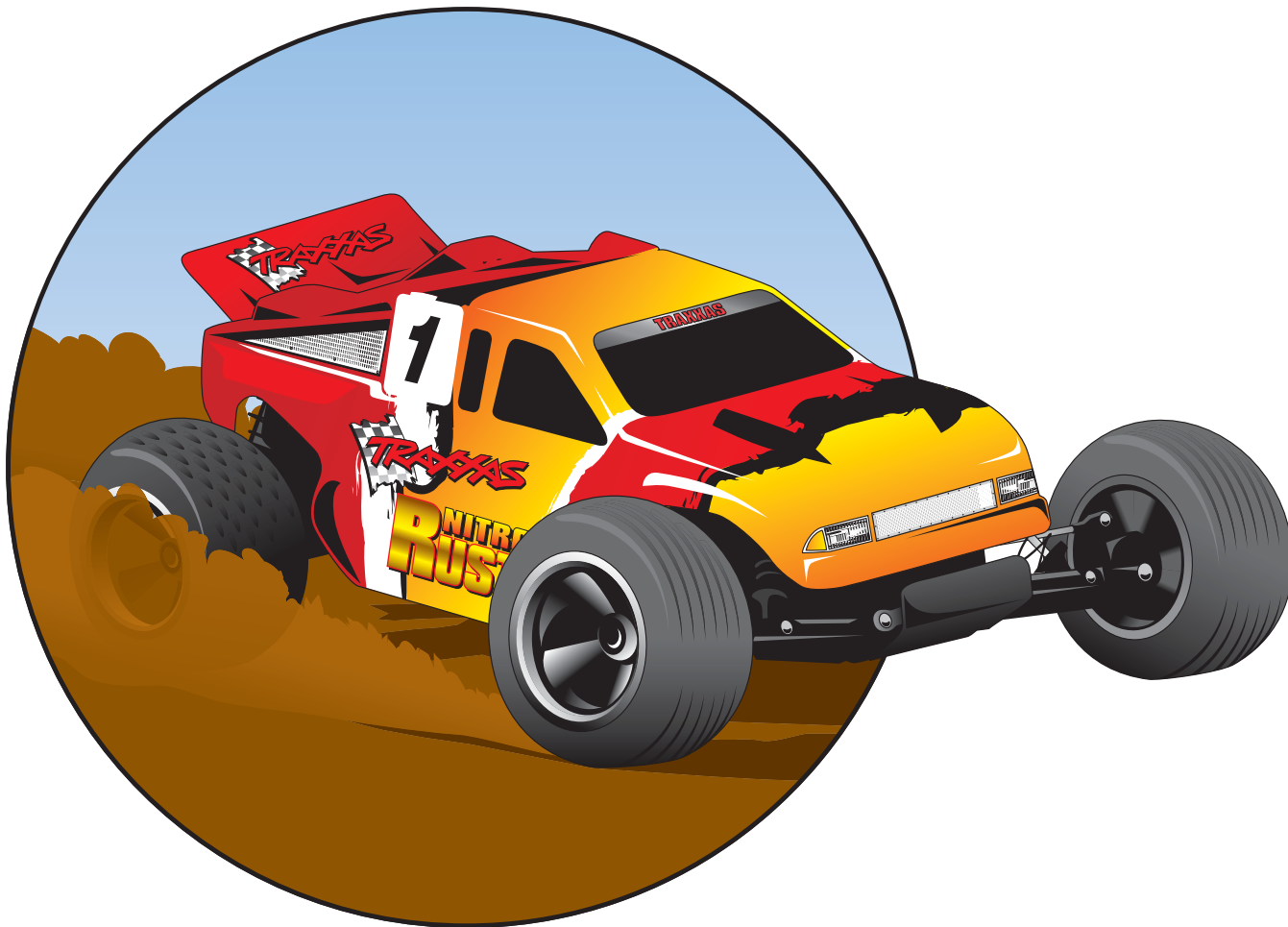

If you have any questions about your Nitro Rustler or its operation, call the Traxxas Technical Support line toll-free at:
1-888-TRAXXAS (1-888-872-9927)

NITRO RUSTLER

Traxxas Corporation, 1100 Klein Road, Plano, Texas 75074, Phone: 972.265.8000, Toll-free 1-888-TRAXXAS
Traxxas U.K., P.O. Box 1128, Winterbourne, Bristol BS17-2SH, England, Phone: 44.117.956.1002
Internet: www.Traxxas.com, www.T-Maxx.com