

MODEL 5310



# REVO

OWNER'S MANUAL

**TRAXXAS**

# INTRODUCTION

- 3 BEFORE YOU PROCEED
- 4 SAFETY PRECAUTIONS
- 5 TOOLS, SUPPLIES AND REQUIRED EQUIPMENT
- 6 ANATOMY OF YOUR REVO
- 7 QUICK START: GETTING UP TO SPEED
- 8 GLUING THE TIRES AND DECORATING YOUR REVO
- 9 THE TRAXXAS TQ-3 RADIO SYSTEM
- 18 THE TRX 2.5R RACING ENGINE
- 33 DRIVING YOUR REVO
- 34 BASIC TUNING ADJUSTMENTS
- 40 MAINTAINING AND STORING YOUR REVO
- 42 ADVANCED TUNING ADJUSTMENTS
- 46 INDEX

Thank you for purchasing the Traxxas Revo. We believe you have chosen the finest, most technologically advanced R/C monster truck available. Revo proudly represents Traxxas' passionate commitment to innovation, ultimate performance, and unmatched engineering. Revo demonstrates true state-of-the-art engineering in its radically advanced suspension, chassis, and transmission design. This new model takes Traxxas' "drive anywhere, over anything" mandate to a higher level of performance authority. There is simply no other R/C product like it.

Like an F-1 racing car, Revo is equipped with an extremely powerful, efficient, lightweight, engine; the TRX 2.5R Racing Engine. The power and reliability of the TRX 2.5R Racing Engine has been proven in thousands of Traxxas models. The rear exhaust design, trick porting, and sophisticated carburetor all come together for dramatic, high-revving power output. Add to that the smooth convenience of the on-board EZ-Start electric starting system and the TRX 2.5R Racing Engine remains in a class all by itself. Revo has been carefully engineered to keep its weight low and maintain an incredible power-to-weight ratio and seemingly perfect performance balance. You can expect quick acceleration to speeds in excess of 40mph (64.37 kph).

With all of this high-end technology jammed between the wheels of your new Revo, it's very important that you take some time to read through these instructions. This manual contains all the necessary set-up, break-in, tuning, and operating procedures that allow you to unlock the incredible performance and adjustment potential built into Revo. **Even if you are an experienced R/C enthusiast, it's important to read and follow the procedures in this manual. Revo contains new technologies in the engine, suspension, and transmission operation that you may not be familiar with. Pay particular attention to the fuel and break-in requirements for the engine. The advanced design of the TRX 2.5R Racing Engine does not follow old-fashioned thinking regarding fuel and break-in procedures.**

## Traxxas Support

Traxxas support is with you every step of the way. Refer to the next page to find out how to contact us and what your support options are.



## Quick Start

This manual is designed with a Quick Start path  that covers only the necessary procedures to get your model up and running in the shortest time possible. If you are an experienced R/C enthusiast you will find it helpful and fast. Be sure and read through the rest of the manual to learn about important safety, maintenance, and adjustment procedures. Turn to page 7 to begin.

## BEFORE YOU PROCEED

Carefully read and follow all instructions in this and any accompanying materials to prevent serious damage to your Revo. Failure to follow these instructions will be considered abuse and/or neglect.

Before running your Revo, look over this entire manual and examine the truck carefully. If for some reason you decide Revo is not what you wanted, then do not continue any further. Your hobby dealer absolutely cannot accept a Revo for return or exchange after it has been run.

### WARNINGS, HELPFUL HINTS, & CROSS-REFERENCES

Throughout this manual, you'll notice warnings and helpful hints identified by the icons below. Be sure to read them!



An important warning about personal safety or avoiding damage to your Revo and related components.



Special advice from Traxxas to make things easier and more fun.



Refers you to a page with a related topic.

### SUPPORT

If you have any questions about your Revo or its operation, call the Traxxas Technical Support line toll-free at: **1-888-TRAXXAS (1-888-872-9927)\***

Technical support is available Monday through Friday from 8:30 am to 9:00 pm central time. Technical assistance is also available at [www.Traxxas.com](http://www.Traxxas.com). You may also e-mail customer support with your question at [support@Traxxas.com](mailto:support@Traxxas.com). Join hundreds of Traxxas R/C enthusiasts in our online community at [Traxxas.com](http://Traxxas.com).

Traxxas offers a full-service, on-site repair facility to handle any of your Traxxas service needs. Maintenance and replacement parts may be purchased directly from Traxxas by phone or online at [www.BuyTraxxas.com](http://www.BuyTraxxas.com). You can save time, along with shipping and handling costs, by purchasing replacement parts from your local dealer.

Traxxas  
1100 Klein Road  
Plano, Texas 75074  
Phone: 972-265-8000  
Toll-free 1-888-TRAXXAS

Traxxas U.K.  
P.O. Box 1128  
Winterbourne, Bristol  
BS17-2SH  
England  
Phone: 44-117-956-1002

Internet  
[www.Traxxas.com](http://www.Traxxas.com)  
E-mail: [support@Traxxas.com](mailto:support@Traxxas.com)

Entire contents ©2004 Traxxas. Traxxas, Revo, TRX 2.5R Racing Engine, TQ-3, Top Fuel, EZ-Start, Ready-To-Race, Ready-To-Win, and ProGraphix are trademarks or registered trademarks of Traxxas. Other brand names and marks are the property of their respective holders and are used only for purposes of identification. No part of this manual may be reproduced or distributed in print or electronic media without the express written permission of Traxxas.

\*Toll-free support is available to U.S. residents only.

## SAFETY PRECAUTIONS



All instructions and precautions outlined in this manual should be strictly followed to ensure safe operation of your Revo.



Revo is not intended for use by children under 16 years of age without the supervision of a responsible and knowledgeable adult.

All of us at Traxxas want you to safely enjoy your new Revo. Operate your Revo sensibly and with care, and it will be exciting, safe, and fun for you and those around you. Failure to operate your Revo in a safe and responsible manner may result in property damage and serious injury. The precautions outlined in this manual should be strictly followed to help ensure safe operation. You alone must see that the instructions are followed and the precautions are adhered to.











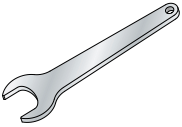

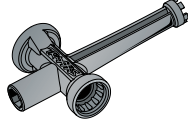
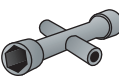
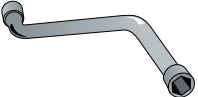
### IMPORTANT POINTS TO REMEMBER

- ⦿ The engine, exhaust system, and brakes may become extremely hot during use.
- ⦿ **Model engine fuel is dangerous and highly poisonous.** Always follow all directions and precautions printed on the fuel container.
- ⦿ Model engine fuel, especially when in a fuel dispensing bottle, may look like a cool drink to a child. **Keep all fuel out of the reach of children at all times. Do not place fuel containers on the ground where children can get to them while you are driving.**
- ⦿ Model engine fuel is flammable. Never allow smoking, sparks, heat or flame in the presence of fuel or fuel vapors.
- ⦿ The engine and exhaust system may become extremely hot during use. Be careful not to touch the parts, especially when refueling or stopping the engine.
- ⦿ Prolonged exposure to the engine exhaust can be harmful. Avoid breathing the engine exhaust. Always run your Revo outdoors, in a well-ventilated area. Never run the engine indoors.
- ⦿ Do not operate your Revo at night, or anytime your line of sight to the model may be obstructed or impaired in any way.
- ⦿ Never operate your Revo in crowds of people or busy pedestrian areas. Revo is large and fast, and could cause injury to those unaware of its presence.
- ⦿ Because Revo is controlled by radio, it is subject to radio interference from many sources beyond your control. Since radio interference can cause momentary loss of control, always allow a safety margin in all directions around your model to prevent collisions.
- ⦿ The engine can be loud. If the noise makes you uncomfortable, wear ear protection. Be considerate of your neighbors by not running your model early in the morning or late in the evening.
- ⦿ **Most importantly, use good common sense at all times.**

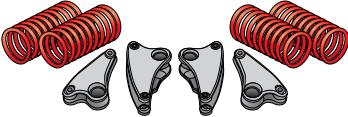







# TOOLS, SUPPLIES AND REQUIRED EQUIPMENT

Your Revo comes with a set of specialty metric tools. You'll need to purchase other items, available from your hobby dealer, to operate and maintain your model.

## SUPPLIED TOOLS AND EQUIPMENT

					
Shock wrench	8mm slipper clutch wrench	5mm turnbuckle wrench	Suspension multi-tool	4-way wrench	Glow plug and wheel nut wrench
					
1.5mm "L" wrench	2.0mm "T" wrench	2.5mm "L" wrench	2.5mm "T" wrench	Long Travel rocker and spring set	
					
RX Power Charger	RX Power plug (transformer)	RX battery power pack (installed in model)	Foam air filter oil and extra oiled air filter element (see page 23)	Suspension tuning shims and hollow balls	

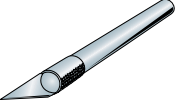
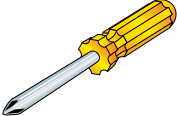
## REQUIRED TOOLS AND EQUIPMENT

				
Traxxas Top Fuel™ see page 22	8 AA alkaline batteries	NiCad or NiMh 7.2V battery pack	NiCad or NiMh battery charger	
				
Fuel dispensing bottle	After-run oil to protect the engine from corrosion	Hobby knife	Philips screwdriver	Small flat-blade screwdriver for tuning (1/8 inch blade)

➔ For more information on batteries, see *Use the Right Batteries* on page 11.

➔ A peak-detecting charger is recommended for best performance and longest battery life. Inexpensive wall chargers may also be used with very good results. For more information, see *Use the Right Charger* on page 26.

**i** **Recommended Equipment**  
These items are not required for the operation of your model, but are a good idea to include in any R/C toolbox:

- Safety glasses
- Thin, hobby-quality cyanoacrylate instant tire glue (CA glue)
- Side cutters or needle nose pliers

# ANATOMY OF YOUR REVO

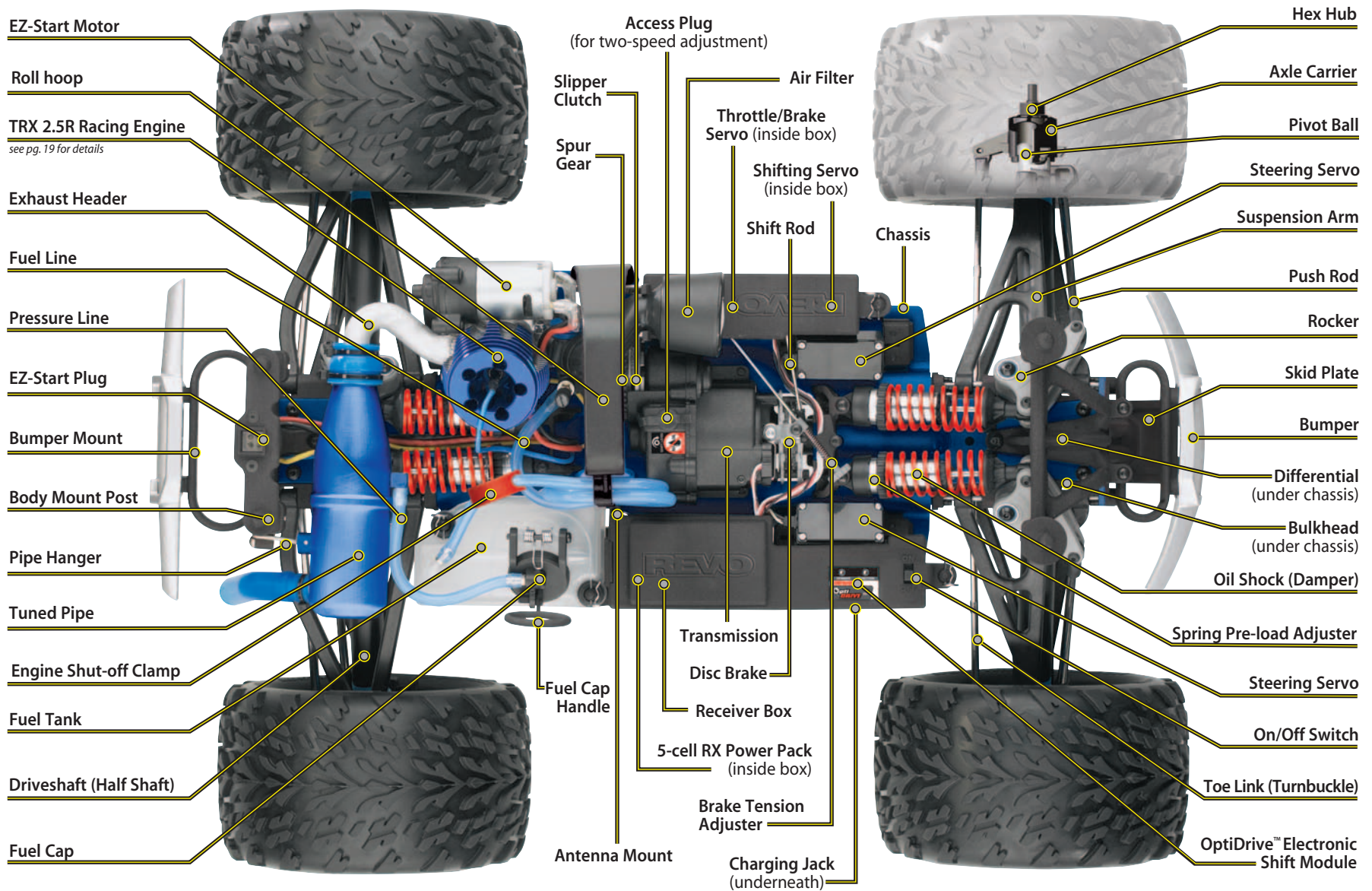

## QUICK START: GETTING UP TO SPEED

The following guide is an overview of the procedures for getting your Revo running, from opening the box to breaking in and tuning your engine. Refer to the pages indicated for details on each step. Look for the Quick Start logo on the bottom corners of Quick Start pages.

- |  |  |
|--|--|
| <input type="checkbox"/> <b>1. Read the safety precautions on page 4</b><br>For your own safety, understand where carelessness and misuse could lead to personal injury.                                   | <input type="checkbox"/> <b>10. Range test the radio system • See page 17</b><br>Follow this procedure to make sure your radio system works properly at a distance and that there is no interference from outside sources. |
| <input type="checkbox"/> <b>2. Charge the EZ-Start battery pack • See page 26</b><br>The EZ-Start requires a fully charged 7.2-volt battery pack (not included).   | <input type="checkbox"/> <b>11. Fill the fuel tank • See page 22</b><br>Use your fuel-dispensing bottle to fill the tank.  |
| <input type="checkbox"/> <b>3. Charge the RX Power Pack • See page 12</b><br>The 5-cell receiver battery is already installed in the truck. Plug the supplied charger into the charging jack on the truck. | <input type="checkbox"/> <b>12. Connect the EZ-Start to the model • See page 27</b><br>Learn the proper way to use the EZ-Start electric starting system   |
| <input type="checkbox"/> <b>4. Install the antenna • See page 13.</b><br>Install the antenna mast in Revo.   | <input type="checkbox"/> <b>13. Start the engine • See page 28</b><br>Learn to use the correct starting procedure for your TRX 2.5R.   |
| <input type="checkbox"/> <b>5. Decal and Install the body • See page 8</b><br>You will need to use the body during break in, so it's best to apply any additional decals before you use the body.          | <input type="checkbox"/> <b>14. Break-in your engine • See page 28</b><br>Follow the break-in instructions exactly to ensure the best-performing, longest-lasting engine.  |
| <input type="checkbox"/> <b>6. Install batteries in the transmitter • See page 11</b><br>Revo requires 8 AA alkaline or rechargeable batteries for the transmitter.  | <input type="checkbox"/> <b>15. Tune your engine • See page 30</b><br>Learn how to set the fuel mixture needles for optimum engine performance.  |
| <input type="checkbox"/> <b>7. Install the EZ-Start battery • See page 26</b><br>Install and connect a charged 7.2-volt battery pack in the EZ-Start controller.   | <input type="checkbox"/> <b>16. Drive your Revo • See page 33</b><br>Learn to use the two-speed and reverse function on your truck, along with important driving precautions.  |
| <input type="checkbox"/> <b>8. Turn on the radio system • See page 16</b><br>Make a habit of turning the transmitter on first, and off last.   | <input type="checkbox"/> <b>17. Maintaining your Truck • See pages 40-41</b><br>Follow these critical steps to maintain the performance of your Revo and keep it in excellent running condition.                           |
| <input type="checkbox"/> <b>9. Check servo operation • See page 17</b><br>Make sure the throttle, shifting, and steering servos are working correctly.   |  |

 The Quick Start Guide is not intended to replace the full operating instructions available in this manual. Please read this entire manual for complete instructions on the proper use and maintenance of your Revo.

Look for the Quick Start logo at the bottom of Quick Start pages.





Always wear safety glasses to prevent glue from splattering into your eyes.



The acetone in fingernail polish remover will remove excess glue from your fingers.



For best results while gluing, clean the bead of the tires and the grooves of the wheels with denatured alcohol before applying glue. This removes any mold release agent residue from the tires and wheels, providing a better bond.

## TIRE GLUING

The factory tires on your Revo are already glued to the rims. The tires must be glued to the rims to prevent the rims from spinning inside the tires. The instructions here are provided to show you how to glue replacement tires to the rims in the future. Use CA tire glue available from your local hobby dealer. You can glue the tires without removing the wheels from the truck. For clarity, these instructions show the process with the wheels removed.

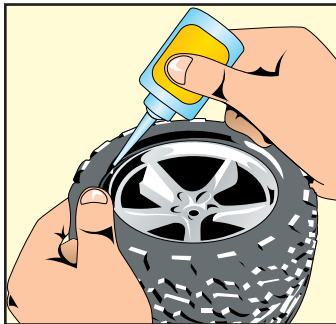
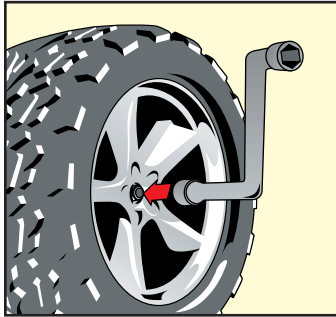

1. Remove a wheel from Revo using the larger (8mm) end of the glow plug (universal) wrench.
2. Use your thumb to push the side of the tire away from the rim. Place one or two drops of CA glue into the opening and release the tire. Capillary action will draw the glue around the bead of the tire.
3. Repeat step two at four or five points around the rim, until the tire is completely secured to the rim. Turn the rim over and repeat the process for the inside of the rim/tire. Repeat for the other 3 wheels.
4. Reinstall the wheels, make sure none of the axle pins have fallen out from behind the hex hubs.

## APPLYING THE DECALS

The main decals have already been applied to your Revo. The extra decals provided are die-cut for easy removal. Use a hobby knife to lift the corner of a decal and remove it from the backing.

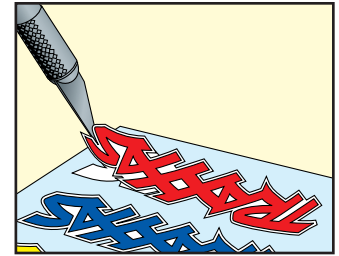

Carefully position the decal over the desired location and press one side on the body. Pull the decal tight and use a finger to gradually smooth out any air bubbles as you apply the decal.



Look at the photos on the box for typical decal placement.



# THE TRAXXAS TQ-3 RADIO SYSTEM

Your Revo is equipped with the TQ-3 radio system. The TQ-3 is a 3-channel system that provides up to a quarter mile range and control for up to three servo outputs. Revo is equipped with two high-torque steering servos connected via a "Y" plug adapter (one input, two equal outputs). The TQ-3 works in conjunction with the OptiDrive™ Electronic Shift Module to monitor the input and output signals for the throttle and shifting servos (channels). The OptiDrive monitors the voltage of the on-board RX Power Pack. The "Function" LED will flash red if the battery voltage is too low.

## TQ-3 TRANSMITTER

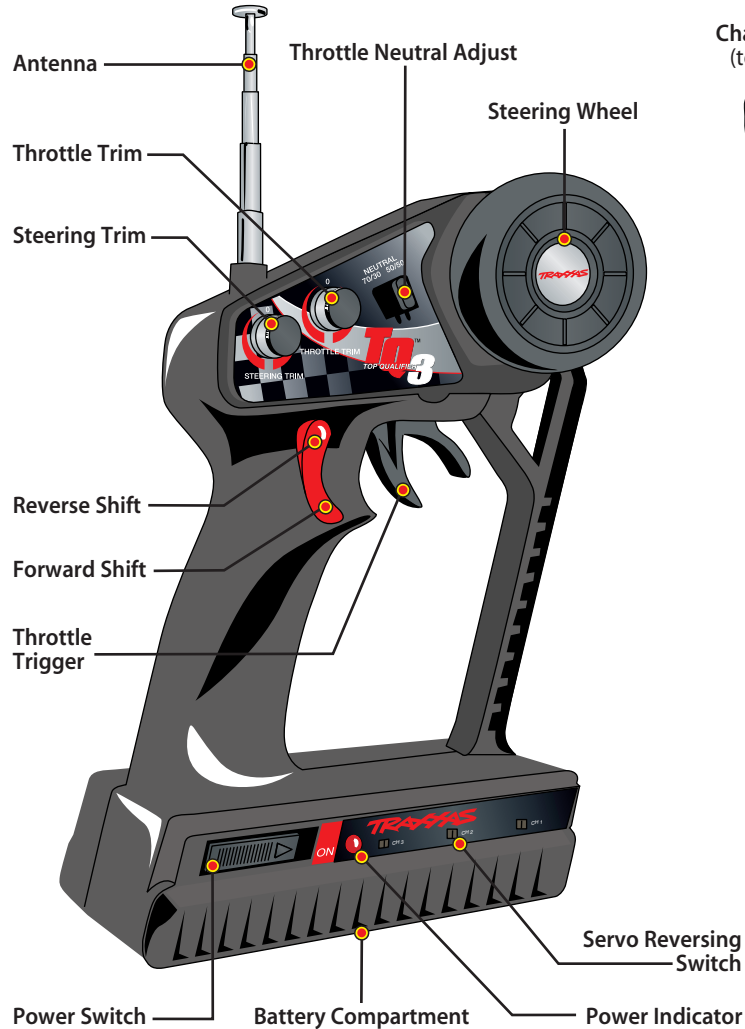

## REVO WIRING DIAGRAM

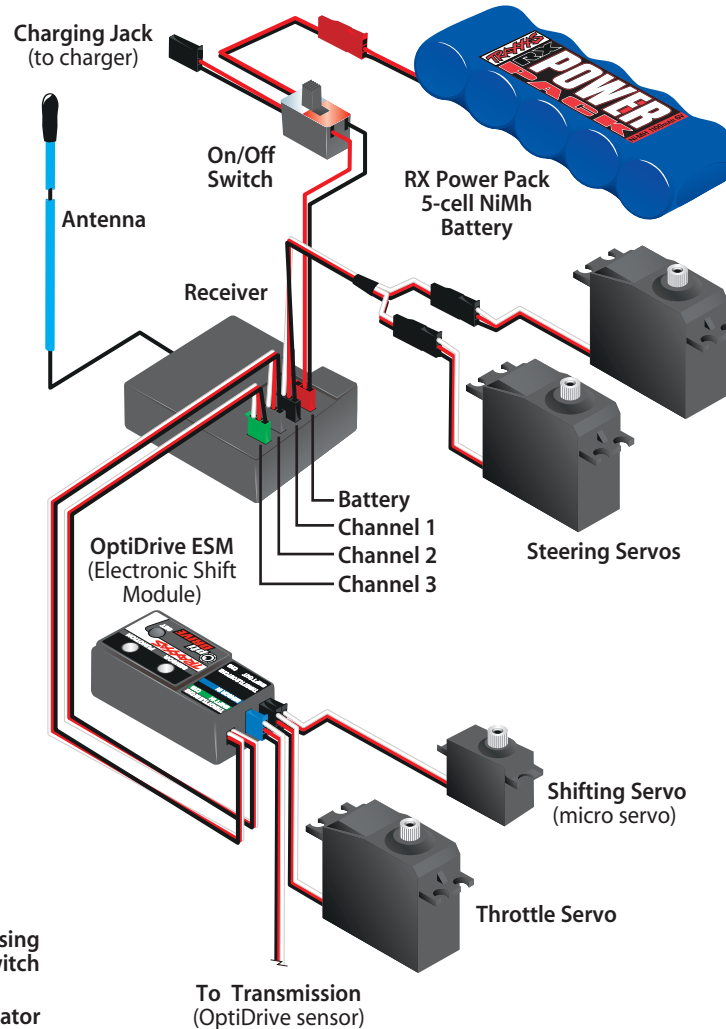

**i** The OptiDrive ESM is designed to adapt and work with aftermarket three channel radio systems (see page 15).









Learn terms related to the TRX 2.5R Racing Engine beginning on page 20.

### RADIO SYSTEM TERMINOLOGY

Please take a moment to familiarize yourself with these radio-system terms. They will be used throughout this manual.

**5-Cell Pack** – Another term for RX Pack. The RX pack is made up of five 2/3 AA rechargeable NiMH battery cells.

**Channel** - The 27 MHz frequency band is divided into 6 channels so that up to six models can be operated simultaneously. Each channel is referred to by its flag color and channel number, as shown below.

CHANNEL	FREQUENCY BAND	FLAG COLOR	TRAXXAS PART NO.
 1	26.995	BROWN	2031
 2	27.045	RED	2032
 3	27.095	ORANGE	2033
 4	27.145	YELLOW	2034
 5	27.195	GREEN	2035
 6	27.255	BLUE	2036

**Clearing your frequency** - A routine, verbal check to make sure nobody else in your area is operating on the same channel. Always clear your frequency by calling out your channel number before operating your model. Wait or move to another area if your channel is already being used.

**Crystal (X-tal)** - The plug-in device that determines which channel the radio system will operate on. For each channel, there are two crystals, one for the receiver and one for the transmitter. Of those two crystals, the one marked with the lower number (.455 MHz lower) must be inserted into the receiver.

**Frequency band** - The radio frequency used by the transmitter to send signals to your Revo. All Traxxas RTR models operate on a 27 MHz frequency band.

**mAh** – Abbreviation for milliamp hour. Measure of the capacity of the battery pack. The higher the number, the longer the battery will last between recharges.

**Neutral position** - The standing position that the servos seek when the transmitter controls are at the neutral setting.

**NiCad** - Refers to rechargeable, nickel-cadmium batteries. The most economical choice, since they may be recharged up to 500 times.

**NiMh** – Abbreviation for Nickel Metal Hydride. This is the type of rechargeable battery used to power the radio system in the model. These batteries are generally more efficient with less memory effect than NiCad batteries.

**OptiDrive ESM** – Electronic Shift Module. The onboard electronic controller that monitors vehicle speed and throttle position in order to control the action of the shifting servo. Also includes low battery indicator for the onboard receiver pack (RX Power Pack).

**Receiver** - The radio unit inside your Revo that receives signals from the transmitter and relays them to the servos.

**RX Pack** – RX is a common abbreviation for the radio receiver and items associated with it. RX-Pack denotes the rechargeable battery pack used to power the radio system in the model.

**Servos** - Small motor units in your Revo that operate the throttle, shifting, and steering mechanisms.

**Three-channel radio system** - The TQ-3 radio system, consisting of the receiver, the transmitter, and the servos. The system uses three channels: one to operate the throttle, one to shift the transmission, and one to operate the steering.

**Transmitter** - The hand-held radio unit that sends throttle and steering instructions to your Revo.

**Trim** - The fine-tuning adjustment of the neutral position of the servos, made by turning the throttle and steering trim knobs on the face of the transmitter.

**Y Adapter** – Servo cable adapter that takes one input signal and directs it to two equal output signals. Used to connect dual steering servos to the channel one receiver output.

## INSTALLING TRANSMITTER BATTERIES

Your TQ-3 transmitter uses 8 AA batteries. The battery compartment is located in the base of the transmitter.

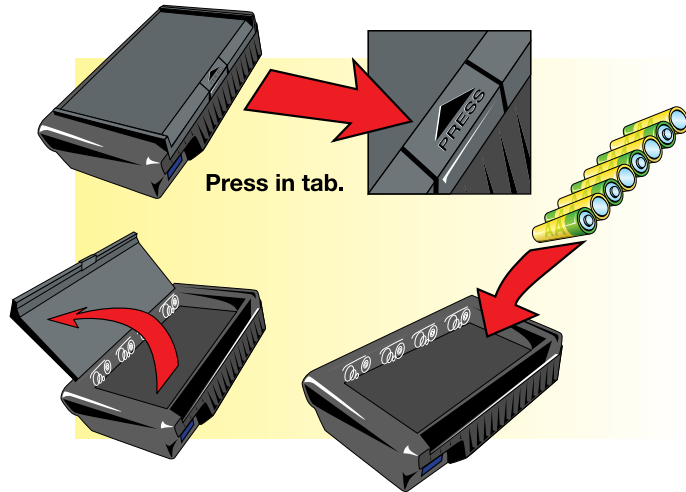

1. Remove the battery compartment door by pressing the tab and lifting the door up.
2. Install the batteries in the correct orientation as indicated in the battery compartment.
3. Reinstall the battery door and snap it closed.

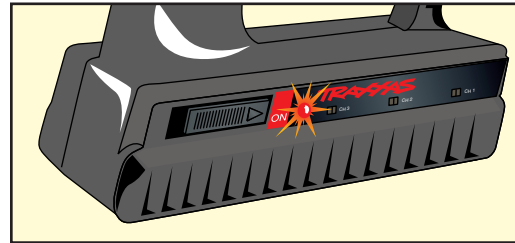

4. Turn on the transmitter and check the power indicator for a solid red light.

If the power indicator light flashes, then the transmitter batteries are weak, discharged or possibly installed incorrectly. Replace with new or freshly charged batteries. The power indicator light does not indicate the charge level of the RX Power Pack installed in the model.

**i Use the Right Batteries**  
Your transmitter uses AA batteries. Use new alkaline batteries, or rechargeable batteries such as NiCad or NiMh (Nickel Metal Hydride) batteries in your transmitter. Make sure rechargeable batteries are fully charged according to the manufacturer's instructions.

If you use rechargeable batteries in your transmitter, be aware that when they begin to lose their charge, they lose power much more quickly than regular alkaline batteries.

**Caution: Discontinue running your Revo at the first sign of weak batteries (flashing red light) to avoid losing control.**

**i** If the power indicator doesn't light red, check the polarity of the batteries. Check rechargeable batteries for a full charge.

**!** Important: When a rechargeable battery pack begins to lose its charge, it will lose power much quicker than non-rechargeable batteries. To prevent losing control of your model, you must stop driving immediately at the first sign of weak batteries. A flashing red LED on the OptiDrive ESM indicates low voltage.



Other indications of weak on-board batteries include sluggish steering response and shortened radio range.

**i** **Charger Specifications:**

- Input voltage:  
10.6/16v (min/max)
- Fast charge current:  
750/1000mA (min/max)
- Slow (trickle) charge current:  
22/55mA (min/max)
- Delta Peak:  
10mv
- Maximum charge time:  
90 minutes



**CHARGING THE RECEIVER BATTERIES**



automatically shuts off the charger when the maximum charge has been achieved. Revo has a built in charging jack so you do not have to remove the battery pack from the model. The long charger cord allows easy handling of the truck while the battery is charging.

1. The RX Power Charger can operate on either A/C or D/C power\*. An A/C power supply is supplied with Revo. Plug the end of the A/C adapter into the back of the charger.
2. Plug the A/C power supply into any 110 volt wall outlet. The charger light should glow steady green (no battery connected).
3. Plug the charger output cord into the charging jack located under the right front of the truck. The charging jack is protected by a rubber plug.
4. The green light on the charger should begin to flash quickly indicating that fast charging is in progress.
5. When the light turns solid green (not flashing) the battery pack is fully charged and ready for use.
6. Put the rubber plug back over the charging jack on the truck.

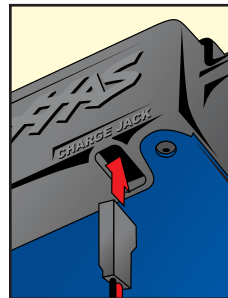

To power the radio system in the truck, your Revo is equipped with the RX Power Pack, a rechargeable 5-cell nickel metal hydride (NiMh) battery pack. The RX Power Pack must be fully charged before running the truck. The supplied RX Power Charger is a peak-detecting unit that will charge the supplied RX Power Pack in about 1 hour. The peak detection circuitry

After fast charging has completed, the RX Power Charger continues to charge in trickle (slow) charge mode. It will continue until the battery is disconnected. The RX Power Charger will automatically shut off after 90 minutes of fast charging time. When the charger is not in use, wind the charging cord around the cord holder. To secure the cord, insert the end of it into the retaining slot on either end of the cord holder. The RX Power Charger is equipped with mounting holes in the back of the case to allow convenient, out-of-the-way wall mounting.

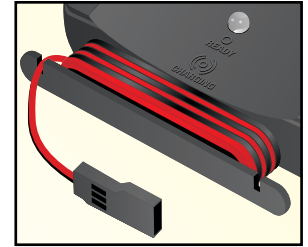

The RX Power Charger can be powered by our optional D/C car adapter. It features a tangle-free, extra long wire and integrated fuse. The long charging cord allows the model to remain outside the car while charging. **Caution! Never charge batteries in an enclosed car interior or while driving. Never leave charging batteries unattended. Monitor them closely.**



**BATTERY CARE**

Some precautions should be taken to maintain the performance of the rechargeable NiMh receiver pack in your model. Improper use of the battery pack could result in personal injury or damage to your truck.

- ⦿ Only use approved chargers for NiMh battery packs (such as the Traxxas RX Power Charger). Do not exceed the maximum charge rate of 1 amp.
- ⦿ Do not short circuit the battery pack. This may cause burns and severe damage to the battery pack
- ⦿ Do not burn or puncture the batteries. Toxic materials could be released. If eye or skin contact occurs, flush with water.
- ⦿ Store the battery pack in a dry location, away from heat sources and direct sunlight.
- ⦿ Nickel Metal Hydride batteries must be recycled or disposed of properly.
- ⦿ Do not completely discharge the RX Power Pack or you could damage it. Do not use dischargers on the pack. Store the battery with at least 25% charge. Stop running and recharge at the first indication of reduced voltage.

\* With optional D/C car adapter

## SETTING UP THE ANTENNA

1. Locate the black antenna wire that exits the receiver cover. The receiver cover is mounted on the top of the chassis, near the front. The antenna wire exits the cover just ahead of the fuel tank.
2. Pull the wire straight with your fingers and then insert the end of the wire into one end of the antenna tube. Push the wire all the way through the antenna tube.
3. Insert the base of the tube into the molded post on the side of the radio box.
4. Place the antenna tip over the top of the tube to secure the antenna wire.
5. On the transmitter, always fully extend the telescoping antenna when running your Revo. Make a habit of holding the transmitter so that the antenna points straight up.

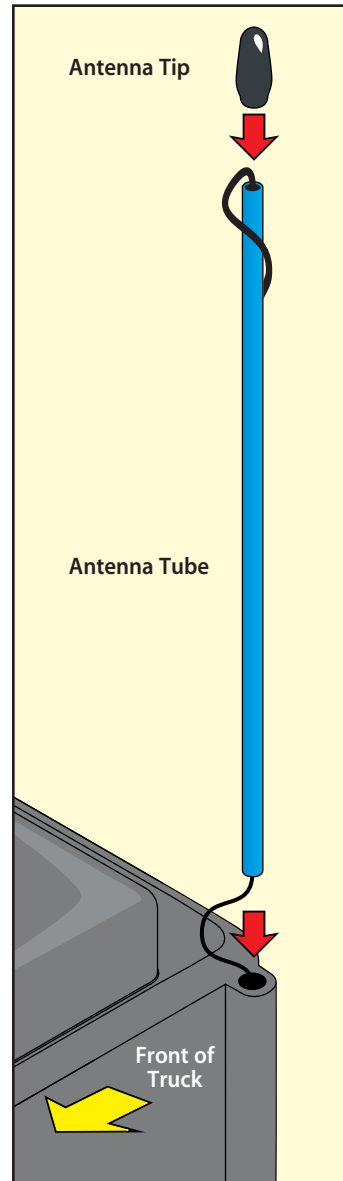

**i** Spray a little window cleaner on the antenna wire to make it easier to push through the antenna tube.

**!** Don't shorten the length of the antenna wire. Its length is tuned to the frequency band; cutting it could severely shorten the radio system's range.

**!** Don't push the transmitter antenna down from the top. Pull it down from the bottom, one segment at a time, to prevent binding and kinking the antenna mast.

## TQ-3 RADIO SYSTEM CONTROLS

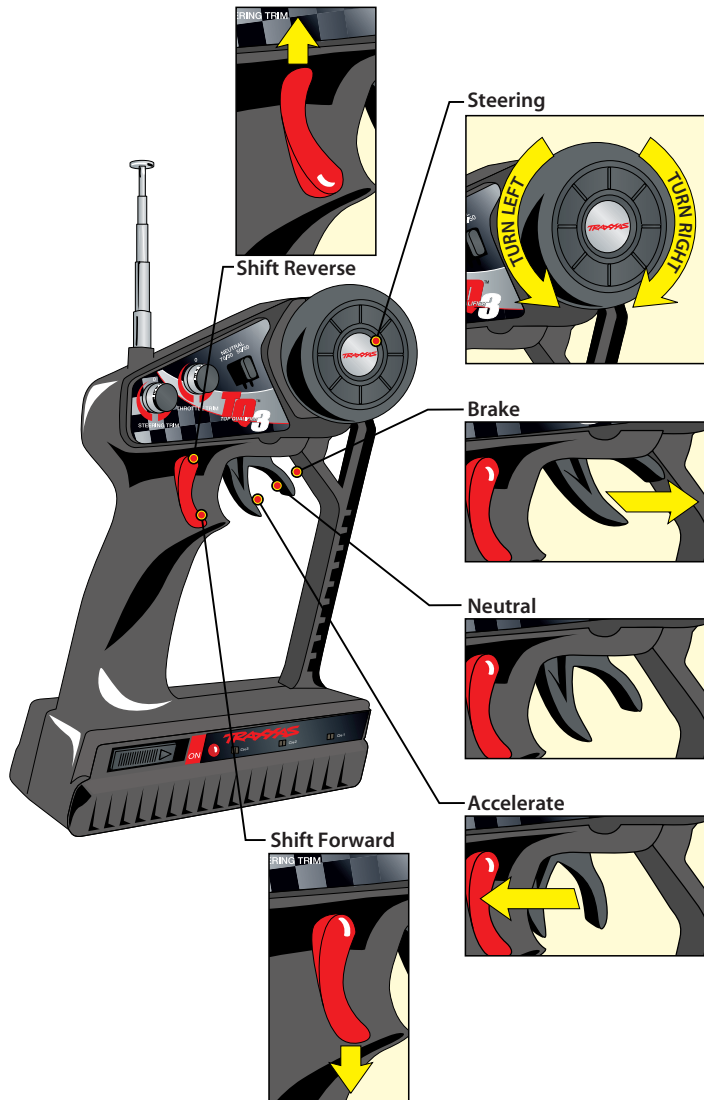

## TQ-3 RADIO SYSTEM ADJUSTMENTS

In addition to the electronic throttle and steering trim controls, your radio system features throttle neutral adjustment and servo reversing switches.

### Throttle Neutral Adjustment

The throttle neutral adjustment is located on the transmitter face and controls the forward/reverse travel of the throttle trigger. Change the adjustment by pressing the button and sliding it to the desired position. There are two settings available:

- ⦿ 50/50: Allows equal travel for both acceleration and braking.
- ⦿ 70/30: Allows more throttle travel (70%) and less brake travel (30%).

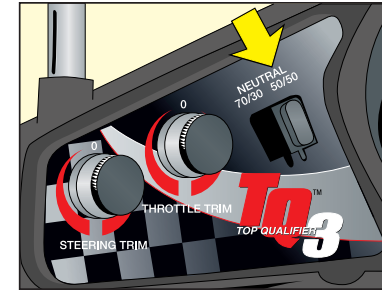

50/50 is the required setting for Revo with the TRX 2.5R Racing Engine.

### Electronic Throttle Trim

The electronic throttle trim located on the face of the transmitter adjusts the neutral (center) point of the throttle servo when the servo is at rest. This control has been preset for you at the factory. If necessary, adjust the control so that the carburetor is at idle, and the brakes are not applied (the model will roll freely). Do not use the throttle trim to raise or lower the engine idle speed. Make the idle speed adjustment on the carburetor.

### Electronic Steering Trim

The electronic steering trim located on the face of the transmitter adjusts the neutral (center) point of the steering servos when the servos are at rest. Adjust this control to make the model drive straight with no steering input at the wheel.

## Servo Reversing Switches

The servo reversing switches are located on the front of the transmitter, next to the on/off switch. Moving a switch reverses the direction of the corresponding servo. Each switch corresponds to a channel, as shown below. For example, if you turn the steering wheel to the right and your front wheels turn left, you would move the channel 1 switch to correct the servo direction. It may be necessary to adjust the corresponding trim control after moving a switch. The default position for the servo reversing switches is shown.

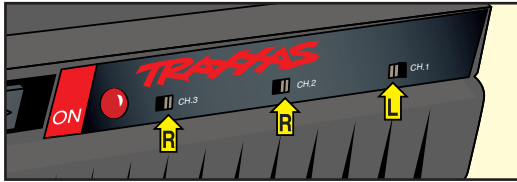

TQ-3 CHANNEL TO SERVO CHART

CHANNEL	SERVO
1	STEERING
2	THROTTLE AND BRAKING
3	SHIFTING

## Programming the OptiDrive™ ESM

The OptiDrive ESM electronically monitors vehicle speed and controls forward and reverse shifting. Controlling the shift action electronically rather than by mechanical systems reduces the number of components in the transmission. The transmission weighs less, there is lower rotational mass for quicker acceleration, and constant drive engagement for smooth power delivery.



The OptiDrive module prevents the transmission from changing directions while the truck is in motion. The truck must be completely stopped to change directions, regardless of the position of the shift selector switch on the transmitter. The OptiDrive module is preset at the factory. If the transmitter throttle trim adjustment is changed, then the OptiDrive module will need to be re-programmed.

1. The engine must be shut off. The radio system must be on (receiver and transmitter).

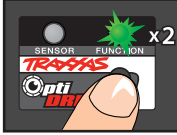
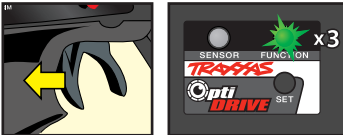
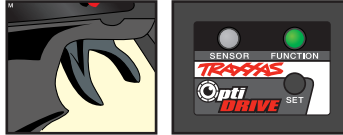
2. Set the TQ-3 Transmitter to its factory default shift settings:
  - Set the THROTTLE NEUTRAL switch to the 50/50 setting.
  - Set the THROTTLE TRIM to the center "0" setting, then adjust the THROTTLE TRIM until the carburetor closes.
  - Set the CHANNEL 2 SERVO REVERSING SWITCH to the right position.
  - Set the CHANNEL 3 SERVO REVERSING SWITCH to the right position.
  - DO NOT change the position of any of the servo reversing switches after programming the OptiDrive. If settings were changed after programming the OptiDrive, it will have to be reprogrammed.
3. With the throttle at neutral, press and hold the SET button until the Function LED flashes green twice and then release the button immediately. You are now in programming mode.
 
4. Pull the transmitter throttle trigger to the full throttle position. Hold it there until the Function LED flashes green three times. **Note:** The throttle servo will not move during programming even though it is connected to the controller.
 
5. Release the transmitter throttle trigger allowing it to return to neutral. The Function LED will turn solid green, indicating that the shifting servo is OK to shift and the programming has been completed. The controller is now programmed and ready to go!
 
  - If the transmitter throttle settings are changed, it will be necessary to complete the programming sequence again.
  - If the SET button is released before the Function LED flashes green twice in step 3, the OptiDrive will return to the normal operation mode.
  - If you experience any problems during programming, turn the receiver off, then on again, and repeat the programming steps.

For instructions on how to use the OptiDrive with aftermarket radio systems, or to access advanced programming options, visit our website, [www.Traxxas.com](http://www.Traxxas.com).

**i** Large adjustments to the throttle trim and/or throttle linkage may require re-setting the OptiDrive ESM to maintain proper shifting action.

**i** For transmission durability, the OptiDrive ESM limits the model's reverse speed to about 70% of full throttle. If settings are changed, and you notice a decrease in forward top speed, you could have the OptiDrive system reversed. Return the TQ-3 servo-reversing switches for channels two and three back to their default settings and re-program the OptiDrive Module. For programming with aftermarket radio systems, please see our website.

## OptiDrive Operation

- **Green "Function"** Shift allowed
- **Red flashing "Function"** Low battery, see pg. 12
- **Red "Sensor"** Sensor circuit is broken. Possible disconnected sensor, broken wires, or damaged sensor.
- **Blue flashing "Sensor"** Normal operation as vehicle moves. Indicates signal pulse from sensor. Depending on the rotor position, solid blue or off when vehicle is at rest.



Remember, always turn the TQ-3 transmitter *on first* and *off last* to avoid damage to your Revo. Never turn the radio off while the engine is running.

### TQ-3 RADIO SYSTEM RULES

- Each time you prepare to run your Revo, you must clear your frequency to be sure no one else in the area is using the same channel as you.

There are six possible channels, numbered 1 through 6. Each is represented by a color. Look at the crystal plugged into the back of your transmitter to determine which channel your truck is assigned to.

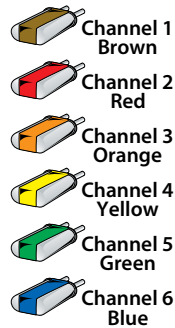

- Always turn your TQ-3 transmitter on first and off last. This procedure will help to prevent your Revo from receiving stray signals from another transmitter, or other source, and running out of control.

- Always have the transmitter and receiver turned on before you start the engine. Never turn the radio system off while the engine is running. The on/off switch in the model only turns the receiver on and off. It does not turn off the engine.
- Always use new or freshly charged batteries for the transmitter, and make sure the on-board 5-cell NiMh battery pack is fully charged. The function light on the OptiDrive will flash red if the 5-cell battery pack requires charging. Weak batteries will limit the range of the radio signal between the receiver and the transmitter. Loss of the radio signal can cause you to lose control of your Revo.

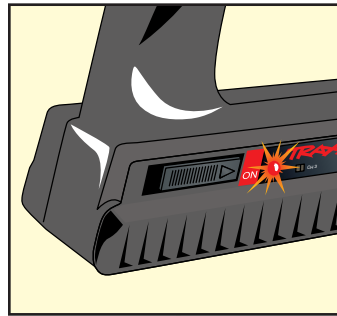

1

Always turn your transmitter on first.

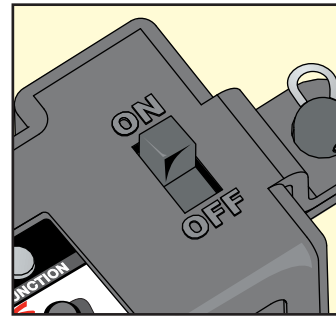

2

Always turn your receiver on second.

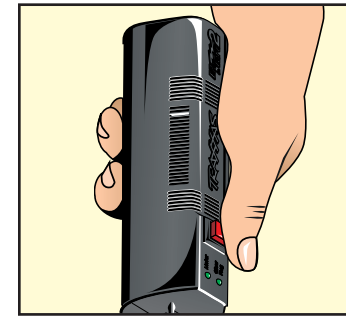

3

Then start your engine.



## USING THE TQ-3 RADIO SYSTEM

The TQ-3 Radio System was pre-adjusted at the factory. The adjustment should be checked before running the model, in case of movement during shipping. Here's how:

1. Fully extend the chrome antenna mast on the transmitter and turn the switch on. The red indicator light on the transmitter should be solid red (not flashing).
2. Turn on the receiver switch in the model. The switch is located in the top of the radio compartment. The function light on the OptiDrive ESM should be green. A red flashing LED indicates low voltage in the RX Power Pack. The sensor LED is intermittent depending on the rotor position.
3. Position Revo so that its front wheels are off the ground.
4. Turn the steering wheel on the transmitter back and forth and check for rapid operation of the steering servo. Also, check that the steering mechanism is not loose or binding. If the steering operates slowly, then check the receiver pack to make sure it is fully charged.
5. When looking down at model, the front wheels should be pointing straight ahead. If the wheels are turned slightly to the left or right, slowly adjust the steering trim control on the transmitter until they are pointing straight ahead.

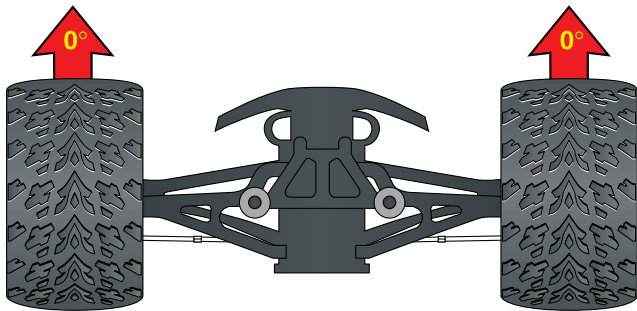

6. Operate the throttle trigger on the transmitter and check for rapid operation of the throttle servo. When the throttle trigger is pulled back, the carburetor should open (slide moves out). When the throttle trigger is pushed all the way forward, the brake should lock.
7. Operate the shift button on the transmitter and check for rapid operation of the shifting servo. Push the shift button down for forward. The servo will operate the spring-loaded shift mechanism and you will hear the transmission click into forward. Push the shift button up for reverse and you will again hear the transmission click and shift into gear.
8. Once adjustments are made, turn off the receiver on your Revo, followed by the hand-held transmitter.

## RANGE-TESTING THE TQ-3 RADIO SYSTEM

Before each running session with your Revo, you should range-test your radio system to ensure that it operates properly.

1. Turn on the radio system and check its operation as described in the previous section (Using the TQ-3 Radio System).
2. Have a friend hold the model with the engine off.
3. Make sure your transmitter antenna is fully extended, and then walk away from the model with the transmitter until you reach the farthest distance you plan to operate the model.
4. Operate the controls on the transmitter once again to be sure that the model responds correctly.
5. Do not attempt to operate the model if there is any problem with the radio system or any external interference with your radio signal at your location.

**!** When the engine is running, don't use the throttle trim on the transmitter to adjust the engine idle speed. Instead, use the idle speed adjustment on the carburetor.

**!** Don't attempt to operate your Revo if there are any problems with your radio system or radio interference at your location.

# THE TRX 2.5R RACING ENGINE



Traxxas strongly discourages changing or modifying any part of the TRX 2.5R Racing Engine. Old tech tips and tricks that may have boosted the power of other engines could seriously diminish the performance of the TRX 2.5R Racing Engine.

There's more advanced thinking, development and testing in the stock parts of your TRX 2.5R Racing Engine than in many aftermarket manufacturer's performance parts. The TRX 2.5R Racing Engine is already the most powerful engine in its class and simply will not benefit from average, low-tech, aftermarket bolt on performance items.

## INTRODUCTION

There's nothing like the TRX 2.5R Racing Engine in your new Revo. The TRX 2.5R Racing Engine is a specialty high-performance racing engine. Its impressive performance is the result of years of focused engineering development, and thousands of hours of controlled testing and rigorous real-world running. It offers unprecedented power and performance that turns ready-to-run into Ready-To-Race®.

The TRX 2.5R Racing Engine takes a total-system approach. Each part of the engine, from the air filter to the exhaust tip, is carefully engineered to work in harmony with other engine components. Each part complements the next, to extract maximum power. The TRX 2.5R Racing Engine is designed to be tolerant of variations in tuning, and to run successfully through a wide range of variable atmospheric conditions such as changes in temperature, humidity, and altitude.

In order to get the longest engine life and keep the TRX 2.5R Racing Engine in top running condition, it is very important to perform regular routine maintenance. **The number one cause of premature engine wear and failure is lack of care and maintenance!**

## BREAK IN

The TRX 2.5R Racing Engine is manufactured to exacting tolerances and requires a specially-designed break-in procedure to accomplish the final precision fitting of the internal engine components. It is very important that you follow the new break-in procedure as closely as possible to achieve the best performance and longest life from your TRX 2.5R Racing Engine. Engine break-in will take between one and two hours. Old style break-in procedures, such as idling the engine on the bench for several tanks of fuel or simply running the engine with a very rich fuel mixture for the first 4 tanks of fuel, will not achieve the best results. Follow the easy steps in this manual.

## AIR FILTER MAINTENANCE

A clean air filter is critical for long engine life. Due to the high-performance nature of the TRX 2.5R Racing Engine, a tremendous amount of vacuum is created to move a large volume of high-velocity air through the carburetor. Dirt is the worst enemy to your engine. Clean the air filter after each hour of running to prevent sucking dirt into the engine. Extra pre-lubed filter elements have been provided to encourage you to maintain your air filter.



## AFTER-RUN MAINTENANCE

Perform after-run maintenance on the engine to prevent corrosion from building up on the internal engine components. The fuel naturally attracts moisture and corrosion can build up very quickly inside the engine if it is not prevented.

A few minutes spent before and after each time you run your model will allow you to enjoy it for a long time to come. Read on for more exciting details about your new engine.

TRX 2.5R RACING ENGINE ILLUSTRATED

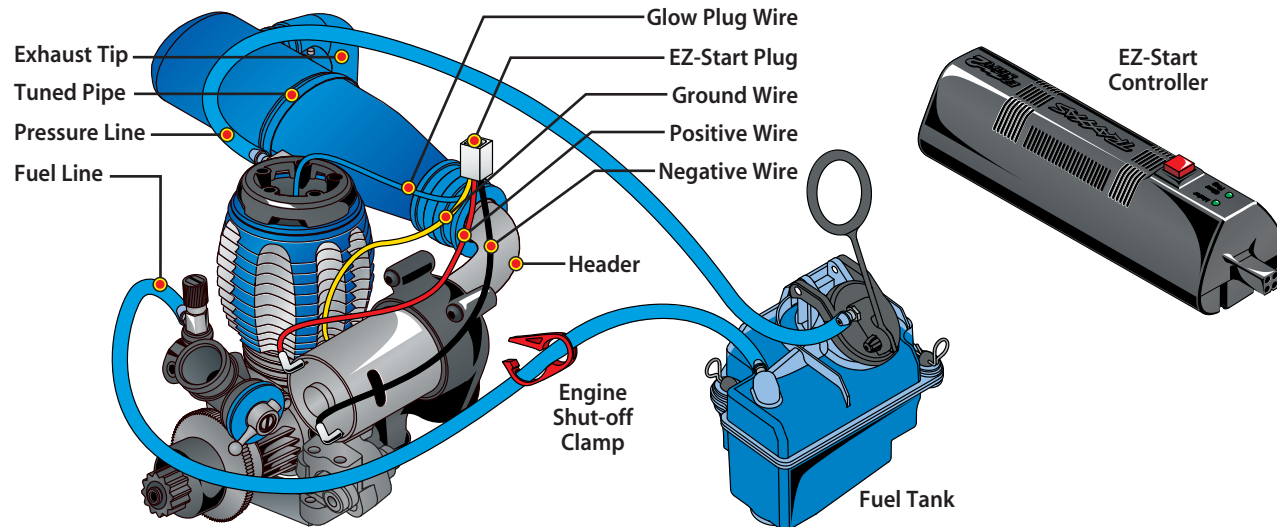
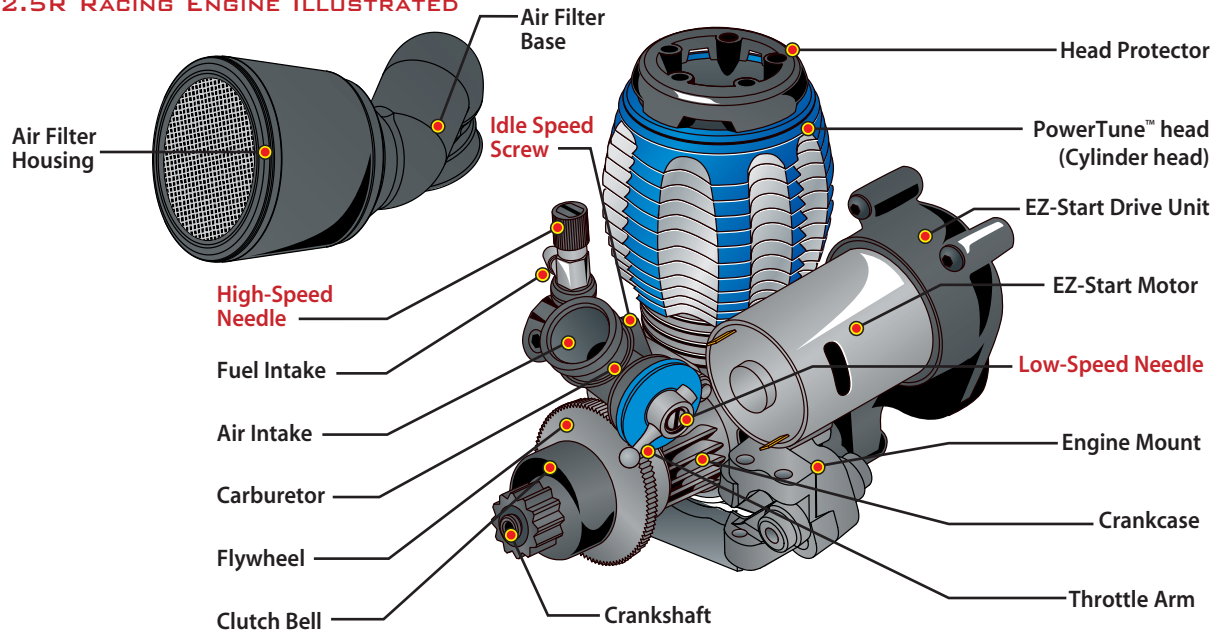

**i** Revo's fuel tank is equipped with a built-in sintered bronze fuel filter.

## TERMS TO KNOW

You'll find these Nitro R/C engine terms throughout this section of the manual.

**.15** - .15 or "15" refers to the displacement of the engine. The TRX 2.5R Racing Engine is .15 cubic inches or 2.5 cubic centimeters (cc). The name "TRX 2.5R" is derived from the cc measurement.

**ABC** - Abbreviation for aluminum, brass, and chrome. Refers to engine construction that consists of an aluminum piston that slides in a chrome-plated brass sleeve. The TRX 2.5R Racing Engine uses ABC construction.

**Air filter** - The air filter sits atop the carburetor and prevents harmful dust and dirt from entering the engine. Dirt ingestion is the number one cause of premature engine failure so the engine should never be run without the air filter in place.

**Big Block .15** - A .15 (2.5) engine that uses a larger crankcase size and longer stroke than typical .15 engines. Generally only used for specific racing classes.

**Break-in** - Break-in is the procedure for running a brand new engine according to specific instructions. This correctly prepares the engine for normal running. The break-in procedure can be different for different makes of engines. Follow the Traxxas directions for break-in exactly.

**Carb** - Abbreviation for carburetor.

**Carburetor** - The carburetor atomizes (mixes) the fuel with the air so that the engine can burn it. There are two types of carburetors, slide carbs and barrel carbs. The TRX 2.5R uses the superior slide carburetor design.

**Clean-out** - Cleaning-out is a condition that occurs when the engine is accelerating and the fuel mixture becomes sufficiently lean to allow the engine to continue into its upper RPM power band. Usually characterized by a noticeable decrease in blue exhaust smoke and a dramatic increase in engine speed.

**Combustion chamber** - The combustion chamber is machined into the bottom of the cylinder head. This is where the glow plug ignites the fuel. The shape of the combustion chamber is designed to promote more efficient burning of the fuel.

**Connecting rod** - The connecting rod transfers the piston motion to the crankshaft. The TRX 2.5R Racing Engine uses a "knife-edged" connecting rod. The aerodynamic, sharpened edges allow it to "slice" through the pressurized air/fuel mixture inside the crankcase.

**Cooling fins** - The cooling fins are molded into the cylinder head and crankcase and cause heat to be drawn away from the engine. Heat is

removed when it dissipates into the air passing across the cooling fins. It is important to keep the fins clean of dirt and debris for maximum cooling efficiency.

**Crankcase** - The engine "body" that contains all of the running mechanical components.

**Crankshaft** - The main shaft of the engine that contains the rotating assembly.

**Cylinder head (head)** - The finned aluminum part on top of the engine that is responsible for dissipating most of the engine's heat. The combustion chamber is machined into the bottom of the head.

**Damper** - Another term for shock.

**Damping** - Resistance force caused by the piston moving through the oil used to absorb bump and spring rebound energy.

**Dyno** - Abbreviation for dynamometer. A precise piece of testing equipment that accurately measures engine power and torque output over the engine's entire RPM range.

**EZ-Start** - Second generation Traxxas on-board electric starting system. The system consists of a hand held starter control unit and an on-board gearbox with an electric motor to spin the engine.

**Filter foam** - The oiled foam element inside the air filter housing. The filter foam in the TRX 2.5R Racing Engine must be thoroughly cleaned and re-oiled after every hour of run time.

**Fit** - Usually refers to the fit of the piston and sleeve. If the fit is tight, then the piston will feel very tight at top of the sleeve and the engine will have good sealing and compression. If the fit is loose, then compression will be low and the piston and sleeve should be replaced.

**Flame-out** - Occurs when the engine stops running at high RPM. Usually the fault of an excessively lean fuel mixture or glow plug failure.

**Fuel** - (10% 20%) The TRX 2.5R must have model engine fuel to run. Traxxas Top Fuel is recommended. Fuel is sold in quarts and gallons from hobby dealers. The 10 and 20% labeling refers to the percentage amount of nitromethane contained in the fuel (*see "nitro percentage" definition*).

**Fuel mixture** - The ratio of fuel to air as determined by the needle settings of the carburetor.

**Fuel tubing (fuel line)** - The thick silicone tubing that carries fuel from the fuel tank to the carburetor.

**Glow plug** - The glow plug is located in the cylinder head at the top of the combustion chamber. It contains a platinum element that glows red hot

when voltage is applied. When the engine is being started, the heat from the glow plug ignites the fuel mixture and starts the combustion process.

**Glow plug driver** - This tool clips onto the glow plug and supplies the required voltage to light the glow plug element. It is also called an igniter. EZ-Start equipped engines do not require this separate tool.

**Header** - The aluminum tube that connects the tuned pipe to the engine exhaust port. The length and diameter of the header must be carefully selected to extract the most power from the engine.

**High-speed needle** - Adjusts the carburetors fuel/air mixture at high RPM.

**Idle speed** - The speed (RPMs) the engine runs at when the transmitter's throttle trigger is at neutral.

**Idle speed screw** - Located on the carburetor body. This screw adjusts the idle RPM of the engine.

**Lean** - A running condition where the engine is not getting enough fuel (for the available air). Symptoms include engine overheating, or the engine runs for a short time and then stalls, particularly at high speed. This is a dangerous condition that should be corrected immediately or it can ruin your engine.

**Leaning the mixture** - Turning either the high speed and/or low-speed needle(s) clockwise to decrease the amount of fuel the engine receives.

**Low-speed needle** - Needle valve that controls the low-speed fuel mixture.

**Needle valve** - Valve consisting of a tapered needle that closes against a corresponding seat to regulate fuel flow.

**Nitro** - Abbreviation for nitro methane, a component of model engine fuel that improves fuel combustion and power output. Nitro also refers to a class of RC powered by model engines instead of electric.

**Nitro content** - The amount of nitro methane used in the fuel. Usually measured as a percentage of the total fuel volume. Traxxas engines are optimized to use 10-20% nitro. 30% nitro may be used for racing.

**Nitromethane** - Nitro methane is a component in the fuel that increases power from the combustion process up to a point. Engines are generally optimized to use a range of nitro content for the best power.

**O-ring** - Rubber "O"-shaped ring used as a sealing gasket.

**Pipe** - Abbreviation for the tuned exhaust pipe on a nitro engine. *See "Tuned Pipe" definition.*

**Piston** - The piston is the internal engine part that is attached to the upper end of the connecting rod and moves up and down in the cylinder sleeve. The precise fit between the piston and the sleeve creates a seal that allows

engine to have the required compression for combustion.

**Port** - Ports are openings in the sleeve that allow atomized fuel to enter the combustion chamber and burned exhaust gasses to exit. The shape and location of the ports are a large factor in controlling the engine timing and power output.

**Priming** - Manually causing fuel to move from the fuel tank up to the carburetor. This is sometimes necessary after the engine has been sitting for a long period of time and all the fuel has drained back to the tank. On a Traxxas model this is done by holding your finger over the exhaust tip for one or two seconds while the engine is starting.

**Punch** - A term that refers to how quickly the model responds to throttle input or how quickly it accelerates.

**Rich** - A running condition where the engine is getting too much fuel for the available air. It is better to run an engine slightly rich to increase engine life. Excessively rich mixtures cause the engine to have sluggish performance with exaggerated blue smoke and unburned fuel coming from the exhaust.

**RPM** - Abbreviation for revolutions per minute (how many times the engine crankshaft spins in a minute).

**Sleeve** - Internal engine part that contains the piston. The precise fit between the sleeve and the piston creates a seal that allows engine to have the required compression for combustion. The sleeve in a TRX engine is made of brass and is then hard-chrome plated.

**Slide carburetor** - The throttle on a slide carburetor closes and opens by sliding a barrel in and out of the carburetor body. This type of carburetor is preferred for performance use because it provides a less restrictive "straight-through" air path than the barrel carburetor design.

**Stall** - When the engine stops running, usually due to an incorrect fuel mixture setting or running out of fuel.

**Tuned pipe** - The tuned exhaust pipe usually consists of a specially-shaped metal or composite chamber with baffles that is designed to enhance the power output of the engine.

**Wear-in** - Fitment process that occurs during engine break-in where internal engine parts develop an even more precise matched fit through actual use under controlled circumstances.

**WOT** - Abbreviation for wide-open throttle.

**!** DANGER! Model engine fuel is poisonous to humans and animals. Drinking the fuel can cause blindness and death. Handle with care and respect. Keep it out of reach of small children at all times! While driving, do not leave your fuel dispensing bottle on the ground where a child could have access to it. Follow fuel label warnings.

**!** You may use higher nitro percentages than 20% in certain circumstances. Call 1-888-TRAXXAS for more information.

## THE FUEL

### Use the Right Fuel

It's imperative that you use the correct fuel in your TRX 2.5R Racing Engine for maximum performance and engine life. Traxxas Top Fuel™ should be used to ensure correct engine lubrication, performance, and ease of tuning. Traxxas Top Fuel has been proven in thousands of engines, so you can count on it every day for great performance.



- ☉ Top Fuel is the only fuel which is 100% certified for use in Traxxas engines.
- ☉ Traxxas Top Fuel is made with just the right balance of the highest grade natural and synthetic lubricants to allow excellent throttle response and the best top-end performance, without sacrificing long-term durability.
- ☉ All of the components in the fuel are carefully selected from the best materials available and then custom blended to match the metallurgy and temperature characteristics of Traxxas engines.

You may use 10% or 20% nitro-content fuel. Use the same percentage all the time; don't switch back and forth between 10% and 20% fuel. If you break-in your engine on 20% fuel, then always use 20% fuel.

### What about Other Fuels?

Can other brands of fuel be used besides Top Fuel? There are other fuels that can provide satisfactory performance; however there could be long-term costs in the form of decreased engine performance, loss of tuning ease, and shorter engine life. Only use fuels that contain both castor and synthetic oil.

Everyone has an opinion or a claim to make about fuel. The engineering team at Traxxas spent over 2-years developing the TRX 2.5R Racing Engine. No one knows more about the specific fuel requirements of Traxxas engines, than Traxxas engineers. We strongly urge you not to take chances with your engine investment and use the Traxxas fuel made for the TRX 2.5R Racing Engine.

### Handling the Fuel

- ☉ Follow all directions and warnings on the fuel can.
- ☉ Keep the fuel tightly capped at all times. Some components in the fuel can evaporate very quickly and upset the balance of the fuel.
- ☉ Do not store unused fuel in the fuel dispenser. Immediately return fresh unused fuel back into the fuel can.
- ☉ Do not mix old and new fuel. Never mix different brands of fuel together.
- ☉ Store the fuel in a cool dry location, away from any source of heat, ignition, or combustion.
- ☉ Read and follow the safety precautions on page 4 in this manual.

### Filling the Fuel Tank

Use a fuel dispensing bottle (Traxxas Top Fueler, part #5001) to put fuel into Revo's fuel tank. To fill the fuel bottle, squeeze the air out, insert the dispenser tip into the fuel can, and release your grip on the bottle. As the bottle expands, fuel will be drawn into it.

To fill your model, pull up on the fuel cap handle, insert the tip of the fuel bottle, and squeeze to dispense the fuel.

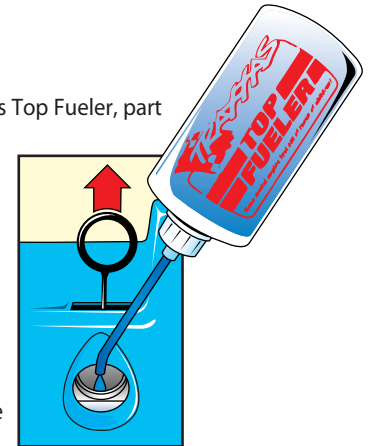

## THE AIR FILTER

The TRX 2.5R Racing Engine air filter is specifically designed to deliver maximum performance while protecting your engine from dust and dirt. Use only the supplied filter. **You will not improve engine performance by switching to an aftermarket filter**, and you may risk engine damage due to poor filtration.

The TRX 2.5R Racing Engine air filter assembly consists of 3 pieces:

1. A rubber filter base
2. A plastic housing consisting of a permanently assembled mesh cap and body
3. An oiled foam element

**You must clean the filter after every hour of run time, even if the filter looks clean. This includes the break-in time. Clean your air filter after break-in.** Dust (which is often too fine to see) and dirt constantly move through the filter anytime the engine is running. Even if you can't see dirt on the filter, it is present inside the foam after any amount of run time. If you exceed the recommended cleaning intervals, your engine will be damaged. Engine damage or wear due to dirt ingestion is easy to detect, and one of the top causes of premature engine failure.

### Air Filter Cleaning Instructions

1. Remove the air filter from the carburetor bore by pulling the entire filter assembly firmly to the side to release it. **Do not pull straight up.**
2. Disassemble the filter. Pull the rubber air filter neck out of the filter body. With the base removed, the foam element is visible in the bottom of the filter body. Pull out the foam element.
3. Clean the filter parts by thoroughly washing all three pieces of the filter assembly in hot soapy water (dishwashing detergent works well). Repeat twice.
4. Thoroughly dry the parts with a clean towel or compressed air. Remember to wear your safety glasses when working with compressed air.

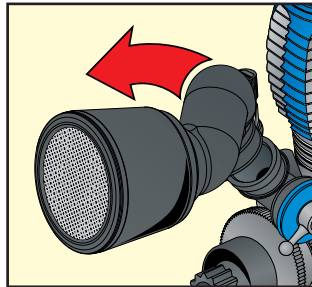

5. Oil the foam element with foam filter oil. Use the supplied Traxxas filter oil (part# 5263) or a high-quality, special-purpose foam filter oil like what is used for off-road motorcycle and ATV engines. This type of filter oil is available at motorcycle pro-shops. Apply 30 drops of the Traxxas filter oil evenly to the top, bottom and sides of the filter element (30 total drops divided among the 3 surfaces). Squeeze the filter element repeatedly to help spread the oil throughout. The filter element should be evenly colored by the oil. Even color indicates that the oil is distributed evenly. **Do not** squeeze out excess oil. **Note: Do not use the air filter oil for anything other than the air filter. It is not meant to be a lubricant.**
6. Reassemble the filter and install it on the engine, making sure the rubber filter neck fits securely on the carburetor with no gaps or air leaks.

**!** Clean your air filter after every hour of run time to avoid engine damage, even if the filter looks clean.

**!** If you use compressed air to dry your air filter assembly, wear safety glasses and avoid directing compressed air toward your skin.

**i** If foam filter oil is not available, clean 30 or 40 weight motor oil can be substituted, but is not preferred. Never run the engine without a properly oiled filter!



See page 31 for more information on how air density affects engine tuning.

## THE CARBURETOR

### Understanding the Carburetor adjustments

The carburetor performs several functions. It controls the engine's speed by restricting the intake of air and fuel into the engine. It atomizes the fuel (suspends the fuel droplets in the air) and also controls the air/fuel ratio of the mixture entering the engine (how much air for a given amount of fuel).

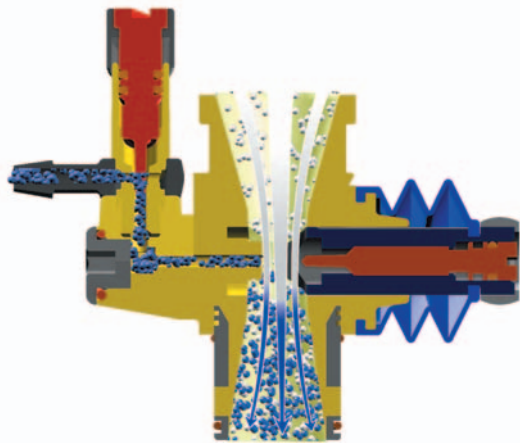

To help provide a better understanding of engine tuning and why it's necessary, the following is a brief explanation of the air/fuel combustion process that takes place inside the engine.

In order to create the cylinder pressure that results in power, the engine burns the air/fuel mixture. Both air and fuel, in correct amounts, are needed for proper combustion. It is the carburetor's job to mix the air and fuel together (atomize the fuel), in the correct proportion for the best possible combustion. This is the ideal air/fuel ratio. The ideal air/fuel ratio required for the engine remains roughly constant. Due to variations in atmospheric conditions (temperature, humidity, altitude etc.) fuel flow adjustment valves (called fuel mixture needles) are required to meter the fuel and maintain the ideal air/fuel ratio in these ever-changing conditions. For example, colder air is more dense (more air molecules) for a given volume of air and therefore requires more fuel (more fuel

molecules) to maintain the correct air/fuel ratio. Warmer air is less dense (fewer air molecules) and therefore needs less fuel to maintain the correct air/fuel ratio. The tuning needles are there to adjust how much fuel is made available for the carburetor to mix with the available air (atomization).

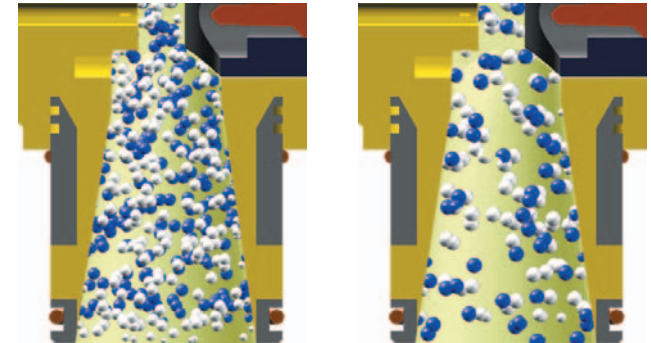

### THE FUEL MIXTURE NEEDLES

The amount of fuel metered and atomized by the carburetor is controlled by the two mixture needles, the high-speed needle and the low-speed needle. The low-speed needle is used to meter the fuel used by the engine at idle and low RPM (part-throttle) engine speed. The high-speed needle is used to meter the fuel when the throttle is open from part throttle to wide-open throttle (WOT). Two needles on the TRX 2.5R Racing Engine provide precise control of the air/fuel ratio across the engine's entire RPM range.

The maximum possible fuel flow is always controlled by the high-speed needle. It works like the main water valve on a garden hose. Turn it clockwise to close the valve, counter-clockwise to open it. When the throttle is at idle or partially open, the low-speed needle again meters the fuel flow at the outlet (needle seat) where the fuel enters the carburetor venturi. This second valve acts like the spray nozzle at the end of the garden hose in our example. When you accelerate from idle, the throttle opens and the low-speed needle is pulled away from the needle seat. This allows more fuel to flow with the increased air flow. As the



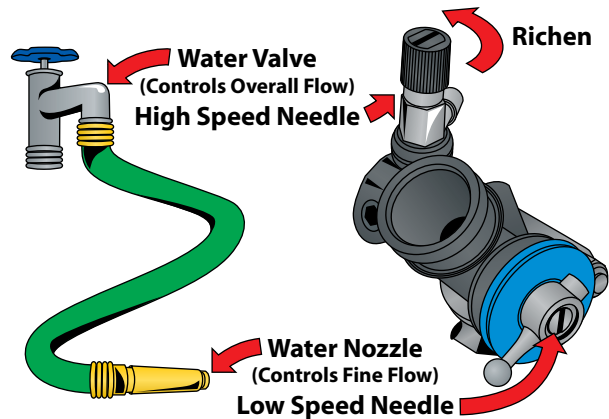

- ☉ Slightly lean fuel mixtures deliver stronger, more efficient combustion and more power, but with less lubrication.
- ☉ Slightly rich fuel mixtures deliver cooler running and more lubrication but with slightly less power.

Tuning the engine means finding the perfect balance between the two; excellent power to meet your needs while maintaining good lubrication for long engine life. **The optimal fuel mixture setting is rich** to provide a safety margin against having a lean condition if some variable changes (such as the temperature from one day to the next).

General fuel mixture settings are measured by the number of turns the needles are turned out from fully closed. The fuel mixture settings have been pre-set from the factory to typical break-in settings. Do not readjust your carburetor from the factory settings until after the engine is started and running, and you have been able to observe the engine running to assess what minor adjustments may be required to compensate for fuel, temperature, and altitude. Adjustments are usually made in 1/8 or 1/16-turn increments.

### The Idle Speed Adjustment

The idle speed screw controls the closed position of the throttle slide. When the throttle servo is in its neutral position, the throttle slide should be stopped against the idle adjustment screw. Always use the idle speed adjusting screw to control engine idle. Do not use the throttle trim on the transmitter to adjust idle speed. The idle speed should be set as low as possible and still maintain reliable running.

throttle is increased, the low-speed needle is pulled completely away from the needle seat leaving it fully open. At that point, fuel metering is entirely controlled by the high-speed needle. Again, using our water hose example, when the spray nozzle at the end of our garden hose is fully open, then the main water valve can be used to adjust how fast the water flows.

The engine's performance is directly linked to the fuel mixture. Richening the fuel mixture increases the amount of fuel in the air/fuel mixture ratio and leaning the fuel mixture decreases the amount of fuel in the air/fuel mixture ratio.

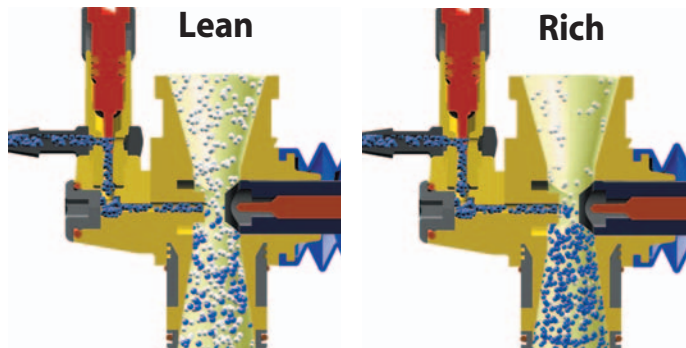

➔ See *Tuning Your TRX 2.5R Racing Engine* on page 30 for complete information on adjusting the air/fuel mixture and idle speed.

**i** **Factory Needle Settings**  
If your factory preset carburetor adjustments have been tampered with, use the following settings:

- Set the high-speed needle to 4 turns out from closed.
- Set the low-speed needle so the screw head (red in Fig. A) is flush (even) with the end of the slide (yellow in Fig. A).

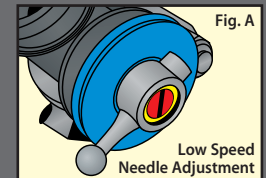

Always use the factory settings for initial starting. Only use these settings when the factory settings have been lost.



### Use the Right Charger

The most convenient type of charger is an AC peak-detecting charger that plugs directly into an AC wall outlet. It contains special peak-detection circuitry that automatically shuts the charger off when the battery is fully charged.

If you're using a 15-minute timed charger, always fully discharge the battery pack before each charge. Some high mAh battery packs (1500 mAh or higher) require more than the standard 15 minutes of charge time. If the battery pack is cold after 15 minutes of charging, add another 5 minutes of charge time. Closely monitor the battery pack and stop charging it when it begins to feel warm to the touch. Never leave a battery charging unattended. Always follow charger manufacturer's instructions.

Inexpensive overnight wall chargers may also be used.



## THE TRAXXAS EZ-START ELECTRIC STARTING SYSTEM

The Traxxas EZ-Start brings the convenience of push-button electric engine starting to your Revo. The EZ-Start consists of a hand-held control unit and an on-board motorized starter.

- Power for the EZ-Start system comes from a 7.2-volt rechargeable battery pack installed in the hand-held control unit (battery not included).
- The engine glow plug is heated automatically by the EZ-Start system, eliminating the need to keep up with a separate glow plug igniter.
- The voltage to the glow plug is kept constant, regardless of the load placed on the starter by the starter motor.
- The "Glow Plug" LED (light emitting diode) on the control unit indicates the condition of the glow plug.
- The "Motor" LED indicates the status of the EZ-Start electric starter motor.
- The cush drive mechanism in the drive unit prevents damage to the gears caused by engine kickback.
- Smart Start™ protection circuitry prevents damage to the motor by cutting power if the load on the motor or other electronics exceeds safe limits.

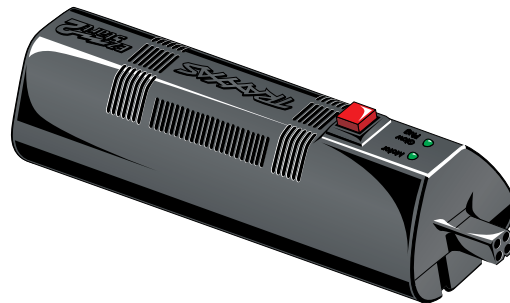

### Installing the EZ-Start Battery

The EZ-Start system requires a fully charged 7.2-volt rechargeable NiCad or NiMh battery pack (not included). Use a charger (not included) designed for 7.2-volt battery packs. Charge the battery according to the charger manufacturer's directions.

1. Press the tab in the end of the battery compartment door to open.
2. Plug a fully charged 7.2-volt battery pack into the connector inside.
3. Twist the battery 2 or 3 times to twirl the battery plug wires. This helps hold the wire and battery in place when the battery is installed in the compartment.
4. Install the battery into the compartment and press the wires securely into place.
5. Snap the battery compartment door back on and lock the end tab.

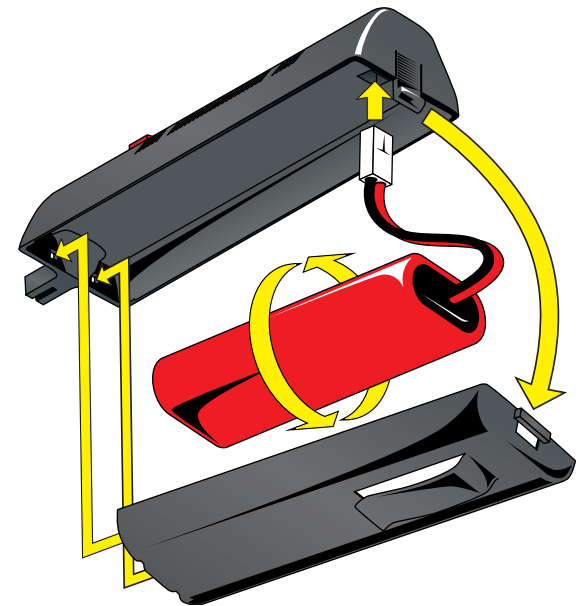

## Using the EZ-Start

Your EZ-Start controller plugs into a 4-prong receptacle in the center of the pickup bed on your Revo. When the red button on the controller is pressed, the EZ-Start motor begins to spin the engine and power from the control unit heats the glow plug. Assuming all settings and preparations are correct, the engine should start almost immediately.

Each of the two status indicator LEDs on the hand-held control unit, the **Motor** LED and the **Glow Plug** LED, should light green while starting. If either LED fails to light while starting, there is a fault indicated with that function:

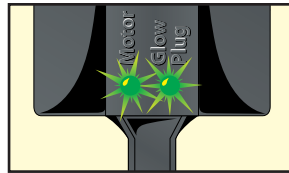

- ☉ If the **Glow Plug** LED fails to light, the glow plug may be bad, or the glow plug wire may be damaged or disconnected.

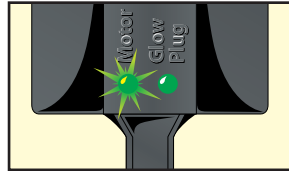

- ☉ If the **Motor** LED fails to light and the starter fails to operate, then the EZ-Start is in protection mode.

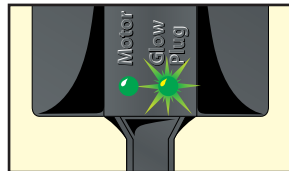

## Protection Mode

The EZ-Start uses Smart Start™ technology to monitor the condition of the system and detect failures. The controller monitors the load being placed on the EZ-Start motor. If the load becomes excessive, the system shuts off power to the motor to prevent costly damage to the motor and the controller. This may occur, for example, if the engine floods with fuel during starting. The starter spins at first but when excessive fuel in the combustion chamber begins to lock up the engine, the starter motor slows under the heavier load. This causes the protection circuit to shut off the power to the motor. Allow at least 3 minutes for the starter motor to cool and the circuit to automatically reset before continuing. Use the time to find and eliminate the condition that caused the excessive load on the starter motor.

## Shutting Off The Engine

Turning off the switch for the radio will not shut off the engine. To shut off the engine, use the shut-off clamp on the fuel line. Simply squeeze the clamp closed to shut off the fuel supply to the engine. Don't forget to release it when you restart the engine.

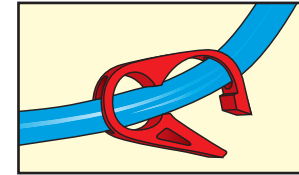

Avoid shutting off the engine by placing your finger over the exhaust outlet, especially if you are through driving for the day. This will leave more unburned fuel in the engine that could lead to harmful corrosion. **Always be careful not to touch the metal exhaust pipe after running, it can become very hot.**

## Clearing a Flooded Engine

If the engine is primed for too long during startup, then it can become flooded with fuel. When the engine is flooded it will no longer turn due to excess fuel in the combustion chamber preventing upward movement of the piston. Use the following procedure to clear a flooded engine.

1. Remove the blue glow plug wire.
2. Remove the glow plug and gasket with the glow plug wrench supplied with your model. A 5/16 nut driver will also work.
3. Turn the model upside down and plug in the EZ-Start controller.
4. Push the EZ-Start button for several seconds to clear the engine of excess fuel.
5. Turn the model over and reinstall the glow plug and gasket.
6. Reconnect the blue glow plug wire to the glow plug.
7. Reconnect the EZ-Start controller
8. Do not prime the engine. Pull the throttle to 1/2 throttle and push the EZ-Start button. The engine should start immediately.



When the EZ-Start controller is in protection mode, wait at least three minutes before attempting to start the engine, to give the starter motor time to cool.



It's normal for your EZ-Start controller to become warm after repeated use.



See Important Points to Remember on page 4 for other precautions.



Never run your Revo indoors. Since the TRX 2.5R Racing Engine exhaust fumes are harmful, always run your Revo outdoors, in a well-ventilated area.



Your TRX 2.5R Racing Engine doesn't usually require priming. If you do need to prime your engine, watch the fuel line carefully to avoid flooding your engine. See page 27 for information on clearing a flooded engine.



#### Factory Needle Settings

Your carburetor is preset at the factory to give the correct air-to-fuel ratio and idle speed for engine break-in. Do not adjust the carburetor unless you observe a poor running condition that requires correction (see page 25 for stock settings).



## BREAKING IN YOUR TRX 2.5R RACING ENGINE

The TRX 2.5R Racing Engine uses a ringless, aluminum-brass-chrome (ABC) piston/sleeve construction. This type of engine design relies on a very precise running fit between the piston and sleeve for cylinder sealing. **Engine break-in is necessary to allow the piston and sleeve to develop an extremely precise fit and optimum cylinder sealing. Therefore, proper engine break-in is critical to achieving the fastest, most reliable engine performance.**

Allow yourself about 1 to 1½ hours to complete the break-in procedure. The engine break-in period will take 5 tanks of fuel in a Revo. The break-in time is not the time to impress your friends with your new Revo. **You must wait until the engine is fully broken in before attempting sustained high speed running.** Patience and careful attention during break-in will reward you with the best-performing TRX 2.5R Racing Engine possible.

During break-in, your engine may appear to malfunction with symptoms like stalling, inconsistent performance, and fouled glow plugs. These are simply the normal "break-in pains" engines sometimes go through. They will disappear once your engine is fully broken in. Many owners report not experiencing any of these symptoms with the TRX 2.5R Racing Engine. **We recommend to go ahead and replace the glow plug with a new one after the engine break in procedure.**

### Engine Break-in Procedure

The focus during break-in is to vary and limit the engine speed. This will be accomplished by accelerating and stopping at different rates for the first 5 tanks of fuel. As the engine begins to break-in, the duration and intensity of the acceleration will gradually increase. **Sustained high-speed running is not permitted until the 6th tank of fuel.** Perform the initial break-in on a large, flat, paved surface. **Apply all throttle and braking actions gently. Abrupt acceleration or braking could cause the engine to stall unnecessarily.**

- ⦿ Special break-in fuels are not recommended. Use the same fuel you plan to use everyday.
- ⦿ If possible, avoid breaking-in the engine on extremely hot or cold days (see page 32).
- ⦿ Pay careful attention to the fuel level. Do not allow the fuel tank to run completely empty. An extremely low fuel level causes the mixture to run too lean. This could result in a burned glow plug or extremely high engine temperatures.

- ⦿ **Do not** attempt to break in the TRX 2.5R Racing Engine by idling it on a stand. This will produce poor results.
- ⦿ Keep extra Traxxas glow plugs (part #3231 or 3232) handy. The break-in process can cause deposits to form on the plug leading to plug failure.
- ⦿ Change or clean your air filter after break-in.
- ⦿ Follow the instructions exactly for each of the first 5 tanks of fuel.

### Starting Your TRX 2.5R Racing Engine for the First Time

Before you start your TRX 2.5R Racing Engine for the first time, make sure you have read all instructions and precautions in this manual. **Pay close attention to the tank-by-tank break-in instructions in the next section, and make sure you have read and understood them before you run your engine.**

**Your engine must be at room temperature (70°F or 21° C) or above the first time you start it.** If it's cooler than room temperature outside, keep your Revo indoors until you're ready to start it and then take it outside. If it's colder than 45 degrees, special considerations should be made. See cold weather break-in on page 32. We do not recommend running the model in temperatures below 35 degrees.

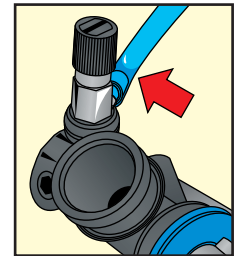

1. Turn on the radio system (see page 16).
2. Make sure the throttle trigger on the transmitter is in the idle (neutral) position.
3. Connect the EZ-Start controller according to the instructions on page 27.
4. Press the starter button in short two second bursts and watch for fuel moving through the fuel line up to the carburetor. Watch closely! The fuel moves very fast. If the fuel doesn't move through the line within 5 seconds, prime the engine by briefly (one or two seconds) covering the exhaust outlet with your finger until the fuel is just visible in the carburetor fuel line. **Watch carefully! If the engine is primed too long, it will flood with fuel and stop turning.**
5. Once fuel reaches the carburetor, the engine should quickly start and idle.
6. Disconnect the EZ-Start controller from the model.
7. Proceed with the engine break-in.
8. Do not rev your engine with no load (wheels off the ground).

If your engine doesn't start, refer to the TRX 2.5R Racing Engine troubleshooting section at [www.Traxxas.com](http://www.Traxxas.com). If you still have problems, contact Traxxas Customer Support at 1-888-TRAXXAS.

**Tank 1**

1. Drive the model with the **body off**.
2. Driving procedure: **Gently pull the throttle trigger to 1/4 throttle over a 2-second count. Then gently apply the brake to stop.** Count the two seconds out while accelerating: one thousand one, one thousand two, and then stop. Operate the throttle trigger as smoothly as you can. **Repeat this starting and stopping procedure until the first tank of fuel is nearly empty.**
3. Look for thick blue smoke exiting the exhaust outlet. If there is no smoke, richen the high-speed needle 1/4 turn, by turning the needle counterclockwise.
4. When the fuel tank is nearly empty, shut off the engine by pinching the fuel line connected to the carburetor (use the installed clamp).
5. Let the engine cool for 15 minutes.

Note: If at any point the engine cuts out or stalls during gentle acceleration, richen the high-speed needle 1/4 turn by turning the needle counterclockwise.

**Tank 2**

1. From tank 2 forward, Revo should be driven **with the body on**.
2. Driving procedure: **Gently pull the throttle trigger to 1/2 throttle over a 2-second count. Then gently apply the brake to stop.** Count the two seconds out while accelerating: one thousand one, one thousand two, and then stop. **Repeat this starting and stopping procedure until the second tank of fuel is nearly empty.**
3. When the fuel tank is nearly empty, shut off the engine and let it cool for 15 minutes.

**Tank 3**

1. Driving procedure: **Gently pull the throttle trigger to 1/2 throttle over a 3-second count. Then gently apply the brake to stop.** Count the three seconds out while accelerating: one thousand one, one thousand two, one thousand three, and then stop. **Repeat this starting and stopping procedure until the third tank of fuel is nearly empty.**

2. As the engine loosens, the idle speed may increase and cause the model to try to creep forward when stopped. Reduce the idle speed by turning the idle adjustment (see page 19) on the carburetor counterclockwise.
3. When the fuel tank is nearly empty, shut off the engine and refuel. From here on, you do not need to let the engine cool between tanks.

**Tank 4**

1. Driving procedure: **Gently pull the throttle trigger to full throttle over a 3-second count. Then gently apply the brake to stop.** Count the three seconds out while accelerating: one thousand one, one thousand two, one thousand three, and then stop. **Repeat this starting and stopping procedure until the fourth tank of fuel is nearly empty.**
2. Apply the throttle gradually! Your finger should not reach full throttle until the end of the three-second count. Revo may try to shift into second gear. If it does, reduce the throttle input. Do not let Revo shift out of first gear.
3. Keep your driving smooth and consistent.
4. When the fuel tank is nearly empty, shut off the engine and refuel.

**Tank 5**

1. Driving procedure: **Gently pull the throttle trigger to full throttle over a 3-second count, hold for 2 more seconds, and then gently apply the brake to stop.** Count the five seconds out while accelerating. **Repeat this starting and stopping procedure until the fifth tank of fuel is nearly empty.**
2. The model should now be shifting into second gear. If it is not, try turning the high-speed needle clockwise 1/8 turn to lean the fuel mixture slightly and test for shifting.
3. When the fuel tank is nearly empty, shut off the engine and refuel.

**Tank 6**

**STOP!** Clean your air filter before you proceed. Refer to the instructions on page 23. During the sixth tank of fuel, the engine can be tuned for general performance use. Proceed to the next section in this manual.

TANK	THROTTLE	TIME	COOL	BODY	NOTES
1	1/4	2 Seconds	15 Minutes	Off	Apply throttle gradually.
2	1/2	2 Seconds	15 Minutes	On	Apply throttle gradually.
3	1/2	3 Seconds	-	On	Reduce idle speed if necessary.
4	Full	3 Seconds	-	On	Do not allow shifting to high gear.
5	Full	5 Seconds	-	On	Accelerate over 3 second count, hold for 2 seconds.



**High Altitude Operation:** If you live in a high altitude region (5000 or more feet above sea level), the lower air density may require you to lean your high-speed fuel mixture slightly from the factory break in settings. Try this if you are experiencing difficult starting or extremely sluggish engine performance at high altitude.



As you gain experience in the hobby, you may discover that many people have differing opinions on what is the proper procedure to break-in a model engine. *Only use the Traxxas break-in procedure. Other break-in procedures could result in a weak, damaged, or otherwise poor performing engine.* The procedure outlined here was extensively tested and proven to yield better performing engines than other "common" break-in methods. Even if you have years of experience using model engines, please do not ignore this caution!



When tuning for performance, watch closely to notice when there is no longer any increase in speed or power when the high-speed mixture is lean. If you lean the high-speed mixture to the point that the engine cuts-out, hesitates, or stalls, you are well into the danger zone and engine damage is likely. Richen the high-speed needle 1/4 turn and retune.



For your convenience, the low-speed needle has a positive stop that prevents it from being over tightened and damaging the needle and seat. This also provides an easy way to gauge how many turns out from closed the low-speed needle adjustment is set to.

## TUNING YOUR TRX 2.5R RACING ENGINE

The engine's performance depends on the fuel mixture. Turn the mixture needles clockwise to lean the fuel mixture and counterclockwise to richen it. Leaning the fuel mixture will increase engine power up to the engine's mechanical limits. **Never run the engine too lean (not enough fuel flow). Never lean the engine until it begins to cut-out or stall.**

**Leaning the engine beyond the safe allowable limits will result in poor performance and almost certain engine damage.** Indications of an overly lean mixture include:

- ☉ **Cutting out or sudden loss of power during acceleration.**
- ☉ Overheating (temperature beyond 270° F at the glow plug)
- ☉ Little or no blue smoke coming from the exhaust.

If any of these conditions are present, stop immediately and richen the high speed mixture 1/4 turn. The engine will probably be slightly rich at that setting and you can then retune for performance. Always tune for performance by starting rich and moving leaner toward the ideal setting. Never try to tune from the lean side. There should always be a light stream of blue smoke coming from the exhaust.

Before you begin tuning, the engine should be warmed up to its normal operating temperature and running slightly rich. All final tuning adjustments must be made to the engine at its normal operating temperature. You can tell the engine is running rich by noting any of the following:

- ☉ Sluggish acceleration with blue smoke coming from the exhaust.
- ☉ Revo may not shift into second gear
- ☉ There is unburned fuel spraying from the exhaust tip
- ☉ Leaning the high-speed fuel mixture increases performance

### High-Speed Fuel Mixture Adjustment

With the engine warm and running at a rich setting, gradually lean the high-speed fuel mixture in 1/16 turn increments. Make several high-speed passes with Revo after each adjustment to clear out the engine and note any change in performance. The TRX 2.5R is extremely powerful. Remember to apply the throttle gradually to prevent wheelies

or loss of control. Continue this procedure until there is no longer any performance improvement. **If any one of the following conditions occurs, the fuel mixture is already past the maximum safe lean setting:**

1. There is no longer any performance improvement
2. The engine begins to cut out at high speed (**Danger!**)
3. There is a sudden loss of power during acceleration (**Danger!**)
4. The engine begins to overheat. Symptoms of overheating include:
  - ☉ Steam or smoke coming from the engine (not exhaust)
  - ☉ Hesitation or stalling during acceleration
  - ☉ Popping or clattering sound when decelerating (detonation)
  - ☉ Fluctuating idle speed
  - ☉ Temperature measurement above 270° F at the glow plug

Richen the fuel mixture to the optimum setting by richening the high-speed needle at least 1/8 turn counterclockwise and retest. This setting will extend engine component life.

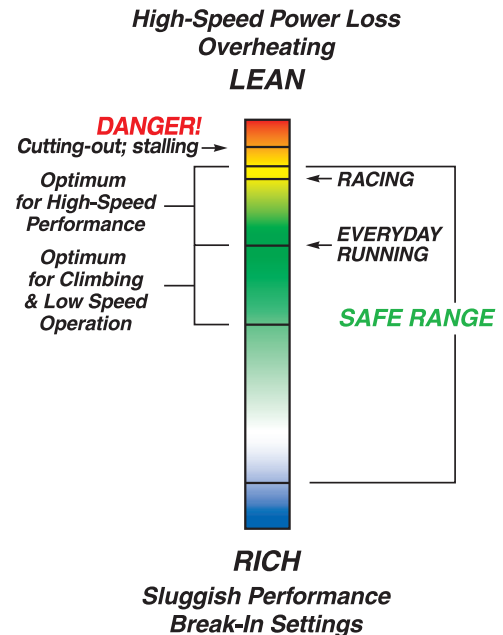

### Low-Speed Fuel Mixture Adjustment

The low-speed mixture is always set after the high-speed needle is correctly adjusted. The low-speed mixture is set using the pinch test.

1. Once the engine is warm, do several high-speed runs to confirm that the high-speed needle is set correctly.
2. Bring the vehicle in and pinch closed the fuel line going into the carburetor (use the engine shut-off clamp). The engine should run for 2-3 seconds, speed up, and then shut off.
3. If the engine runs longer than 3 seconds, then lean the low-speed needle 1/16 turn, make several more high-speed runs, and retest.
4. If the engine shuts off immediately without speeding up, then richen the low-speed needle 1/8 turn, make several more high-speed runs, and retest.

When the low-speed needle is set correctly, the engine's throttle response should be very quick, possibly even to the point of making it difficult to keep Revo from doing a wheelie when you accelerate!

### Idle Speed Adjustment

Once the high and low-speed mixtures have been set, reduce the idle speed to the minimum reliable idle speed. Remember, this adjustment should be made while the engine is running at normal operating temperature.

1. Turn the throttle trim on the transmitter so that the brakes are applied (note its original position). This ensures that the throttle slide is resting against the idle adjustment screw.

2. Turn the screw counterclockwise to reduce the idle speed, or clockwise to increase it. The idle speed should be set as low as possible while still maintaining reliable running characteristics.
3. Reset the throttle trim on the transmitter to its original position.

### Fine-Tuning the Carburetor

After fine-tuning your TRX 2.5R Racing Engine at the end of the break-in procedure, no major adjustments to the fuel mixture are usually necessary. Make note of the temperature, humidity, and barometric pressure at the time you finished fine tuning your carburetor. Current weather conditions can be found online from national websites, local TV news websites, and television. This information will be considered your baseline setting.

You may need to adjust your carburetor needles to compensate for changes in temperature and barometric pressure (air density) from day to day. Generally, you'll need to richen the fuel mixture when the weather is colder than your baseline temperature and the air density is higher. Lean the fuel mixture when weather is warmer than your baseline temperature and the air density is lower. The chart below provides general guidelines on how weather conditions affect air density when they move higher or lower than your baseline setting (see page 24 for detailed info on how air density affects mixture settings).

IF THE...	IS..	THEN THE AIR DENSITY IS...	ADJUST (CORRECT) THE FUEL MIXTURE TO BE...
Humidity	Lower	Slightly more dense	Slightly richer
	Higher	Slightly less dense	Slightly leaner
Pressure (barometer)	Lower	Less dense	Leaner
	Higher	More dense	Richer
Temperature	Lower	More dense	Richer
	Higher	Less dense	Leaner
Altitude	Lower	More dense	Richer
	Higher	Less dense	Leaner
Nitro %	Lower		Leaner
	Higher		Richer

**!** When adjusting the low speed fuel mixture, it is very important to make several high-speed runs with Revo between adjustments to clear out any excess fuel. Perform the pinch test immediately after. If the engine is allowed to idle for a long period of time, it could "load up" with fuel and give you an inaccurate measurement from your pinch test.

### Winter Break-in Tips

During the break-in process, the piston and sleeve wear into each other to form a precise fit. The engine needs to heat up to a temperature around 200 to 215 degrees to allow the piston and sleeve to achieve this fit properly. A precise fit between these two components is critical for proper compression, and optimum performance. If the engine runs too cold during break-in, the piston and sleeve will not expand to their appropriate sizes for break-in, and this can lead to premature wear of these components. This wear may not become apparent until after winter has past, and the engine is operated under warmer running conditions.

- ☉ Warm the engine to approximately room temperature with a heat gun, or keep the vehicle inside at room temperature just before starting the engine. The engine can become difficult to start in cold weather.
- ☉ After the engine is running, it is important to keep the temperature of the engine up around 200 to 215 degrees during break-in. In weather below 45 degrees, the TRX 2.5R Racing Engine will tend to run at lower temperatures between 160 to 180 degrees (when tuned at proper break-in mixture settings). This is too cool for break-in. **Do not lean the engine to increase engine temperature!** This will also decrease lubrication and cause your piston/sleeve to wear prematurely.
- ☉ Wrap the cooling head with a paper towel, clean rag or sock to help keep the engine running around the recommended 200 to 215 break-in temp. If too much heat is contained, the engine can actually run too hot. Make sure that you monitor the engine's temp closely for the first couple of tanks until you get the right amount of cover for the cooling head. This will, of course, depend on your current weather conditions. Adjusting the cover up and down, exposing more or fewer cooling fins, is a convenient way to regulate engine temps.
- ☉ For owners that do not have access to a temperature probe, a drop of water on the cooling head (around the glow plug area) should slowly sizzle for approximately 6 to 8 seconds around 200 to 210 degrees. If the water sizzles for only a few seconds, then it is likely that it is over 220 degrees, and needs to cool down. If the water takes a long time or does not evaporate at all, then the engine is too cool.

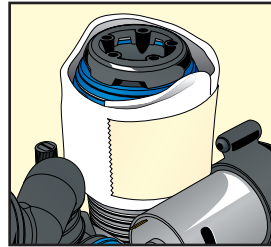

- ☉ We do not recommend that you operate your engine below 35 degrees Fahrenheit. If you insist on running your vehicle below 35 degrees, just make sure you are aware that nitro engines may be very difficult to start and tune at those extremely cold temperatures. Also, at temperatures below freezing, nitro fuel can actually begin to gel up, and this can be harmful to the engine.

Follow the remaining break-in procedures as outlined in this owner's manual. This, along with the steps listed above, will ensure a good break-in for your new nitro engine, and provide many hours of enjoyment.

### Tuning the Engine by Temperature

The following procedures require an optional infrared temperature probe or on-board temperature gauge (Traxxas on-board digital temperature gauge, part #4090 or #4091). Engine temperature can be used as an effective tuning aid when you understand the relationship between engine temperature and ambient temperature. The engine operating temperature, when tuned for maximum performance, will vary according to atmospheric conditions. The atmospheric condition that has the most influence on engine temperature is air temperature. Expect the engine temperature to vary almost in direct proportion to air temperature. Assuming you tuned the engine for the same maximum performance each day, the engine will run about twenty degrees hotter when it's ninety degrees outside than it would in seventy-degree weather. For this reason, we cannot give you a definitive temperature range that indicates the best possible engine tuning. The temperature gauge can aid you in tuning by giving you a relative indication of how your adjustments are affecting the engine and by preventing you from exceeding maximum engine temperature. For example, as you lean the fuel mixture, the engine performance will increase along with the temperature. If you continue to lean the fuel mixture and the temperature increases but the engine performance does not change, then you have exceeded the maximum safe lean setting. Even if it's 100°F outside, you should be able to tune for maximum performance. Try to keep your engine from exceeding 270°F when measured at the glow plug. If tuning for maximum performance results in engine temperature exceeding 270°F, try to increase airflow to the engine by cutting out the rear of the body, windshield, and front valance. If the engine temperature still cannot be kept below 270°F, richen the high-speed needle slightly.





## INTRODUCTION

Your TRX 2.5R Racing Engine is broken in, the fuel mixture is balanced, and the idle is set...now it's time to have some fun! This section contains instructions on forward/reverse shifting, and making adjustments to your Revo. Before you go on, here are some important precautions to keep in mind.

- ⊕ **Don't run your Revo in water, mud, snow, or wet grass.** It's tempting, but water and mud are easily drawn through the air filter and will severely damage the engine. Small amounts of moisture can cause electronics to fail and loss of control over your Revo.
- ⊕ The TRX 2.5R Racing Engine is extremely powerful. Remember to apply the throttle gradually to prevent wheelies or loss of control.
- ⊕ Don't hold Revo off the ground and rev the engine excessively with no load on the engine. This practice could result in internal engine damage. Avoid over revving the engine when Revo is airborne after a jump.
- ⊕ Avoid excessive high-speed running for extended periods of time or over long distances. This could cause the engine to build up enough speed to exceed maximum safe RPM limits.
- ⊕ Don't drive your Revo with drive train damage of any kind. The engine could be damaged due to overloads caused by drivetrain friction, or over-revving caused by loose or missing parts.
- ⊕ Don't tow anything with your Revo. The engine is cooled by airflow created by speed. Towing creates a high load on the engine, and at the same time limits cooling of the engine due to low vehicle speed.
- ⊕ If your Revo gets stuck, stop driving immediately. Move the vehicle and then continue driving.
- ⊕ Never turn off the radio system while the engine is running. The truck could run out of control.

## Forward and Reverse Operation

Forward and reverse gears are selected with the shift button located in the transmitter handle grip. The switch is normally in the down, or forward, position.

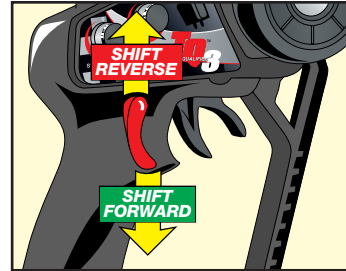

- ⊕ To shift into reverse, bring your Revo to a **complete stop** and push the shift button up. Accelerate to engage the gear.
- ⊕ To return to forward gear, repeat the same procedure and move the shift button down.
- ⊕ Revo will not shift between forward and reverse unless the truck is stopped. If it will not shift, then refer to the troubleshooting section on [www.Traxxas.com](http://www.Traxxas.com) or call Traxxas support.

## Driving Tips

- ⊕ Monster trucks by design have a high center of gravity that requires a different driving technique. To prevent rollovers, slow down as you approach turns and then apply moderate throttle through the turns. This technique will help Revo grab the surface and turn sharper.
- ⊕ Do not apply brakes and turn the wheel at the same time. You could tip the truck over.
- ⊕ When jumping, apply some throttle while Revo is in the air to keep the truck's nose up and land level on all 4 wheels. Be careful not to over-rev the engine or land at full throttle. Either could seriously damage your Revo. If the nose of the truck is too high, then quickly tap the brake to level the truck in the air.
- ⊕ Drive over large obstacles (such as curbs and rocks) at an angle, instead of head on. This will allow the suspension to articulate and absorb the impact much easier.
- ⊕ Even though Revo is capable of high speed in reverse, it is very difficult to control while driving in reverse. Limit your reverse speed to prevent crashing or flipping your Revo.
- ⊕ Change or clean your air filter element after each hour of running. This is critical for the life of your engine. Running time includes the engine break-in period.

## BASIC TUNING ADJUSTMENTS

This tuning and setup guide is separated into two sections- Basic and Advanced. Revo does not require any specialized knowledge or understanding of its unique suspension and drive train to perform typical, everyday setup and track tuning adjustments. Adjustment procedures for alignment, spring rate, damping, steering, and ride height are covered in the basic tuning section. Adjustments for the gear ratio, 2-speed shift point, slipper clutch, and brake are also covered. In most cases, the basic information is all that is needed to tune Revo to perform well on a variety of surfaces.

Revo was engineered to provide sophisticated additional tuning options well beyond the basics that allow expert users to extract the maximum performance from the truck. The advanced tuning section (beginning on page 42) covers topics such as optional suspension rockers, roll center adjustment, caster adjustment, bump steer tuning, differential setup, and fine tuning the 2-speed gear ratios. Make sure you fully understand the basic adjustments before experimenting with the advanced adjustments. Improper combinations of adjustments can adversely affect the performance of the truck, resulting in poor handling. If you don't know why you are changing an adjustment then you should leave it at its factory setting. Also included are instructions for using the Long-Travel rockers and springs supplied with Revo. The long travel rockers allow extreme suspension travel for rock crawling and rough, large-scale terrain. The long travel rockers allow the suspension to operate at its extreme mechanical limits and is recommended for advanced users.

### SUSPENSION TUNING

#### Springs

The front and rear springs on Revo have different spring rates. The rear springs are about 20% stiffer than the front springs. The spring's pre-load tension can be adjusted by turning the spring pre-load adjuster. Adjusting the pre-load changes the suspension sag. Suspension sag basically defines how much the suspension compresses when the truck is at rest. Adjust the pre-load so that the suspension compresses about one third of its full suspension travel (see illustration). If suspension sag is severe and requires a large increase of the spring pre-load to compensate, then a firmer spring should be used. Firmer springs (supplied) must be used when the Long Travel rocker arms are installed.

Use a stiffer spring to reduce sag, reduce body lean, control brake dive, and provide a firmer, more responsive overall feel. If Revo is lightened significantly for racing applications, softer springs will be necessary to

allow the suspension to sag properly. Heavier configurations will require stiffer springs. Ride height is adjusted by changing the length or position of the pushrods in the lower suspension arms. See the next section for ride height adjustments. The suspension sag and spring pre-load should be readjusted anytime the springs are removed and/or replaced.

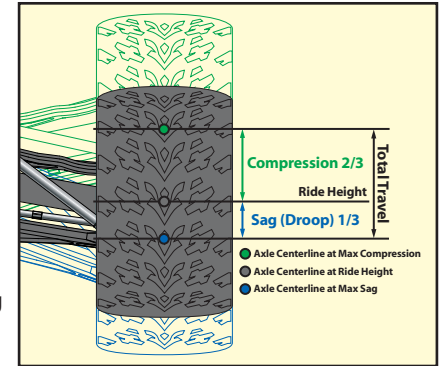

Optional springs available from Traxxas are listed below. Refer to your parts list for a complete part number listing. Higher rate springs are stiffer. Springs can be identified by dots of color on one end.

#### 90mm Travel

Dot Color	Spring Rate
● Yellow	14.8 lb/in (2.6 N/mm)
○ White	16.6 lb/in (2.9 N/mm) (Standard Front)
● Orange	18.3 lb/in (3.2 N/mm)
● Green	20.0 lb/in (3.5 N/mm) (Standard Rear)
● Gold	21.7 lb/in (3.8 N/mm)
● Tan	23.4 lb/in (4.1 N/mm)
● Black	25.1 lb/in (4.4 N/mm)

#### 120mm Long Travel

Dot Color	Spring Rate
○ Silver	28.0 lb/in (4.9 N/mm) (Standard Front)
● Pink	30.8 lb/in (5.4 N/mm)
● Blue	33.7 lb/in (5.9 N/mm) (Standard Rear)
● Purple	36.5 lb/in (6.4 N/mm)

**Note:** 90mm Travel springs are not recommended for use with the Long Travel Rockers.

#### Ride Height Adjustment

The rocker arm suspension uses push rods on each suspension arm. Changing the length and/or position of the push rod adjusts the ride height without affecting or compromising other suspension parameters. For example, you can raise and lower the ride height without changing up/down travel distribution, changing springs, or affecting your progressive rate. This feature is unique to Revo and is extremely beneficial in a racing environment where you can achieve a low center of gravity (by lowering the ride height) without losing any suspension capability. Increasing the ride height will increase ground clearance for rough terrain.

The ride height of the model can be changed by mounting the push rod in a different hole in the lower suspension arm. From the factory, the push rod comes installed in the center hole of the lower suspension arm's push rod mount. If the push rod is mounted in the inner hole, the ride height of the vehicle increases. If mounted in the outer hole, the ride height decreases.

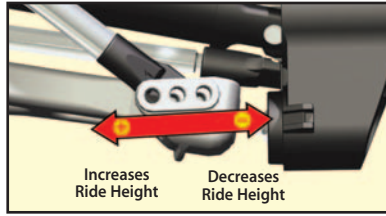

The ride height can be finely tuned by adjusting the sag of the suspension. **Do not attempt to make large changes to the ride height by adjusting the spring pre-load on the shock bodies.** If suspension sag is severe and requires a large increase of the spring pre-load to compensate, then a firmer spring should be used. The lowest ride height can be achieved by installing the optional adjustable push rod in the outermost hole of the lower suspension arm's push rod mount. Turn the rod ends all the way in until they stop (shortening the length).

The optional Long Travel rocker arms are designed to be used only with the standard non-adjustable push rods installed in the hole labeled "LT" (the middle hole of the lower suspension arm's push rod mount). Any minor adjustments to the ride height are accomplished by adjusting the spring pre-load.

### Adjusting the Pivot Ball Caps

The pivot ball caps should be adjusted so that the pivot balls operate freely in the axle carriers with no excess play. Use the provided four-way suspension multi-tool to tighten or loosen the pivot ball cap.

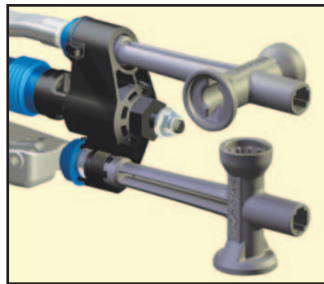

### Shock Oil

The 4 oil-filled aluminum shocks (dampers) effectively control the suspension movement by preventing the wheels and tires from continuing to "bounce" after rebounding from a bump. Changing the oil in the shocks can vary the suspension damping effect. Changing the oil to a higher viscosity oil will increase damping. Lowering the viscosity of the oil will cause the suspension damping to be reduced. Damping should be increased (with higher viscosity oil) if the model is bottoming easily over jumps. Damping should be decreased (with thinner viscosity oil) if the

model is hopping over small bumps and feels unstable. The viscosity of shock oil is affected by extremes in operating temperature; an oil of certain viscosity will become less viscous at higher temperatures and more viscous at lower temperatures. Operating in regions with cold temperatures may require lower viscosity oil. From the factory, the shocks are filled with SAE-30W silicone oil. Only use 100% silicone oil in the shock.

For shock piston tuning see *Advanced Tuning Adjustments* on page 44.

### Replacing Shock Oil

The shocks have to be removed from the vehicle and disassembled to change the oil.

1. Remove the lower spring retainer and shock spring.
2. Remove the upper shock cap using the shock wrench and the suspension multi tool
3. Empty the used shock oil from the shock body.
4. Fill the shock with new silicone shock oil up to the top of the shock body.
5. Slowly move the piston up and down (always keeping it submerged in oil) to release the air bubbles. Let the shock sit for a few minutes to allow any remaining air bubbles to surface.
6. Slowly thread the upper cap with the installed shock bladder onto the shock body with the suspension multi tool. The excess oil will bleed out of the small hole in the shock cap.
7. Tighten the shock cap until snug. Use the included steel shock wrench to hold onto shock body while tightening.



**Important:** The shocks are assembled at the factory with a center-to-center distance (between the rod end balls) of 87mm. Any time the shocks are removed and disassembled, this distance should be checked to ensure proper operation of the suspension.



For caster, roll center, and optional rocker arm tuning see *Advanced Tuning Adjustments* on page 42.

A camber gauge (available at your local hobby shop) can be a useful tool for alignment setting.

All of the toe links are installed on the truck so that the left hand thread indicators point to the same direction. This makes it easier to remember which way to turn the wrench to increase or decrease toe link length (the direction is same at all four corners). Note that the groove in the hex indicates the side of the toe link with the left-hand threads.

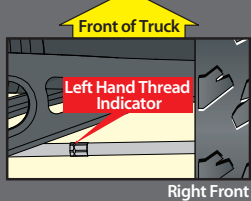
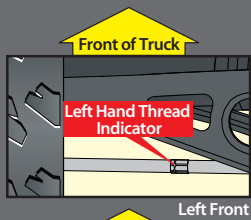

### ALIGNMENT SETTINGS

The alignment settings are critical for optimizing the performance of Revo. Adjust your alignment as carefully and precisely as you possibly can.

#### Toe Adjustment

The wheels can be adjusted to point straight ahead or have a toe-in or toe-out setting. To help you remember, look down at your feet. For toe-in, your feet point towards each other. For toe-out, your feet point away from each other.

The toe angle of the front wheels can be adjusted by varying the length of the toe links that connect the steering linkage to the front axle carriers. The toe angle of the rear wheels can be adjusted by varying the length of the metal toe links that connect the rear bulkheads to the rear axle carriers. The front toe links and rear toe links are equipped with turnbuckles. The lengths of the toe links can be adjusted by turning them with the included 5mm Traxxas wrench.

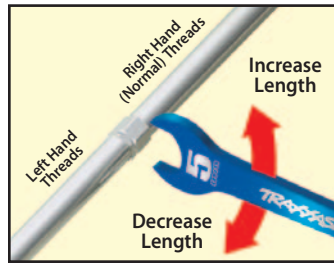
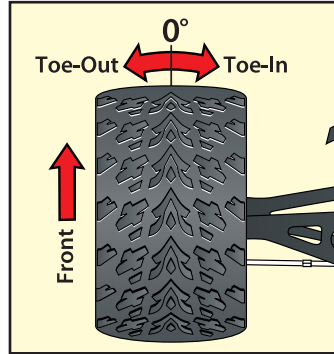

#### Toe Base Factory Settings

**Front:** 0-degrees  
**Rear:** 1-degree toe-in each side

Under certain conditions, toe-in can be increased to a maximum of 3 degrees. To avoid potential interference of suspension components with the long travel rockers installed, see the maximum alignment limits table on page 37.

#### Static Camber Adjustment

The wheels can be set to have either positive or negative camber (see illustration below). The camber angle changes as the wheel moves up and down through its range of travel. Static camber is the camber angle at the wheel when the vehicle is set at its normal, stationary ride height.

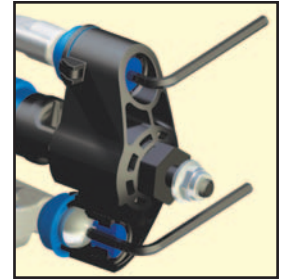

The suspension pivot balls located in the axle carriers adjust the static camber. The pivot balls are protected by blue dust plugs. To adjust your static camber, insert the supplied 2.5 mm hex wrench through the slit in the dust plug and engage the end of the pivot ball (compressing the suspension until the arms are parallel to the ground will allow for easier hex wrench engagement). The upper pivot ball is normally screwed all the way in. Negative camber is achieved by screwing the pivot ball of the lower control arm out. **Note:** When camber is changed, the toe angle of the wheel has to be reset.

#### Static Camber Base Factory Settings

**Front:** 1-degree negative camber each side  
**Rear:** 1-degree negative camber each side

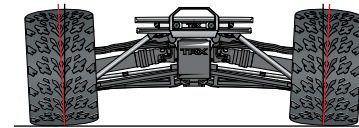

Positive camber

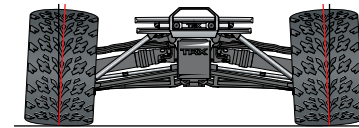

Negative camber

**Maximum Alignment Limits (using stock push rod length)**

Revo's maximum toe and camber alignment settings can be limited by the ride height setting. Do not exceed the maximum limits or you could experience interference between suspension components. The ride height is controlled by where the push rod is installed in the lower suspension arm. First determine which of the following configurations you are using:

- a. **Stock Configuration** – When the pushrod is in the middle position of the lower control arm.
- b. **Raised Configuration** - When the pushrod is in the raised position to increase the vehicle's ride height (innermost hole in lower control arm).
- c. **Lowered Configuration** - When the pushrod is in the lowered position to decrease the vehicle's ride height (outermost hole in lower control arm).
- d. **Long Travel Configuration** – When the pushrod is in the middle position of the lower control arm with the Long Travel rockers installed.

**Front Suspension**

The following are suggested maximum settings for the front suspension in order to avoid interference between suspension components:

Configuration	Available Camber (degrees)	Available Toe (degrees)	
		Toe In	Toe Out
Stock	+3 to -5	3	3
Raised	+3 to -1	1	1
Lowered	+3 to -5	3	3
Long travel	+3 to -1	1	1

**Rear Suspension**

The following are suggested maximum settings for the rear suspension for all configurations. Toe out is not normally used on the rear of Revo.

Configuration	Available Camber (degrees)	Available Toe (degrees)	
		Toe In	Toe Out
All	+3 to -5	3	2

**TRANSMISSION TUNING**

**Adjusting the Slipper Clutch**

Your Revo is equipped with an adjustable Torque Control slipper clutch. The slipper clutch is integrated into the main spur gear on the transmission (see page 6). The slipper clutch is adjusted by loosening the spring-loaded locknut on the slipper shaft. Use the supplied 8mm open-end metric wrench. To tighten or loosen the slipper nut, insert the 2.0mm hex wrench into the hole in the end of the slipper shaft. This locks the shaft for adjustments. Turn the adjustment nut clockwise to tighten (less slippage) and counter-clockwise to loosen (more slippage). The slipper clutch has two functions:



1. Limiting the engine's torque output to the wheels to prevent wheelspin on low traction surfaces and uncontrolled wheelies on high traction surfaces.
2. Protecting the drivetrain from sudden impact or shock loads (such as landing from a jump with the engine at full throttle).

From the factory the slipper clutch is set for minimal slippage, just enough to protect the drivetrain from shock loads. On slippery, low traction surfaces such as a hard-packed, dry racetrack you may benefit from loosening the slipper adjustment nut to allow for more clutch slippage. This will make the truck easier and more forgiving to drive by helping to reduce the amount of wheel spin. Loosening the slipper adjustment can also improve performance on extreme high traction surfaces by preventing the front end from lifting off of the ground when accelerating. Make slipper adjustments in small 1/8 turn increments.

The maximum tight setting for the slipper is just at the point where there is little or no tire slippage on a high traction surface such as carpet or a prepared racetrack. The slipper should not be tightened to the point that clutch slippage is completely eliminated. Do not overtighten the slipper nut or you could damage the slipper bearings, pressure plates, or other components.

**i** Two Speed Adjustment note: If the truck will not roll forward while the spur gear is held, the transmission may still be in reverse gear.

➔ For adjusting two-speed and gear ratios see *Advanced Tuning Adjustments* on page 44.

### Adjusting the Two-Speed Transmission

Revo comes equipped with an adjustable two-speed transmission. When the shift point on the transmission is adjusted correctly, it will maximize acceleration and improve drivability. Use a 2mm hex wrench to adjust the shift point. To make the adjustment, the engine must be off (not running).

1. Shift the transmission into forward gear (shift button down).
2. Remove the rubber access plug from the top of the transmission housing.
3. While looking through the opening, rotate the spur gear to align the cutout (notch) on the internal 2-speed clutch drum with the opening.
4. Hold the spur gear and slowly roll the truck forward until the hex on the black adjustment set screw becomes visible in the opening. **Note:** the truck will only roll forward (not backwards) when the spur gear is held stationary.
5. Insert the 2.0mm hex wrench through the clutch drum and into the adjustment screw.
6. Turn the adjustment screw 1/8 turn counter clockwise to lower the shift point (shifts sooner). Be careful not to loosen the adjustment screw too much or you may cause the screw and spring to fall out (requiring major disassembly and repair). Turn the adjustment screw clockwise for later shifts.
7. Reinstall the rubber access plug to prevent dirt from entering the transmission. Do not put oil or other lubricants into the transmission through the two-speed adjustment access.
8. Check performance by running a test lap after each adjustment. On a small race track with many tight turns, try setting the shift point later so that the truck only shifts into second gear on the main straightaway. This will prevent an unexpected shift in the middle of a turn. On larger tracks it may be necessary to allow earlier shifts for increased speed.

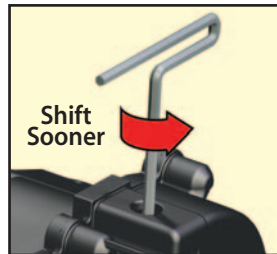
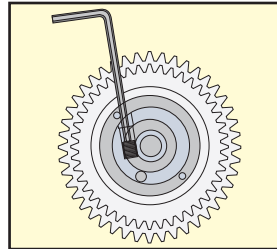
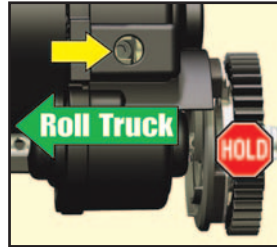

### Adjusting the Spur Gear/Clutch Bell Gear Mesh

The ideal spur gear/clutch bell gear mesh for Revo is 0.1 mm. To set the gear mesh, place a strip of standard letter/A4 size copy or printer paper (about 0.1mm thick) between the mating teeth. Loosen the two horizontal engine mount screws and slide the engine mount up to push the clutch bell gear against the spur gear so that the paper is not too tight to pull out or too loose that it will fall out. Tighten the two horizontal engine mount screws securely. When the paper is removed, you should feel only the slightest amount of play between the gears (almost none) and there should be no binding or friction.



### Changing the Spur Gear

1. Remove the four cap head screws that secure the engine to the engine mount.
2. Remove the button head screw that secures the pipe hanger to the rear body mount (see inset).
3. Carefully remove the engine and exhaust system from the spur gear area to allow enough room to remove the spur gear.
4. Remove the three screws on the slipper clutch assembly using a 2.5mm hex wrench. Slide the spur gear off of the slipper shaft. If the spur gear is too tight on the shaft, gently pry on the back of the gear with a flat screw driver to loosen it.

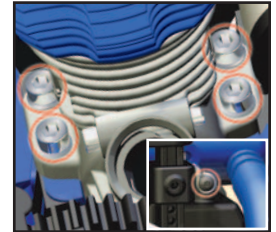

Repeat the above steps in reverse order to install the new spur gear.

### DUAL SERVO STEERING SYSTEM

Revo uses dual-servo steering and a single heavy-duty servo saver for powerful, responsive steering. To prevent unnecessary receiver battery drain it is important to make sure that the servos are "at rest" when the steering is at neutral. If one servo is out of adjustment, then both servos will work against each other, fighting to find center.

### Adjusting The Steering System

1. Remove the servo horns and steering links from the servos. Disconnect the steering links from the servo saver.

2. Adjust both the steering links to be the exact same length (31.7mm - use "Steering Servo Horn Link Length Template" on page 39 to set length).
3. Switch on the power to the receiver and the transmitter.
4. Adjust the steering trim on the transmitter to the neutral "0" position.
5. Connect one end of a steering link to the steering servo saver arm and the other end to the servo horn
6. Position the steering servo saver arm perpendicular to the centerline of the vehicle.
7. While holding the steering servo saver arm in the position mentioned in step 6, install the servo horn onto the servo such that the steering link is parallel with the centerline of the vehicle. This will automatically set the servo horn at the 7-degree offset shown in the illustration.
8. Install the second servo horn on the other side following the same procedure.



If necessary, fine-tune the length of the second steering link to eliminate any load on the steering system in the neutral position.

If you are using aftermarket servos, it is important to use servo horns designed for Revo. Optional steering servo horns are sold separately for use with non-Traxxas servos.

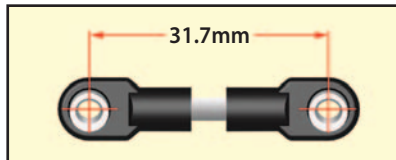

Steering Link Length Template

### Servo Saver Tuning

An optional stiffer spring is available for the servo saver when using servos with metal gear sets (see parts list for details). Do not use this spring with standard Traxxas high-torque servos.

## BRAKE SETUP & ADJUSTMENT

Revo is equipped with a disc brake that rides on the yoke of the transmission's front output shaft. The brake is preset at the factory and should not require attention. As the brake material wears, future adjustments may be necessary.

### Brake Shoulder Screw Adjustment

The two shoulder bolts that are used to secure the brake pads to the transmission housing may need to be adjusted periodically as the brake

material wears down. They should be tightened so a 0.50mm (.020") gap exists between the disk and the brake pad (on the transmission side). Adjust in one of the following ways:

1. Use a .50mm feeler gauge between the brake pad insert and brake disk.
2. Push the outer brake pad firmly against the inner pad with your finger, sandwiching the brake disk between the brake calipers. Tighten the brake shoulder bolts until they just barely touch the brake pads. Do not over tighten these fasteners or you could damage the brake calipers. Loosen each of the shoulder bolts by 1 turn.



### Brake Linkage Adjustment

When correctly adjusted, the brake linkage spring should barely touch the rod guide when the servo is in neutral position (closed throttle). This will ensure no brake drag during operation of the vehicle. The brake adjustment knob can be threaded away from the spring for less braking power if desired. Do not adjust knob to apply pressure against the spring while the servo is in the neutral position. This will induce brake drag and cause undesirable handling.

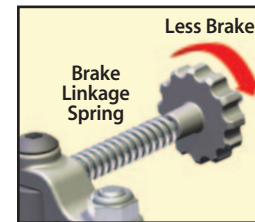

The position of the z-bend from the factory is in the middle position of the servo horn. Changing this position will affect the way the brake force is applied.

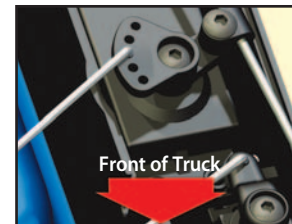

The brake adjustment knob will need to be readjusted if this position is changed.

### Brake Pad Wear and Replacement

During normal use the brake pads should wear at a relatively slow rate. However, if the brake pads wear down close to the metal pad holders, they should be replaced. Any more wear than this could cause damage to the brake parts and improper operation of the brake system.



If the engine is worn or damaged enough to require replacing the piston, sleeve, or connecting rod, consider exchanging your old engine for a brand new engine under the terms of the Traxxas Lifetime Engine Replacement Plan (ERP). It could save you time and effort. Details are in your model's documentation package.



The TRX 2.5R Racing Engine is designed to be easy to rebuild. Critical engine components such as the crankcase, crankshaft, and engine bearings are made to extremely high quality standards and should under normal circumstances outlast multiple sets of pistons, sleeves, connecting rods, and wrist pins (reciprocating assemblies). It could be more economical for you to continue to use your good bearings and crankshafts, and simply replace the reciprocating assembly as needed. Engine assembly is not difficult and replacing the reciprocating assembly does not require any special tools or skills.

Your Revo requires timely maintenance in order to stay in top running condition. **Neglecting the maintenance could allow dirt, deposits, and moisture to build up inside the engine leading to internal engine failure.** The following procedures should be taken very seriously.

### After each hour of running:

- ☉ Clean and re-oil the air filter. The instructions for this procedure are on page 23. **We cannot stress enough the value of cleaning your air filter at the scheduled intervals.** The cleanliness and condition of your air filter directly influences the running life span of your engine. **Do not skip air filter maintenance!**
- ☉ Clean the outside of the engine of accumulated dirt, oil, and grime. Accumulated grime will decrease the engine's ability to cool itself.

### After each running session:

- ☉ Perform after-run maintenance on the engine. This clears the engine of destructive moisture and other corrosive deposits. **This is extremely important for the life of the engine.** See page 41 for after-run maintenance procedures.
- ☉ Inspect the gears for wear, broken teeth, or debris lodged between the teeth
- ☉ Inspect the vehicle for obvious damage or wear. Look for:
  1. Loose or missing screws
  2. Cracked, bent, or damaged parts
  3. Cut or loose wiring
  4. Cut or kinked fuel lines
  5. Signs of fuel leakage

### Other periodic maintenance:

- ☉ **Connecting rod:** The connecting rod should be replaced when the piston and sleeve are replaced. Also replace the piston wrist pin and G-clip whenever the connecting rod is replaced. As with other internal engine components, connecting rod life depends engine's usage and the quality and frequency of the engine maintenance. Inspect the connecting rod after 3-gallons of fuel have been used.

- ☉ **Slipper clutch pads** (friction material): Under normal use, the friction material in the slipper clutch should wear very slowly. If the thickness of any one of the slipper clutch pads is 1.8mm or less, the friction disc should be replaced.

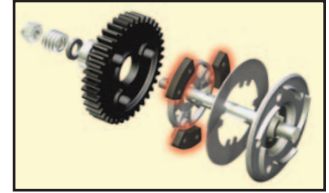

Measure the pad thickness using calipers or measuring against the diameter of the 1.5 and 2.0mm hex wrenches provided with the model.

- ☉ **Piston/sleeve:** The life of the piston and sleeve will vary greatly with how the engine was used and maintained. The piston and sleeve should be replaced when they no longer seal effectively (loss of compression). Symptoms include the engine being difficult to start when warm, stalling when warm, and stalling when throttle is suddenly closed to idle. Replace the wrist pin and G-clip whenever the piston and sleeve are replaced.

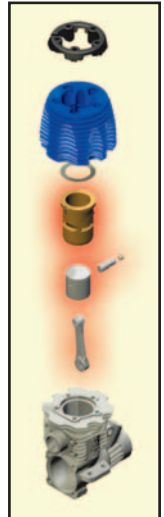



### After-run Procedure

You must perform after-run maintenance on your Traxxas engine whenever the model will be stored for longer than a few hours. Taking the time to prepare your engine for storage will reward you with longer engine life, easier starting, and better performance.

When a nitro engine is shut off, some excess unburned fuel remains in the engine. The methanol in model engine fuel is hygroscopic, which means it easily attracts and absorbs moisture. This moisture can cause rust and corrosion on the steel engine parts (crankshaft, bearings, wrist pin and starter shaft) if the fuel is not removed from the engine. There are after run oil products available from your hobby dealer or you can use WD-40™, a common household lubricant. To ensure your TRX 2.5R Racing Engine is protected from internal corrosion, use the following procedure:

1. Whenever possible, shut off the engine by pinching the fuel line closed. This allows most of the excess fuel to be consumed by the engine. Be sure the throttle is in the idle position. You may have to pinch the fuel line closed for several seconds before the engine stops.
2. Completely empty the fuel tank. Use your fuel-dispensing bottle to suck out the old fuel. Do not mix the old fuel with your fresh fuel supply. If you leave fuel in the tank, transporting or handling your Revo may cause fuel to run into the engine.
3. With the fuel tank empty and the throttle at the idle position, try to start the engine. The engine will most likely start and run for a few seconds as it uses up any fuel remaining in the engine and fuel lines.
4. Once the engine stops, clean the outside of the engine with compressed air or spray motor cleaner. Once the engine is clean and dry, remove the glow plug power wire, glow plug, and air filter.
5. Open the throttle fully and spray a one-second burst of WD-40 into the carburetor and into the glow plug hole (Caution! Wear safety glasses to prevent spray from getting into your eyes). If you are using after-run oil, follow the manufacturer's instructions.
6. Place a rag or paper towel over the engine to catch any WD-40 or after-run oil that may come out the carburetor or glow plug hole.
7. Connect the EZ-Start controller to the model and spin the engine for 10 seconds.
8. Remove the rag or paper towel and repeat steps 5–7 two more times.
9. Clean and re-oil the air filter so it will be ready for use next time. See page 23 for air filter maintenance instructions.
10. Replace the glow plug, reconnect the glow plug power wire, and reinstall the air filter.



Denatured alcohol (available from home centers and paint supply stores) in a spray bottle is an extremely effective cleaner. Be sure to wear safety glasses and gloves when working with denatured alcohol.



Be sure to follow proper maintenance and storage procedures to avoid damage to your engine and other components of your Revo.



Don't put the fuel from your tank back into your fuel jug. Dispose of it properly, following city or county regulations.



Always wear eye protection when using compressed air or spray cleaners and lubricants.

## ADVANCED TUNING ADJUSTMENTS

This advanced tuning guide will take you one step further into the cutting edge technology that has been designed into Revo. Follow the instructions provided here to take advantage of Revo's maximum performance potential.

### SUSPENSION AND ALIGNMENT SETTINGS

#### Caster Adjustment

The caster angle of the front suspension may be used to adjust the understeer (push)/oversteer handling characteristics of the model. Generally, increasing the caster angle will move the truck towards an oversteer condition (more traction on the front tires, less on the rear tires). Decreasing the caster angle will create a tendency towards understeer (pushing in the turns). From the factory, the front suspension is set to a caster angle of 10-degrees. The rear caster angle is not adjustable. The caster angle of the front suspension can be adjusted from 5° to 15°. Adjust the caster by positioning the caster adjustment shims on the upper control arms of the front suspension as shown in the table below:

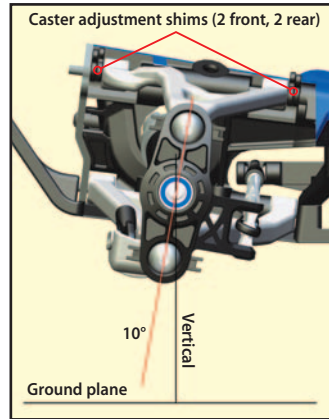

Number and Position of Caster Adjustment Shims (Front Upper Control Arm)

Caster	In Front of Hinge Pin Boss	Behind Hinge Pin Boss
5.0°	None	Four
7.5°	One	Three
10.0°	Two	Two
12.5°	Three	One
15.0°	Four	None

#### Caster Angle, and Bump Steer

Bump steer is unwanted change in the steering angle of the front wheels as the suspension travels up and down. It can result in unstable and unpredictable handling. Bump steer is affected by the position of the outer toe link end on the axle carrier. From the factory, the toe links are positioned so that bump steer is virtually eliminated (about 3/100 of a degree through the entire range of travel). When the caster angle is changed, the outer toe link end should be repositioned on the axle carrier to maintain zero bump steer geometry. Adjustment is achieved using the shims and hollow balls provided with the vehicle. Refer to the Bump Steer Elimination chart on

page 43, and look up your caster angle setting to find the correct position for the outer toe links. Positioning the toe-links correctly will maintain the original factory geometry and eliminate the unwanted steering angle changes caused by bump steer.

#### Roll Center

There are two holes on the bulkheads to mount each upper suspension arm. The roll center of the vehicle can be raised by mounting the upper control arm in the lower of the two holes. This will effectively increase the roll stiffness of the vehicle (similar to installing swaybars). Adding roll resistance to one end of the vehicle will tend to add traction to the opposite end. For example, increasing roll resistance in the rear by installing the upper arms in the lower holes will provide more traction for the front wheels and potentially more steering. Installing the upper arms in the lower holes on the front and rear will increase overall roll resistance without changing the handling balance. The arms are installed in the upper position from the factory to make the truck easier and more forgiving to drive and less likely to traction roll in turns. The lower holes should be reserved for track tuning. **Note:** When the upper suspension arms are moved to the lower holes, the front outer toe link ends and the rear toe control links should be repositioned to eliminate bump steer. Refer to the Bump Steer Elimination chart on page 43, and look up your suspension combination (caster angle and roll center position) to find the correct position for the front outer toe links and the rear toe control links. Adjustment is achieved using the shims and hollow balls provided with the vehicle.

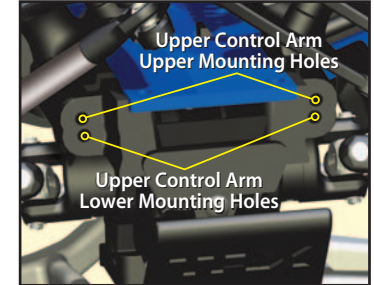

#### Rockers (Progressive Rate/ Suspension Travel)

One of the most exciting aspects of Revo's suspension is the inboard shock (damper) arrangement that uses pivoting rockers to translate vertical wheel travel into linear shock motion. The rockers can be changed to increase or decrease the maximum wheel travel and also to change the progressive rate of the suspension.

The progressive rate determines how much the force at the wheel produced by the springs being compressed (wheel force) will vary with suspension travel (or vertical travel of the wheel). On a progressive suspension arrangement, the wheel force will increase at a faster and faster rate as the suspension is compressed. It feels as though the shock spring gets progressively stiffer the more you compress the suspension. On a linear suspension arrangement, the wheel force increases linearly as the

suspension is compressed. The spring does not feel any stiffer, even when the suspension is fully compressed. This provides a very "plush" feeling suspension with seemingly bottomless suspension travel.

ROCKER ARM	TOTAL TRAVEL	PROGRESSIVE RATE
Progressive 1	90mm (60mm up/30mm down)	Low
Progressive 2	90mm (60mm up/30mm down)	Medium
Progressive 3	90mm (60mm up/30mm down)	High
Long Travel (included)	120mm (80mm up/40mm down)	Low

A total of four different rocker arm sets are available for Revo. All rocker arms except the Long Travel rocker arms will allow the wheel to travel a total of 90mm in the vertical direction. From the ride height position, the wheel will be able to travel 60mm in the upward direction (bump), and 30mm in the downward direction (droop). The Long Travel rocker arm increases total travel to 120mm. The progressive rate can be increased or decreased by installing different rocker arm sets. The rockers are labeled Progressive 1 to Progressive 3. Progressive 1 rockers will provide a low progressive rate that maintains consistent damping force across through the whole range of suspension travel. These are best for extremely rough terrain that requires maximum suspension articulation. Progressive 3 rockers use high progressive rate that will improve high-speed cornering on smooth surfaces by providing a firmer feel. Body roll, brake dive and rear squat will also be reduced. Always change all four rockers as a complete set. Do not mix rates and travel.

Using rockers with lower progressive rate may require the use of stiffer springs to maintain proper spring pre-load and ride height. The spring pre-load adjuster on each shock is designed for minor adjustments. If the adjuster needs to be turned all the way down (compressing the spring) in order to maintain proper ride height, then the next stiffer spring should be used.

The chart below demonstrate the effect of the various rocker arms on wheel force as the suspension is compressed. On the progressive rate, wheel force is light at first and increases as the suspension is compressed.

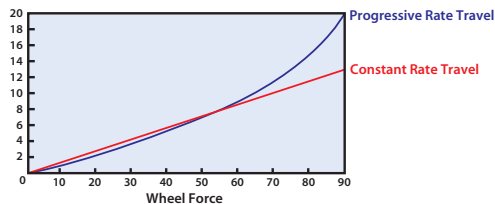

### Bump Steer Elimination Chart

The illustrations and the following table detail the position of the outer toe link end for various caster and roll center settings to eliminate bump steer. The shims and the hollow balls used to adjust bump steer are provided with your vehicle.

#### FRONT

Outer Toe Link End Setup	5°	7.5°	10°	12.5°	15°	Control Arm Mounting Hole on Front Bulkhead
Standard Hollow Ball					☉	Upper
Thin Shim						
Thick Shim				☉		Lower
Thin Shim				☉		Upper
Standard Hollow Ball						
Thick Shim			☉			Lower
Tall Center Hollow Ball			☉			Upper
Thin Shim						
Thick Shim			☉			Upper
Standard Hollow Ball						
Thin Shim	☉					Lower
Thick Shim	☉					Upper
Thin Shim						
Standard Hollow Ball						

#### REAR

When the rear upper control arms are mounted in the lower of its two mounting holes in the bulkhead (roll center), the tall hollow ball should be used as shown.



**!** When using Long Travel rockers, A correspondingly thicker shock oil (or pistons with smaller diameter bypass holes) should also be used to ensure a proper relationship between the spring and damping forces.

**Shock Piston Hole Sizes**

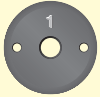

**Piston 1: 1.10 mm**



**Piston 2: 1.00 mm**

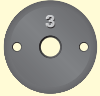

**Piston 3: 0.95 mm**



Never slide the threads on the shock rod past the X-ring seal when it is installed and compressed by the bottom cap of the shock. Doing so will damage the seal and cause shock oil to leak.

**SHOCK TUNING**

**Shock Pistons**

The shock pistons can be replaced with the available optional pistons to vary the amount of damping. Optional pistons with bypass holes that are larger or smaller (1, 2, or 3) than the factory installed stock pistons can be used to decrease or increase damping respectively. Change the pistons if you only have one weight of shock oil available to you. From the factory, Revo is equipped with #1 pistons in the front and #2 pistons in the rear.

**Shock disassembly**

The shocks must be removed from the vehicle and disassembled to change the pistons. Use the shock exploded views included with the model to aid in the assembly process.

1. Remove the spring and lower spring retainer from the shock.
2. Remove the shock cap (A) and empty the shock body of shock oil.
3. Remove the lower cap (B) and the x-ring from the shock body.
4. Use side cutters to grip the shock shaft just above the rod end (C). Remove the rod end from the shock shaft using the suspension multi tool (C).
5. Remove the shock shaft with piston from the shock body out through the top of the shock body.

**Shock assembly**

1. Replace the stock piston with desired optional piston. Be careful not to lose the small washer located below the piston.
2. Position the new piston onto the shock shaft above the small washer. Grip the threads of the shaft with side cutters or needlenose pliers and tighten the nut with the 4-way wrench to secure the assembly.

**Multi-tool Shock Functions**



**A. Tighten/Loosen Upper Cap**



**B. Tighten/Loosen Lower Cap**



**C. Remove/Install Rod End**



**Piston Installation/Removal**

3. Insert the shock shaft assembly through the shock body until the piston bottoms out.
4. Lubricate the shaft and x-ring with silicone oil.
5. Install the x-ring over the shaft and into the bore of the shock body.
6. Install the lower cap using the suspension multi tool (B).
7. Slide the bump stop onto the shaft.
8. Grip the shaft close to the threads with needle nose pliers or side cutters and thread the rod end onto the shock shaft until the rod end bottoms out (C).
9. Fill the shock with new silicone shock oil up to the top of the shock body. Slowly move the piston up and down (always keeping it submerged in oil) to release the air bubbles. Let the shock sit for a few minutes to allow any remaining air bubbles to surface.
10. Slowly thread the upper cap with the installed shock bladder onto the shock body with the suspension multi tool (A). The excess oil will bleed out of the small hole in the shock cap. Tighten the shock cap until snug. Use the included steel shock wrench to hold onto shock body while tightening.
11. Reinstall the spring and lower retainer.

**TRANSMISSION AND DIFFERENTIAL TUNING**

**Adjusting the Gear Ratio**

The gear ratio on Revo can be adjusted for different conditions that may require either increased acceleration or increased top speed. Adjusting the gear ratio is accomplished by changing the clutch bell on the engine and/or the spur gear (slipper clutch gear) on the transmission. From the factory, Revo is equipped with a 15-tooth clutch bell and a 38-tooth spur gear. This combination will provide a good balance of acceleration and top speed. Optional spur gears and clutch bell gears are listed on your parts list. Refer to the chart on page 45 for possible gearing combinations

**Adjusting the Two-Speed Ratios**

Revo is equipped to allow adjustment to the 2-speed by installing optional close and wide-ratio gearsets. This requires transmission removal and disassembly (see [www.Traxxas.com](http://www.Traxxas.com) for detailed instructions). The close ratio gearsets will reduce top speed slightly but will provide more powerful acceleration by reducing engine rpm loss when shifting from 1st gear to 2nd gear. The wide ratio gear set is designed for wide open areas and will increase top speed, but reduce acceleration due to greater RPM loss when shifting gears.

The following gear ratio chart shows the available combinations with optional spur gears, clutch bells, and two-speed gear sets.

With 14T Clutch Bell		# of Spur Gear Teeth		
2nd gear sets	Gear	36	38	40
17T/39T (Standard)	1st	24.21	25.55	26.9
	2nd	16.79	17.72	18.66
16T/40T (Close)	1st	24.21	25.55	26.9
	2nd	18.30	19.31	20.33
18T/38T (Wide)	1st	24.21	25.55	26.9
	2nd	15.45	16.31	17.17

With 15T Clutch Bell (Standard)		# of Spur Gear Teeth		
2nd gear sets	Gear	36	38	40
17T/39T (Standard)	1st	22.59	23.85*	25.1
	2nd	15.67	16.54*	17.41
16T/40T (Close)	1st	22.59	23.85	25.1
	2nd	17.08	18.03	18.97
18T/38T (Wide)	1st	22.59	23.85	25.1
	2nd	14.42	15.22	16.02

With 16T Clutch Bell		# of Spur Gear Teeth		
2nd gear sets	Gear	36	38	40
17T/39T (Standard)	1st	21.18	22.36	23.54
	2nd	14.69	15.51	16.32
16T/40T (Close)	1st	21.18	22.36	23.54
	2nd	16.01	16.9	17.79
18T/38T (Wide)	1st	21.18	22.36	23.54
	2nd	13.52	14.27	15.02

\*stock configuration out of the box

### Tuning The Sealed Gear Differentials

Revo's front and rear gear differentials allow the left and right wheels to spin at different speeds while turning so that the tires do not scuff or skid. This decreases the turning radius and increases steering performance.

The performance of the differentials can be tuned for different driving conditions and performance requirements. The differentials are filled with silicone differential fluid, and are sealed to maintain consistent long-term performance. Changing the oil in the differential with either lower or higher viscosity oil will vary the performance characteristics of the differentials.

Changing to a higher viscosity oil in the differential will reduce the tendency for engine power to be transferred to the wheel with the least traction. You may notice this when making sharp turns on slick surfaces. The unloaded wheels on the inside of the turn have the least traction and

tend to spin up to extremely high rpms. Higher viscosity (thicker) oil causes the differential to act like a limited-slip differential, distributing more equal power to the left and right wheels. Revo will generally benefit from higher viscosity oil when climbing, rock crawling, or racing on low traction surfaces. **Note:** Heavier oil will allow power to be transferred even with one or more tires off the ground. This can make the vehicle more likely to overturn.

From the factory, both the differentials are filled with SAE 30,000W viscosity silicone oil. Only use silicone oil in the differentials. Traxxas sells SAE 10,000W and SAE 50,000W viscosity oil (see your parts list). The differentials have to be removed from the vehicle and disassembled to change/replace oil.

### Installing the Long Travel Rockers

Use the exploded views included with the model to aid in the installation process. All of the rockers have labels identifying their proper location; RF (right front), LF (left front), RR (right rear), and LR (left rear). **Note:** The exhaust system must be removed to access the rear rocker arms.

#### 1. Remove shock absorbers

Remove the screws that secure the shocks to the chassis shock mounts, and to the rocker arms.

#### 2. Install long travel shock springs

Replace all four of the 90mm travel shock springs with the four 120mm long travel shock springs. The front shock springs are indicated by a silver dot, and the rear shock springs are indicated by a blue dot.

#### 3. Install long travel rockers

Replace the 90mm travel rockers with the long travel rockers by removing the four 4x6 buttonhead cap screws from the rocker pivot posts. Remove the 5x11 ball bearings from the rockers. Install the same 5x11 ball bearings in the long travel rockers. Secure the long travel rockers to the pivots with the same 4x6 buttonhead cap screws.

#### 4. Locate push rods

Make sure that all four of the suspension push rods are located and secured into the middle position (marked LT) on the lower suspension arms.

#### 5. Reinstall shock absorbers

Reinstall all four shock absorbers back into their respective locations.

Use higher viscosity (thicker) oil for:

- More power to the wheels with the most traction.
- Racing on low-traction smooth surfaces.
- Better performance for climbing on uneven terrain.

Using lower viscosity (thinner) oil for:

- More power to the wheels with least traction.
- Racing on low-traction rough surfaces.

- .15, 20
- ABC, 20
- After-run maintenance, 18
- After-run Procedure, 41
- Air density, 31
- Air filter, 6, 19, 20, 23, 33
  - foam, 20
  - maintenance, 18, 23
  - oil, 5, 23
- Air intake, 19
- Air temperature, 32
- Air/fuel mixture, 24, 25
- Air/fuel ratio, 24, 25
- Airflow, 32, 33
- Alignment, 36
  - bump steer, 42, 43
  - caster, 42
  - caster angle, 42
  - configurations, 37
  - maximum limits, 37
  - negative camber, 36
  - positive camber, 36
  - roll center, 42
  - settings, 36
  - static camber, 36
  - toe, 36
- Altitude, 31
- Ambient temperature, 32
- Antenna (receiver), 7, 9, 13
  - mount, 6
- Antenna (transmitter), 9, 17
- Atmospheric conditions, 18, 24, 32
- Axle carrier, 6
- Axle pins, 8
- Barometric pressure, 31
- Baseline setting, 31
- Batteries, 11, 16
  - alkaline, 5
  - care, 12
  - charging, 11, 12, 26
  - compartment, 9, 11
- EZ-Start, 26
- mAh, 10
- NiCad (nickel-cadmium), 5, 10, 11
- NiMH (nickel-metal hydride), 10, 11
  - receiver, 12
  - RX pack (5-cell pack), 5, 9, 10, 11
  - transmitter, 11
- Big block .15, 20
- Body mount, 6
- Brake, 6
  - adjustment, 39
  - linkage adjustment, 39
  - pad wear and replacement, 39
  - shoulder screw adjustment, 39
  - tension adjuster, 6
- Bulkhead, 6
- Bumper, 6
- Bumper Mount, 6
- CA glue, 5, 8
- Carburetor (carb), 19, 20, 24
  - adjustments, 24
  - fine-tuning, 31
  - slide, 21
  - venturi, 24
- Channel, 9, 10, 16
- Channel number, 10
- Charger, 5, see also Batteries; charging
- Charging jack, 6, 12, see also Batteries; charging
- Batteries; charging
- Chassis, 6
- Clean-out, 20
- Clearing your frequency, 10
- Clutch bell, 19, 45
  - mesh, 38
- Combustion chamber, 20, 27
- Compression, 21
- Connecting rod, 20
  - maintenance, 40
- Cooling fins, 20
- Crankcase, 19, 20
- Crankshaft, 19, 20
- Crashing, 33
- Crystal (X-tal), 10, 16
- Customer service, 3
- Cylinder sealing, 28
- Shocks (damper), 6
  - center-to-center distance, 35
  - shock oil, 35
  - pistons, 44
  - pre-load adjuster, 6
  - replacing oil, 35
- Decals, 8
- Differential, 6
  - oil, 45
  - tuning, 45
- Drivetrain friction, 33
- Driving, 33
  - tips, 33
- Dyno, 20
- E-mail, 3
- Engine, TRX 2.5R, 18
  - "cutting out", 30
  - "sluggish", 21, 29, 30
  - break-in, 18, 20, 21, 22, 28
    - tank 1, 29
    - tank 2, 29
    - tank 3, 29
    - tank 4, 29
    - tank 5, 29
    - tank 6, 29
    - winter break in, 32
  - clearing a flood, 27
  - damage, 23
  - detonation, 30
  - failure, 23
  - hesitation, 30
  - high altitude operation, 29
  - overheating, 21, 30
  - priming, 21, 28
  - revving, 33
  - shut-off clamp, 6, 19, 27, 31
  - shutting off, 27, 29
  - stalling, 21, 28, 30
  - starting, 26, 27, 28
  - temperature, 28, 30, 32
    - cooling, 32
  - terms, 20
  - tuning, 24, 25, 30, 31
    - by temperature, 32
- Exhaust, 19, 20, 28
- EZ-Start, 19, 20, 26
  - controller, 19
  - cush drive, 26
  - drive unit, 19
  - glow plug LED, 27
  - motor, 6, 19, 27
  - motor LED, 27
  - plug, 6, 19
    - glow plug wire, 19
    - ground wire, 19
    - negative wire, 19
    - positive wire, 19
  - Protection mode, 27
  - Smart Start, 26
  - using, 27
- Fit, 20
- Flag color, 10
- Flame-out, 20
- Flipping, 33
- Flywheel, 19
- Frequency band, 10
- Fuel, 4, 5, 20, 22, 41
  - break-in, 28
  - dispensing bottle, 5, 22
  - flow, 24
  - handling, 22
  - other fuels, 22
  - unburned, 27, 30
- Fuel intake, 19
- Fuel line (fuel tubing), 6, 19, 20, 27
- Fuel mixture, 20
- Fuel mixture needles, 24

- Fuel tank, 6, 19
  - filling*, 22
- Fuel Cap, 6
- Gear ratio, 44
- Glow plug, 21
  - driver*, 21
  - fouled*, 28
  - glow plug wire*, 19, 27
  - igniter*, 26
- Half shaft, 6
- Head (cylinder head), 19, 20
- Head protector, 19
- Header, 6, 21
- High-speed needle, 19, 21, 24
  - adjustment*, 25, 30
- Humidity, 31
- Idle speed, 21
- Idle speed screw, 19, 21
  - adjustment*, 25, 31
- Jumping, 33
- Lean, 21
  - "leaning the mixture"*, 21
  - maximum safe lean setting*, 30
- Low-speed needle, 19, 21, 24
  - adjustment*, 25, 31
- Lubrication, 22, 25, 32
- Maintenance, 40
  - after-run*, 41
- Moisture, 33
- Multi-tool, 5, 35, 44
- Needle seat, 24
- Needle valve, 21
- Neutral position, 10
- Nitromethane (nitro), 21
  - content*, 21, 22
  - percentage*, 22, 31
- O-ring, 21
- Obstacles, 33
- On/Off switch (receiver), 6, 9, 16
- OptiDrive, 6, 9, 10
  - programming*, 15
- Pinch test, 31
- Pipe, 6, 19, 21
  - tuned*, 21
- Pipe hanger, 6
- Piston, 21
  - maintenance*, 40
- Pivot balls, 6
  - adjusting pivot ball caps*, 35
- Port, 21
- Pressure line, 6, 19
- Punch, 21
- Push rods, 6
- Quick Start, 7, 8, 11, 12, 13, 16, 17, 22, 26, 27, 28, 30, 33, 40
- Radio interference, 4
- Radio system, 9
  - adjustments*, 14
  - controls*, 14
  - rules*, 16
  - terminology*, 10
- Range, 9, 12, 13, 16
- Receiver, 6, 9, 10, 16
- Required equipment, 5
- Reverse, 17, 33
- Rich, 21
- Ride height, 34
- Rockers, 6, 42
  - installing*, 45
- Roll hoop, 6
- Rollover, 33
- RPM, 21
- RX Pack, 10
- Safety, 4, 5, 8, 23, 41
- Servo chart, 15
- Servo reversing switches, 9, 15
- Servo Saver, 39
- Shift button, 9
- Shift rod, 6
- Shifting, 29
- Shifting servo, 6, 9, 10, 17
- Shipping, 3
- Skid plate, 6
- Sleeve, 21
  - maintenance*, 40
- Slipper clutch, 6
  - adjusting*, 37
  - pads*, 40
- Smoke, 30
- Spur gear, 6, 45
  - changing*, 38
  - mesh*, 38
- Steering servo(s), 6, 9, 10, 17, 38
- Steering system, 38
  - adjusting*, 38
  - servo horn link*, 39
- Steering trim, 9, 10, 14
- Steering wheel, 9
- Storage, 40
- Supplies, 5
- Support, 3, 28
- Suspension, 34
  - maximum limits*, 37
  - ride height*, 35
  - rockers*, 42
  - springs*, 34
  - total travel*, 43
  - tuning*, 34
- Suspension arm, 6
- Temperature gauge, 32
- Throttle arm, 19
- Throttle neutral adjust, 9, 14
- Throttle trigger, 9
- Throttle trim, 9, 10, 14, 17, 25, 31
- Throttle/brake servo, 6, 9, 17, 25
- Tire gluing, 8
- Tools, 5
- Transmission, 6, 17
  - basic tuning*, 37
  - gear ratio*, 44
  - two-speed access plug*, 6
  - two-speed adjustment*, 38
  - two-speed ratio*, 44
- Transmitter, 9, 10, 11, 14, 16, 17, 33
  - power indicator*, 9, 11
  - power switch*, 9
- Traxxas Lifetime Engine Replacement Plan, 40
- Trim, 10, see also Throttle trim,
- Steering trim
- Troubleshooting, 28
- Tuning adjustments, 34
  - Advanced*, 42
  - Basic*, 34
- Toe link, 6
- Two-speed, see Transmission
- Wear-in, 21
- Weather conditions, 31
- Wheelies, 30, 33
- Wheels, 8
- Wiring Diagram, 9
- WOT, 21
- Y Adapter, 10



# REVO

TM  
OWNER'S MANUAL

MODEL 5310

**TRAXXAS**®

1100 KLEIN ROAD, PLANO TEXAS 75074  
1-888-TRAXXAS